



DVI KVM HDBaseT™ Extender

w/ USB, RS-232, 2-way Audio, and POH

EXT-DVIKA-HBT2

User Manual

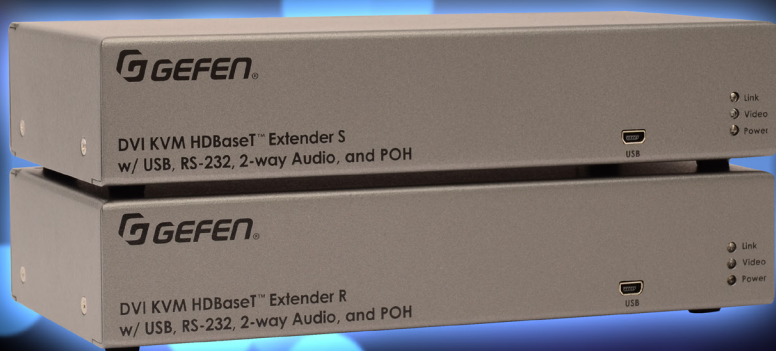

Release A2

Important Safety Instructions

1. Read these instructions.
2. Keep these instructions.
3. Heed all warnings.
4. Follow all instructions.
5. Do not use this product near water.
6. Clean only with a dry cloth.
7. Do not block any ventilation openings. Install in accordance with the manufacturer's instructions.
8. Do not install or place this product near any heat sources such as radiators, heat registers, stoves, or other apparatus (including amplifiers) that produce heat.
9. Do not defeat the safety purpose of the polarized or grounding-type plug. A polarized plug has two blades with one wider than the other. A grounding type plug has two blades and a third grounding prong. The wide blade or the third prong are provided for your safety. If the provided plug does not fit into your outlet, consult an electrician for replacement of the obsolete outlet.
10. Protect the power cord from being walked on or pinched particularly at plugs, convenience receptacles, and the point where they exit from the apparatus.
11. Only use attachments/accessories specified by the manufacturer.
12. To reduce the risk of electric shock and/or damage to this product, never handle or touch this unit or power cord if your hands are wet or damp. Do not expose this product to rain or moisture.
13. Unplug this apparatus during lightning storms or when unused for long periods of time.
14. Refer all servicing to qualified service personnel. Servicing is required when the apparatus has been damaged in any way, such as power-supply cord or plug is damaged, liquid has been spilled or objects have fallen into the apparatus, the apparatus has been exposed to rain or moisture, does not operate normally, or has been dropped.
15. Batteries that may be included with this product and/or accessories should never be exposed to open flame or excessive heat. Always dispose of used batteries according to the instructions.

Warranty Information

Gefen warrants the equipment it manufactures to be free from defects in material and workmanship.

If equipment fails because of such defects and Gefen is notified within two (2) years from the date of shipment, Gefen will, at its option, repair or replace the equipment, provided that the equipment has not been subjected to mechanical, electrical, or other abuse or modifications. Equipment that fails under conditions other than those covered will be repaired at the current price of parts and labor in effect at the time of repair. Such repairs are warranted for ninety (90) days from the day of reshipment to the Buyer.

This warranty is in lieu of all other warranties expressed or implied, including without limitation, any implied warranty or merchantability or fitness for any particular purpose, all of which are expressly disclaimed.

1. Proof of sale may be required in order to claim warranty.
2. Customers outside the US are responsible for shipping charges to and from Gefen.
3. Copper cables are limited to a 30 day warranty and cables must be in their original condition.

The information in this manual has been carefully checked and is believed to be accurate. However, Gefen assumes no responsibility for any inaccuracies that may be contained in this manual. In no event will Gefen be liable for direct, indirect, special, incidental, or consequential damages resulting from any defect or omission in this manual, even if advised of the possibility of such damages. The technical information contained herein regarding the features and specifications is subject to change without notice.

For the latest warranty coverage information, refer to the Warranty and Return Policy under the Support section of the Gefen Web site at www.gefen.com.

Technical Support

(707) 283-5900 (800) 472-5555
8:00 AM to 5:00 PM Monday - Friday, Pacific Time

Email

support@gefen.com

Web

<http://www.gefen.com>

Mailing Address

Gefen
Core Brands, LLC
c/o Customer Service
1800 S McDowell Blvd
Petaluma, CA 94954 USA

Product Registration

Register your product here: <http://www.gefen.com/kvm/Registry/Registration.jsp>

Operating Notes

- Always make sure that this product is running the latest firmware. The Gefen Syner-G™ Software Suite is a free downloadable application from Gefen that provides automatic download and installation of firmware upgrades for this product.

Download the application here: <http://www.gefen.com/synerg/>

- This product is only compatible with Gefen Syner-G 2.1.x and later, in order to support EDID management and firmware updates.

DVI KVM HDBaseT™ Extender w/ USB, RS-232, and POH is a trademark of Gefen, LLC.

© 2016 Core Brands, LLC. All Rights Reserved. All trademarks are the property of their respective owners.

Gefen, LLC reserves the right to make changes in the hardware, packaging, and any accompanying documentation without prior written notice.



This product uses UL listed or CE-compliant power supplies.

Features

- Extends DVI, USB, RS-232, and 2-way Audio over a single CAT-5e
 - 1080p Full HD (1920 x 1080 @ 60Hz, 4:4:4, 12-bit), up to 330 feet/100 meters
 - 1080p Full HD (1920 x 1080 @ 60Hz, 4:4:4, 8-bit), up to 495 feet/150 meters
 - WUXGA (1920 x 1200 @ 60Hz, 8-bit), up to 495 feet/150 meters
- Extends HDMI**, USB, RS-232, and 2-way Audio over a single CAT-5e
 - 4K Ultra HD (3840 x 2160 @ 60Hz, 4:2:0, 8-bit), up to 330 feet/100 meters
 - 4K Ultra HD (3840 x 2160 @ 30Hz, 4:4:4, 8-bit), up to 330 feet/100 meters
 - 4K DCI-Cinema (4096 x 2160 @ 30Hz 4:4:4, 8-bit), up to 330 feet/100 meters
 - 1080p Full HD (1920 x 1080 @ 60Hz, 4:4:4, 12-bit), up to 330 feet/100 meters
 - 1080p Full HD (1920 x 1080 @ 60Hz, 4:4:4, 8-bit), up to 495 feet/150 meters
 - WUXGA (1920 x 1200 @ 60Hz, 8-bit), up to 495 feet/150 meters
- HDMI Features Supported:
 - HDMI 2.0 up to 4K 60Hz, 4:2:0, 8-bit color
 - HDCP 2.2 and 1.4
 - 12-bit Deep Color
 - LPCM 7.1 audio, Dolby Atmos®, Dolby® TrueHD, DTS:X™, and DTS-HD Master Audio™ pass-through
 - 3DTV pass-through
 - CEC pass-through
 - Lip Sync pass-through
- Analog L/R Stereo Audio extension from Sender to Receiver and from Receiver to Sender
- Receiver audio input accommodates a microphone or a line level audio source
- POH (Power Over HDBaseT™) feature provides power to Sender unit over the link cable - only the Receiver needs external power
- Advanced EDID Management via Gefen Syner-G™ software
- Link Quality Monitoring via Gefen Syner-G™ software
- In-field firmware update via USB, using Gefen Syner-G™ software
- Locking power connector
- 1U tall, half-rack-width enclosures can be:
 - Surface-mounted
 - Installed in a standard 19-inch rack using the EXT-RACK-1U-GRY rack tray (available separately)
 - Placed on a shelf

** Use Gefen DVI to HDMI cables



1080P
PROGRESSIVE



HDCP 2.2



HDMI 2.0

4K ULTRA HD
60Hz, 4:2:0



Advanced
EDID
Management



Packing List

The DVI KVM HDBaseT™ Extender w/ USB, RS-232, and POH ships with the items listed below. The packing contents of the Sender and Receiver unit are listed below. If any of these items are not present in the box when you first open it, immediately contact your dealer or Gefen.

- 1 x DVI KVM HDBaseT™ Extender w/ USB, RS-232, and POH - Sender unit
- 1 x DVI KVM HDBaseT™ Extender w/ USB, RS-232, and POH - Receiver unit
- 1 x 6 ft. DVI cable (M-M)
- 2 x 6 ft. 3.5mm mini-stereo cable (M-M)
- 1 x 6 ft. Dual-Link DVI cable (M-M)
- 1 x 6 ft. USB A-B cable (M-M)
- 8 x Self-Adhesive Rubber Feet
- 4 x L-Shaped Surface-Mounting Brackets
- 8 x 6mm M3 Phillips flat head machine screws, 0.5mm pitch, for use with EXT-MP-C01
- 4 x 5mm 6-32 Phillips flat head machine screws, for use with EXT-RACK-1U
- 1 x 48V/1A DC power supply with locking plug
- 1 x IEC AC power cord with interchangeable connectors (US, UK, EU, AU)
- 1 x Quick-Start Guide

1 Getting Started

Introduction.....	2
Sender Unit	2
Receiver Unit.....	4
Installation	7
Connection Instructions.....	7
Application Diagram	8

2 Basic Operation

LED Status	12
Audio Connections	13
DIP Switch Configuration	15
EDID Management.....	16
EDID Lock	17
HDCP	17
Long-Reach Mode.....	18
RS-232 Interface	19
RS-232 Interface	19

3 Advanced Operation

Using Syner-G™	24
Verifying the USB Driver	24
Downloading an EDID.....	26
Uploading an EDID	29
Copying an EDID	31
Viewing an EDID	33

4 Appendix

Default Settings.....	40
Sender Unit DIP Switches.....	40
Receiver Unit DIP Switches	40
Updating the Firmware.....	41
Network Cable Diagram	47
Rack Tray Installation.....	48
Specifications	49
Index.....	51

This page left intentionally blank.

This page left intentionally blank.

DVI KVM HDBaseT™ Extender

w/ USB, RS-232, 2-way Audio, and POH

1 Getting Started

Sender Unit

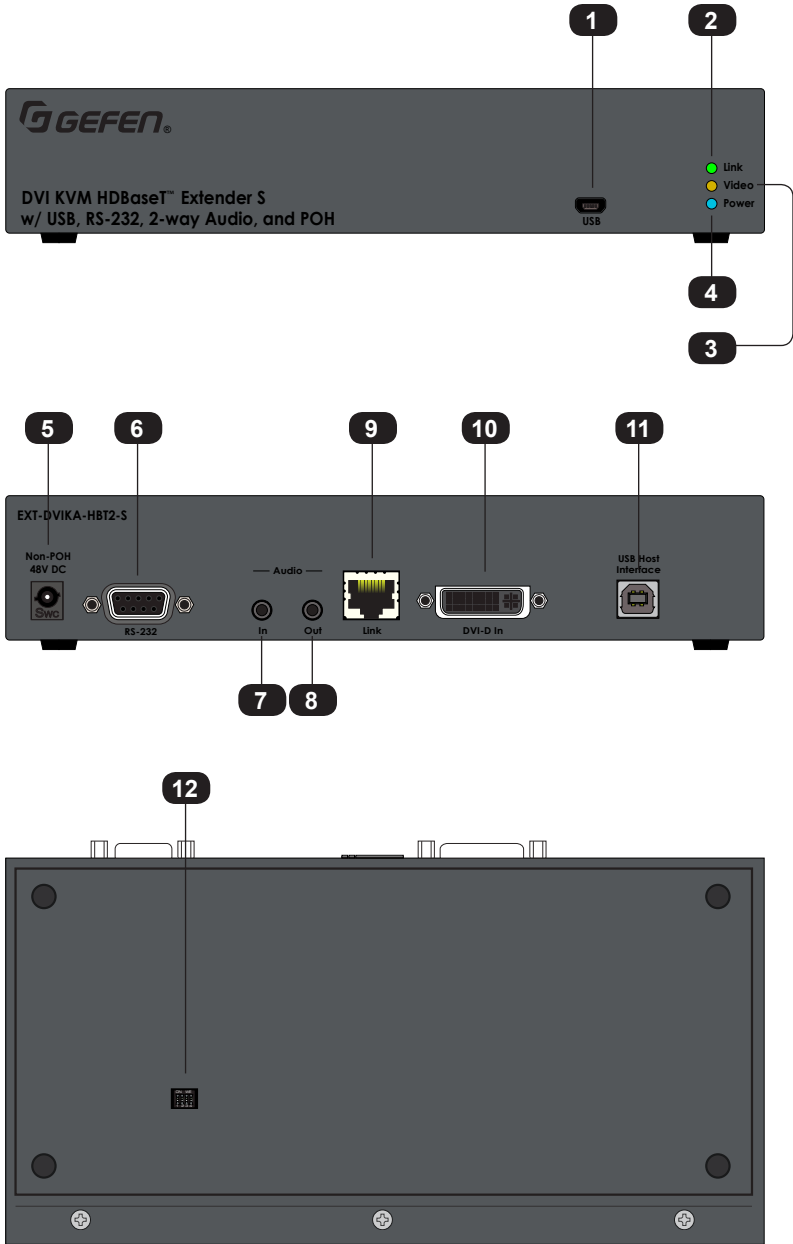

ID	Name	Description
1	USB	Connect the included USB Type A to Mini-USB Type B cable to this connector. This connector provides firmware updates and control using the Syner-G software.
2	Link	This LED glows solid green when the Sender unit and Receiver unit are connected and passing video.
3	Video	This LED glows solid amber when the Sender unit and Receiver unit are connected and passing video.
4	Power	This LED glows solid blue when the unit is connected to an AC outlet and the unit is powered ON.
5	Non-POH 48V DC	Use this port only when using a HDBaseT-compatible device as the Receiver.
6	RS-232	Connect the included RS-232 cable from this port to an RS-232 device.
7	Audio In	Connect a 3.5mm mini-stereo cable from the Line Out jack on the multimedia PC to this jack. See Audio Connections (page 13) for more information.
8	Audio Out	Connect a 3.5mm mini-stereo cable from this jack to the Line In jack of a multimedia PC. See Audio Connections (page 13) for more information.
9	Link	Connects the Sender unit to the Receiver unit using shielded CAT-5e (or better) cable.
10	DVI-D In	Connect the included DVI cable from this connector to the DVI source.
11	USB Host Interface	Connect the included USB cable from the computer to this USB port.
12	DIP Switches	Controls various features on this product. See DIP Switch Configuration (page 15) for more information.

Receiver Unit

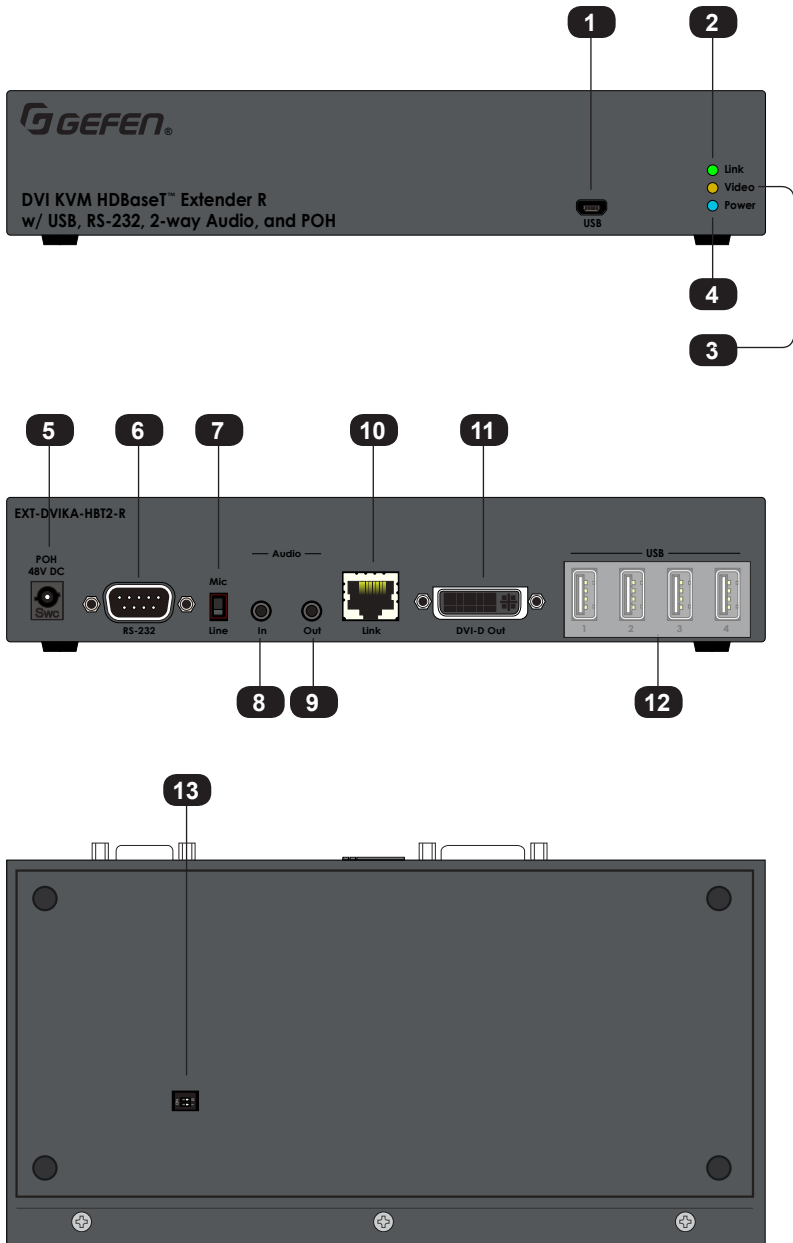

ID	Name	Description
1	USB	Connect the included USB Type A to Mini-USB Type B cable to this connector. This connector provides firmware updates and control using the Syner-G software.
2	Link	This LED glows solid green when the Sender unit and Receiver unit are connected and passing video.
3	Video	This LED glows solid amber when the Sender unit and Receiver unit are connected and passing video.
4	Power	This LED glows solid blue when the unit is connected to an AC outlet and the unit is powered ON.
5	POH 48V DC	Connect the included power supply to this power connector. The Sender unit is powered over the CAT-5e (or better) cable.
6	RS-232	Connect an RS-232 cable from this port to an RS-232 device. See RS-232 Interface (page 19) for more information.
7	Mic / Line	Use this switch to set the Audio In jack to accept line-level or mic-level input signals.
8	Audio In	Connect a 3.5mm mini-stereo cable from the Line Out jack on the multimedia PC to this jack. See Audio Connections (page 13) for more information.
9	Audio Out	Connect a 3.5mm mini-stereo cable from this jack to the Line In jack of a multimedia PC. See Audio Connections (page 13) for more information.
10	Link	Connects the Receiver unit to the Sender unit using shielded CAT-5e (or better) cable.

ID	Name	Description
11	DVI-D Out	Connect a DVI cable from this connector to the DVI display.
12	USB (1, 2, 3, 4)	Connect up to four USB devices to these USB ports.
13	DIP Switches	Controls various features on this product. See DIP Switch Configuration (page 15) for more information.

Connection Instructions

▶ Video

1. Connect the included DVI cable from the DVI source to the **DVI-D In** port on the Sender unit.
2. Connect a display to the **DVI-D Out** port on the Receiver unit.



Tip

An HDMI cable can be connected to the output when using a Gefen DVI to HDMI cable (Gefen part no. CAB-DVI2HDMI-LCK-06MM).

▶ Link

3. Connect a shielded CAT-5e (or better) cable from the **Link** port on the Sender unit to the **Link** port on the Receiver unit.

Maximum Resolution	Mode	Distance
HDMI <ul style="list-style-type: none"> • 1920 x 1080p 60 Hz (8-bit) 	Long Reach mode	495 feet (150 meters)
DVI <ul style="list-style-type: none"> • 1920 x 1200 60 Hz 		
HDMI <ul style="list-style-type: none"> • 3840 x 2160p 60 Hz (4:2:0) 	Normal mode	330 feet (100 meters)
DVI <ul style="list-style-type: none"> • 1920 x 1200 60 Hz 		

See [Long-Reach Mode \(page 18\)](#) for more information.

▶ Audio (see [Audio Connections \(page 13\)](#) for more information)

4. Connect a 3.5mm mini-stereo cable from the **Audio In** port on the Sender unit to the audio source.
5. Connect a pair of powered speakers (or another audio output device) to the **Audio Out** port on the Receiver unit.
6. Connect a line-level or mic-level input to the **Audio In** port on the Receiver unit. If using a mic-level input, then set the **Mic / Line** switch, on the Receiver unit, to the **Mic** position.

7. Connect a 3.5mm mini-stereo cable from the **Audio Out** port on the Sender unit to the audio input on the computer.



Warning

If a line-level input is being connected, DO NOT connect the cable to the "Mic In" port on the computer. Doing so may damage the sound card on the computer.

► USB

8. Connect the included USB cable from the computer to the **USB Host Interface** port on the Sender unit.
9. Connect up to four USB devices to the Receiver unit.

► Power

10. Connect the included power supply to the Receiver unit.

Application Diagram

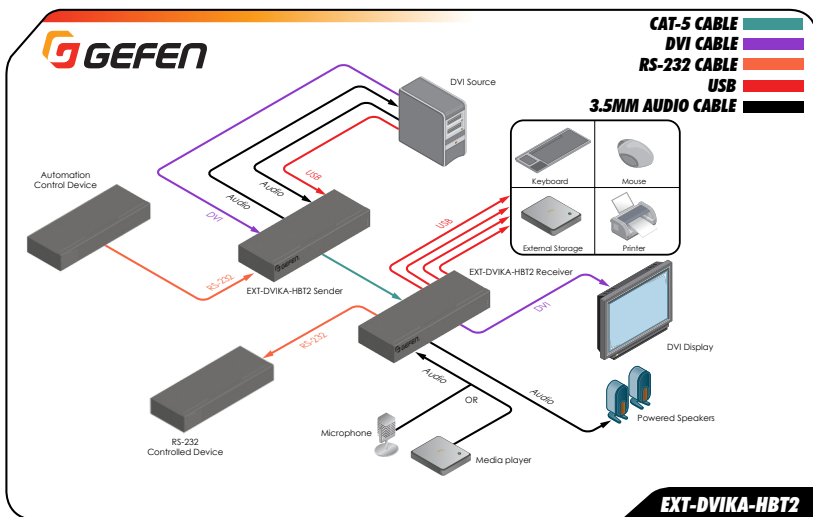

This page left intentionally blank.

This page left intentionally blank.





DVI KVM HDBaseT™ Extender

w/ USB, RS-232, 2-way Audio, and POH

2 Basic Operation

The **Link, Video, and Power** LED indicators provides basic information on the current status of the this product.

The information, in the table below, applies to both the Sender and Receiver unit.

LED	Status	Description
Link	 Solid green	<ul style="list-style-type: none">The Sender / Receiver unit is powered.Link integrity between Sender and Receiver unit is good.
	 Flashing amber	<ul style="list-style-type: none">Non-HDCP content is detected.
Video	 Solid amber	<ul style="list-style-type: none">HDCP content is detected
	 Flashing amber	<ul style="list-style-type: none">Non-HDCP content is detected.
Power	 Solid blue	<ul style="list-style-type: none">The Sender / Receiver unit is powered.

The DVI KVM HDBaseT™ Extender can accept either Mic or Line-level inputs on the Receiver unit. Use the **Mic / Line** switch to set the proper input level.

1. Locate the **Mic / Line** switch, next to the **Audio In** port, and set the switch to the desired audio input type. If connecting a microphone, then set the **Mic / Line** switch to the **Mic** position. Otherwise, set the switch to the **Line** position.
2. Connect the 3.5mm mini-stereo jack from the audio source to the **Audio In** port on the Receiver unit.

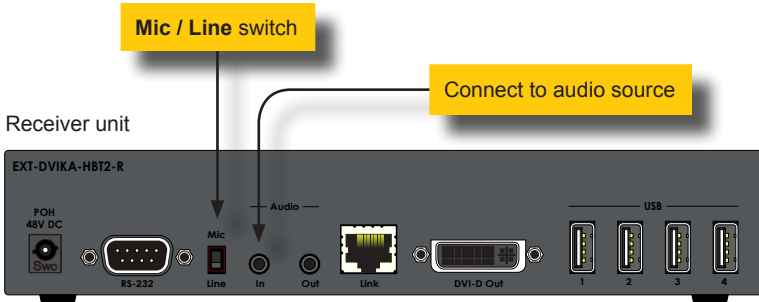

3. In order to get the audio from the Receiver unit to the computer, connect a 3.5mm mini-stereo cable from the **Audio Out** port on the Sender unit to the **Line In** jack on the computer.

Warning

 If you are using a line-level input, **DO NOT** connect the cable to the "Mic In" port on the computer; doing so will result in audio "clipping" and may cause damage to the computer's sound card.

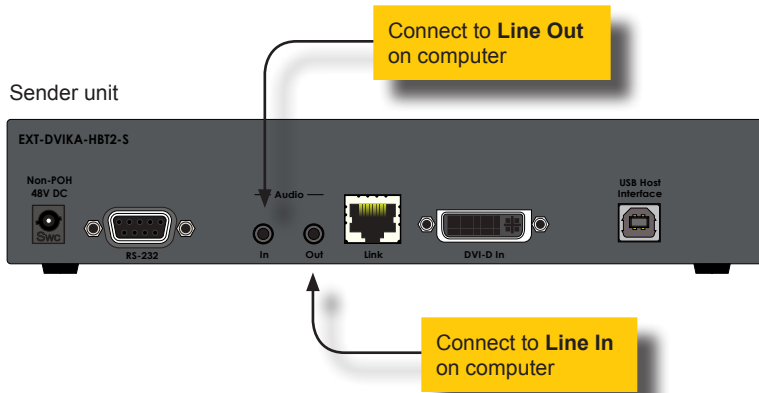

4. Connect another 3.5mm-to-3.5mm mini-stereo cable between the **Audio Out** jack on the computer and the **Audio In** jack on the Sender unit. Note that any audio device (e.g. MP3 player, etc.) can be connected to the **Line In** jack on the Sender unit.
5. Finally, we'll connect a set of powered computer speakers to the **Audio Out** jack on the Receiver unit.

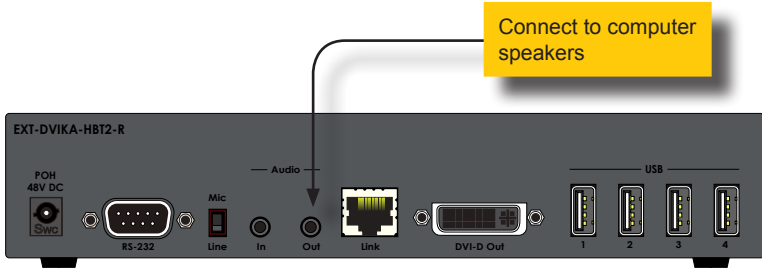

In the diagram below, the USB devices have been removed from the Sender and Receiver unit, for purposes of clarity. Arrowheads indicate the audio signal path.

Figure 2.1 - Speaker and audio connections

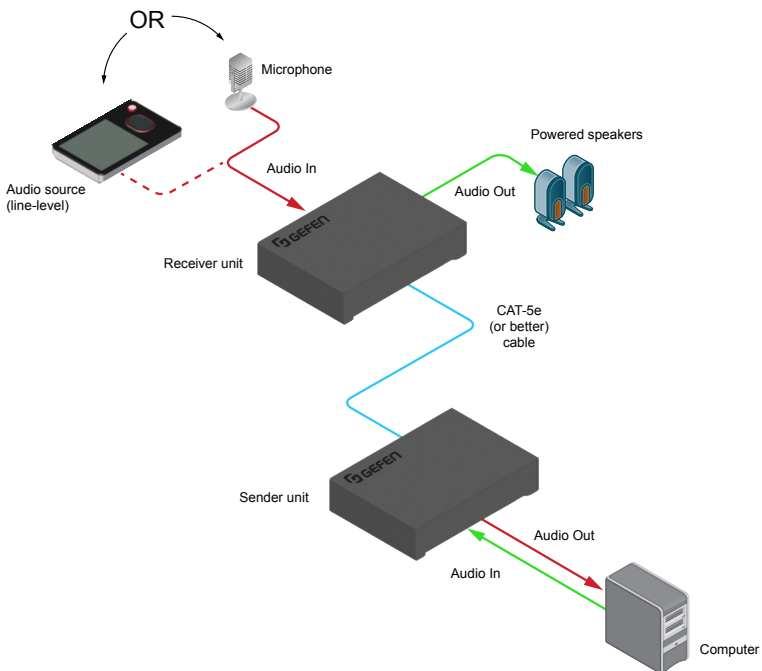

DIP Switch Configuration

On the bottom of both the Sender and Receiver unit are a bank of DIP switches. The Sender unit has 4 DIP switches and the Receiver unit has two.

Remove the gray tape on the bottom of the unit to expose the DIP switches.

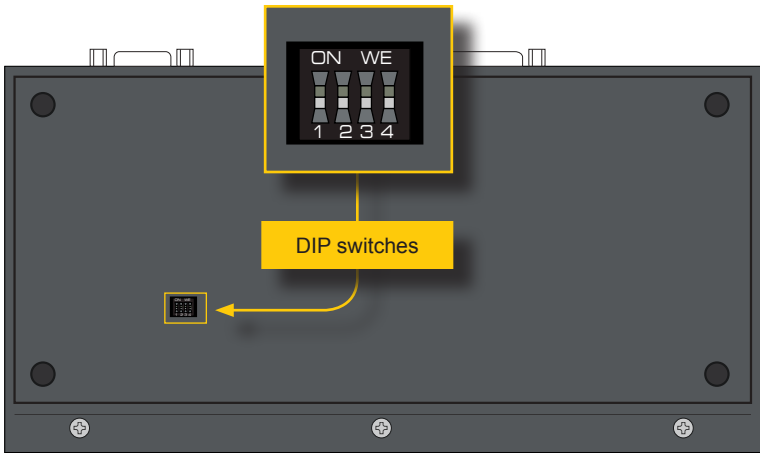

Sender unit

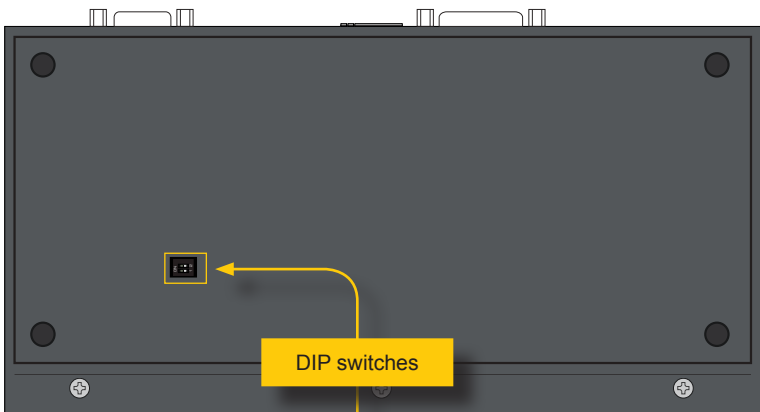

Receiver unit

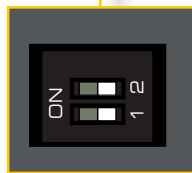

EDID Management

Each of the following sections describe the DIP switch settings that control each feature. DIP switches that are not related to a specific feature have been grayed-out. Note that DIP switch settings can be used independently or in conjunction with other features, as desired.



Information



DIP switch 2, on the Receiver unit, is not used and is reserved for optional future expansion.

This product provides EDID management. The Sender unit can use the EDID from the sink device (downstream EDID) or the built-in default EDID.

Description	Sender unit	Receiver unit
<p>Local EDID mode (default)</p> <ul style="list-style-type: none"> Copies the downstream EDID locally in HDBT mode. Modifies downstream EDID to support only up to 1080p60 8-bit in Long Reach mode. 		
<p>Pass-Through EDID mode</p> <ul style="list-style-type: none"> Allows all video and audio features of the connected device to be passed to the source device. 		

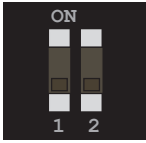

EDID Lock

The EDID lock feature prevents the currently stored EDID from being overwritten.

Description	Sender unit	Receiver unit
<p>EDID Unlock (default)</p> <ul style="list-style-type: none"> The existing EDID is replaced with another EDID when the unit is powered. The EDID can be from a downstream sink, a local EDID, or an EDID that is uploaded using the Syner-G™ software. 		
<p>EDID Lock</p> <ul style="list-style-type: none"> Locks the current EDID and prevents it from being overwritten. 		



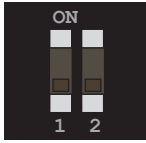

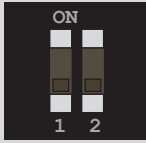
HDCP

This feature allows HDCP content to either be passed-through or disabled on the input. Disabling this feature *does not* decrypt HDCP content.

Description	Sender unit	Receiver unit
<p>HDCP Enable (default)</p> <ul style="list-style-type: none"> Allows HDCP content to pass-through from the source. 		
<p>HDCP Disable</p> <ul style="list-style-type: none"> Disables HDCP content from being passed-through from the source. 		

Long-Reach Mode

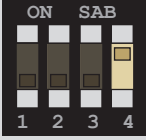
When set to long reach mode, resolutions up to 1920 x 1200 @ 60 Hz can be extended up to 495 feet (150 meters).

Description	Sender unit	Receiver unit
<p>HDBT mode (default)</p> <ul style="list-style-type: none"> HDMI: Allows resolutions up to 3840 x 2160p 60 Hz @ 4:2:0 to be extended up to 330 feet (100 meters). DVI: Allows resolutions up to 1920 x 1200 60 Hz to be extended up to 330 feet (100 meters). 		
<p>Long-reach mode</p> <ul style="list-style-type: none"> DVI: Allows resolutions up to 1920 x 1200 60 Hz, to be extended to a maximum distance of 495 feet (150 meters). 		

RS-232 Interface

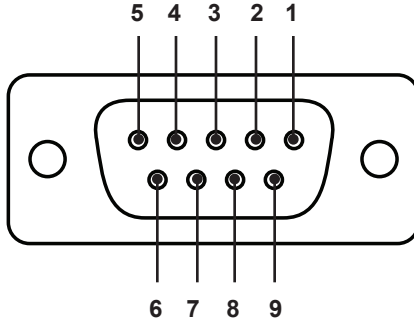

Automation Device

Extender

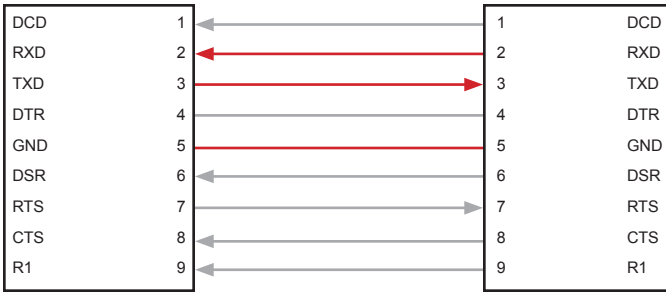

Only TXD, RXD, and GND pins are used.

This product supports RS-232 pass-through, allowing the control of remote RS-232 devices.

In the example below, an RS-232 device has been connected to the Receiver unit. Connect the automation control device to the Sender unit.

Figure 2.1 - Basic RS-232 connection

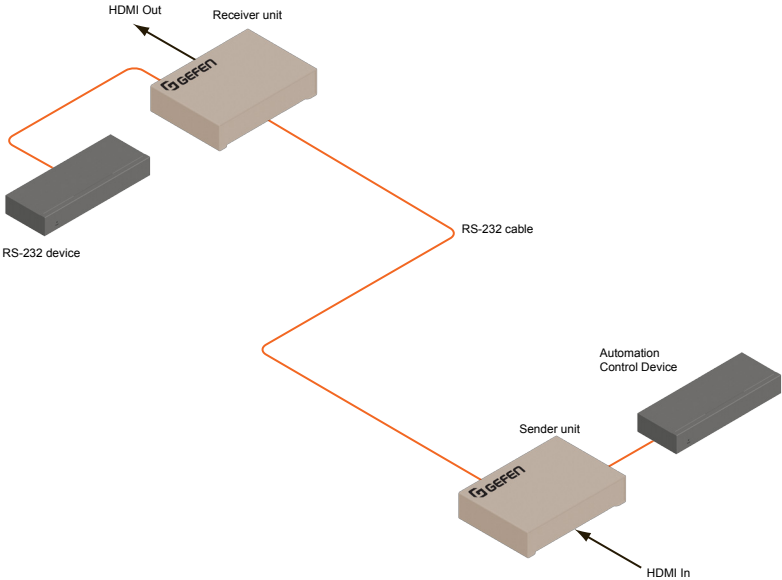

This page left intentionally blank.

This page left intentionally blank.

DVI KVM HDBaseT™ Extender

w/ USB, RS-232, 2-way Audio, and POH

3

Advanced Operation

Verifying the USB Driver

In order to use this product with the Gefen Syner-G™ software, a USB driver must be installed on the computer that is running the Syner-G™ software. This driver is automatically installed when the Syner-G™ Software Suite is installed.

1. Download and install the Gefen Syner-G™ Software Suite. The Syner-G™ software can be downloaded here: <http://www.gefen.com/synerg/>
2. Connect a mini-USB-to-USB cable (not included) from the **USB** port on the front of the Sender or Receiver unit to an available USB port on the computer.
3. From the Windows Desktop, click the **Start** button, select **Computer**, then right-click and select **Manage** from the context menu.

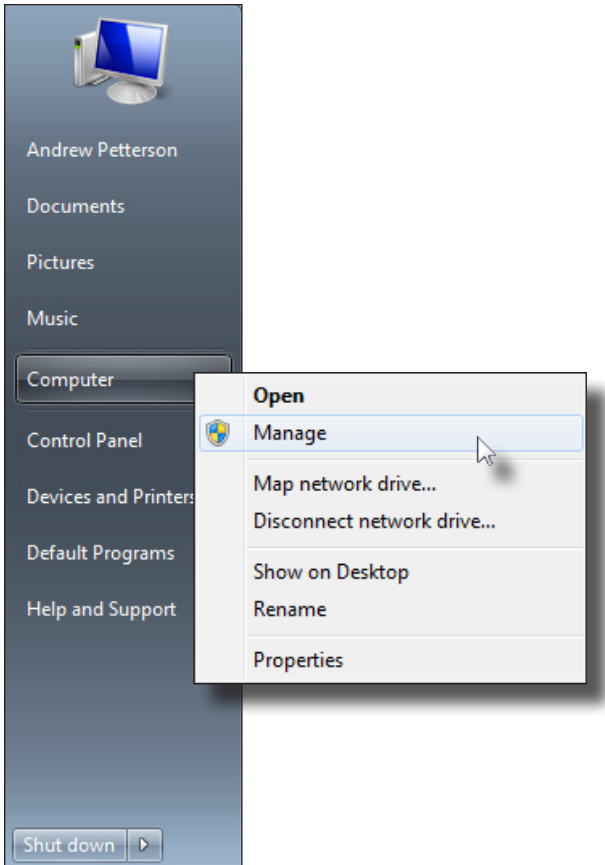

4. The **Computer Management** window will open.
5. In the left window pane, under **System Tools**, click **Device Manager**.
6. In the right window pane, locate **Ports (COM & LPT)**.

The device driver will be displayed. In this case, **EXT-DVIKA-HBT2-S** will be displayed. If the USB cable is connected to the Receiver unit, then the device driver will be **EXT-DVIKA-HBT2-R**.

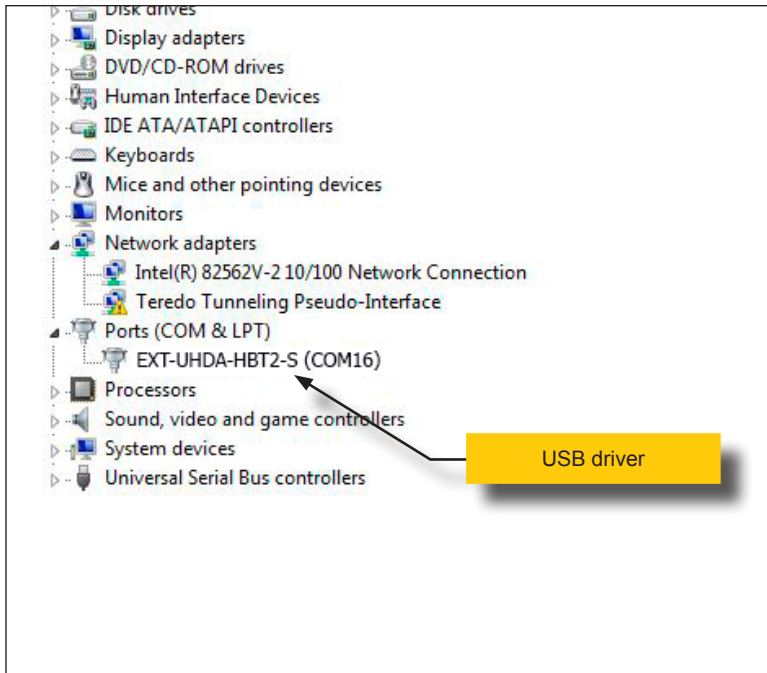

Downloading an EDID

EDID data can be downloaded from the connected Gefen Detective device to a local file. Note that the Downstream EDID or Bank EDID data cannot be downloaded to a file. To download this EDID data, it must first be copied to the Local EDID. See [Copying an EDID \(page 31\)](#) for more information on copying EDID data.

1. Click the **Manage a Product** button and select the connected product from the drop-down list.
2. Click the **Manage EDID** tab.

The screenshot displays the software interface for managing EDID data. At the top, there is a 'Select Function' section with three buttons: 'Discover and Configure IP', 'Manage a Product' (highlighted in red), and 'EDID Editor'. Below this is a 'Select Product' dropdown menu showing 'EXT-UHDA-HBT2-S, COM16'. A tabbed interface below the product selection has three tabs: 'Status', 'Manage EDID' (which is selected and has a mouse cursor over it), and 'Update'. The main content area under the 'Manage EDID' tab is titled 'Version Info' and contains a text box with the following information: 'EXT_UHDA_HBT2_S', 'Release version: 1.00', 'Release date: Nov 2 2015', and 'Release time: 13:06:29'. Below the version info is a row of controls including a 'Select EDID From Device' dropdown, a 'Save As' button, and a 'View' button. A larger red-bordered box contains two rows of controls: the first row has 'Upload EDID to' with a 'Local EDID' dropdown, an empty text input, and 'Browse' and 'Upload' buttons; the second row has 'Copy EDID from' with a 'Down Stream' dropdown, the word 'to', another 'Local EDID' dropdown, and a 'Copy' button. At the bottom, there is an 'EDID Mode' section with 'Internal' and 'Custom' buttons.

- Information about the currently selected device will be displayed in the **Version Info** field.

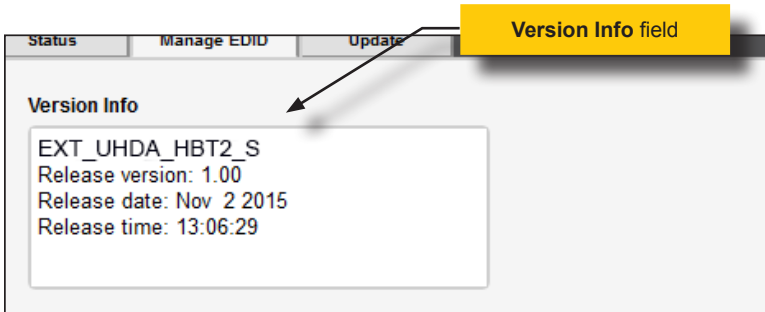

- Click the drop-down list next to the **Download** button, and select the desired EDID. In this example, we will select `Extender: Local EDID`.

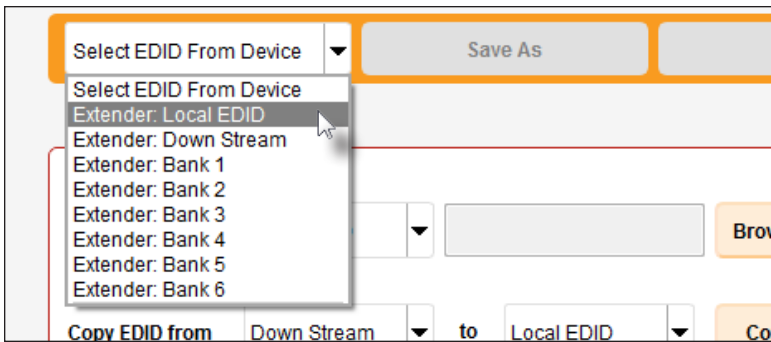

- Click the **Save As** button.



- The Windows **Save File** dialog will be displayed. Select the desired folder and specify the name of the file in the **File name** field, within the **Save File** dialog. Make sure to specify the `.bin` extension to the filename.

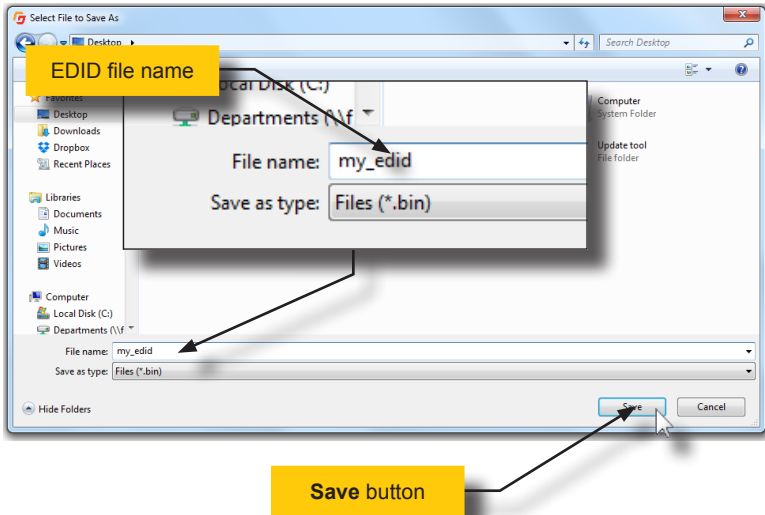

7. Click the **Save** button.

Uploading an EDID

1. Click the **Manage a Product** button and select the connected product from the drop-down list.
2. Click the **Manage EDID** tab.
3. Click the **Upload EDID to** drop-down list to select the location where the EDID will be uploaded. The EDID can be uploaded to the Local EDID or an EDID bank.

In the example below, we will select **Local EDID**.

The screenshot shows a web interface for managing EDID. At the top, there is a header bar with a dropdown menu labeled "Select EDID From Device", a "Save As" button, and a "View" button. Below this, the main content area is divided into two sections. The first section, labeled "Upload EDID to", has a dropdown menu currently open, showing options: "Local EDID", "Bank 1", "Bank 2", "Bank 3", "Bank 4", "Bank 5", and "Bank 6". A mouse cursor is pointing at "Local EDID". To the right of this dropdown is a text input field and a "Browse" button. The second section, labeled "Copy EDID from", has a dropdown menu with "Local EDID" selected, followed by a "to" label, another dropdown menu with "Local EDID" selected, and a "Copy" button.

4. Click the **Browse** button.

This screenshot shows the same interface as the previous one, but the "Upload EDID to" dropdown menu is now closed and "Local EDID" is selected. The mouse cursor is now clicking on the red "Browse" button. The "Copy EDID from" section remains the same, with "Down Stream" selected in the first dropdown and "Local EDID" in the second.

- The Windows **Select File** dialog will be displayed.
- Select the desired EDID file. The EDID file must be in `.bin` format.
- Click the **Open** button.

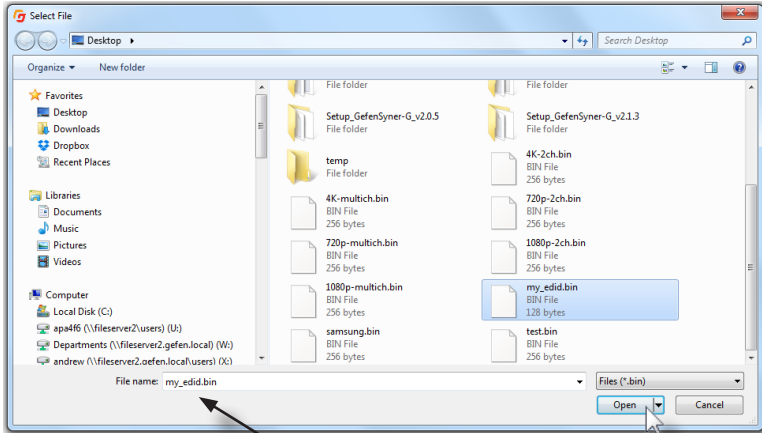

File name: `my_edid.bin`

- Click the **Upload** button.

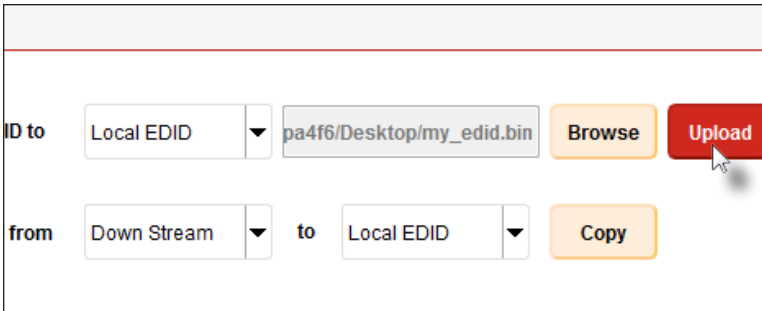

- In the lower-left corner of the interface, the “Uploading...” message will appear as the EDID is uploaded. Once the operation is complete, the “Upload Complete.” message will be displayed.

Uploading...

Upload Complete.

Copying an EDID

1. Click the **Manage a Product** button and select the connected product from the drop-down list.
2. Click the **Manage EDID** tab.
3. Click the **Copy EDID from** drop-down list to select the location from where the EDID will be copied. The EDID can be copied from any of the following locations: The downstream EDID, an EDID bank, or a default EDID location

In the example below, we will select **Down Stream**.

The screenshot shows a web interface for managing EDID. It features three main sections:

- Upload EDID to:** A dropdown menu set to 'Local EDID' with a 'Browse' button to its right.
- Copy EDID from:** A dropdown menu currently open, showing options: 'Down Stream', 'Bank 1', 'Bank 2', 'Bank 3', 'Bank 4', 'Bank 5', 'Bank 6', 'Default EDID 1', 'Default EDID 2', and 'Default EDID 3'. A mouse cursor is pointing at 'Down Stream'.
- to:** A dropdown menu set to 'Local EDID' with a 'Copy' button to its right.
- EDID Mode:** A section with a 'Custom' button.

4. Click the **Copy EDID to** drop-down list to select the location to where the EDID will be copied. The EDID can be copied to the Local EDID or to an EDID bank.

This screenshot shows the same interface as the previous one, but with the 'Copy EDID to' dropdown menu open. The options are: 'Local EDID', 'Bank 1', 'Bank 2', 'Bank 3', 'Bank 4', 'Bank 5', and 'Bank 6'. A mouse cursor is pointing at 'Local EDID'. The 'EDID Mode' section now shows an 'Internal' button instead of 'Custom'.

- Click the **Copy** button.

The screenshot shows a configuration interface for EDID. It includes two rows of controls:

- Upload EDID to:** A dropdown menu set to "Local EDID" followed by an empty text input field and a yellow "Browse" button.
- Copy EDID from:** A dropdown menu set to "Down Stream", followed by the word "to", another dropdown menu set to "Local EDID", and a red "Copy" button. A mouse cursor is pointing at the "Copy" button.

Below these controls is a section labeled "EDID Mode" with two buttons: "Internal" and "Custom".

- In the lower-left corner of the interface, the “Copying...” message will appear as the EDID is uploaded. The copy-result message will vary, depending upon the copy operation.



In this example, since we copied the downstream EDID to the local EDID, the “Copy result: Downstream stored to local.” message is displayed.

Viewing an EDID

1. Click the **Manage a Product** button and select the connected product from the drop-down list.
2. Click the **Manage EDID** tab.

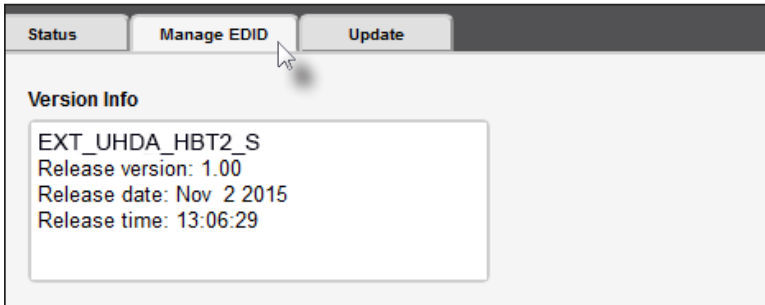

3. Click the **Select EDID From Device / Display** drop-down list to select the desired EDID.

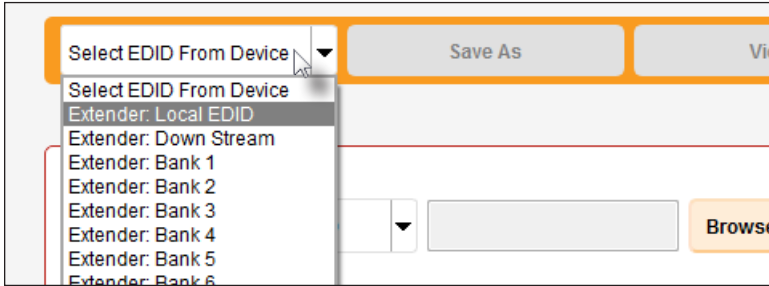

Note that the display, which is connected to the computer, is also available in the drop-down list. In this way, we can download, view, and/or edit the EDID from the display (sink) device.

4. Click the **View** button.



- After a few seconds, Syner-G will also switch to the **EDID Editor** screen. See the Gefen Syner-G™ User Manual for more information on using the EDID Editor.
- Click the desired EDID tab to view specified information on the EDID. Note that some sections within a tab use scroll bars to indicate that more information is available.

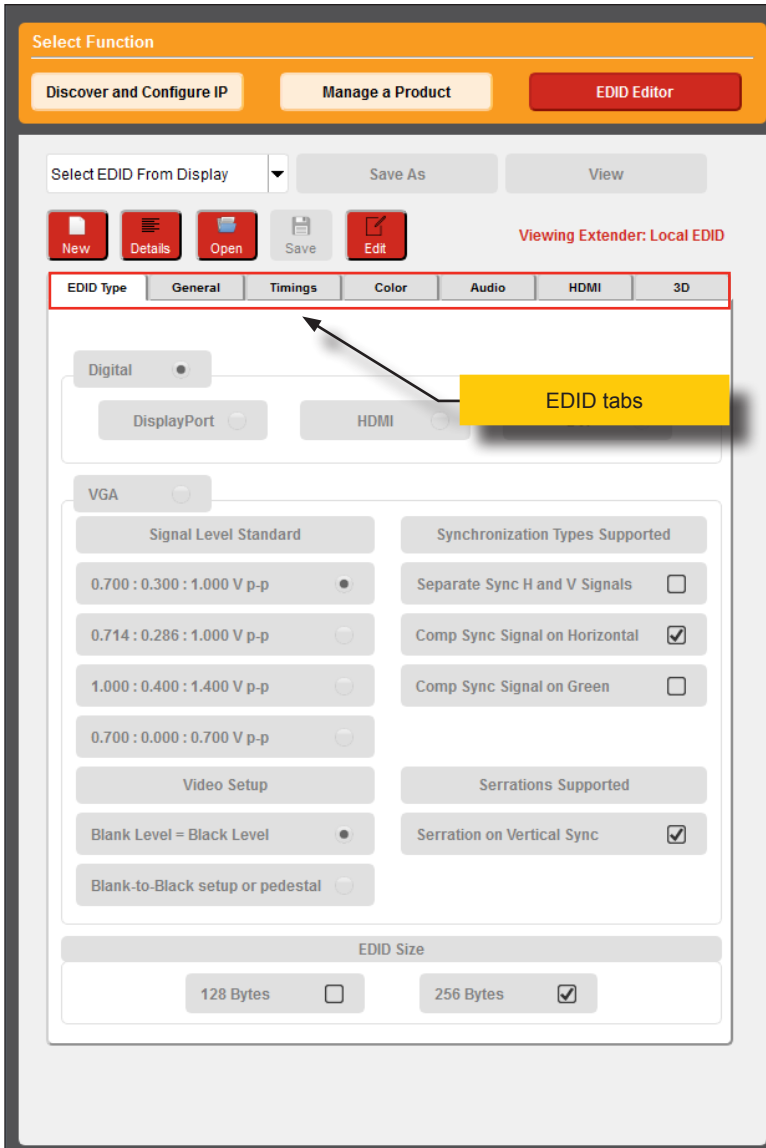

- Click the **Details** button.

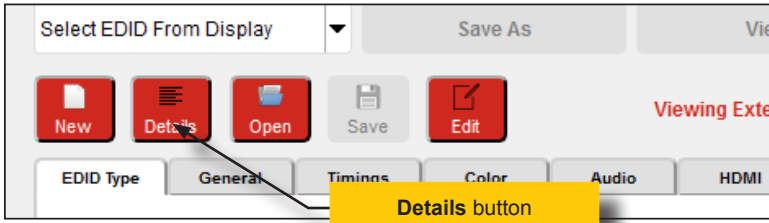

- The **EDID Summary** window will be displayed. Use the horizontal and vertical scroll bar, as needed, to view the EDID information.

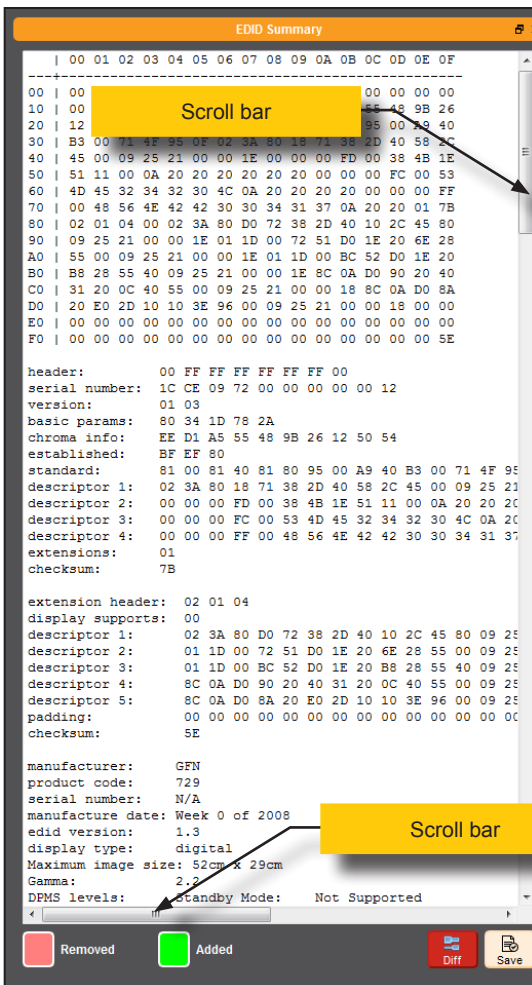

- Click the  button, in the upper-right corner of the **EDID Summary** window to separate the **EDID Summary** window from the main Syner-G window:

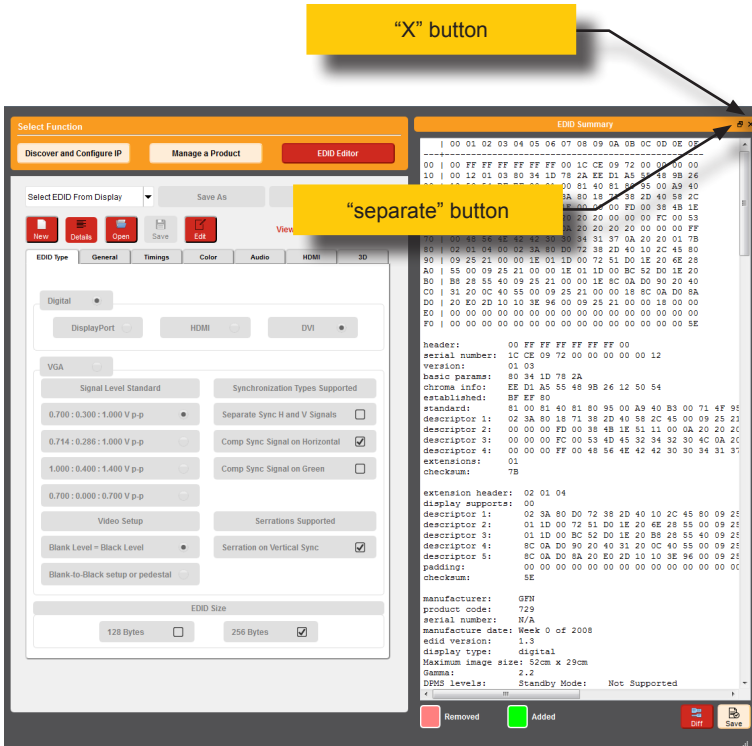

- Double-click the window title bar of the detached EDID Summary window to reattach it to the main window. it to the main Syner-G window.
- To close the **EDID Summary** window, either click the  button, in the upper-right corner of the **EDID Summary** window or click the **Details** button in the main Syner-G window.

This page left intentionally blank.

This page left intentionally blank.

DVI KVM

HDBaseT™ Extender

w/ USB, RS-232, 2-way Audio, and POH

4

Appendix

Sender Unit DIP Switches

DIP switch	Function	Default setting (OFF position)
1	EDID mode	Local EDID
2	EDID lock	Disabled
3	HDCP	Pass-through
4	Long-Reach mode	HDBT mode

Receiver Unit DIP Switches

DIP switch	Function	Default setting (OFF position)
1	Long-Reach mode	HDBT mode
2	N/A	---

The Syner-G™ Software Suite provides an easy way to perform firmware updates. Before launching Syner-G™, make sure that a USB cable is connected between the product and the computer that is running the Syner-G™ software. Refer to the Syner-G™ Software Suite User Manual for more information on using other features with this product.

1. Launch the Syner-G™ Software Suite from the Start Menu or using the shortcut from the Windows Desktop.



2. Click the **Manage a Product** button.

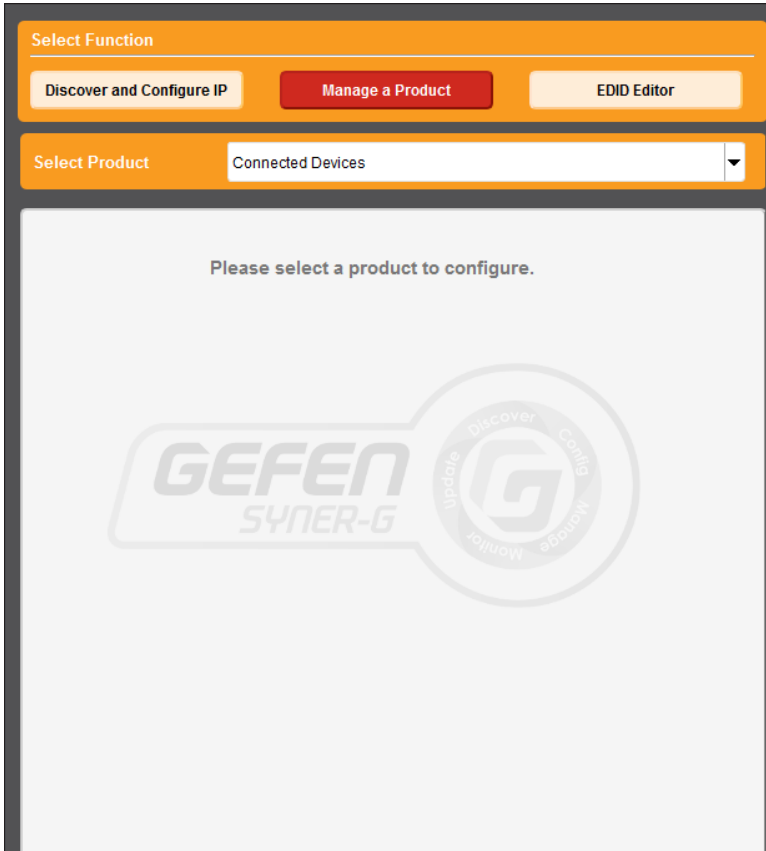

3. Select the product from the **Select your product** drop-down list.

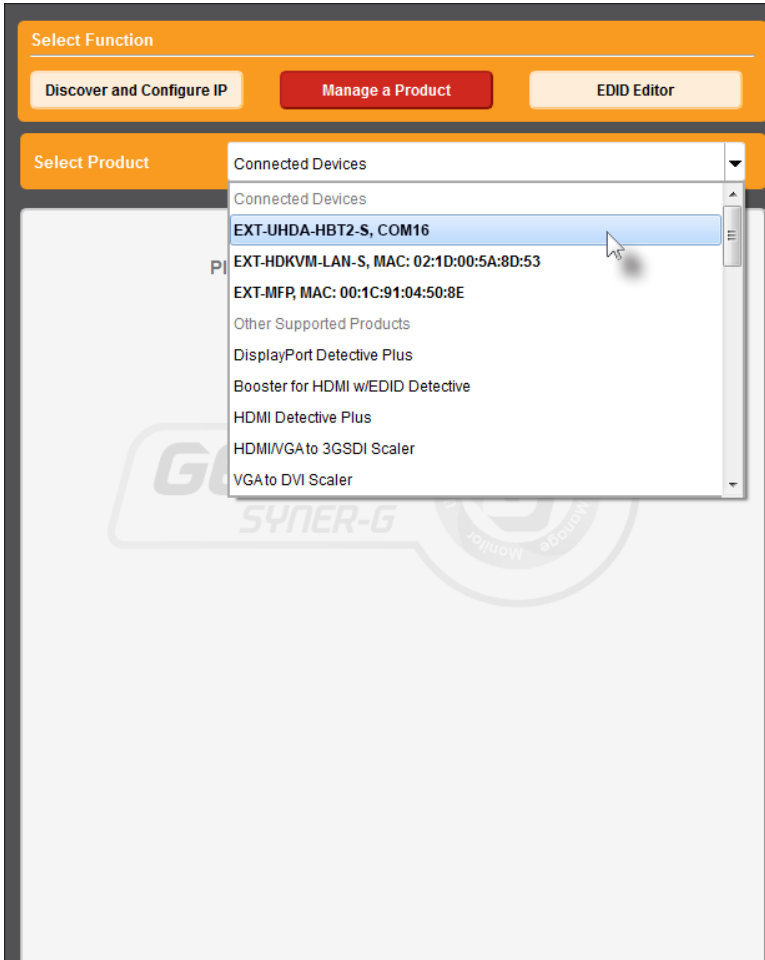

If the product is not detected by Syner-G™, then the product will not be listed in bold type, within the **Select your product** drop-down list. Verify the following:

- ▶ The product is powered and connected to the computer that is running the Syner-G™ Software Suite, using a USB-to-Mini USB cable.
- ▶ Make sure that the USB driver is installed and functioning correctly under Control Panel. See [Verifying the USB Driver \(page 24\)](#) for more information.

4. Click the **Update** tab.

The screenshot displays a web-based interface for managing a product. At the top, there are three buttons: "Discover and Configure IP", "Manage a Product" (highlighted in red), and "EDID Editor". Below this is a "Select Product" dropdown menu showing "EXT-UHDA-HBT2-S, COM16". A navigation bar contains three tabs: "Status", "Manage EDID", and "Update" (which is selected and has a mouse cursor over it). The main content area is divided into several sections:

- Product Information:** "Product: EXT-UHDA-HBT2-S" and "Update Method: USB Serial".
- Firmware Status:** "Current Firmware" and "Latest Firmware" both show "1046024". A red button indicates "Check at Startup Enabled".
- Update Action:** "Last Checked: Fri Dec 4 17:50:31 2015" and a yellow button "Check for Latest Update".
- Notes:** A text area containing "First production firmware."
- Product Options:** A section with the value "None".
- Download and Install:** A section with a progress bar at 0% and buttons for "Start", "Install", and "Save".
- Install from File:** A section with a "Select File to Upload" input field and buttons for "Browse" and "Install".

- Click the **Start** button to begin downloading the firmware.

The screenshot shows the Syner-G™ Software Suite interface for managing a product. The top navigation bar includes 'Discover and Configure IP', 'Manage a Product', and 'EDID Editor'. The 'Select Product' dropdown is set to 'EXT-UHDA-HBT2-S, COM16'. The 'Update' tab is active, showing the product name 'EXT-UHDA-HBT2-S' and 'Update Method: USB Serial'. The current firmware version is 1046024, which matches the latest firmware version. The last check was on Fri Dec 4 17:50:31 2015. The 'Product Options' section shows 'None'. In the 'Download and Install' section, the progress bar is at 0%, and the 'Start' button is highlighted with a mouse cursor. The 'Install from File' section has a 'Select File to Upload' field and a 'Browse' button.

The Syner-G™ Software Suite will automatically download the firmware file for the selected product. This process should take a few seconds.

Once the download process has completed, the progress bar will indicate 100%, as shown on the next page.

A message will also appear at the bottom of the window, indicating that the firmware file was successfully downloaded.

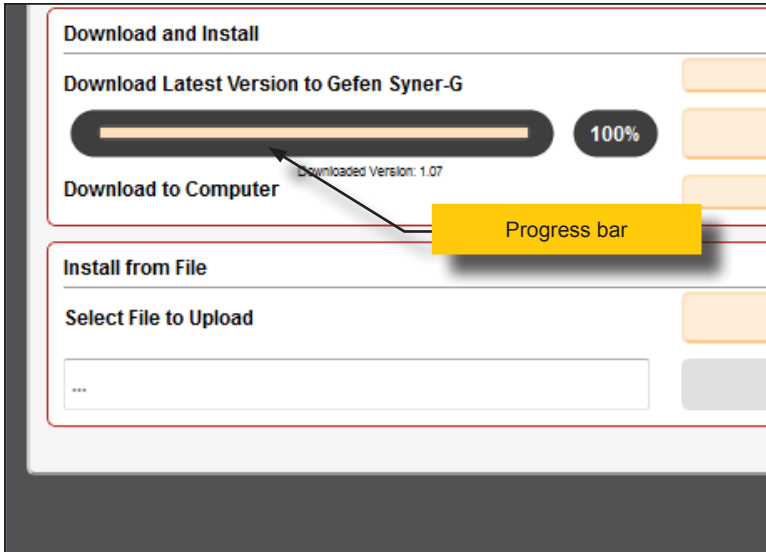

- Click the **Install** button to begin installing the software.

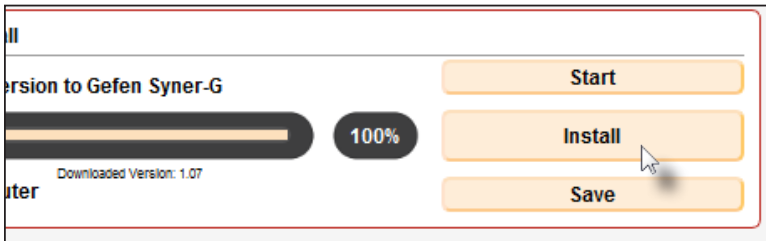

- The installation process will begin and the progress bar will indicate the current status.

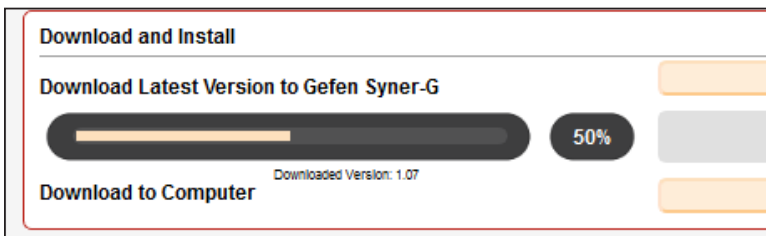

- After the firmware update process has completed, the following message will be displayed.

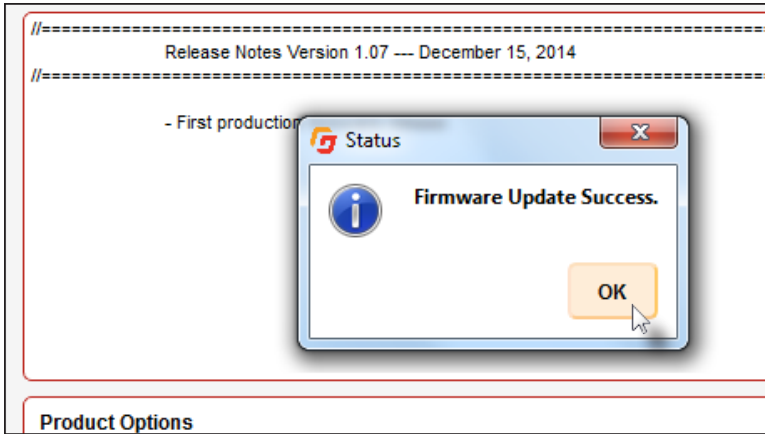

- Click the **OK** button to dismiss the message box.
- The procedure is now complete.

Front of RJ-45 Connector

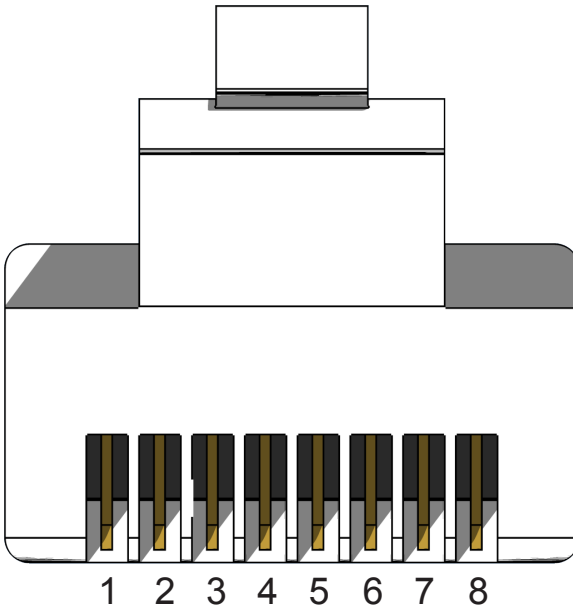

Gefen recommends the TIA/EIA-568-B wiring option. Use the table below when field-terminating cable for use with Gefen products.

Pin	Color	Description
1	Orange / White	TD+ (Transmit Data, positive differential signal)
2	Orange	TD- (Transmit Data, negative differential signal)
3	Green / White	RD+ (Receive Data, positive differential signal)
4	Blue	Unused
5	Blue / White	Unused
6	Green	RD- (Receive Data, negative differential signal)
7	Brown / White	Unused
8	Brown / White	Unused

 **Information**
Shielded CAT-5e (or better) cabling is recommended.

Rack Tray Installation

The following illustrations provide instructions for installing the Sender and/or Receiver unit(s) in the *Gefen 1U Rack Tray* (Gefen part no. EXT-RACK-1U).

Step 1 Turn unit upside down.

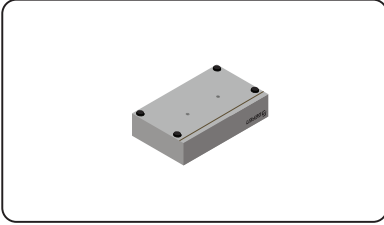

Step 2 Remove rubber feet.

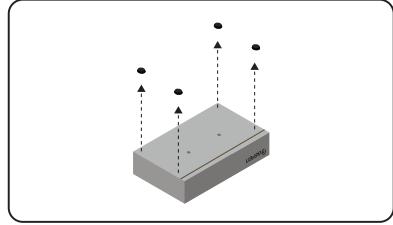

Step 3 Line up holes on unit and rack tray.

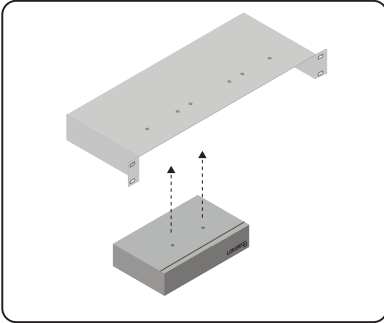

Step 4 Install countersink screws.

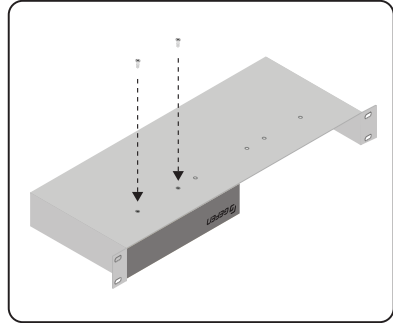

Step 5 Ensure the unit is installed securely.

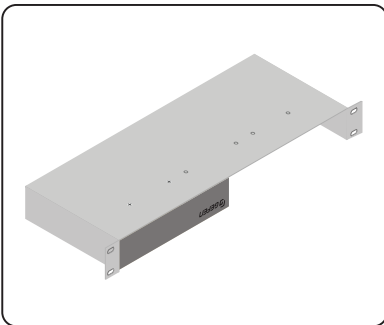

Step 6 Unit has been installed into rack tray.

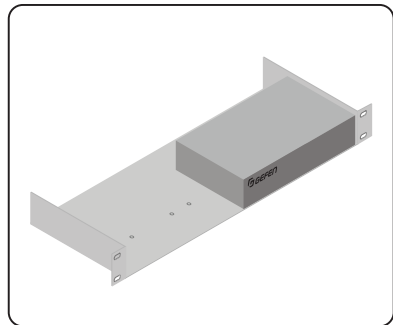

Supported Formats

Resolutions (max.)	<ul style="list-style-type: none"> HDMI 3840 x 2160p 60 Hz (4:2:0) DVI 1920 x 1200 (WUXGA)
--------------------	--

Connectors, Controls, and Indicators

DVI In (Sender)	<ul style="list-style-type: none"> 1 x DVI, 29-pin female, digital only
DVI Out (Receiver)	<ul style="list-style-type: none"> 1 x DVI, 29-pin female, digital only
RS-232 (Sender)	<ul style="list-style-type: none"> 1 x DB-9, female
RS-232 (Receiver)	<ul style="list-style-type: none"> 1 x DB-9, male
Link (Sender / Receiver)	<ul style="list-style-type: none"> 1 x RJ-45, shielded
Audio In (Sender / Receiver)	<ul style="list-style-type: none"> 1 x 3.5mm mini-stereo
Audio Out (Sender / Receiver)	<ul style="list-style-type: none"> 1 x 3.5mm mini-stereo
Non-POH 48V DC (Sender)	<ul style="list-style-type: none"> 1 x 48 V DC power connector
POH 48V DC (Receiver)	<ul style="list-style-type: none"> 1 x 48 V DC power connector
USB Host Interface (Sender)	<ul style="list-style-type: none"> 1 x USB Type B, female
USB Device Connectors (Receiver)	<ul style="list-style-type: none"> 4 x USB Type A, female
USB (Sender / Receiver)	<ul style="list-style-type: none"> 1 x Mini-B type (for Gefen Syner-G)
DIP switches (Sender)	<ul style="list-style-type: none"> 4 x piano type
DIP switches (Receiver)	<ul style="list-style-type: none"> 2 x piano type
Link Indicator (Sender / Receiver)	<ul style="list-style-type: none"> 1 x LED, green
Video Indicator (Sender / Receiver)	<ul style="list-style-type: none"> 1 x LED, amber
Power Indicator (Sender / Receiver)	<ul style="list-style-type: none"> 1 x LED, blue

Operational

Maximum pixel clock	<ul style="list-style-type: none"> 165 MHz
Power input	<ul style="list-style-type: none"> 48 V DC
Power consumption (Sender / Receiver, combined)	<ul style="list-style-type: none"> 13 W
Audio: Sender to Receiver (Line)	<ul style="list-style-type: none"> 2 Vrms < 0.01 % >= 90 dB (20 Hz - 20 kHz) 20 Hz - 20 kHz +/- 0.5 dB
Maximum input voltage	<ul style="list-style-type: none"> 2 Vrms
THD	<ul style="list-style-type: none"> < 0.01 %
SNR	<ul style="list-style-type: none"> >= 90 dB (20 Hz - 20 kHz)
Frequency response	<ul style="list-style-type: none"> 20 Hz - 20 kHz +/- 0.5 dB

Operational	
Audio: Receiver to Sender (Line)	
Maximum input voltage	• 2 Vrms
THD	• < 0.02 % @ 10 k Ω ; 1% @ 32 Ω
SNR	• \geq 85 dB (20 Hz - 20 kHz)
Frequency response	• 20 Hz - 20 kHz +/- 0.5 dB
Audio: Receiver to Sender (Mic)	
Maximum input voltage	• 0.2 Vrms
THD	• < 0.1 %
SNR	• \geq 85 dB (20 Hz - 20 kHz)
Frequency response	• 20 Hz - 20 kHz +/- 0.5 dB
Operating temperature	• +32 to +122 °F (0 to +50 °C)
Operating humidity	• 5% to 90% RH, non-condensing
Storage temperature	• -4 to +185 °F (-20 to +85 °C)
Storage humidity	• 0% to 95% RH, non-condensing
MTBF	• 50000 hours

Physical	
Dimensions (W x H x D) (not including connectors and feet)	• 8.4" x 1.7" x 4.3" (214mm x 43mm x 110mm)
Unit weight (Sender/Receiver)	• 1.1 lbs (0.47 kg) each

A

Application Diagram 8

C

Connection Instructions 7

D

Default Settings

receiver 40*sender unit* 40

DIP Switch Configuration

EDID lock 17*EDID management* 16*HDCP* 17*Long-Reach Mode* 18**E**

EDID

copying 31*downloading* 26*lock* 17*management* 16*uploading* 29*viewing* 33**F**Features *vi*

Firmware

updating 41**H**

HDCP

control 17**L**

LED Status 12

Long-Reach Mode 18

N

Network Cable Diagram 47

OOperating Notes *v***P**Packing List *vi***R**

Rack Tray Installation 48

Receiver Unit 4

SSafety Instructions *ii*

Sender Unit 2

Specifications 49

Syner-G

copying an EDID 31*downloading an EDID* 26*updating the firmware* 41*uploading an EDID* 29*using* 24*viewing an EDID* 33**T**Table of Contents *vii*Technical Support *iv***U**

Updating the Firmware 41

USB Driver

verifying 24**W**Warranty Information *iii*



1800 S McDowell Blvd. Petaluma CA 94954
(707) 283-5900 (800) 472-5555