

*DR*¹²⁸

*12 IN 8 OUT
24-BIT DIGITAL
MIX PROCESSOR*

**ALLEN
&
HEATH**

**INSTALLATION
USER GUIDE**

PUBLICATION AP2973

Limited One Year Warranty

This product has been manufactured in the UK by ALLEN & HEATH and is warranted to be free from defects in materials or workmanship for a period of one year from the date of purchase by the original owner.

To ensure the high level of performance and reliability for which this equipment has been designed and manufactured please read this User Guide before operating.

In the event of a failure notify and return the defective unit to ALLEN & HEATH or its authorised agent as soon as possible for repair under warranty subject to the following conditions:

Conditions of Warranty

1. The equipment has been installed and operated in accordance with the instructions in this User Guide.
2. The equipment has not been subject to misuse either intended or accidental, neglect, or alteration other than as described in the User Guide or Service Manual, or approved by ALLEN & HEATH.
3. Any necessary adjustment, alteration or repair has been made by ALLEN & HEATH or its authorised agent.
4. The defective unit is to be returned, carriage pre-paid, to ALLEN & HEATH or its authorised agent with proof of purchase.
5. Units to be returned should be packed to avoid transit damage.

These terms of warranty apply to UK sales. In other territories the terms may vary according to legal requirements. Check with your ALLEN & HEATH agent for any additional warranty which may apply.

DR128 User Guide AP2973 Issue 3.
Copyright © 1997 Allen & Heath.
All rights reserved.

This Product complies with the European Electromagnetic Compatibility Directives 89/336/EEC and 92/31/EEC and the European Low Voltage Directives 73/23/EEC and 93/68/EEC.



Manufactured in England

ALLEN & HEATH
Kernick Industrial Estate
Penryn
Cornwall TR10 9LU

<http://www.allen-heath.com>

Allen & Heath Agent:

Full Contents

Section 1 - Introduction

Introduction.....	1
Service & Technical Support.....	2
Safety Warning.....	3
Precautions.....	3
Installation.....	4
Connecting Mains Power.....	5
Changing the Fuse or Mains Voltage Setting.....	5
Connecting DC Supplies.....	6
Earthing.....	7

Section 2 - DR128 Overview

Introduction.....	10
Main Features.....	10
Signal Processors.....	10
Basic Principles.....	11
Resource Palettes.....	12
Front Panel Layout.....	13
Front Panel.....	14
Rear Panel Layout.....	15
Rear Panel.....	16

Section 3 - Using the DR128

Front Panel Display.....	18
Auto-Peak.....	18
Patches.....	18
Function Keys.....	19
Function Key Unused.....	20
Function Key as a Level Control.....	20
Patch Select.....	22
Patch Recall.....	23
Remote Switches.....	23
Remote Switch Examples.....	23
Wiring Remote Switches.....	23

ii Contents

Section 4 - Hardware Configuration

Signal Levels.....	26
Mic/Line Inputs.....	27
Setting Mic/Line Input Gain.....	27
Selecting Mic Pad.....	28
Phantom Power.....	28
Line Inputs.....	29
Setting Line Input Gain.....	29
Balanced Outputs.....	31
Setting Output Gain.....	31

Section 5 - Setup Menu

Introduction.....	34
Entering Setup Mode.....	34
Entering the Security Password.....	34
Navigating the Menus.....	35
Exiting Setup Mode.....	35
Menu Map.....	36
1 - Recall Patch.....	37
2 - Save Patch.....	37
3 - Name Patch.....	38
4 - Name Input Channel.....	38
5 - Name Output Channel.....	39
6 - Limiter Setup.....	40
7 - Ducker Setup.....	41
8 - Input Phase.....	43
9 - Output Phase.....	43
10 - Input Level.....	44
11 - Output Level.....	44
12 - Crosspoint Matrix Levels.....	45
13 - Function Key Setup.....	46
14 - Remote Key Setup.....	48
15 - Day of the Week.....	49
16 - Clock.....	50
17 - LCD Contrast.....	50
18 - New Password.....	50
19 - Security.....	51

Section 6 - Appendix

Architect's Specification.....	54
Technical Specifications.....	55
Connecting WinDR.....	56
Resetting the Password.....	60

Introduction

Introduction.....	2
Service & Technical Support.....	2
Safety Warning.....	3
Precautions	3
Installation.....	4
Connecting Mains Power	5
Changing the Fuse or Mains Voltage Setting.....	5
Connecting DC Supplies.....	6
Earthing	7

2 Introduction

Introduction

The DR128 continues Allen & Heath's commitment to provide high quality audio equipment engineered to meet the exacting requirements of today's audio industry. It brings you the latest in high performance technology and offers the reassurance of over two decades of manufacture and customer support.

This user guide presents a guide to the function, application and installation of the DR128. It does not require a remote computer to be connected and running Allen & Heath WinDR software. However to get access to all the features in the DR128 e.g. EQ, Gates, compressors, it is necessary to connect a computer via the RS232 connector and run the WinDR software. For details on connecting and using WinDR please refer to the Appendix section.

For further information on the basic principles of audio system installation and engineering, please refer to one of the specialist publications available.

Whilst we believe the information in this guide to be reliable we do not assume responsibility for inaccuracies. We also reserve the right to make changes in the interest of further product development.

Service & Technical Support

Under normal operating conditions the DR128 does not require user maintenance or calibration. Internal links & preset controls may be set to configure the unit during installation.

To avoid damage to internal components by mishandling and/or misconnection, only technically competent personnel should attempt service & installation work on this unit.



We are able to offer further product support through our worldwide network of approved dealers and service agents. To help us provide the most efficient service please would you keep a record of the unit serial number, the date and place of purchase and quote these in any communication regarding this product.

WARNING TO THE USER, INSTALLATION, SERVICE ENGINEER

Allen & Heath warns that any unauthorised changes or modifications to the DR128 unit may invalidate the legal compliance of the unit and could void the user's authority to operate the equipment.





SAFETY WARNING

Mains electricity is dangerous and can kill. Mains voltage is present within the DR128. Do not remove the top cover with the mains connected. Do not carry out any work within the unit while it is powered except for installation calibration. High voltage components are insulated for safety but should not be touched with power applied. The mains voltage setting is indicated on the rear panel mains socket. Check that this matches your local mains supply voltage. Check your mains wiring and earthing before switching on.



DO NOT REMOVE THE MAINS EARTH CONNECTION

To ensure your safety the mains earth is connected to the chassis through the power lead. Do not remove this connection.

Precautions

- AC Power** Check the rear panel for the correct AC mains voltage setting before switching on.
- Connections** Use audio connectors and cables only for their intended purpose. Do not connect any source of AC or DC power to the DR128's audio connectors. Do not connect the output of power amplifiers directly to the DR128.
- Ventilation** Do not cover the unit in any way. Position the unit in a well ventilated location in the rack.
- Cleaning** Avoid the use of chemicals, abrasives or solvents. The front panel is best cleaned with a soft brush and a lint-free cloth.
- Dirt, Dust, Smoke and Moisture** Prevent damage to the unit and its cosmetics by avoiding drinks spillage, tobacco ash, smoke, and exposure to rain and condensation. Protect from excessive dirt, dust, heat and vibration.

4 Introduction

Installation

The DR128 fits into a 2U space in a standard 19" rack system. Alternately DR128's rack ears can be removed, and the unit mounted in a cabinet or plinth, or simply used free-standing.

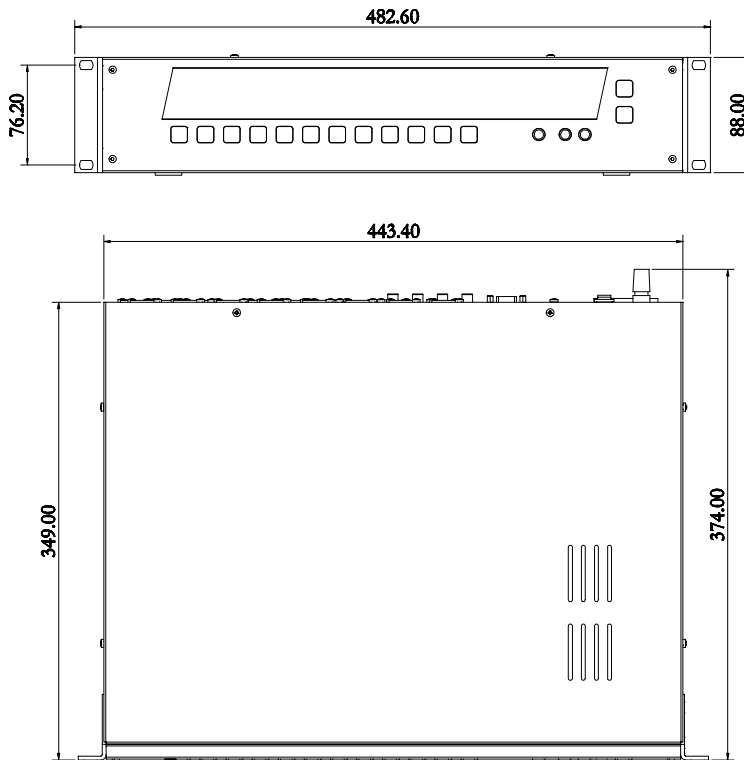

Rack-mount the DR128 using two M6 bolts on each side for maximum strength. These should be provided by the supplier of the rack kit. The rack should allow a minimum side to side opening of 445mm. Provision should be made for removing the top cover for access to the internal configuration links and level trimmers.

Precaution

To avoid damage to the internal assemblies do not fit screws through the sides or underside of the unit. Secure to external brackets or fittings through the front panel rack mounting holes.



Connecting Mains Power

Refer to the Safety Warnings on page 2 and 3 of this User Guide. Check that the voltage on the rear panel is the same as the mains supply in your area. Check that the correct mains lead with moulded mains plug and IEC connector has been supplied with your unit. Read and understand the warnings and instructions printed on the rear panel.

It is advised to turn connected power amplifiers down or off before switching the unit on or off. Ensure that the IEC mains plug is pressed fully into the rear panel socket before switching on.

Changing the Fuse or Mains Voltage Setting

The unit may be configured for the following mains voltages. The rear panel mains protection fuse is a standard 20mm anti-surge type. Use the correct fuse type and rating for the selected mains voltage as shown:

Ac mains	Fuse
100V AC	T1.6A
120V AC	T1.6A
220V AC	T630mA
230V AC	T630mA

To change the mains fuse first remove the mains lead from the rear of the unit. Remove the fuse cover from the AC inlet socket using a flat blade. To change the mains voltage settings replace the fuse cover as indicated on the fuse cover - with the correct mains setting pointing upwards.

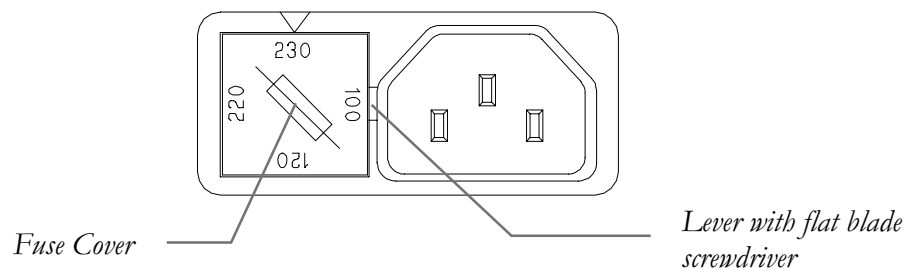

6 Introduction

Connecting DC Supplies

A 24 Volts DC backup supply may be connected so that the unit remains powered in the event of a mains supply failure. This switches in automatically when the mains voltage falls below a certain level.

The DC supply should be connected to the red and black 1/4" terminal plugs on the rear panel.

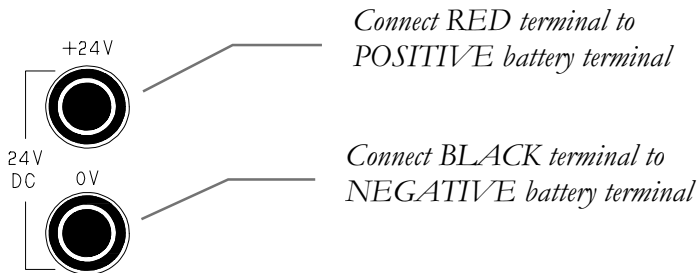

The DC power inputs are protected by an internal fuse in the event of reverse polarity connections. The fuse is a 20mm 5 Amp anti-surge type. Remove the unit's cover to gain access to the DC supply fuse, which is located on the PSU PCB.

Remove all power to the DR128 when replacing the fuse

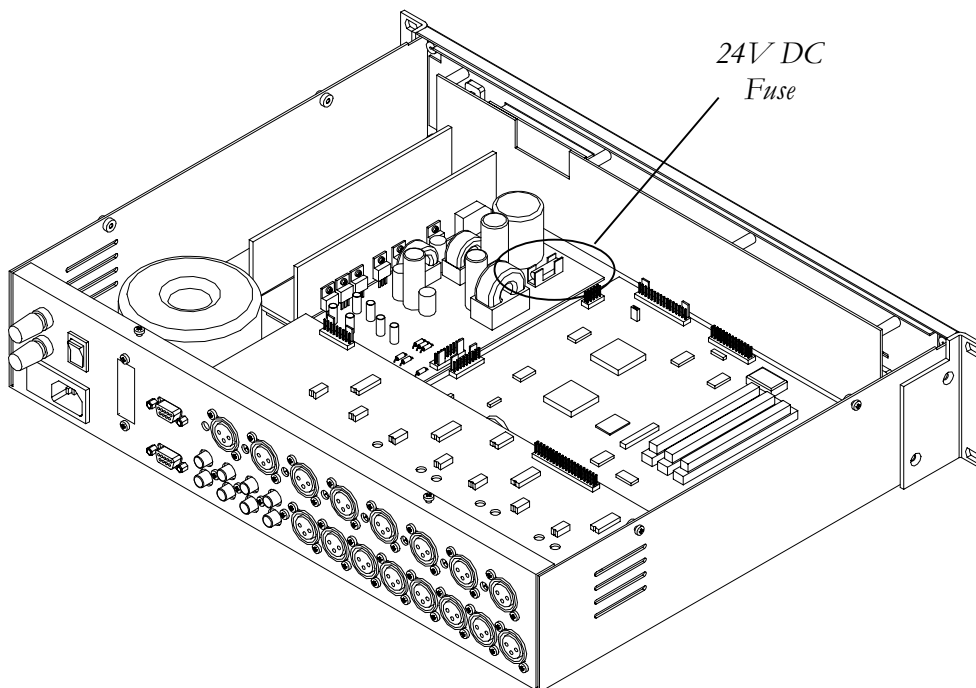

Earthing

The connection to mains earth (ground) in an audio system is important for two reasons:

1. **Safety** - To protect the operator from a high voltage shock associated with the AC mains supply feeding the system.
2. **Audio Performance** - To minimise the effects of ground loops which result in audible hum and buzz, and to shield the audio signals from interference.

For safety it is important that all equipment earths are connected to mains earth so that exposed metal parts are prevented from carrying high voltage which can injure or even kill the operator. It is recommended that the installation engineer check the continuity of the safety earth from all points in the system including microphone bodies, cables and equipment panels.

The same earth is also used to shield audio cables from external interference such as the hum fields associated with power transformers, lighting dimmer buzz, and computer radiation. Problems arise when the signal sees more than one path to mains earth. An earth loop results causing current to flow between the different earth paths. This condition is usually detected as mains frequency audible hum or buzz.

To ensure safe and trouble-free operation we recommend the following:

Do not remove the earth connection from the DR128 mains plug. The chassis of the DR128 is connected to mains earth through the power cable to ensure your safety. Audio 0V is connected to the chassis internally. If problems are encountered with earth loops operate the 'ground lift' switches on connected equipment accordingly, or disconnect the screens from interconnecting audio cables at one end, usually at the destination.

Avoid running audio cables next to mains, computer or lighting cables or near thyristor dimmer and power supply units. If unavoidable, cross the cables at right angles.

Use low impedance sources such as 600 Ω or less microphones to reduce susceptibility to interference. The outputs of the DR128 are designed to operate at very low impedances to minimise interference problems.

Use balanced connections where possible as these provide further immunity by canceling out interference that may be picked up on long cable runs. To connect an unbalanced source to a balanced Mic/Line input link the cold input (XLR pin3) to 0V earth (XLR pin1) at the unit. To connect a balanced Line output to an unbalanced destination link the cold output to 0V earth at the DR128.

Use professional quality cables and connectors and check for correct wiring and reliable solder joints.

8 Introduction

This page is intentionally left blank

DR128 Overview

Introduction.....	10
Main Features.....	10
Signal Processors.....	10
Basic Principles.....	11
Resource Palettes.....	12
Front Panel Layout.....	14
Front Panel	14
1 Removable Front Panel.....	14
2 LCD.....	14
3 Control Keys	14
4 Function Keys.....	14
5 Status LEDs/Signal Meters.....	14
6 Setup Keys	14
7 Rack Ears.....	14
Rear Connector Panel Layout.....	14
Rear Panel	16
1 Battery Input	16
2 Sys-Net Option.....	16
3 RS-232.....	16
4 Mic/Line Inputs.....	16
5 Mains Input	16
6 Remote Input	16
7 Line Inputs.....	16
8 Line Outputs	16

10 DR128 Overview

Introduction

The DR128 is a 12 input, 8 output Digital Audio Mix Processor designed for installed systems. The powerful and expandable internal signal processing enables sophisticated installation setups requiring full matrix mixing, zoning and signal processing in a single 2U space.

Allen & Heath WinDR System Manager, is a Microsoft Windows 95™ application running on a PC. It is provided for setting up the routing, configuration and signal processing of the DR128. Once configured, the DR128 performs as a stand-alone system without the need to run WinDR. The DR128 can be password protected from the front panel to prevent any unauthorised tampering.

Signal Processing capability is also expandable using optional plug-in cards.

Main Features

- 8 Balanced XLR Mic/Line inputs with individual +15V Phantom Power
- 4 Unbalanced L+R mono-summed RCA phono Line inputs
- 8 Balanced XLR outputs
- 8 opto-isolated inputs for remote control
- RS-232 for connection to PC serial port (to run WinDR)

- Fully assignable 12 x 8 Crosspoint Matrix with level control at each point
- 16 Internal configuration patch memories
- 12 assignable front panel Function Keys
- 8 output protection Limiters
- Multiple-Priority Ducker for voice and music override
- Auto-Peak detection on all inputs and outputs
- Phase reverse facility on all inputs and outputs

- Front Panel Setup allows quick setup and trouble-shooting without WinDR
- Password protected tamper proofing
- Real-Time Clock for time of day/date events
- Desktop or 2U 19" rack-mount operation
- Mains and 24V DC operation

Signal Processors

Signal processing is configured using the WinDR application on the PC and provides a combination of the following:

- Graphic EQ 31, 15 and 7 Band
- Parametric EQ 6, 4 and 2 Band
- Noise Gate
- Compressor

Basic Principles

The DR128 performs its signal processing in the digital domain by first converting the analog audio inputs to digital signals using high-quality A to D converters. The digital audio is then passed through a series of Digital Signal Processing Engines before being converted back to analogue audio using high-quality D to A converters. It is the Digital Signal Processing Engines that give the DR128 its power and versatility.

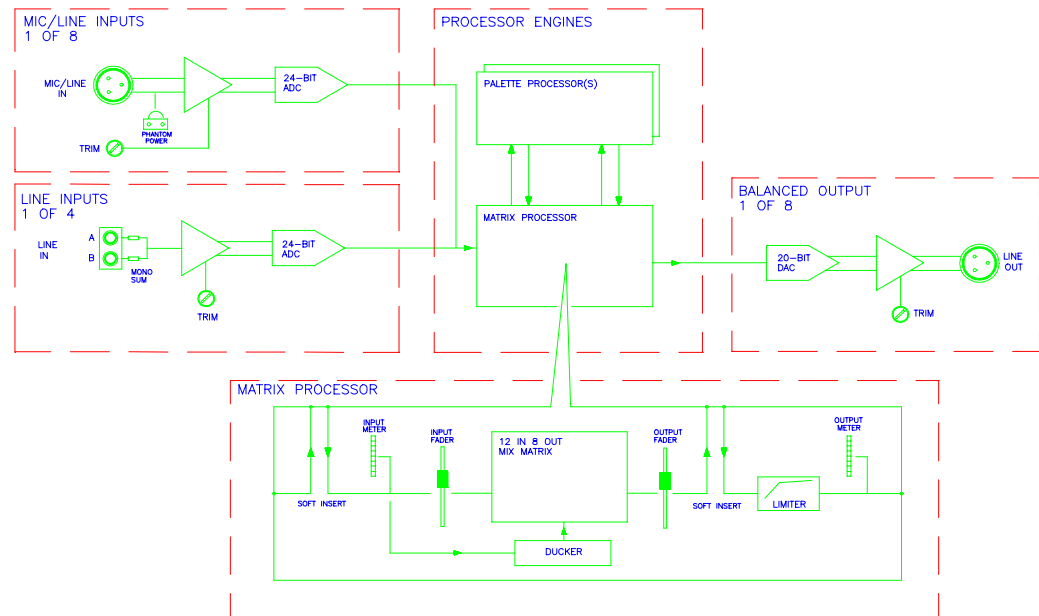

The Basic DR128 contains 2 Digital Signal Processing Engines as standard (PE's for short). The first PE implements the Matrix Processor whose configuration is always fixed. The Matrix Processor provides:

- 12 Input and 8 Output faders
- 12 Input and 8 Output signal meters
- 12 in 8 out crosspoint matrix with variable gain at each crosspoint
- 8 output protection Limiters
- Multiple priority Ducker
- 12 Input and 8 Output soft-insert points for signal processing

All the above functions can be configured either from the DR128's Front Panel using the Setup Menus, or by using WinDR System Manager running on a PC.

The second PE is available for installer-configurable signal processing. Signal Processing resources such as Parametric and Graphic EQs, Gates and Compressors are provided in Resource Palettes and can only be assigned and configured using Allen & Heath WinDR system manager software running on a PC.

12 DR128 Overview

DSPx Expansion Option

Further signal processing capability is made possible by fitting up to 2 DSPx Plug-In Expander cards. Each DSPx contains an additional 2 Processing Engines. Thus up to 6 Processing Engines can be fitted in total with 5 of these available for custom-configured signal processing.

DSPd Delay Option

In addition to the 2 DSPx Expander cards an additional DSPd Delay Option card can be fitted. This provides up to 0.6 seconds (600mS) of signal delay on each output channel.

Resource Palettes

The signal processing is provided in a set of Resource Palettes. Each Resource Palette contains different combinations of audio signal processors such as Graphic or Parametric EQ, compressors, and gates. Each Processing Engine (PE) in the DR128 can be assigned a Resource Palette.

A basic DR128 configuration has 2 PEs, the first PE is always fixed as the Matrix Processor (see above), so 1 of the Resource Palettes can be used. If one DSPx Expander is fitted then there are 3 PEs available for 3 different Resource Palettes. The options are summarised below.

DR128 Configuration	Resource Palettes
Basic DR128	1
Basic DR128 + one DSPx Expander card	3
Basic DR128 + two DSPx Expander cards	5

A list of Resource Palettes is detailed in the Help menu of WinDR system manager software.

Double click on this icon in the WinDR help

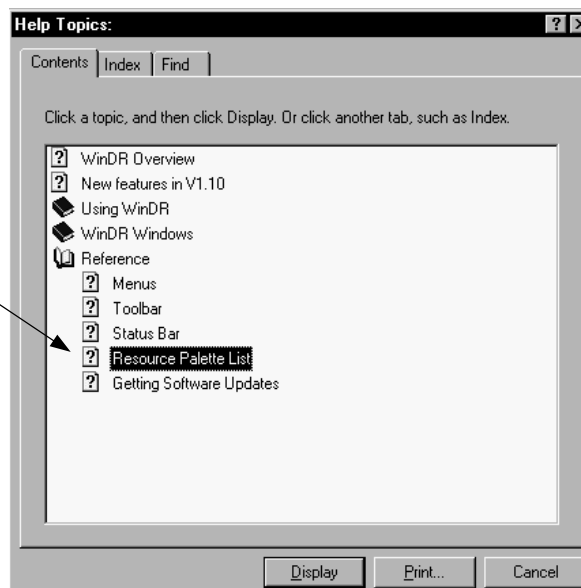

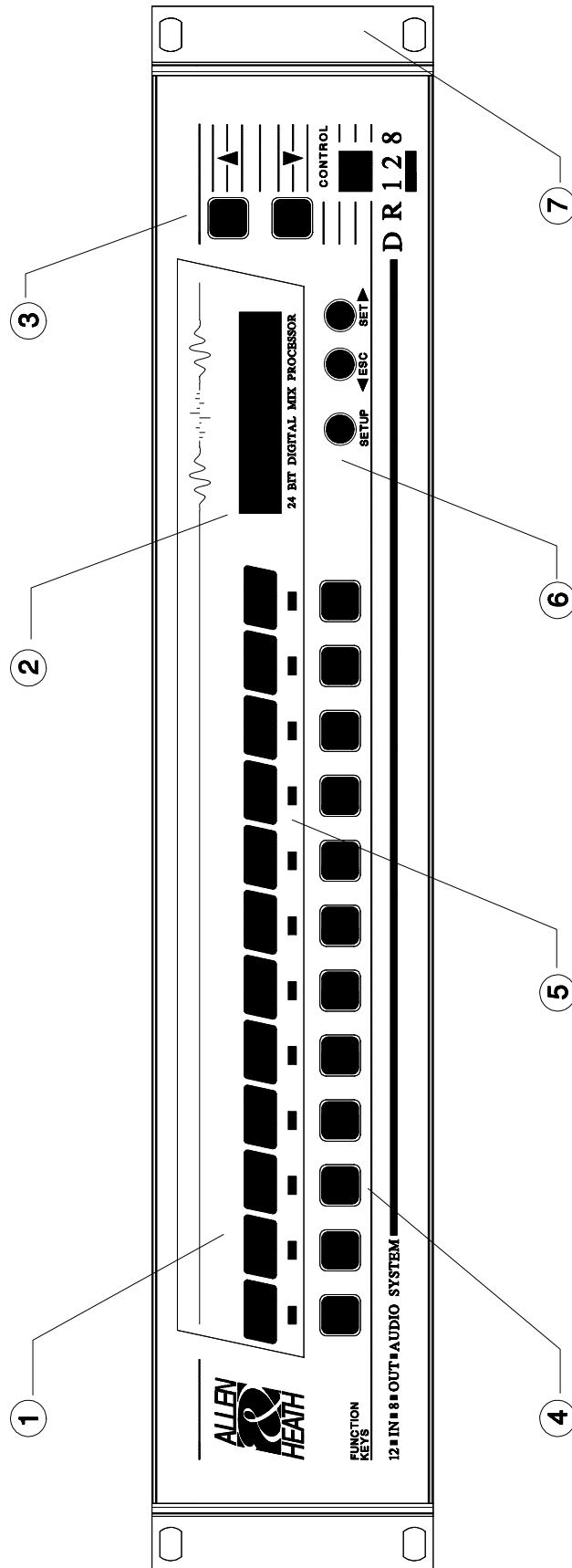

14 DR128 Overview

Front Panel

The DR128's Front Panel is designed to provide both Matrix Processor Setup capabilities for the installer, and a flexible control interface for the user. Because each installation has unique requirements, 12 assignable Function Keys are provided. These keys, in conjunction with the 3-colour LEDs can be assigned as Level controls for input and output channels with trim limits; or Patch Recall to access the 16 internal parameter patches.

1 Removable Front Panel

The Front Panel facia can be removed to allow the installer to fit customised labels for the Function Keys. The labels are protected by the facia when it is refitted. The Front Panel is attached using hex-socket screws for tamper proofing.

2 LCD

A 2x16 character illuminated LCD allows the Matrix Processor to be configured during Setup, and to provide User information during normal use.

3 Control Keys ▲▼

These ▲▼ keys are used to increment/decrement parameters during Setup. They are also used in conjunction with the Function Keys to change levels and Patches during normal operation.

4 Function Keys

12 Function Keys are provided whose function can be assigned during Setup. Each key can be assigned as a Level trim, Patch change, or left unused.

5 Status LEDs/Signal Meters

Each Function Key has an associated 3-colour LED indicator. If the Function Key is assigned as a Volume trim the LED acts as a signal/peak meter (Green/Red). If assigned to an active Patch the LED indicates status (Amber).

6 Setup Keys ◀ ▶

Press and hold the Setup Key to enter Setup Mode. This allows the Matrix Processor to be adjusted without connecting a PC. Access to the Setup Menus can be password protected. The ESC and SET keys are used in conjunction with the ▲▼ control keys to navigate and edit the Setup Menus.

7 Rack Ears

The rack ears can be removed for optional desktop use.

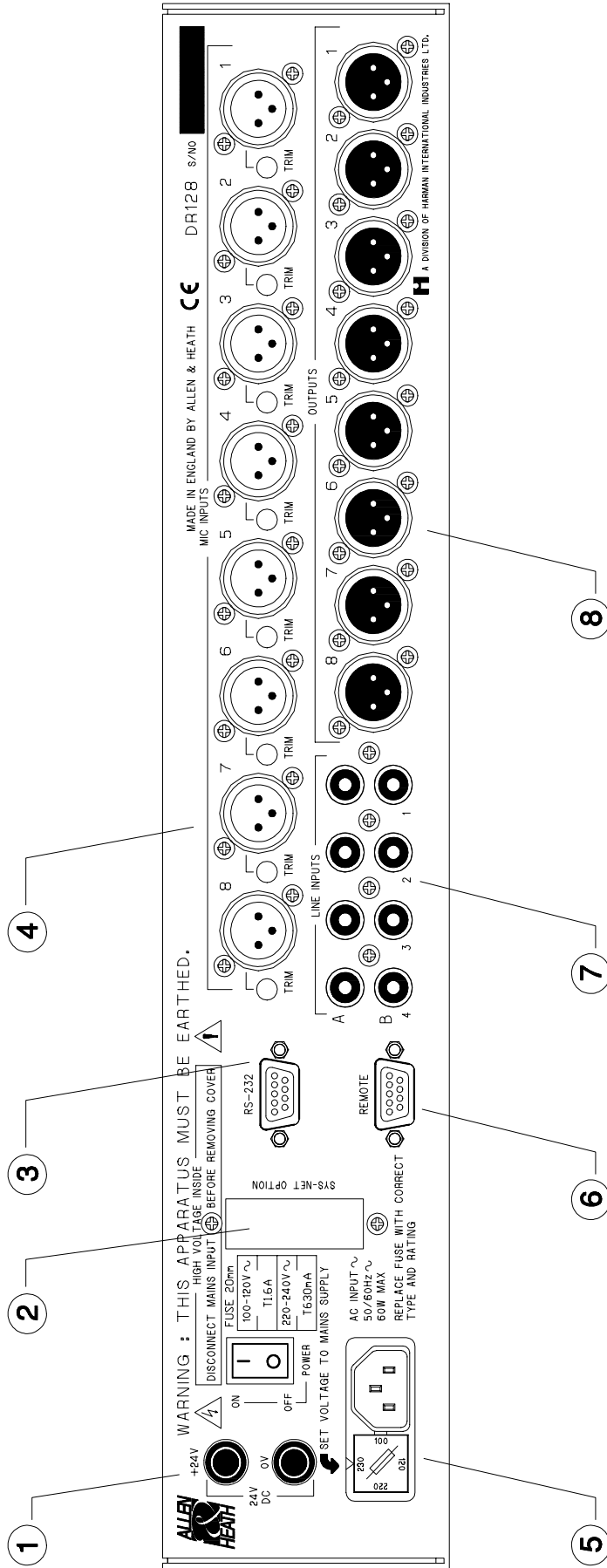

16 DR128 Overview

Rear Panel

1 Battery Input

Standard ¼" terminal inputs are provided for 24V DC battery operation. This allows uninterrupted and full DR128 operation in the event of mains power failure.

2 Sys-Net Option

This slot is provided for future remote control and expansion options.

3 RS-232

9-pin Female D-Type for direct connection to a PC running WinDR System Manager software. A 9-way male to 9-way or 25-way female 'pin-to-pin' cable is required for connection to a PC serial port. We recommend cable lengths no longer than 3m for reliable operation. Do not use a Null-Modem cable.

4 Mic/Line Inputs

8 Balanced Mic/Line inputs are provided on female XLR connectors. Recessed gain trim potentiometers provide 60dB of gain adjustment. Individual Phantom Power (+15V) and 20dB pad options are provided on internal links.

5 Mains Input

Fused IEC Mains socket for the internal power supply.

6 Remote Input

9-Way Female D-Type provides 8 opto-isolated switch closure inputs. The switch functions are software configurable in a similar fashion to the Front Panel Function Keys.

7 Line Inputs

4 unbalanced mono Line inputs are provided on dual RCA Phono connectors. Dual inputs (A+B) are provided for mono summing of stereo inputs. Operating levels from -10dBV to +4dBu can be adjusted using internal trim potentiometers.

8 Line Outputs

8 Balanced Line Outputs are provided on male XLR connectors. Output operating levels from -10dBV to +4dBu are adjustable using internal trim potentiometers.

Using the DR128

Contents

Front Panel Display.....	18
Auto-Peak	18
Patches.....	18
Function Keys	19
Function Key Unused.....	20
Function Key as a Level Control.....	20
Patch Select	22
Patch Recall.....	23
Remote Switches.....	23
Remote Switch Examples	23
Wiring Remote Switches	23

18 Using the DR128

Front Panel Display

When turning on the DR128 the LCD will display the following messages.

DR128 Ver 1.00
Please Wait

The top line provides the firmware version number. This will display for about 10 seconds while the DR128 is initialising. During boot-up all of the output channels are muted. When the initialisation is complete the LCD will display the following.

01 Patch 01
Wednesday 11:59

The top line of the LCD will display the current Patch number and Patch Name. The Patch number will be the last Patch recalled before the DR128 was turned off. The bottom line will display the current Day and Time.

Auto-Peak

Because all of the DR128's inputs and output levels are not always visible on the Front Panel, an Auto-Peak feature will display a warning message on the bottom line of the LCD if input or output levels are **within 4dB of clipping**.

02 Patch 02
Mic 1 : PEAK!

The message will remain displayed until the levels drop below the 4dB threshold. If the peak was caused by a momentary peak, the message will hold for 5 seconds.

If multiple channels are activating Auto-Peak there is a priority for which channels get displayed. Input Channels have priority over Output Channels, and the lower number channels have priority over higher number channels.

Note that Auto-Peak does not operate when in Setup Mode, or when using a Function Key, for example when changing levels or patches.

Patches

There are 16 programmable Patch memories available internally in the DR128. A Patch stores all of the DR128 parameter settings: levels, limiter, ducker etc. If any

DSP Resources have been configured using WinDR these assignments will also be stored in the Patches. To summarise; Patches will store the following settings:

- Input and Output Channel Levels
- Input and Output Channel Phase settings
- Crosspoint Matrix levels
- Limiter settings
- Ducker settings
- DSP Resource assignments and settings

Some DR128 settings apply to the entire unit all of the time and will not be stored in the Patches. Patches will not store the following settings:

- Input & Output Channel Names
- Patch Names
- Function Key assignments
- Remote Key assignments
- Clock and Week-Day settings
- Scheduled Events
- LCD Contrast setting
- Password and Security settings

Patches are set up either using the Save Patch item in Setup Mode, or by using WinDR. Patches can be recalled by any of the following:

- Recall Patch in Setup Mode
- Function Keys assigned as Patch Recall/Patch Select
- Remote Keys configured as Patch Recall
- Recall Patch from WinDR

The factory defaults for all Patches are:

- All Input & Output Channel levels are at 0 (minimum)
- All Crosspoint Matrix levels at 100 (maximum)
- Patch names are 'Patch 01', 'Patch 02', etc.

Function Keys

The 12 Front Panel Function keys are provided to allow the end-user basic control over the DR128's functions. Each Function Key can be assigned the following tasks:

Unused The Function Key has no action

Level Control The Function Key can be used to change the level of an Input or Output Channel. There are various ways of controlling level:

Level Down Pressing the Function Key decreases the level

20 Using the DR128

Level Up/Dn The level can be increased or decreased using the ▲▼ Front Panel keys

In each case Trim Limits can be set up which limit the amount of level range that can be adjusted from the Function Key.

Patch Select The Function Key can be used to select and recall any of the 16 internal Patch memories

Patch Recall The Function Key can be used to directly recall a single Patch

The Function Keys are configured using Setup Mode. See page 46. A description of how to use the Function Keys in each of their configurations is given below.

Function Key Unused

The Function Key has no action. When the function key is pressed the LCD displays the following:

PATCH: Patch 02
Unused

This display will remain while the Function Key is pressed. The Function Key's LED will always remain OFF.

Function Key as a Level Control

A Function Key can be programmed to control the levels of a single Input or Output channel. The simplest case is when a Function Key is configured as a Level Increment or Level Decrement.

Level Increment/Decrement

If the Function Key is assigned as a Level Increment, pressing the Key displays the following:

Mic 1 Lev 65

■ ■ ■ ■ ■ ■ ■ _ _ _ ↑

The top line of the LCD provides the name of the channel whose level is being changed and the current level setting. The level is displayed as a value between 0 and 100. The table below relates these to actual dB values. Each press of the Function Key will increase the level by 5 units. If the key is held down the level will scroll up.

	100	95	90	85	80	75	70	65	60	55	50
dB	0	-1	-2	-3	-4	-5	-6	-7	-9	-11	-13

	45	40	35	30	25	20	15	10	5	0
dB	-15	-18	-21	-25	-30	-35	-40	-50	-60	OFF

The bottom line of the LCD display shows a bar-graph representation of the level. The \uparrow indicates that the level is being increased.

Similarly, if the Function Key is assigned as a Level Decrement, pressing the Key displays the following:

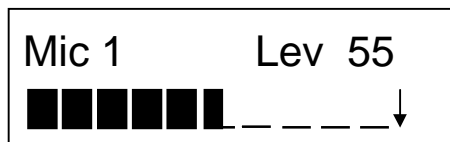

Here the \downarrow indicates that the level is being decreased.

Level Change

If a Function Key has been assigned as Level Change the Function Key selects the channel and the \blacktriangle \blacktriangledown keys are used to change the level. Each press of the \blacktriangle \blacktriangledown keys will increase or decrease the level by 5 units. If the key is held down the level will scroll.

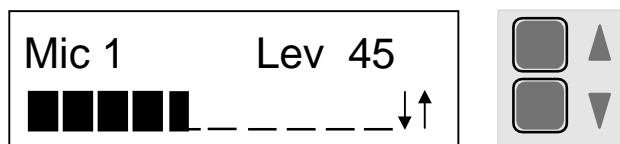

Note that you do not need to keep holding down the Function Key while adjusting the volume. The LCD will revert to its normal display after about 5 seconds if no keys are pressed. You can return to the normal display directly by pressing the ESC key.

Level Trims

In Setup Mode each Function Key assigned as a Level Control can be given Trim Limits which define the minimum and maximum levels that can be obtained using the Function Key. As default the minimum and maximum trim limits are set to 0 and 100 allowing full control over the level range.

When adjusting the level using a Function Key, if the defined maximum or minimum level is reached a bar will appear above the \uparrow or below the \downarrow indicating that the level cannot be increased or decreased any further.

22 Using the DR128

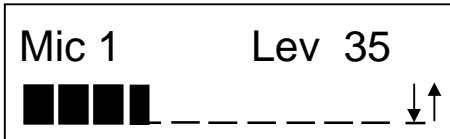

Here the minimum level has been set to 35 (or -21dB).



Here the maximum level has been set to 75 (or -5dB).

Signal Meter

When assigned as a level control the LED indicator above the Function Key will act as a signal meter. Green indicates signal present and Red indicates a signal peak nearing clipping

Green	on at -36 dBFS
Red	on at -6 dBFS

Clipping occurs at 0dBFS which is the maximum internal signal level in the DSP.

Patch Select

A Function Key can be programmed to allow the User to select and recall one of the 16 internal Patch memories. Pressing the Function Key will display the following:

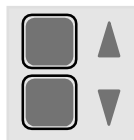
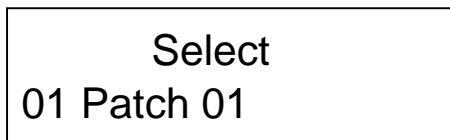

Use the ▲▼ keys to scroll through the 16 Patches.

The bottom line of the LCD shows the Patch number and the Patch Name.

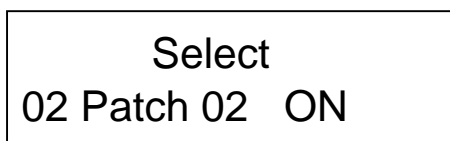

If the displayed Patch number is currently active, ON will be displayed.

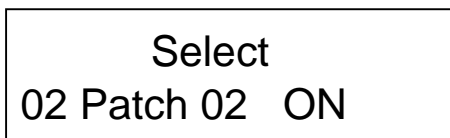

When the desired Patch is displayed, press SET to recall it.

To cancel the Patch Select operation at any time press ESC. If during Patch Select no keys are pressed the display will revert to normal after about 5 seconds.

Status Indicator

When a Function Key is assigned as a Patch Recall the Key's LED will act as a status indicator. If the Patch is the current Patch the LED will turn on Amber.

Patch Recall

A Function Key can be programmed to directly recall one of the 16 internal Patch memories. For example if a Function Key was configured to recall Patch 1, pressing the Function Key will display the following:

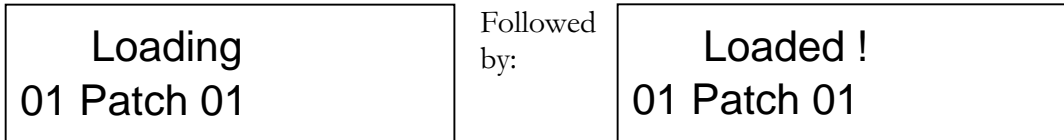

After which the LCD will revert to normal.

Remote Switches

A 9-way female D-Type connector is provided on the DR128's Rear Panel for connecting up to 8 remote momentary action switches. Remote switches can be configured in a similar fashion to the Front Panel Function Keys to perform the following tasks:

- Input or Output Channel Level Increment
- Input or Output Channel Level Decrement
- Patch Recall

Remote Switch Examples

Fitting 2 momentary switches on a remote panel could therefore allow level control for an input or output by programming the switches as Level Increase and Decrease functions.

For Alarm applications, a Switch Input could be configured as a Patch Recall and connected to an installation's Alarm System. The Patch associated with the Switch could be configured to turn off all background music and route an emergency evacuation message to all the output zones.

Refer to Page 48 for details on configuring the Remote Switches.

Wiring Remote Switches

The pin-out of the connector is shown below (view into the rear panel connector):

Pin 1 - Switch 1 Input
Pin 2 - Switch 2 Input
Pin 3 - Switch 3 Input
Pin 4 - Switch 4 Input
Pin 5 - Switch 5 Input

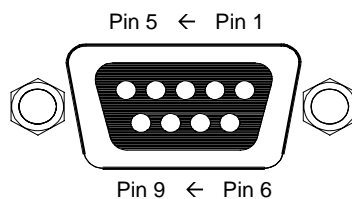

Pin 6 - Switch 6 Input
Pin 7 - Switch 7 Input
Pin 8 - Switch 8 Input
Pin 9 - Common

24 Using the DR128

Note that the shell of the D-Type connector should be connected to the cable shield. Wire up the switches so that the switch contacts will short the Switch Input line (pins 1 to 8) to the Common line (pin 9). Up to 1000m of shielded cable can be connected to each switch input.

The example below shows how 2 switches can be connected to the DR128 to control the level of an Input or Output Channel. For example Remote Switch 1 would be configured as Output Level Increase on Output Channel 1, and Remote Switch 2 as Output Level Decrease on Output Channel 1.

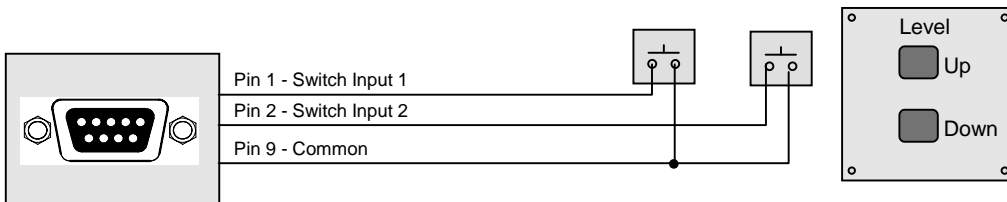

To control a stereo source, 2-pole momentary switches can be used as shown below. For example, a stereo source connected to inputs 9 and 10 can simultaneously be remotely controlled using two 2-pole switches.

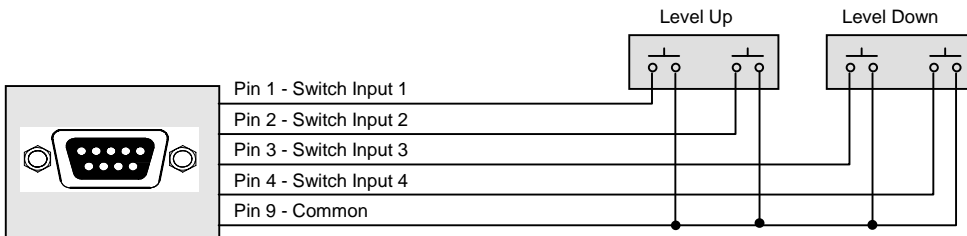

- Switch Input 1 configured as Level Increase on Input Channel 9
- Switch Input 2 configured as Level Increase on Input Channel 10
- Switch Input 3 configured as Level Decrease on Input Channel 9
- Switch Input 4 configured as Level Decrease on Input Channel 10

Remote switches can also be connected in parallel to provide, for example, remote control of a level from more than one location.

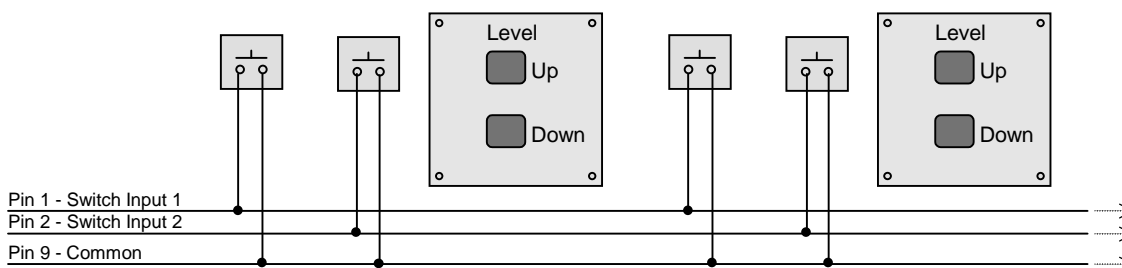

4

Hardware Configuration

Signal Levels 26

Mic/Line Inputs..... 27

 Setting Mic/Line Input Gain..... 27

 Selecting Mic Pad 28

 Phantom Power 28

Line Inputs..... 29

 Setting Line Input Gain..... 29

Balanced Outputs..... 31

 Setting Output Gain..... 31

26 Hardware Configuration

Configuration of the following settings are detailed in this chapter:

Setting	Adjustment Made	Factory Setting	Notes
Mic Input Gain	On rear panel	Gain minimum	Fully anti-clockwise
Mic/Line Pad	Links on Mic In PCB	Pad not enabled	Links fitted
Mic Phantom Power	Links on Mic In PCB	Phantom Power On	Links fitted
Line In Sensitivity	Internal trimmer on Line Out PCB	-10dBV sensitivity	Trimmer fully clockwise
Output Sensitivity	Internal trimmer on Line Out PCB	+4dBu sensitivity	Trimmer fully anti-clockwise

Some of the DR128s settings are accessed internally and require the top cover to be removed by removing the screws.

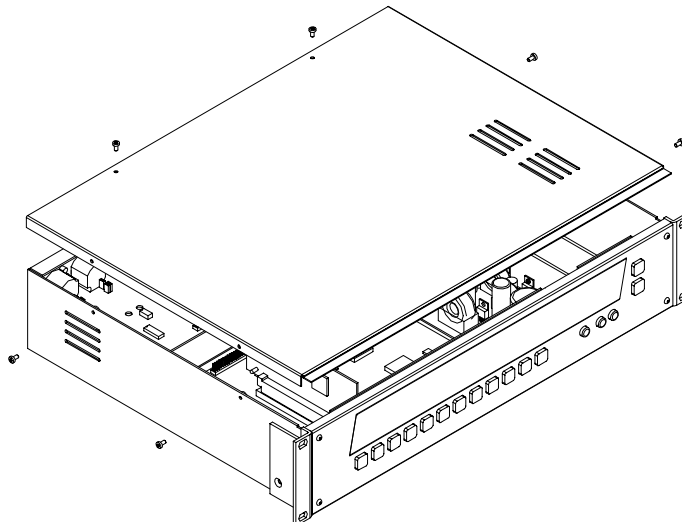

Signal Levels

When configuring signal levels it is advised to have WinDR connected to make use of the full-range Input and Output meters. Alternately, the front panel function keys can be programmed as Input or Output levels controls - the front panel LEDs will then act as signal meters.

Green	on at -36 dBFS
Red	on at -6 dBFS

Clipping occurs at 0dBFS which is the maximum internal signal level in the DSP.

The Auto-Peak feature will also warn you when an input or output signal is at 4dB below clipping.

Mic/Line Inputs

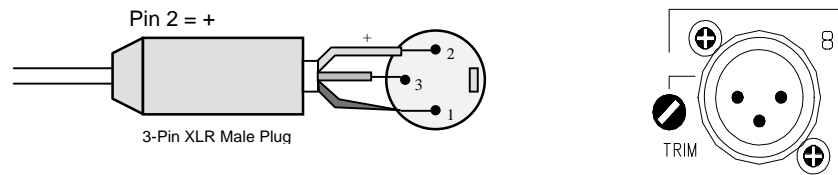

8 Mic/Line inputs are provided with an external recessed gain trimmer and internal links for 22dB Pad and +15V Phantom Power. Both Microphone and Line sources such as sub-mixer outputs, and processors can be plugged into the XLR inputs.

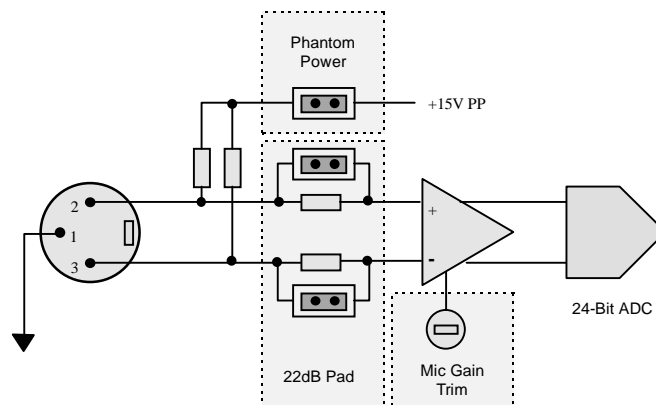

The input accepts a wide 64dB range of source levels (42dB gain trim plus 22dB Pad). The input is balanced to provide the best immunity to interference pickup on long cable runs. You can plug in an unbalanced 2-wire source simply by linking the input -ve (cold) connection to ground (XLR pin 3 to pin 1) in the connector plug.

Setting Mic/Line Input Gain

Each of 8 XLR Mic/Line inputs has a recessed gain control potentiometer accessed from the rear panel. To adjust the gain use a small flat headed screwdriver into the slot of the potentiometer spindle. Gain is increased by turning the potentiometer clockwise when looking at the rear panel. The Gains are factory set at minimum gain. The gain values are shown below for different gain trim positions. Line settings are with the 22dB Pad inserted (Pad links removed).

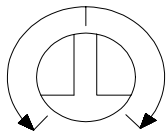
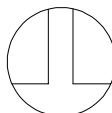
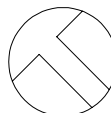
	 Anti-Clockwise	 Mid	 Clockwise
Mic Gain (dB)	18	35	60
Line Gain (dB)	-4	13	38

28 Hardware Configuration

Selecting Mic Pad

The Mic/Line inputs of the DR128 are factory configured as Mic Inputs. To use the inputs as Line level inputs remove the two internal links fitted in each input stage. Removing the links adds 22dB of **attenuation**.

Remove the top cover to access the links. These are located on the top Mic/Line PCB. The locations for each channel are shown below:

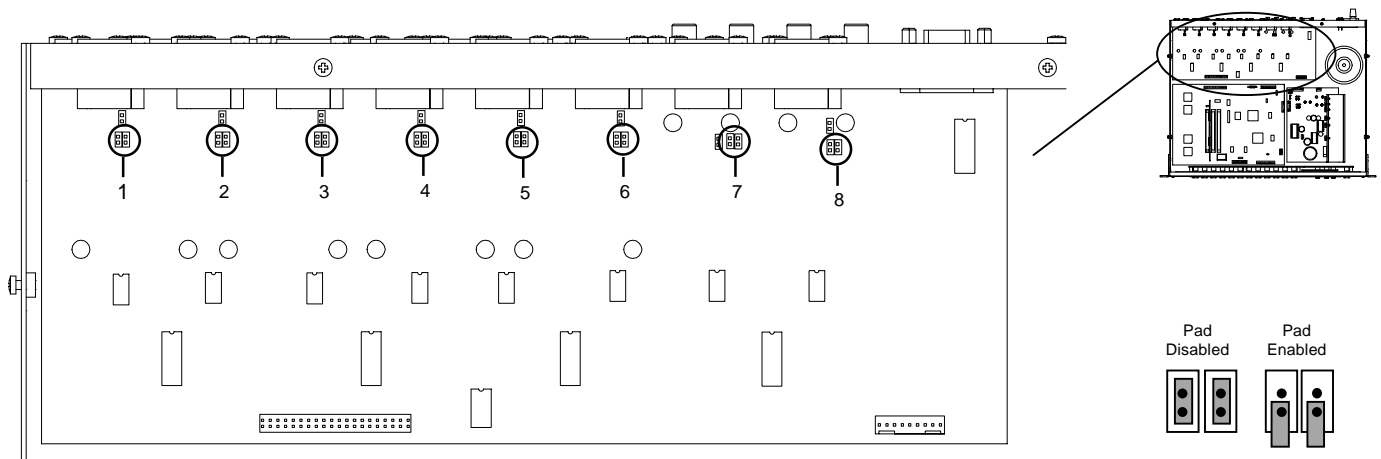

Precaution

Make sure that the Phantom Power is disconnected when using the Mic/Line inputs with Line level sources.

Phantom Power

The DR128's Mic/Line inputs are factory configured as Mic Inputs with Phantom Power ON. The +15V Phantom Power voltage fed to pins 2 & 3 of the XLR socket is sufficient for powering most condenser type microphones. Ensure that balanced leads are used when using Phantom Power. Note that non-powered dynamic type microphones can be phantom powered without damage.

Each Mic Input has a link to enable or disable Phantom Power. To disable Phantom Power remove the jumper links. Remove the top cover to gain access to the Phantom Power links. These are located on the top Mic/Line PCB. The locations for each channel are shown below:

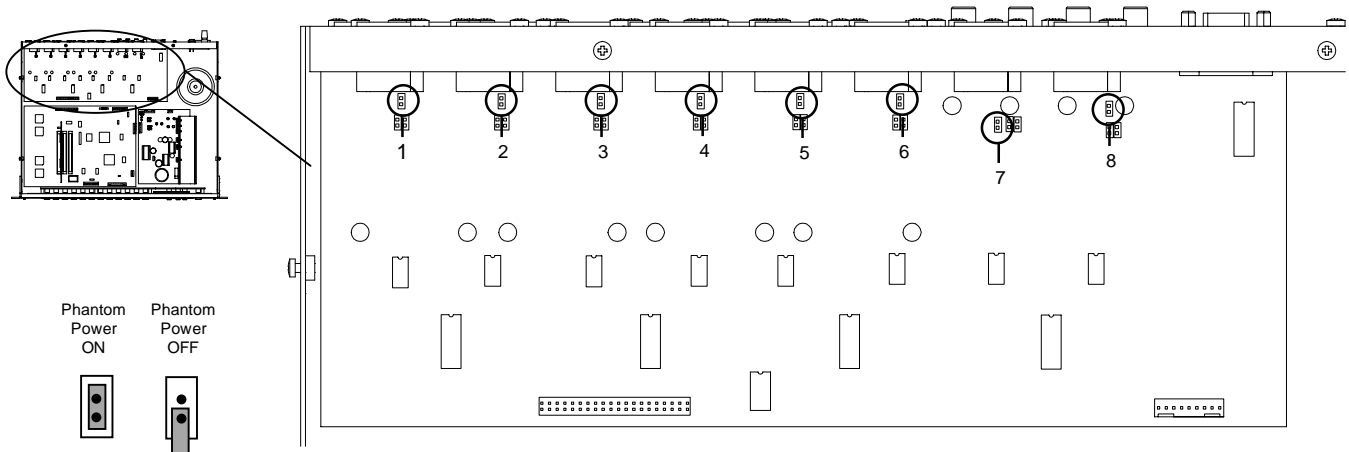

Line Inputs

Four unbalanced Line inputs are provided on RCA Phono type connectors with an internal gain trimmer.

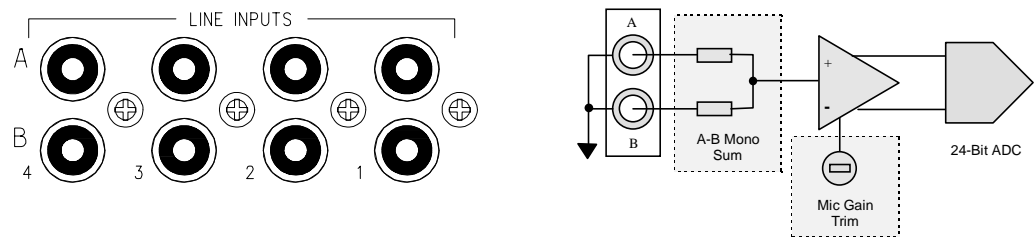

Line sources such as CD Players, Tape Machines and Satellite Receivers, can be plugged into the Line inputs. Each of the 4 Line inputs provides two connectors, A & B, which allow a stereo source to be summed to mono at the input. For stereo operation multiple Line input channels must be used. Thus up to 2 stereo unbalanced Line inputs can be accommodated. The input is unbalanced 2-wire.

Setting Line Input Gain

Each of 4 Phono Line inputs has an internal gain trim potentiometer with a 12dB gain range. This allows the input sensitivity to be adjusted between domestic low level -10dBV signal sources and professional high level +4dBu sources. The DR128 is factory configured for -10dBV signal sources which is suitable for most domestic line level sources from CD Players, Tape Machines, and Satellite Receivers. However, certain equipment with higher output levels can be accommodated by setting the input gain to accept +4dBu nominal input levels.

The gain trimmers are located on the circuit board below the Mic/Line input circuit board and are accessed by inserting a small cross headed screwdriver through the holes provided in the Mic/Line Input circuit board.

30 Hardware Configuration

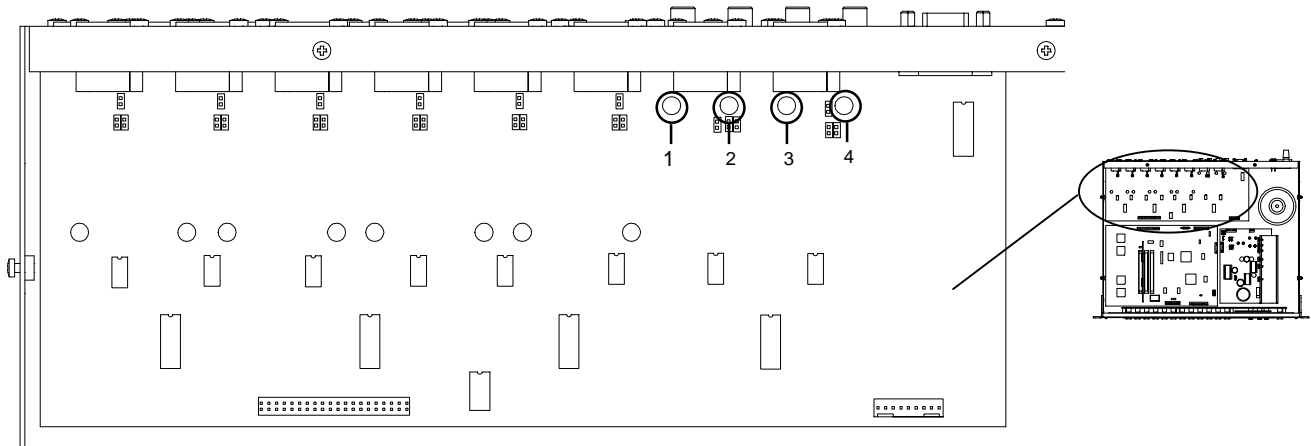

To decrease the input sensitivity carefully insert the screwdriver through the hole in the Mic Line PCB, locate the tip of the screwdriver in the gain trimmer and rotate gently anti-clockwise. Do not use excessive force.

Caution

Do not attempt to force the gain trimmers as they can easily be damaged.

The sensitivity is factory set at -10dBV (or approximately -8dBu, maximum gain). The gain/sensitivity values are shown below for different trimmer positions.

The diagram shows a circular gain trimmer with a cross-shaped center. Arrows indicate the direction of rotation: anti-clockwise, mid (center), and clockwise. Below the diagram is a table showing the corresponding sensitivity and gain values for each position.

	Anti-Clockwise	Mid	Clockwise
Sensitivity (dBu)	+4	-4	-8
Gain (dB)	0	+8	+12

Balanced Outputs

The 8 output channels are provided on balanced line level 3-pin XLR male connectors. The output level is variable using an internal trim potentiometer.

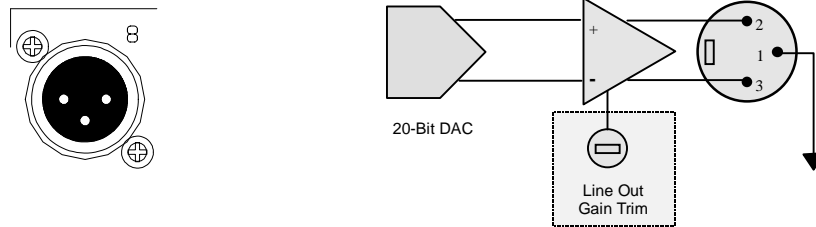

Setting Output Gain

Each of the 8 balanced outputs has an internal gain trim potentiometer with a 12 dB gain range. This allows the output sensitivity to be adjusted between domestic low level -10dBV signal levels & professional high level +4dBu signal levels. The DR128 is factory configured for +4dBu sensitivity which is suitable for connection to most professional power and distribution amplifiers, mixing consoles and signal processing devices. However, certain equipment requiring lower signal levels, such as tape recorders or mixing console inserts, can be accommodated by reducing the output level down to a -10dBV nominal level.

The gain trimmers are located on the circuit board below the Mic/Line input circuit board and are accessed by inserting a small cross headed screwdriver inserted through the holes provided in the Mic/Line Input circuit board.

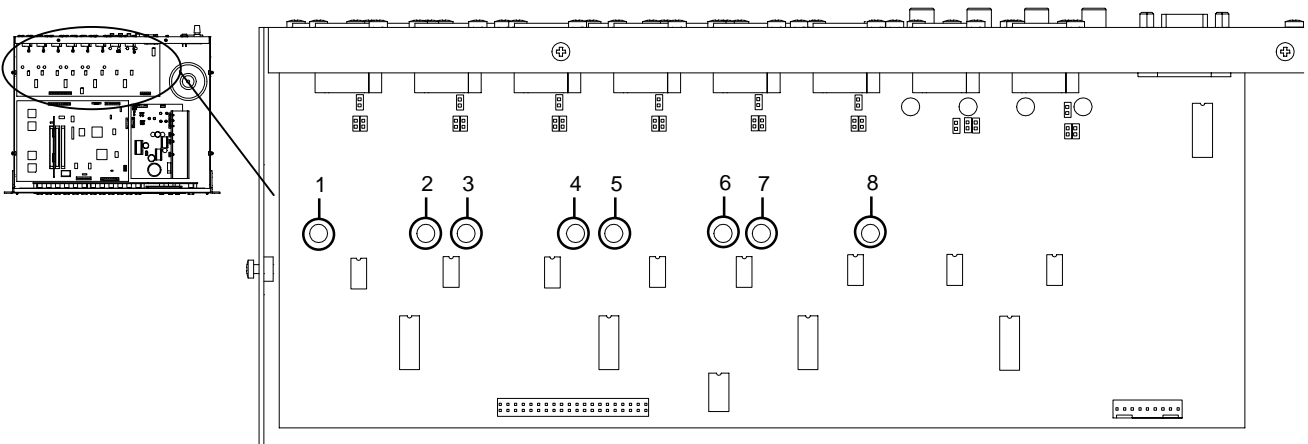

32 Hardware Configuration

To decrease the output sensitivity carefully insert the screwdriver through the hole in the Mic/Line PCB and locate the tip of the screwdriver in the gain trimmer and rotate gently clockwise. Do not use excessive force.

Caution

Do not attempt to force the gain trimmers as they can easily be damaged.

The sensitivity is factory set at +4dBu. The gain/sensitivity values are shown below for different trimmer positions.

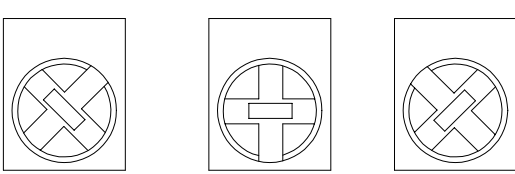
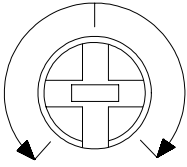

	Anti-Clockwise	Mid	Clockwise
Sensitivity (dBu)	+4	-4	-8
Gain (dB)	0	+8	+12

Setup Menu

Introduction.....	34
Entering Setup Mode.....	34
Entering the Security Password	34
Navigating the Menus.....	35
Exiting Setup Mode	35
Menu Map	36
1 - Recall Patch.....	37
2 - Save Patch	37
3 - Name Patch.....	38
4 - Name Input Channel.....	38
5 - Name Output Channel.....	39
6 - Limiter Setup	40
7 - Ducker Setup	41
8 - Input Phase	43
9 - Output Phase.....	43
10 - Input Level.....	44
11 - Output Level.....	45
12 - Crosspoint Matrix Levels.....	45
13 - Function Key Setup.....	46
14 - Remote Key Setup.....	48
15 - Day of the Week	50
16 - Clock.....	50
17 - LCD Contrast.....	50
18 - New Password.....	51
19 - Security	51

34 Setup Menu

Introduction

The Front Panel Setup Menu provides the installer with an immediate on-site tool for configuring or trouble-shooting the DR128's basic functions. Access to the Setup Mode can be password protected for tamper-proofing.

The Setup Menu provides access to the following functions:

- Recall and Save Patches
- Name Patches, Input and Output channels
- Limiters
- Ducker
- Input and Output Levels and Phase
- Crosspoint Mix-Matrix
- Function & Remote Key assign
- Day & Time Clock setup
- LCD Contrast
- Password and Security Access

Note that you cannot edit any of the DSP Resource Palettes, these can only be changed using WinDR running on a PC connected via an RS-232 cable.

Entering Setup Mode



To enter Setup Mode, press and hold the Setup Key for 2 seconds. If the security feature is enabled a 4 character password is required to access the menu system.

Entering the Security Password

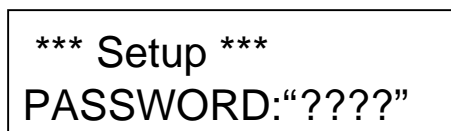

Use the ▲▼ keys to select the first password character, then press SET to move on to the next character, and so forth until the last password character is selected, then press SET.

If the password is incorrect the LCD will display the following and return to normal mode.



If the password is correct the first Menu Item will be displayed.



Navigating the Menus

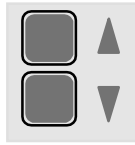

Use the ▲▼ keys on the right hand side of the LCD to navigate through the Main Menu Items.



Use the SET key to edit the settings of a Main Menu item. Use ESC to backtrack or undo any changes made with SET.



When editing Main Menu settings the ▲▼ keys are used to change parameter values and the SET/ESC keys are used to confirm or cancel.

Refer to the Menu Map on page 36 for the Menu structure.

Exiting Setup Mode

To exit Setup Mode press the ESC key. If you have made any changes that can be stored in a Patch you will be prompted to save them in a Patch.



Select YES or NO using the ▲▼ keys then press SET to accept your choice. If you select YES you will be prompted for a Patch Number to store the changed settings.

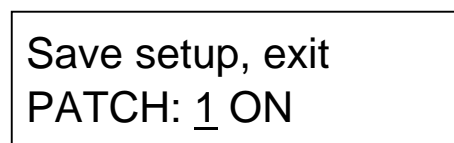

Use the ▲▼ keys to select a Patch. The currently active Patch number will be indicated with ON as shown above. Press SET to save the settings



If you selected NO when prompted to save the patches your new settings will remain until a new Patch is recalled or until the DR128 turned off. The settings will then be lost.

36 Setup Menu

Menu Map

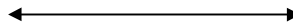

Main Menu Items	Menu Settings
------------------------	----------------------

19 Set Security	[Password]	[On/ Off]
------------------------	------------	-----------

18 New Password	[Current Password]	[New Password]
------------------------	---------------------	----------------

17 LCD Contrast	Contrast [0..10]
------------------------	---------------------

16 Clock	Time [HH:MM:SS]
-----------------	--------------------

15 Day of Week	[Day]
-----------------------	-------

14 Remote Keys	Key Number	<i>Function</i>	<i>Param 1</i>	<i>Param 2</i>	<i>Param 3</i>
	[1..8]	- Unused - Level Control - Patch Change	Channel Patch No.	Min Trim	Max Trim

13 Soft Keys	Key Number	<i>Function</i>	<i>Param 1</i>	<i>Param 2</i>	<i>Param 3</i>
	[1..12]	- Unused - Level Change - Patch Change - Patch Select	Channel Patch No.	Min Trim	Max Trim

12 Matrix	I/P Channel [1..12]	O/P Channel [1..8]	Level [0..100]
------------------	------------------------	-----------------------	-------------------

11 O/P Level	O/P Channel [1..8]	Level [0..100]
---------------------	-----------------------	-------------------

10 I/P Level	I/P Channel [1..12]	Level [0..100]
---------------------	------------------------	-------------------

9 O/P Phase	O/P Channel [1..8]	Phase [NORM/REV]
--------------------	-----------------------	---------------------

8 I/P Phase	I/P Channel [1..12]	Phase [NORM/REV]
--------------------	------------------------	---------------------

7 Ducker	I/P Channel [1..12]	[OFF/ACTIVE]	Priority [1..3]	Threshold [0dB..-60dB]	Depth [1dB..60dB]	Release [1db/s.. 100dB/s]	O/P 1..8 [On/Off]
-----------------	------------------------	--------------	--------------------	---------------------------	----------------------	------------------------------	----------------------

6 Limiter	O/P Channel [1..8]	Threshold [-1dB..-30dBFS]	Response [Slow, Med, Fast]
------------------	-----------------------	------------------------------	-------------------------------

5 Name Output	[Output Name]
----------------------	---------------

4 Name Input	[Input Name]
---------------------	--------------

3 Name Patch	[Patch Name]
---------------------	--------------

2 Save Patch	[Patch Number]
---------------------	----------------

1 Recall Patch	[Patch Number]
-----------------------	----------------



1 - Recall Patch

This menu item is used to recall one of the 16 patches.

*** Setup ***
*1 Recall Patch



Press SET to select the Patch.

*1 Recall Patch
PATCH: 1



Select the Patch number, from 1 to 16.

*1 Recall Patch
PATCH: 2 ON



ON will be shown if the Patch is already active. Press SET to recall the patch.

*1 Recall Patch
LOADING PATCH 2

*1 Recall Patch
PATCH 2 LOADED!

*** Setup ***
*1 Recall Patch

2 - Save Patch

This menu item is used to save the current DR128 settings into one of the 16 patches.

*** Setup ***
*2 Save Patch



Press SET to select the Patch.

*2 Save Patch
PATCH: 1



Select the Patch number, from 1 to 16.

*2 Save Patch
PATCH: 2 ON



ON will be shown if the Patch is already active. Press SET to save the patch. This will take a few seconds

38 Setup Menu

*2 Save Patch
SAVING PATCH 2

*2 Save Patch
PATCH 2 SAVED!

*** Setup ***
*2 Save Patch

3 - Name Patch

This menu item is used to give one of the 16 Patches a name up to 8 characters in length. The Patch Name and its number is displayed on the top line of the LCD during normal operation. The default Patch names are 'Patch 01', 'Patch 02' etc.

*** Setup ***
*3 Name Patch



Press SET to select the Patch.

*3 Name Patch
PATCH: 1



Select the Patch number, from 1 to 16.

*3 Name Patch
PATCH: 2 ON



ON will be shown if the Patch is active. Press SET to name the patch.





*3 Name Patch 2
NAME: "Patch 02"



Use the ▲▼ keys to scroll to the desired character, then press SET to move on to the next character. You can press ESC to move to the previous character. When all characters are done press SET.

4 - Name Input Channel





This menu item is used to give each of the 12 Input Channels a name up to 8 characters in length. If a function key has been assigned to control an Input Channel level, the Input Channel Name is displayed on the top line of the LCD when adjusting the level. The name is also displayed on the channels in WinDR. The default channel names are 'Mic 1', 'Mic 2', 'Line 9' etc.

<p>*** Setup *** *4 Name Input</p>		<p>Press SET to select the Input Channel.</p>
<p>*4 Name Input I/P CHANNEL: <u>1</u></p>		<p>Select the Input Channel number, from 1 to 12. Press SET to enter a name.</p>
<p>*4 Name Input 1 NAME: "<u>M</u>ic 1 "</p>		

Use the ▲▼ keys to scroll to the desired character, then press SET to move on to the next character. You can press ESC to move to the previous character. When all characters are done press SET.

5 - Name Output Channel

This menu item is used to give each of the 8 Output Channels a name up to 8 characters in length. If a function key has been assigned to control an Output Channel level, the Output Channel Name is displayed on the top line of the LCD when adjusting the level. The name is also displayed on the channels in WinDR. The default channel names are 'O/P 1', 'O/P 2' etc.

<p>*** Setup *** *5 Name Output</p>		<p>Press SET to select the Output Channel.</p>
<p>*5 Name Output O/P CHANNEL: <u>1</u></p>		<p>Select the Output Channel number, from 1 to 8. Press SET to enter a name.</p>
<p>*5 Name Output 1 NAME: "<u>O</u>/P 1 "</p>		

Use the ▲▼ keys to scroll to the desired character, then press SET to move on to the next character. You can press ESC to move to the previous character. When all characters are done press SET.

40 Setup Menu

6 - Limiter Setup

Eight Protection Limiters are provided as standard, one on each of the Output Channels. Threshold and Response controls are provided with several settings to alter the performance of the limiters.

Threshold

Threshold parameter determines the level at which the limiter starts operating. Threshold values are given in dBFS. The value can be selected from:

0dB	-1dB	-2dB	-3dB	-5dB	-7dB
-----	------	------	------	------	------

-10dB	-12dB	-15dB	-20dB	-25dB	-30dB	-35dB
-------	-------	-------	-------	-------	-------	-------

When the Threshold is set to 0dB the Limiter is disabled & will have no effect.

Response

The Limiter Response parameters determine how fast the Limiter will react when the audio level is above the Limiter Threshold and how fast the limiter will release when the audio level falls below the threshold.

Attack	100uS	300uS	1mS	3mS	10mS	30mS	100mS	300mS	1S
--------	-------	-------	-----	-----	------	------	-------	-------	----

Release	300uS	1mS	3mS	10mS	30mS	100mS	300mS	1S	3S
---------	-------	-----	-----	------	------	-------	-------	----	----

*** Setup ***
*6 Limiter



Press SET to select the Output Channel.

*6 Limiter
O/P CHANNEL: 1



Use the ▲▼ keys to select the Output Channel. Then Press SET.

*6 Limiter O/P 1
ACTIVE: OFF







Use the ▲▼ keys to toggle the Limiter ON/OFF. Then Press SET.

*6 Limiter O/P 1
THRESHOLD: 0dB

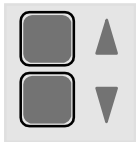

Use the ▲▼ keys to select the Threshold level. Then Press SET.

<div style="border: 1px solid black; padding: 5px;"> <p>*6 Limiter O/P 1 ATTACK: 100uS</p> </div>			<p>Use the ▲▼ keys to select the Attack Time. Then Press SET.</p>
<div style="border: 1px solid black; padding: 5px;"> <p>*6 Limiter O/P 1 RELEASE: 300uS</p> </div>			<p>Use the ▲▼ keys to select the Release Time. Then Press SET.</p>

7 - Ducker Setup

A Multiple-Priority Ducker is provided for each input channel. The Ducker will attenuate Input Channel levels to selected Output Channels when signals are detected on Priority Inputs. Three Priority levels are provided. Input controls are provided for Priority, Threshold, Depth and Release/Hold.

Ducker Priority

First select the Input Channel that will be used to duck other inputs. Each Ducking Input can be assigned one of three priorities

- 1 maximum priority
- 2
- 3 minimum priority

A priority 1 input can duck a lower priority input, etc.

Ducker Threshold

The Ducker Threshold determines the level required on a Priority Input to duck other inputs. The Threshold values are given in dB FS. The value can be selected from 0dB to -60dB in 3dB steps.

Ducker Depth

The Ducker Depth parameter determines the amount of attenuation applied to lower priority inputs when the Ducker is active on the selected channel. Values are given in dB attenuation. For example, a Depth of -6dB will attenuate all affected outputs by 6dB when the Ducker is active. The Depth can be selected from 0dB to -60dB in steps of 1dB.

Ducker Release

The Ducker Release parameter determines the rate at which the ducked input channels will return to their normal levels after the level on the Priority Input has returned below the Threshold. Values are given in dB per second from 1dB per second (slow release) to 100dB per second (fast release) in steps of 1dB per second.

42 Setup Menu

Ducker Output

For each Priority Input, select which output channels are to be affected by the Ducker.

*** Setup ***
*7 Ducker



Press SET to select the Input Channel.

*7 Ducker
I/P CHANNEL: 1

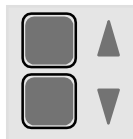

Use the ▲▼ keys to select the Input Channel to activate the Ducker. Then press SET.

*7 Ducker I/P 1
DUCKER: OFF



Use the ▲▼ keys to enable and disable the Ducker.

Select Ducker ACTIVE to configure the other parameters. Ducker OFF is provided for A/B checking & trouble-shooting. If the Ducker is OFF no further menu items are accessible.

*7 Ducker I/P 1
DUCKER: ACTIVE



Press SET to activate the Ducker & edit the Ducker parameters.

*7 Ducker I/P 1
PRIORITY: 1 Max



Use the ▲▼ keys to select the priority and press SET.

*7 Ducker I/P 1
THRESHOLD: 0dB



Use the ▲▼ keys to select the Ducker Threshold and press SET.

*7 Ducker I/P 1
DEPTH: -1dB

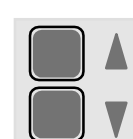

Use the ▲▼ keys to select the Ducker Depth and press SET.

*7 Ducker I/P 1
RELEASE: 1dB/s

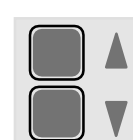

Use the ▲▼ keys to select the Ducker Release and press SET.

*7 Ducker I/P 1
DUCK O/P 1: YES



Use the ▲▼ keys to turn the Ducker ON or OFF on Output Channel 1. Press SET to select Output Channels 2 through 8.



*7 Ducker I/P 1
DUCK O/P 8: NO



8 - Input Phase

This menu item is used to change the phase polarity of each Input Channel. The default settings are for normal (non-inverted) phase.

*** Setup ***
*8 I/P Phase



Press SET to select the Input Channel.

*8 I/P Phase
I/P CHANNEL: 1

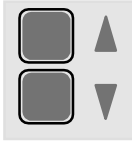

Use the ▲▼ keys to select the Input Channel then press SET.

*8 I/P 1 Phase
PHASE: NORMAL

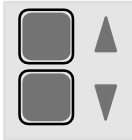

Use the ▲▼ keys to select either NORMAL (non-inverted) or REVERSE (inverted) Phase. Press SET to return to the main menu.

9 - Output Phase

This menu item is used to change the phase polarity of each Output Channel. The default settings are for normal (non-inverted) phase.

*** Setup ***
*9 O/P Phase



Press SET to select the Output Channel.

*9 O/P Phase
O/P CHANNEL: 1

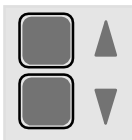

Use the ▲▼ keys to select the Output Channel then press SET.

44 Setup Menu

*9 O/P 1 Phase
PHASE: NORMAL



Use the ▲▼ keys to select either NORMAL (non-inverted) or REVERSE (inverted) Phase. Press SET to return to the main menu.

10 - Input Level

Use this menu item to alter the Input Channel Level. This is equivalent to moving the faders on the Input Window when running WinDR. The level can be varied from 0 to 100 in steps of 5. The table below gives level values against dB attenuation.

	100	95	90	85	80	75	70	65	60	55	50
dB	0	-1	-2	-3	-4	-5	-6	-7	-9	-11	-13



	45	40	35	30	25	20	15	10	5	0
dB	-15	-18	-21	-25	-30	-35	-40	-50	-60	OFF

*** Setup ***
*10 I/P Level





Press SET to select the Input Channel.

*10 I/P Level
I/P CHANNEL: 1

Use the ▲▼ keys to select the Input Channel then press SET.

*10 I/P 1 Level
LEVEL: 100

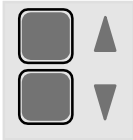
Use the ▲▼ keys to change the level from 0 to 100. Then Press SET.

11 - Output Level

Use this menu item to alter the Output Channel Level. This is equivalent to moving the faders on the Output Window when running WinDR. The level can be varied from 0 to 100 in steps of 5. The table below gives level values against dB attenuation.

	100	95	90	85	80	75	70	65	60	55	50
dB	0	-1	-2	-3	-4	-5	-6	-7	-9	-11	-13

	45	40	35	30	25	20	15	10	5	0
dB	-15	-18	-21	-25	-30	-35	-40	-50	-60	OFF

*** Setup ***
* 11 O/P Level



Press SET to select the Output Channel.

* 11 O/P Level
O/P CHANNEL: 1



Use the ▲▼ keys to select the Output Channel then press SET.

* 11 O/P 1 Level
LEVEL: 100



Use the ▲▼ keys to change the level from 0 to 100. Then Press SET.







12 - Crosspoint Matrix Levels

The level at each node of the 12 x 8 Cross-Point Mix Matrix can be adjusted using this menu item. The level can be varied from 0 to 100 in steps of 5. The table below gives level values against dB attenuation.

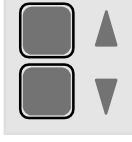
	100	95	90	85	80	75	70	65	60	55	50
dB	0	-1	-2	-3	-4	-5	-6	-7	-9	-11	-13

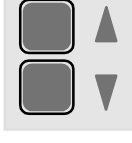
	45	40	35	30	25	20	15	10	5	0
dB	-15	-18	-21	-25	-30	-35	-40	-50	-60	OFF

46 Setup Menu





<div style="border: 1px solid black; padding: 5px;"> <p>*** Setup *** *12 Matrix</p> </div>		<p>Press SET to select the Input Channel.</p>
<div style="border: 1px solid black; padding: 5px;"> <p>*12 Matrix I/P CHANNEL: <u>1</u></p> </div>		<div style="display: flex; align-items: center;">  <p>Use the ▲▼ keys to select the Input Channel then press SET.</p> </div>
<div style="border: 1px solid black; padding: 5px;"> <p>*12 Matrix IP 1 O/P CHANNEL: <u>1</u></p> </div>		<div style="display: flex; align-items: center;">  <p>Use the ▲▼ keys to select the Output Channel then press SET.</p> </div>
<div style="border: 1px solid black; padding: 5px;"> <p>*12 I/P 1 O/P 1 LEVEL: <u>100</u></p> </div>		<div style="display: flex; align-items: center;">  <p>Use the ▲▼ keys to change the level from 0 to 100. Then Press SET.</p> </div>

13 - Function Key Setup

Each of the 12 Front Panel Function Keys can be programmed as one of the following functions.

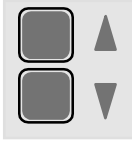
- Unused
- Input Level
- Output Level
- Patch Select
- Input Level Up
- Output Level Up
- Patch Recall
- Input Level Down
- Output Level Down

Different menu items are provided, depending on the function selected.

<div style="border: 1px solid black; padding: 5px;"> <p>*** Setup *** *13 Soft Keys</p> </div>		<p>Press SET to select the Function Key number</p>
<div style="border: 1px solid black; padding: 5px;"> <p>*13 Soft Keys KEY NUMBER: <u>1</u></p> </div>		<div style="display: flex; align-items: center;">  <p>Use the ▲▼ keys to select the Function Key then Press SET.</p> </div>
<div style="border: 1px solid black; padding: 5px;"> <p>*13 Key 1 Func. Fn: <u>UNUSED</u></p> </div>		<div style="display: flex; align-items: center;">  <p>Use the ▲▼ keys to select the Function Key then Press SET.</p> </div>

Function Key - Unused

If the Function Key is assigned as UNUSED, pressing the Key in normal mode will display 'Unused' in the bottom line of the LCD.

Function Key - Level Control









The following menu items are used when a Function Key assigned as I/P Level, I/P Level Up, I/P Level Down, O/P Level, O/P Level Up or O/P Level Down.

If the Function Key is assigned to I/P Level or O/P Level, in normal operation the level is controlled by pressing the Function Key and using the ▲▼ keys to control the level.

If the Function Key is assigned to I/P Level Up, I/P Level Down, or O/P Level Up, O/P Level Down, then in normal operation simply pressing the Function Key will increase or reduce the level directly.

In all cases, when a Function Key is assigned as a level control Trim Limits can be set. These give maximum & minimum levels that can be adjusted using the Function Key. Default values for the Trim limits are 0 (minimum) and 100 (maximum).

The example below is shown for I/P Level control.

<div style="border: 1px solid black; padding: 5px;"> <p>*13 Key 1 Func. Fn: I/P Level</p> </div>			<p>Use the ▲▼ keys to select the I/P Level function then Press SET.</p>
<div style="border: 1px solid black; padding: 5px;"> <p>*13 Level Key 1 I/P Channel: 1</p> </div>			<p>Use the ▲▼ keys to select the I/P Channel Level to control then Press SET.</p>
<div style="border: 1px solid black; padding: 5px;"> <p>*13 Level Key 1 MIN LEVEL: 0</p> </div>			<p>Use the ▲▼ keys to select the Minimum Trim Limit from 0 to 100 then Press SET.</p>
<div style="border: 1px solid black; padding: 5px;"> <p>*13 Level Key 1 MAX LEVEL: 100</p> </div>			<p>Use the ▲▼ keys to select the Maximum Trim Limit from 0 to 100 then Press SET.</p>

Function Key - Patch Select

If the Function Key is assigned as a Patch Select then in normal operation the user can recall any of the 16 Patches by pressing the Function Key and use the ▲▼ keys to select the Patch Number, then press SET to recall it.

48 Setup Menu

Function Key - Patch Recall

If the Function Key is assigned as a Patch Recall, then in normal operation simply pressing the Function Key will recall the Patch number selected here.

*13 Key 1 Func.
PATCH: 1



Use the ▲▼ keys to select the Patch Number to recall then Press SET.

14 - Remote Key Setup

The DR128's Rear Panel provides a 9-pin D-Type connector for connecting remote contact closure switches. These switches can be assigned various functions in a similar fashion to the Front Panel Function Keys. Each of the 8 Remote Switch Keys can be programmed as one of the following functions.

- Unused
- Patch Recall
- Input Level Up
- Input Level Down
- Output Level Up
- Output Level Down

Different menu items are provided, depending on the function selected.

*** Setup ***
*14 Remote Keys



Press SET to select the Remote Key number

*14 Remote Keys
KEY NUMBER: 1



Use the ▲▼ keys to select the Remote Key then Press SET.

The next menu item is used to select the Remote Key's job. The subsequent menu items will depend on the function selected.

Remote Key - Unused

*14 Key 1 Func.
Fn: UNUSED



Use the ▲▼ keys to select the Remote Key then Press SET.









Remote Key - Level Control

The following menu items are used when a Remote Key assigned as I/P Level Up, I/P Level Down, O/P Level Up, O/P Level Down.

If a Remote Key is assigned to I/P Level Up, I/P Level Down, or O/P Level Up, O/P Level Down, then in normal operation pressing the Remote Key will increment or decrement the level directly.



In all cases, when a Remote Key is assigned as a level control, Trim Limits can be set. These give maximum and minimum levels that can be adjusted using the Remote Key. Default values for the Trim limits are 0 (minimum) and 100 (maximum).

The example below is shown for I/P Level Up control.

<div style="border: 1px solid black; padding: 5px;"> <p>*14 Key 1 Func. Fn: <u>I/P LEVEL</u> ↑</p> </div>			<p>Use the ▲▼ keys to select the Remote Key's function then Press SET.</p>
<div style="border: 1px solid black; padding: 5px;"> <p>*14 Key 1 Func. I/P Channel: <u>1</u></p> </div>			<p>Use the ▲▼ keys to select the I/P Channel Level to control then Press SET.</p>
<div style="border: 1px solid black; padding: 5px;"> <p>*14 Level Key 1 MAX LEVEL: <u>100</u></p> </div>			<p>Use the ▲▼ keys to select the Maximum Trim Limit from 0 to 100 then Press SET.</p>
<p>In the case of I/P level Down, the above menu would specify the Minimum Trim limit.</p>			
<div style="border: 1px solid black; padding: 5px;"> <p>*14 Level Key 1 MIN LEVEL: <u>0</u></p> </div>			<p>Use the ▲▼ keys to select the Minimum Trim Limit from 0 to 100 then Press SET.</p>

Remote Key - Patch Recall

If the Remote Key is assigned as a Patch Recall, then in normal operation simply pressing the Remote Key will recall the Patch number selected here.

<div style="border: 1px solid black; padding: 5px;"> <p>*14 Key 1 Func. PATCH: <u>1</u></p> </div>			<p>Use the ▲▼ keys to select the Patch Number to recall then Press SET.</p>
--	---	---	---

50 Setup Menu

15 - Day of the Week

Use this menu item to set up Day of the Week of the internal clock. In Normal operation the day & time are displayed in the bottom line of the LCD. The time and day of the week are also used for programming timed events.

*** Setup ***
*15 Day of Week



Press SET to change the Day of the Week

*15 Day of Week
DAY: SATURDAY

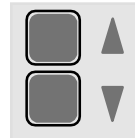

Use the ▲▼ keys to select the Day then Press SET.

16 - Clock

Use this menu item to set up the time of the internal Clock. In Normal operation the day & time are displayed in the bottom line of the LCD. The time and day of the week are also used for programming timed events.

*** Setup ***
*16 Clock



Press SET to change the Clock Time

*16 Clock
TIME: 18:43:31



Use the ▲▼ keys to select the Hour Tens then Press SET to move on to the hour units, minute tens and units, second tens and units until done.

17 - LCD Contrast

Use this item to adjust the LCD contrast for different ambient light conditions or viewing angle. Values are between 0 (light) and 10 (dark). The default value is 3.

*** Setup ***
*17 LCD Contrast



Press SET to change the LCD Contrast.

*17 LCD Contrast
CONTRAST: 3



Use the ▲▼ keys to adjust the contrast then press SET.

18 - New Password

Use this menu item to enter or change the system password. This 4 character password is used to get into Setup Mode if the Security feature is turned ON (see menu item 19 - Security). The default security settings are Password '????' and Security OFF.

*** Setup ***
*18 New Password



Press SET to set up a password or to change the current password.

If you are changing the current password and the Security feature is OFF you will be prompted to enter the current password.

*18 Enter P'word
CURRENT: "????"

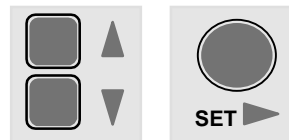

Use the ▲▼ keys to select each character for the Password - note that only uppercase characters are allowed. Use SET to move to the next character or ESC to move to the previous character.

You will then be prompted to enter the new password.

*18 Enter P'word
NEW: "????"

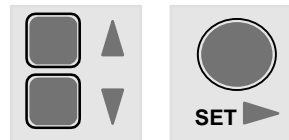

19 - Security

This menu item is used to turn the Password Security feature ON or OFF and is used to limit unauthorized access to the Setup Menus. Note that this menu item is hidden if a password hasn't been setup or if the password is '????'.

If a password has been setup then you will need to enter it to change the Security settings.

*** Setup ***
*19 Set Security



Press SET to change the Security settings.

*19 Set Security
PASSWORD: "????"

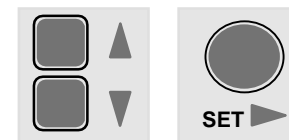

52 Setup Menu

Use the ▲▼ keys to select each character for the Password. Use SET to move to the next character.

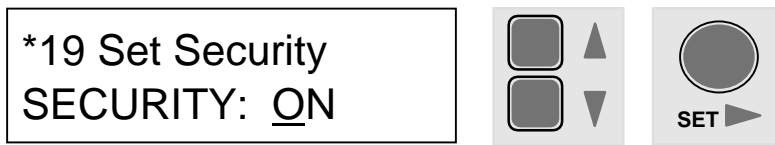

Use the ▲▼ keys to change the security from ON to OFF.

Forgotten Password?

In case of lost or forgotten passwords there is a method of resetting the password. Refer to the relevant section in the Appendix.

6

Appendix

Architect’s Specification 54

Technical Specifications..... 55

Connecting WinDR..... 56

Reseting the Password..... 60

Architect's Specification

The unit shall be a digital mix processor with 12 analogue inputs and 8 analogue outputs. The unit shall have a full crosspoint matrix, comprising 96 points, allowing any input, or combination of inputs, to be routed to any output or combination of outputs. All crosspoints shall have a variable level. The 8 mic/line inputs and 8 line level outputs shall be on balanced XLRs with level trims. The 4 stereo line inputs shall sum to mono and be on RCA phono connectors with level trims. Comprehensive ducking capability shall be provided.

The mic/line inputs shall have internal jumpers for pad and phantom power selection. The mic/line gain range shall be 18dB to 60dB with input impedance of 2k Ω (no pad) or 10k Ω (pad). The phono input gain sensitivity shall be internally adjustable from -10dBv to +4dBu with an impedance of 10k Ω . The inputs shall be converted using a 24 bit analogue-to-digital converter.

The XLR outputs shall have a variable sensitivity from -10dBV to +4dBu with an output impedance of 50 Ω . The conversion shall be by a 20 bit digital-to-analogue converter.

The unit shall be configured over a standard RS232 port using a proprietary 32-bit Windows™ based software application with a Graphical User Interface. Configurations shall be editable both on and off-line. The configuration shall determine the allocation of internal signal processing resources to input and output channels, as well as routing, passwords, levels and channel names. After configuration, the unit shall run standalone, without an external computer. Signal processing resources available shall include compressors, gates, limiters, graphic equalisers, parametric equalisers and crossovers. Optional expander cards shall provide the facility for additional signal processing resources and/or supplementary delay resources. The unit shall use Flash memory to permit firmware upgrades via the RS232 port. An internal real-time clock shall allow scheduling of timed events.

The unit shall be compatible with BS5839 installation requirements. The hybrid switched/linear power supply shall allow emergency operation with a single 24V external battery and the unit shall interface with alarm systems. The total power consumption shall be no more than 70VA and the permissible incoming mains voltage range shall be configurable to 100, 120, 220 or 230 VAC.

The front panel shall feature 12 installer-definable function keys for user control of volume levels and patches. A removable fascia shall enable custom labeling. There shall also be a backlit LCD for indication of setup menus, peak conditions, patch status and channel levels. Important system parameters, such as Patch Naming, Channel Naming, Limiter control, Ducking control, Phase reversal, Routing assignments, Date/Time, LCD contrast and Soft Key definitions shall be password-protected from user adjustment.

Facilities for remote switching of unit parameters shall be provided.

The unit shall weigh no more than 10kg in a 2U rack-mount chassis. The chassis shall be constructed from zintec steel and feature a removable top for configuration of internal jumpers and presets.

The unit shall be the Allen & Heath DR128 digital mix processor.

Technical Specifications

Headroom	+16dBu (+4dBu nominal operating level)		
Max Output	+16dBu		
Frequency Response	20Hz - 20kHz +/-1dB (+4dBu into 600 ohms)		
THD	0.005% @ 1kHz typical		
Dynamic Range	99 dB typical (Mic Input to Line Output)		
Hum & Noise	<-80dB measured rms 22Hz to 22kHz bandwidth		
Mic EIN	-127dB (150 Ohm source)		
Crosstalk @1kHz	>80dB Adjacent Input Channels		
Sampling Frequency	48kHz		
A/D Converter	24-bit Sigma-Delta 128-times oversampling		
D/A Converter	20-bit Sigma-Delta 128-times oversampling		
Processing	24-bit linear		
Mic Input Gain Control	external 42dB (60dB to 18dB) variable		
Mic/Line Pad	22dB internal link		
Line Input Gain Control	internal 12dB (-8dBu to +4dBu) variable		
Line Output Gain Control	internal 12dB (-8dBu to +4dBu) variable		
LCD Display	2 x 16 Character, backlit		
LED indicators	Tri-colour Programmable Signal levels	Green Red	On at -36dBFS On at -6dBFS
Function Keys	12 Programmable as Unused, Level controls or Patch changes		
Front Panel Meters	12 Programmable as Signal Meters or Status Indicators		
RS232	9 way female D-Type, unbalanced 57.6 kBaud		
Remote Switch Inputs	9 way female D-Type, 8 opto-isolated, programmable		
Patch Memories	16 internal		
Battery Operation	+24V DC +/-15% @ 3.5 Amps maximum		
Mains Settings	100 VAC	Fuse: T1.6A	
	120 VAC	Fuse: T1.6A	
	220 VAC	Fuse: T630mA	
	230 VAC	Fuse: T630mA	
Power Consumption	70 VA maximum		
Weight	Packed	10 kg	Unpacked 9.5 kg
Dimensions	482 x 380 x 89mm (rack mounting brackets fitted)		
Options	DSPx DSP Expander DSPd Delay Expander		

Connecting WinDR

To configure the DR128 from a remote PC using Allen & Heath WinDR System Manager software the following will be required:

System requirements:

Hardware

Pentium or better, or compatible processor
640 by 480 VGA video display (1024 by 768 recommended)
16MB RAM
10MB Hard disc drive free space
Mouse or other pointing device
3½" floppy disk drive
RS232 serial communications port

Software

Microsoft Windows 95™

Installing WinDR onto a PC.

WinDR can be installed from one of two sources:

- From 3½" floppy disks.
- Downloaded from the Allen & Heath Website.

IMPORTANT DO NOT INSTALL THIS SOFTWARE OVER A PREVIOUS VERSION.
--

This Setup utility will install WinDR System Manager into it's own directory so that previous versions of WinDR can be retained. A previous version can be un-installed by using the **Control Panel Add/Remove Programs** application from the Windows **Start/Settings** menu.

Installing WinDR from 3½" discs.

Allen & Heath WinDR System Manager software is a PC compatible Microsoft Windows 95 application. It is supplied on 3 disks. To install the software on a PC, follow the procedure below:

1. Insert disk number 1 into the 3½" floppy disk drive.
2. From the **Start** menu in Windows select **Run** and type *'a: \setup.exe'*.
3. When the Welcome screen is displayed, choose **Next**.

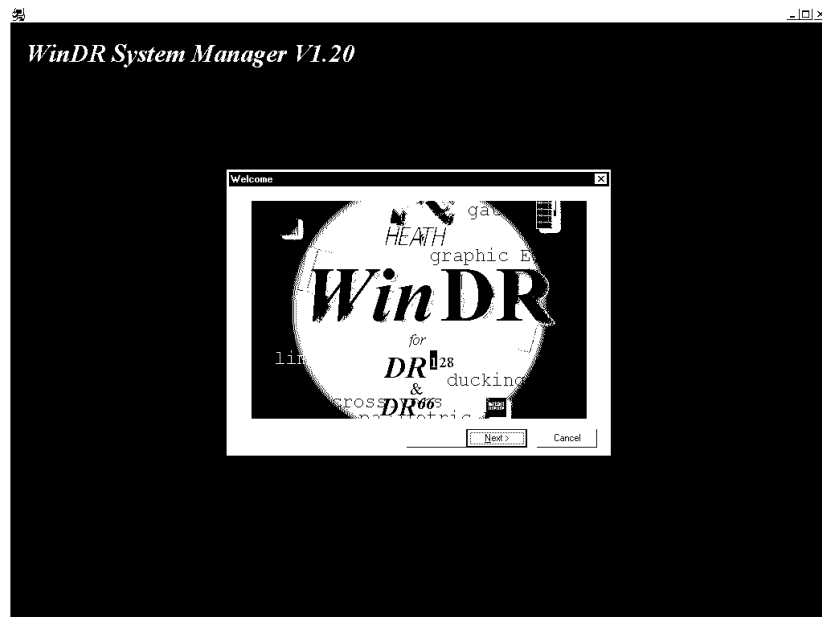

4. Follow the instructions displayed on the screen and insert the remaining disks when requested.
5. When WinDR has been installed successfully, the following final screen will be displayed, choose **Finish**.



IMPORTANT

Before running the WinDR application you **MUST** update the DR128/DR66's System Software to the same version using the 'DR128 System Update'/'DR66 System Update' utility. Run the 'Code Update Procedure' Help file in the WinDR program group for information on how to do this.

58 Appendix

Installing WinDR from the internet.

Allen & Heath WinDR System Manager software is a PC compatible Microsoft Windows 95™ application. It can be downloaded from the Allen & Heath Website. To install the software on a PC, follow the procedure below:

3. Log on to the Internet and access the Allen & Heath website. The address is:

<http://www.allen-heath.com>

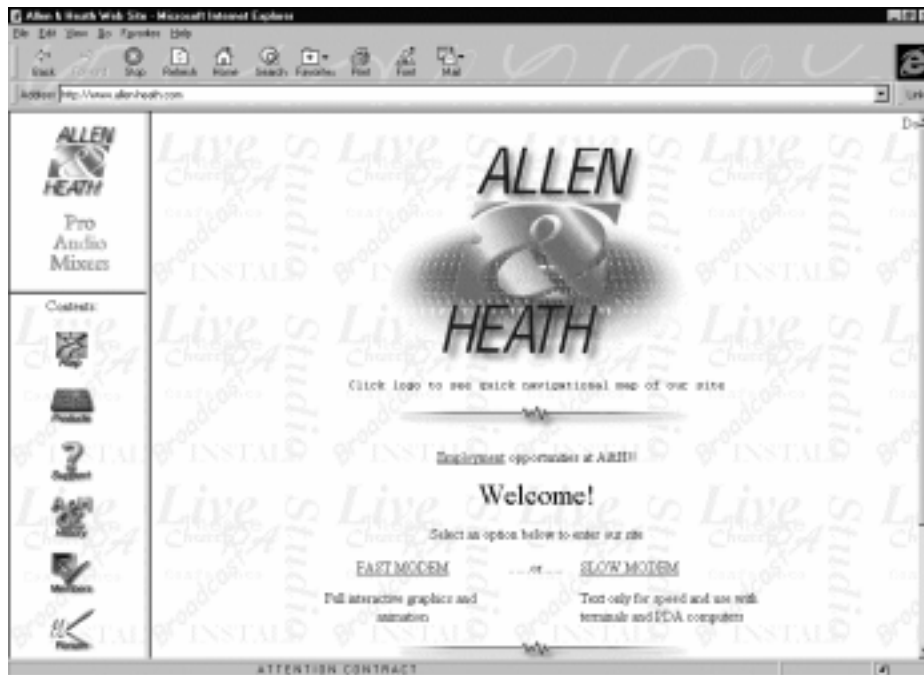

2. Select Products icon and scroll down to the DR128 section

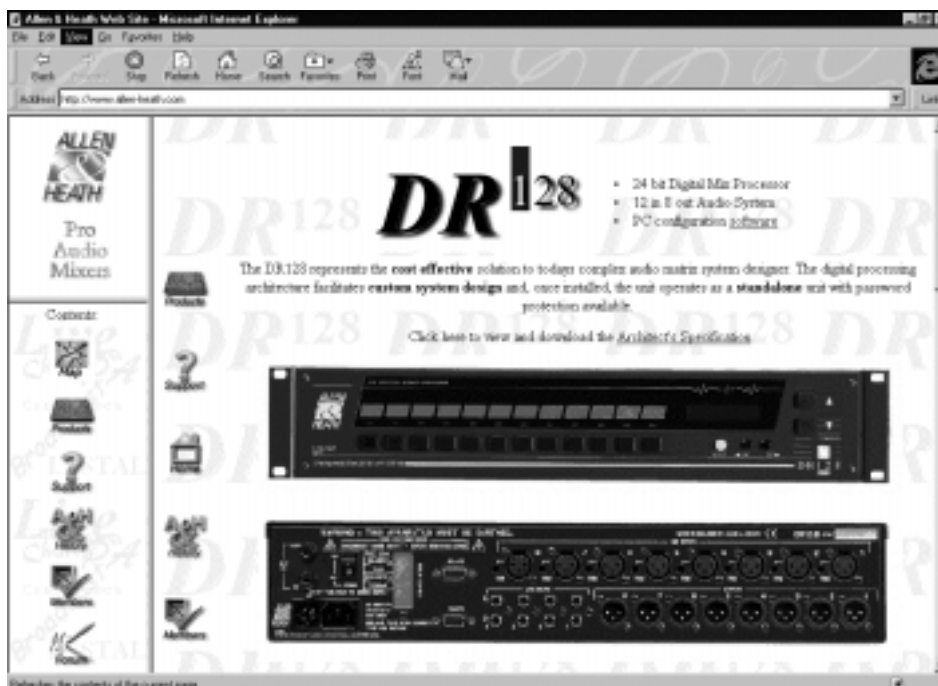

3. Click on **here** to download the latest version of the WinDR software which will also include the updated code for the DR128 unit.

IMPORTANT

Before running the WinDR application you MUST update the DR128/DR66's System Software to the same version using the 'DR128 System Update'/'DR66 System Update' utility. Run the 'Code Update Procedure' Help file in the WinDR program group for information on how to do this.

Connecting the DR128 to a remote PC.

To use WinDR running on a PC to configure the DR128 you will first have to connect the DR128 to the PC. This is done by connecting the RS232 port on the DR128 to the RS232 serial port on the remote PC.

DR128 RS232 9way D type	Signal
Pin 2	Tx
Pin 3	Rx
Pin 5	0V Ground

Pins 1, 4, 6, 7, 8, 9 = not connected
Connector chassis connected to chassis earth

Resetting the Password

The Front Panel Setup Menu can be password protected to prevent un-authorised tampering. If you lose or forget this password it can be reset using the procedure below.

First remove power from the DR128 and then remove the top cover. Locate and fit the password reset link on the CPU circuit board. The link is marked JP2 on the circuit board.

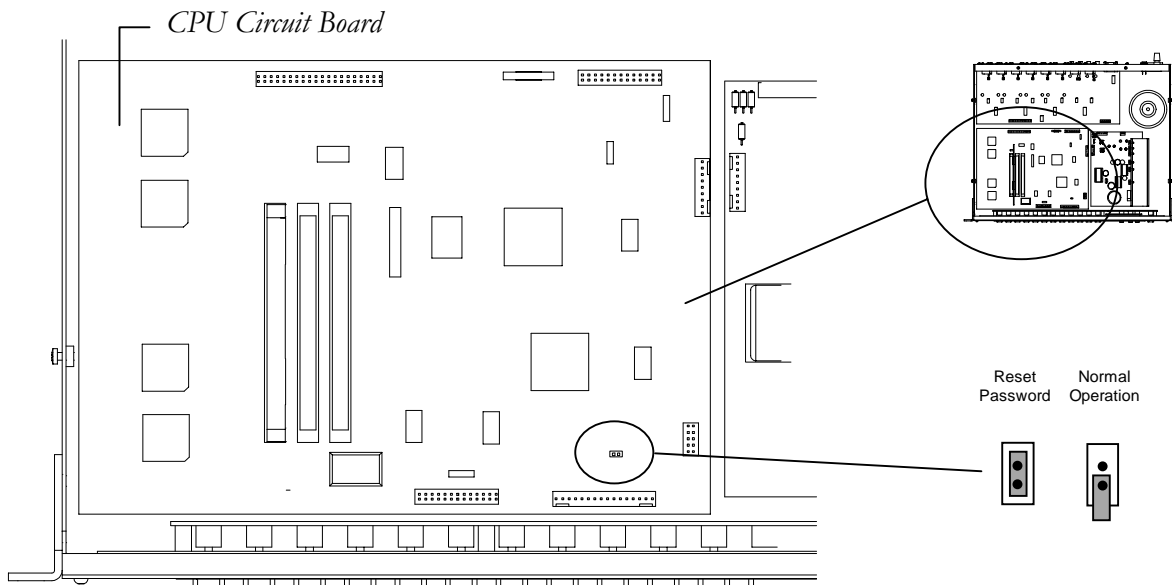

Switch on the DR128, the unit will detect that the link is fitted when it powers up, the password will be reset to '????' and the security turned OFF. Switch off the power again and remove the link before fitting the top cover.

If the link is left in place, then the password will reset each time the unit is powered up.