

KRAMER



USER MANUAL

MODEL:

VM-212DT

HDMI/HDBT Switcher/DA



VM-212DT HDMI/HDBT Switcher/DA Quick Start Guide

This guide helps you install and use your **VM-212DT** for the first time. For more detailed information, go to <http://www.kramerav.com/manual/VM-212DT> to download the latest manual or scan the QR code on the left.

Step 1: Check what's in the box

- ✓ **VM-212DT** HDMI/HDBT Switcher/DA
- ✓ 1 Quick Start Guide
- ✓ 4 Rubber feet
- ✓ 1 Power cord
- ✓ 1 Set rack "ears"

Step 2: Install the VM-212DT

To mount the **VM-212DT** in a rack, attach both "ear" brackets to the device using the three screws on each side of the device. Alternatively, attach the rubber feet to the bottom of the device and place it on a table.

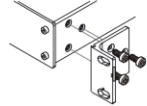

Step 3: Connect the inputs and outputs

Always switch off the power to each device before connecting it to your **VM-212DT**.
For best results, always use Kramer high-performance cables to connect your AV equipment to the **VM-212DT**.

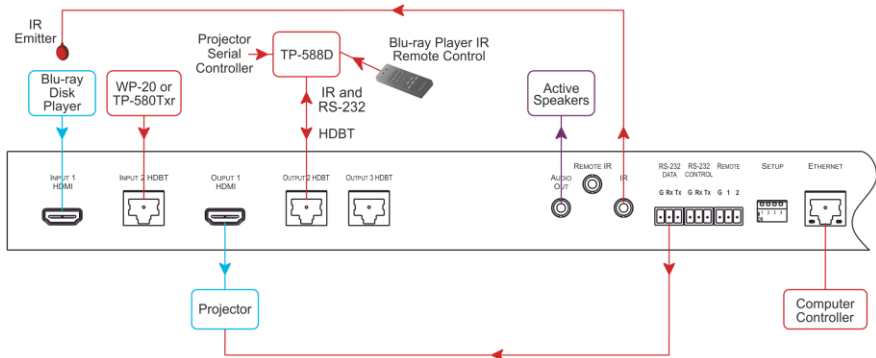

Step 4: Connect the power

Connect AC power to the rear of the **VM-212DT**, switch on its power and then switch on the power to each device.

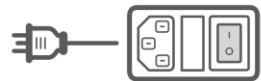

Step 5: Operate the device

You can operate the VM-212DT via any of the following methods:

- Front panel buttons
- Protocol 3000 commands over RS-232 or Ethernet
- Embedded Web pages, (see Chapter 9 in the User Manual)

VM-212DT Front Panel

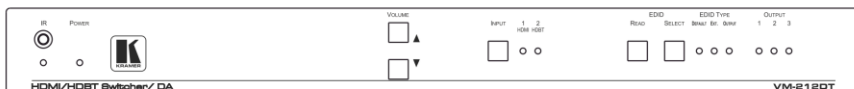

To acquire the EDID:

1. Press the EDID Select button repeatedly until the required EDID source is selected, (either Default, Ext, or one of the outputs). The relevant LED lights green.
2. Press the EDID READ button.
The EDID Read button lights red for a short while and the EDID is copied to the currently selected input. If the EDID Read button flashes once, this indicates that the EDID was not read and the device reverts to the last stored EDID, as indicated by the LEDs.

Note: If the EDID Read button is not pressed for a few seconds, the procedure is terminated and the device does not store a new EDID.

To select an input:

- Press the Input button to toggle between the inputs.
The relevant input LED lights green

Protocol 3000 over RS-232 and Ethernet

Command	Description	Command	Description
#	Protocol handshaking	LOGOUT	Cancel current permission level
AUD-LVL	Set/get audio level in specific amplifier stage	MODEL?	Read device model
AV-SW-TIMEOUT	Set/get video auto-switch timeout	MUTE	Set/get audio mute
BUILD-DATE?	Read device build date	NAME	Set/get machine (DNS) name
CPEDID	Copy EDID data from the output to the input	NAME-RST	Reset machine name to factory default (DNS)
DIR	List files in device	NET-DHCP	Set/get DHCP mode
DISPLAY?	Get output HPD status	NET-GATE	Set/get gateway IP
DPSW-STATUS?	Get the DIP-switch status	NET-IP	Set/get IP address
ETH-PORT	Set/get Ethernet port protocol	NET-MAC?	Get MAC address
FACTORY	Reset to factory default configuration	NET-MASK	Set/get subnet mask
FPGA-VER?	Get current FPGA version	PASS	Set/get Password
FS-FREE?	Get file system free space	PING	Sends ICMP ECHO
GEDID	Read EDID data	PROT-VER?	Get device protocol version
GET	Get file	RESET	Reset device
HDCP-MOD	Set/get HDCP mode	ROUTE	Set/get layer routing
HDCP-STAT?	Get HDCP signal status	SECUR	Start/Stop Security
HELP?	Get command list	SIGNAL?	Get input signal lock status
LDEDID	Write EDID data to input	SN?	Read device serial number
LOGIN	Set/get protocol permission	VERSION?	Read device firmware version

Contents

1	Introduction	1
2	Getting Started	2
2.1	Achieving the Best Performance	2
2.2	Safety Instructions	2
2.3	Recycling Kramer Products	3
3	Overview	4
3.1	Using Twisted Pair Cable	4
3.2	About HDBaseT™ Technology	5
4	Defining the VM-212DT HDMI/HDBT Switcher/DA	6
5	Installing in a Rack	8
6	Connecting the VM-212DT	9
6.1	Connecting to the VM-212DT via RS-232	10
6.2	Wiring the RJ-45 Connectors	11
7	Operating the VM-212DT	12
7.1	Acquiring the EDID	12
7.2	RS-232 and IR Control and Pass-Through	12
8	Operating the VM-212DT Remotely Using the Web Pages	17
8.1	Browsing the VM-212DT Web Pages	17
8.2	The Switching Page	20
8.3	The Video and Audio Settings Page	22
8.4	The Output Settings Page	23
8.5	The EDID Management Page	24
8.6	The Data Switching Page	27
8.7	The Authentication Page	29
8.8	The Device Settings Page	30
8.9	The Firmware Upgrade Page	33
8.10	The About Us Page	35
9	Configuring the VM-212DT	36
9.1	Setting the DIP-switch	36
9.2	Performing a Factory Reset	36
10	Technical Specifications	37
10.1	Default IP Parameters	38
10.2	Default Logon Credentials	38
10.3	Supported PC Web Browsers	38
11	Default EDID	39
12	Protocol 3000	41
12.1	Kramer Protocol 3000 Syntax	41
12.2	Kramer Protocol 3000 Commands	44

Figures

Figure 1: VM-212DT HDMI/HDBT Switcher/DA Front Panel	6
Figure 2: VM-212DT HDMI/HDBT Switcher/DA Rear Panel	7
Figure 3: Connecting the VM-212DT HDMI/HDBT Switcher/DA	9
Figure 4: TP PINOUT	11
Figure 5: VM-212DT RS-232 Control and Pass-Through	13
Figure 6: VM-212DT IR Pass-Through Example 1	14
Figure 7: VM-212DT IR Pass-Through Example 2	15
Figure 8: VM-212DT IR Pass-Through Example 3	16
Figure 9: Entering Logon Credentials	17
Figure 10: The Default Page	18
Figure 11: The Main Switching Page	18
Figure 12: The Switching Page	20
Figure 13: Input Button	21
Figure 14: Input Button Label Editor	21
Figure 15: The Audio Settings Page	22
Figure 16: The Output Settings Page	23
Figure 17: The EDID Management Page	24
Figure 18: The Data Switching Page	27
Figure 19: RS-232 Switching Example	28
Figure 20: IR Switching Example	28
Figure 21: The Authentication Page	29
Figure 22: The Device Settings Page	30
Figure 23: The IP Address Changes Popup Warning	31
Figure 24: The Factory Reset Popup Warning	32
Figure 25: The Firmware Upgrade Window	33
Figure 26: The Firmware Upgrade Warning Popup	34
Figure 27: The Firmware Upgrade Process Popup	34
Figure 28: The About Us Page	35
Figure 29: The Configuration DIP-switch	36

1 Introduction

Welcome to Kramer Electronics! Since 1981, Kramer Electronics has been providing a world of unique, creative, and affordable solutions to the vast range of problems that confront video, audio, presentation, and broadcasting professionals on a daily basis. In recent years, we have redesigned and upgraded most of our line, making the best even better!

Our 1,000-plus different models now appear in 14 groups that are clearly defined by function: GROUP 1: Distribution Amplifiers; GROUP 2: Switchers and Routers; GROUP 3: Control Systems; GROUP 4: Format/Standards Converters; GROUP 5: Range Extenders and Repeaters; GROUP 6: Specialty AV Products; GROUP 7: Scan Converters and Scalers; GROUP 8: Cables and Connectors; GROUP 9: Room Connectivity; GROUP 10: Accessories and Rack Adapters; GROUP 11: Sierra Video Products; GROUP 12: Digital Signage; GROUP 13: Audio; and GROUP 14: Collaboration.

Congratulations on purchasing your Kramer **VM-212DT HDMI/HDBT Switcher/DA**. This product, which incorporates HDMI™ technology, is ideal for:

- Presentation and multimedia applications
- Rental and staging

2 Getting Started

We recommend that you:

- Unpack the equipment carefully and save the original box and packaging materials for possible future shipment
- Review the contents of this user manual



Go to www.kramerav.com/downloads/VM-212DT to check for up-to-date user manuals, application programs, and to check if firmware upgrades are available (where appropriate).

2.1 Achieving the Best Performance

To achieve the best performance:

- Use only good quality connection cables (we recommend Kramer high-performance, high-resolution cables) to avoid interference, deterioration in signal quality due to poor matching, and elevated noise levels (often associated with low quality cables)
- Do not secure the cables in tight bundles or roll the slack into tight coils
- Avoid interference from neighboring electrical appliances that may adversely influence signal quality
- Position your **VM-212DT** away from moisture, excessive sunlight and dust



This equipment is to be used only inside a building. It may only be connected to other equipment that is installed inside a building.

2.2 Safety Instructions



Caution: There are no operator serviceable parts inside the unit

Warning: Use only the power cord that is supplied with the unit

Warning: Do not open the unit. High voltages can cause electrical shock! Servicing by qualified personnel only

Warning: Disconnect the power and unplug the unit from the wall before installing

2.3 Recycling Kramer Products

The Waste Electrical and Electronic Equipment (WEEE) Directive 2002/96/EC aims to reduce the amount of WEEE sent for disposal to landfill or incineration by requiring it to be collected and recycled. To comply with the WEEE Directive, Kramer Electronics has made arrangements with the European Advanced Recycling Network (EARN) and will cover any costs of treatment, recycling and recovery of waste Kramer Electronics branded equipment on arrival at the EARN facility. For details of Kramer's recycling arrangements in your particular country go to our recycling pages at <http://www.kramerelectronics.com/support/recycling/>.

3 Overview

The **VM-212DT HDMI/HDBT Switcher/DA** is a switcher/distribution amplifier for HDMI and HDBT signals. It reclocks and equalizes one of two selectable input signals (HDMI or HDBT) and distributes it to one HDMI and two HDBT outputs.

In particular, the **VM-212DT** features:

- Support for 4K UHD (maximum data rate of 10.2Gbps)
- Non-volatile memory that stores the default EDID so it can then provide the EDID information to the source even if the display device is not connected
- I-EDIDPro™ Kramer Intelligent EDID Processing™, an intelligent EDID handling & processing algorithm that ensures Plug and Play operation for HDMI systems
- HDMI support for 3D, Deep Color, x.v.Color™ and 7.1 uncompressed audio channels (Dolby TrueHD, DTS-HD)
- HDCP compliance
- LEDs indicating the selected input and active output
- IR remote control support and a remote IR 3.5mm mini jack
- A 1U rack mount enclosure
- Support for up to 130m (430ft) in normal mode for 1080p @60Hz @36bpp, and up to 100m (328ft) for 4K UHD @30Hz when using **BC-HDKat6a** cables

3.1 Using Twisted Pair Cable

Kramer engineers have developed special twisted pair cables to best match our digital twisted pair products; the Kramer: **BC-HDKat6a** (CAT 6 23 AWG cable), and the Kramer: **BC-DGKat7a23** (CAT 7a 23 AWG cable). These specially built cables significantly outperform regular CAT 6 / CAT 7a cables.

3.2 About HDBaseT™ Technology

HDBaseT™ is an advanced, all-in-one connectivity technology (supported by the HDBaseT Alliance). It is particularly suitable in the ProAV – and also the home – environment as a digital networking alternative, where it enables you to replace numerous cables and connectors by a single LAN cable used to transmit, for example, uncompressed, full high-definition video, audio, IR, as well as various control signals.



The products described in this user manual are HDBaseT certified.

4 Defining the VM-212DT HDMI/HDBT Switcher/DA

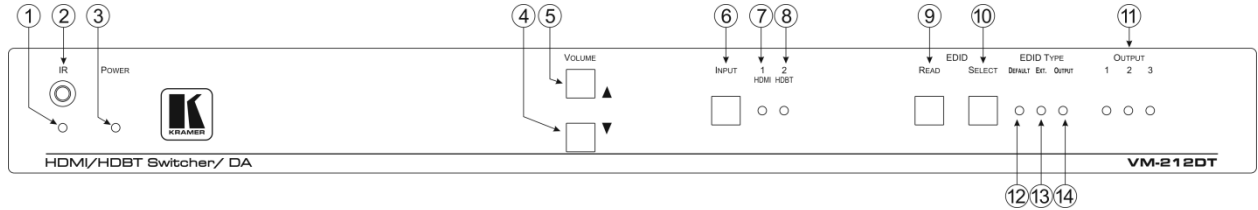

Figure 1: VM-212DT HDMI/HDBT Switcher/DA Front Panel

#	Feature	Function
1	IR LED	Lights yellow when receiving signals from the IR remote sensor
2	IR Remote Control Sensor	Sensor for an IR transmitter. IR data is routed according to the IR routing configuration, (see Section 8.6)
3	POWER LED	Lights green when the unit receives power
4	VOLUME Buttons	▼ Down button Press to decrease the audio volume
5		▲ Up button Press to increase the audio volume
6	INPUT Button	Press to toggle between HDMI Input 1 and HDBT Input 2. Lights red when the input is valid, selected and routing to an output(s)
7	1 HDMI LED	Lights green when HDMI 1 Input is selected
8	2 HDBT LED	Lights green when HDBT 2 Input is selected
9	EDID Buttons	READ Button Press to read the selected EDID to both inputs, (see Section 7.1)
10		SELECT Button Press to cycle through the EDID sources, (default, external, and each output) from which to read the EDID. The relevant LED lights green, (see Section 7.1)
11	OUTPUT LEDs 1 to 3	The relevant LED lights during EDID setup, (see Section 7.1)
12	EDID TYPE LEDs	DEFAULT Lights green when the default EDID is selected, (see Section 7.1)
13		EXT. Lights green when an external EDID is selected
14		OUTPUT Lights green when one of the output EDIDs is selected

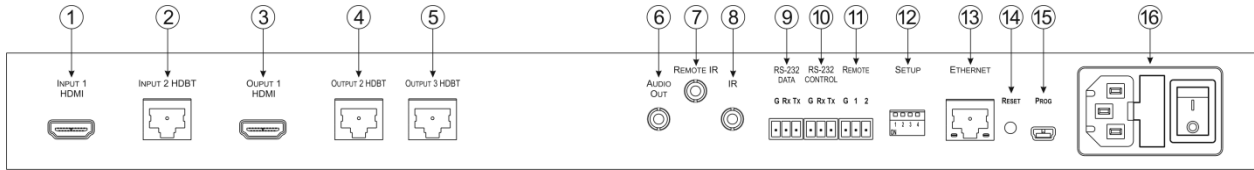

Figure 2: VM-212DT HDMI/HDBT Switcher/DA Rear Panel

#	Feature	Function
1	INPUT 1 HDMI Local Input	Connect to the HDMI source
2	INPUT 2 HDBT Remote Input	Connect to the remote HDBT transmitter, (for example, the WP-20 or TP-580Txr)
3	OUTPUT 1 HDMI Local Output	Connect to the HDMI acceptor
4	OUTPUT HDBT Connectors	2
5		3
6	AUDIO OUT 3.5mm Mini Jack	Connect to the analog audio acceptor
7	REMOTE IR 3.5mm Mini Jack	For future use
8	IR 3.5mm Mini Jack	Connect to the remote IR sensor/emitter
9	RS-232 DATA 3-pin Terminal Block	Connect to the device to be controlled via RS-232
10	RS-232 CONTROL 3-pin Terminal Block	Connect to the serial controller to control the VM-212DT
11	REMOTE 3-pin Terminal Block	For future use
12	SETUP 4-way DIP-switch	Used to set the device behavior, (see Section 9.1)
13	ETHERNET RJ-45 Connector	Connect to a remote network controller via a LAN
14	RESET Switch	Press and hold while powering on the device to reset to factory default parameters, (see Section 9.2)
15	PROG Mini USB Connector	Connect to a PC to perform firmware upgrades
16	Mains Power Connector, Fuse, and Switch	Connect to the mains supply

5 Installing in a Rack

This section provides instructions for rack mounting the unit.

Before installing in a rack, be sure that the environment is within the recommended range:

OPERATING TEMPERATURE:	0° to +40°C (32° to 104°F)
STORAGE TEMPERATURE:	-40° to +70°C (-40° to 158°F)
HUMIDITY:	10% to 90%, RHL non-condensing



CAUTION!

When installing on a 19" rack, avoid hazards by taking care that:

1. It is located within the recommended environmental conditions, as the operating ambient temperature of a closed or multi unit rack assembly may exceed the room ambient temperature.
2. Once rack mounted, enough air will still flow around the machine.
3. The machine is placed straight in the correct horizontal position.
4. You do not overload the circuit(s). When connecting the machine to the supply circuit, overloading the circuits might have a detrimental effect on overcurrent protection and supply wiring. Refer to the appropriate nameplate ratings for information. For example, for fuse replacement, see the value printed on the product label.
5. The machine is earthed (grounded) in a reliable way and is connected only to an electricity socket with grounding. Pay particular attention to situations where electricity is supplied indirectly (when the power cord is not plugged directly into the socket in the wall), for example, when using an extension cable or a power strip, and that you use only the power cord that is supplied with the machine.

To rack-mount a machine:

1. Attach both ear brackets to the machine. To do so, remove the screws from each side of the machine (3 on each side), and replace those screws through the ear brackets.

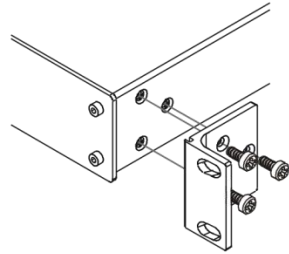

2. Place the ears of the machine against the rack rails, and insert the proper screws (not provided) through each of the four holes in the rack ears.

Note:

- In some models, the front panel may feature built-in rack ears
- Detachable rack ears can be removed for desktop use
- Always mount the machine in the rack before you attach any cables or connect the machine to the power
- If you are using a Kramer rack adapter kit (for a machine that is not 19"), see the Rack Adapters user manual for installation instructions available from our Web site

6 Connecting the VM-212DT



Always switch off the power to each device before connecting it to your **VM-212DT**. After connecting your **VM-212DT**, connect its power and then switch on the power to each device.

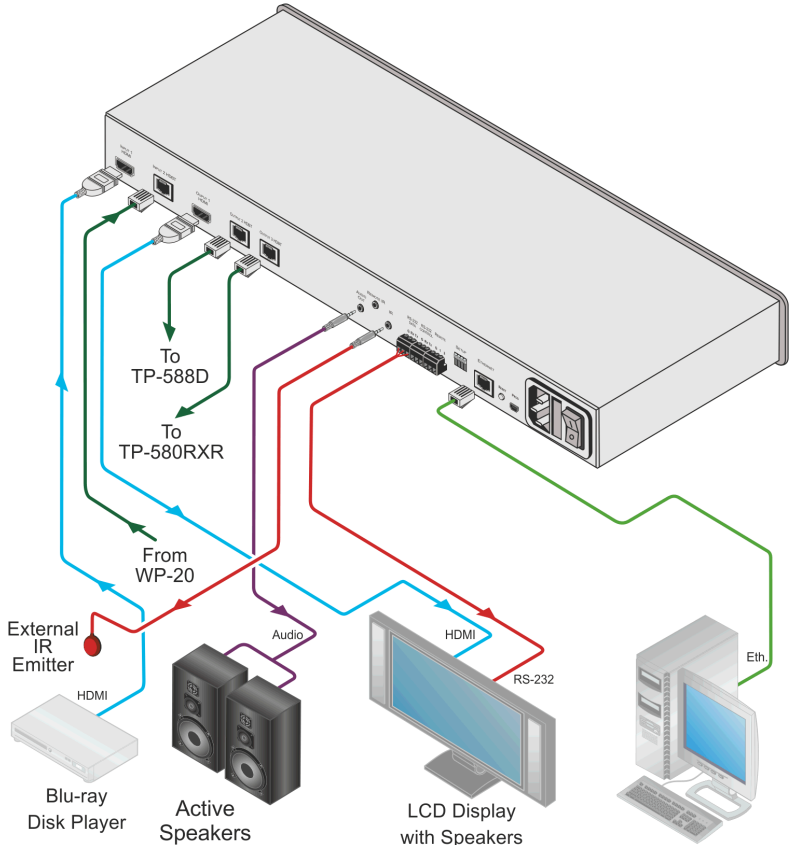

Figure 3: Connecting the VM-212DT HDMI/HDBT Switcher/DA

To connect the **VM-212DT**, as illustrated in the example in [Figure 3](#):

1. Connect the HDMI source (for example, a Blu-ray disk player) to the IN 1 (HDMI) connector.

2. Connect the HDBT source, (for example, the **WP-20**) to the Input 2 HDBT connector.
3. Connect the Output 1 HDMI connector to an HDMI acceptor, (for example, an LCD TV with speakers).
4. Connect the two Output HDBT connectors to up to two HDBT receivers, (for example, the **TP-588D** or the **TP-580RXR**).
5. Connect the Audio Out 3.5mm mini jack to an audio acceptor (for example, active speakers).
6. Connect an IR emitter to the IR 3.5mm mini jack.
7. Connect the serial RS-232 Data 3-pin terminal block to a device to be controlled, (for example, the LCD TV connected in step 3).
8. Connect a PC via RS-232 to the RS-232 Control 3-pin terminal block, (see [Section 6.1](#)).
9. Connect the **VM-212DT** to the mains electricity using the mains cord provided.

6.1 Connecting to the VM-212DT via RS-232

You can connect to the **VM-212DT** via an RS-232 connection using, for example, a PC.

To connect to the VM-212DT via RS-232:

- Connect the 3-pin terminal block serial port on the **VM-212DT** to the RS-232 9-pin D-sub port on your PC, (pin Tx to pin 2, pin Rx to pin 3, and G to pin 5)

6.2 Wiring the RJ-45 Connectors

This section defines the TP pinout, using a straight pin-to-pin cable with RJ-45 connectors.

EIA /TIA 568B	
PIN	Wire Color
1	Orange / White
2	Orange
3	Green / White
4	Blue
5	Blue / White
6	Green
7	Brown / White
8	Brown

Figure 4: TP PINOUT

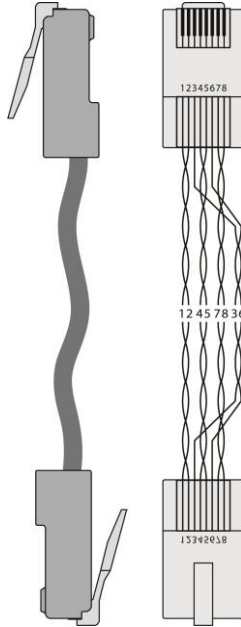

7 Operating the VM-212DT

7.1 Acquiring the EDID

Each input on the **VM-212DT** has a factory default EDID loaded (see [Section 11](#)). This lets you connect the power before having to connect one of the acceptors. The **VM-212DT** reads the EDID, which is stored in the non-volatile memory.

The following procedure is usually done only once, when the device is being set up.

To acquire the EDID:

1. Press the EDID Select button repeatedly until the required EDID source is selected, (either Default, Ext, or one of the outputs).
The relevant LED lights green.
2. Press the EDID READ button.
The EDID Read button lights red for a short while and the EDID is copied to the currently selected input. If the EDID Read button flashes twice after the first flash this indicates that the EDID was not read and the device reverts to the last stored EDID, as indicated by the LEDs.

Note: If the EDID READ button is not pressed for five seconds, the procedure is terminated and the device does not store a new EDID. The last EDID is restored.

The EDID can also be modified using **EDID Designer**.

7.2 RS-232 and IR Control and Pass-Through

The **VM-212DT** can be controlled via RS-232 and infrared. Depending on how the RS-232 and IR connections are configured, the device either responds to control signals or transparently passes them through to another receiver or transmitter.

7.2.1 RS-232 Control and Pass-Through Using the VM-212DT

As shown in [Figure 5](#), you can connect a PC (or other serial controller) directly to the **VM-212DT** to control the **VM-212DT**.

The **VM-212DT** also transparently passes bidirectional RS-232 signals over the TP cable from the **TP-580Txr** transmitter to the **TP-580Rxr** receiver. For example, a PC connected to the RS-232 port on the **TP-580Txr** can control an RS-232-controllable device (for example, a projection screen) connected to the **TP-580Rxr**.

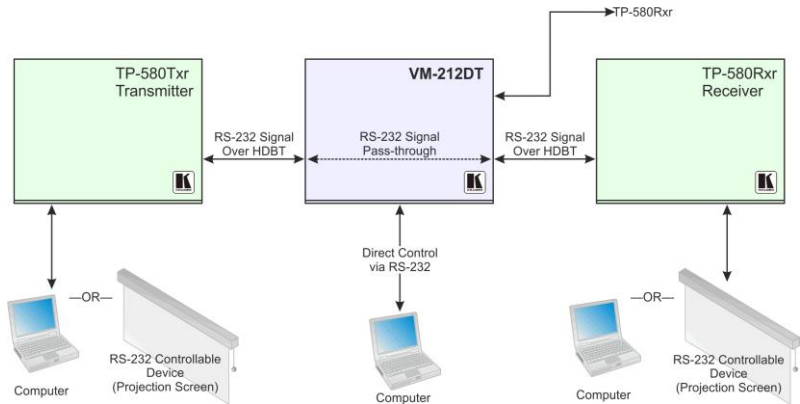

Figure 5: VM-212DT RS-232 Control and Pass-Through

7.2.2 Local IR Control and IR Pass-Through Using the VM-212DT

The **VM-212DT** provides an IR sensor and a 3.5mm mini jack for connecting a remote IR emitter or sensor. When the **VM-212DT** is connected to suitable transmitters and receivers (for example, the **TP-580Txr** and **TP-580Rxr**), the **VM-212DT** can act as a pass-through for IR control signals, allowing remote control of multiple devices using multiple IR remote controllers.

7.2.2.1 IR Pass-Through Example 1

The configuration is shown in [Figure 6](#).

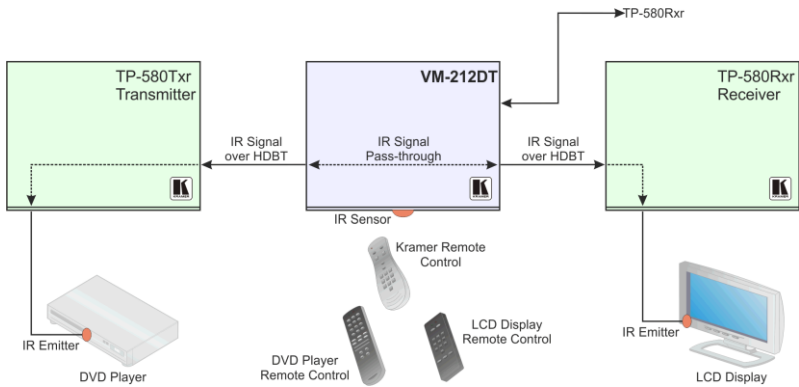

Figure 6: VM-212DT IR Pass-Through Example 1

- A DVD player is connected to the **TP-580Txr** transmitter via an IR emitter
- An LCD display is connected to the **TP-580Rxr** receiver via an IR emitter
- Both the **TP-580Txr** and the **TP-580Rxr** are connected to the **VM-212DT** via TP cabling

Point the appropriate remote control for the device at the **VM-212DT** IR sensor to control a device.

7.2.2.2 IR Pass-Through Example 2

The configuration is shown in [Figure 7](#).

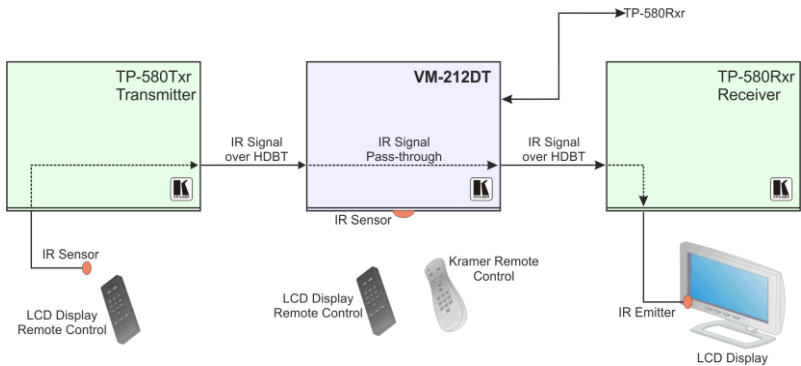

Figure 7: VM-212DT IR Pass-Through Example 2

- An IR sensor is connected to the **TP-580Txr** transmitter
- An LCD display is connected to the **TP-580Rxr** receiver via an IR emitter
- Both the **TP-580Txr** and the **TP-580Rxr** are connected to the **VM-212DT** via TP cabling

Point the LCD display remote control either at the **TP-580Txr** IR sensor or at the **VM-212DT** IR sensor to control the LCD display.

8 Operating the VM-212DT Remotely Using the Web Pages

The **VM-212DT** can be operated remotely using the embedded Web pages. The Web pages are accessed using a Web browser and an Ethernet connection.

Before attempting to connect:

- Ensure that your browser is supported (see [Section 10.1](#))
- Ensure that JavaScript is enabled

8.1 Browsing the VM-212DT Web Pages

Note: In the event that a Web page does not update correctly, clear your Web browser's cache by pressing CTRL+F5.

To browse the VM-212DT Web pages:

1. Open your Internet browser.
2. Type the IP number of the device (see [Section 10.1](#)) in the Address bar of your browser.



Note: If authentication is enabled, the following window appears ([Figure 9](#)) and you must enter the valid username and password to access the Web pages. For default authentication details, see [Section 10.2](#).

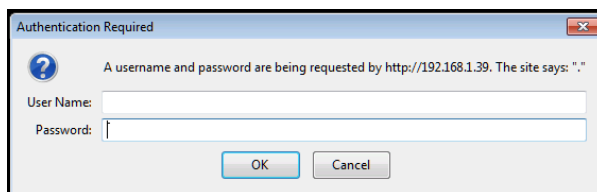

Figure 9: Entering Logon Credentials

Following a successful logon, the screen shown in [Figure 10](#) is displayed.

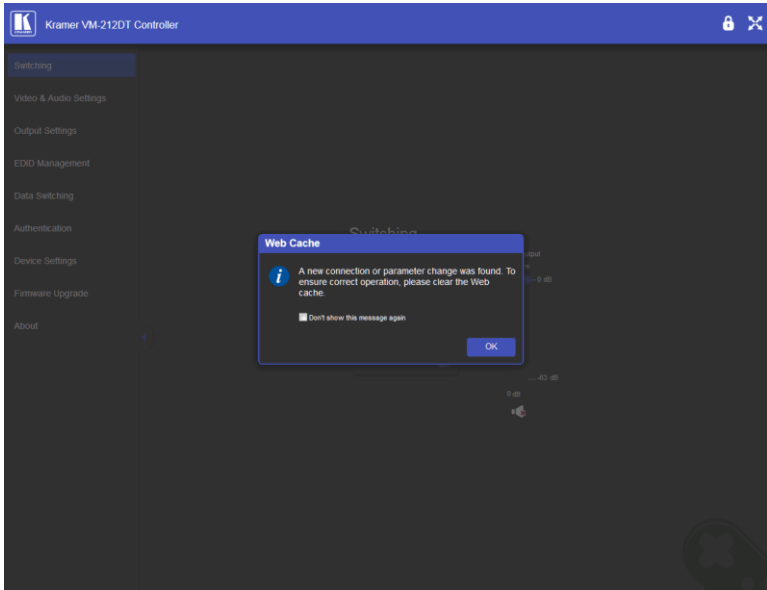

Figure 10: The Default Page

3. Click OK to continue.

The Switching page appears as shown in [Figure 11](#).

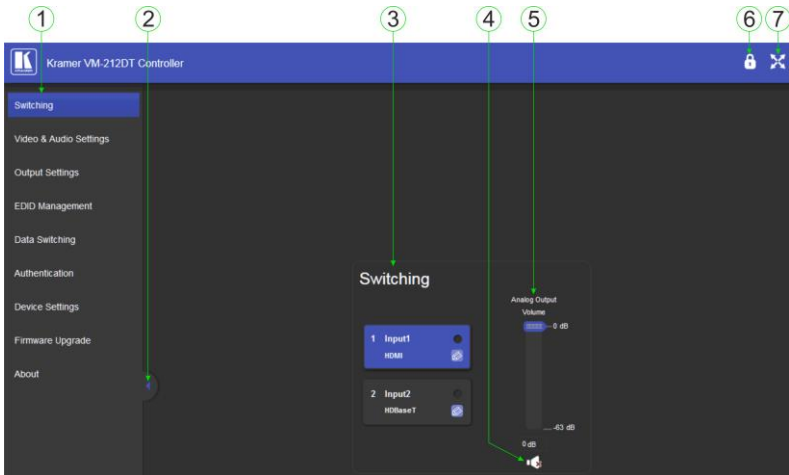

Figure 11: The Main Switching Page

The areas of the main switching page are described in the following table.

#	Item	Description
1	Page Selection Panel	Click one of the buttons to select a page
2	Page Selection Panel Hide/Reveal Button	Click the arrow to open or close the page selection panel
3	<i>Switching</i> Selection	Click one of the buttons to select an input
4	Mute Button	Click to mute the audio, Click again to unmute the audio
5	<i>Analog Output Volume Control</i>	Use the slider to control the audio volume
6	Security Indicator	Indicates whether security is enabled (locked) or disabled (unlocked)
7	Full Screen Button	Click to maximize the page

There are nine Web pages described in the following sections:

- Switching (see [Section 8.2](#))
- Video and Audio Settings (see [Section 8.3](#))
- Output Settings (see [Section 8.4](#))
- EDID Management (see [Section 8.5](#))
- Data Switching (see [Section 8.6](#))
- Authentication (see [Section 8.7](#))
- Device Settings (see [Section 8.8](#))
- Firmware Upgrade (see [Section 8.9](#))
- About (see [Section 8.10](#))

8.2 The Switching Page

The Switching page lets you select a video input manually and adjust the audio volume.

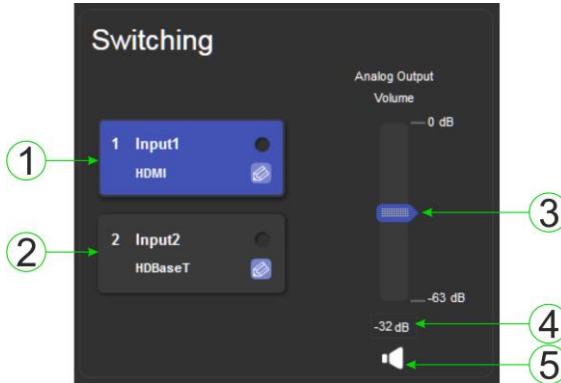

Figure 12: The Switching Page

#	Item	Description
1	<i>Input 1 HDMI</i> Button	Click to select the HDMI input. The color of the button indicates whether or not the input is selected. The color circle indicates whether or not there is a live signal on the input
2	<i>Input 2 HDBaseT</i> Button	Click to select the HDBaseT input. The color of the button indicates whether or not the input is selected. The color circle indicates whether or not there is a live signal on the input
3	<i>Analog Output Volume</i> Slider	Slide up to increase the analog output volume or down to decrease the volume
4	Audio Output Level	Indicates the current audio output level in dB
5	Mute Button	Click to mute or unmute the output audio

The input selection buttons function as described below.

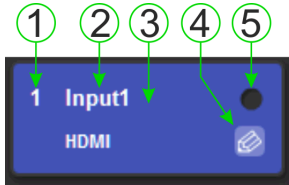

Figure 13: Input Button

#	Description
1	Input number
2	Customizable input button label. See description below
3	Button background color. When the input is selected the background changes from gray to blue
4	Label edit button
5	Live signal indicator. Lights when the input has a live signal on the input

To edit the button label:

1. Click the relevant edit button. 

The popup shown in [Figure 14](#) appears.

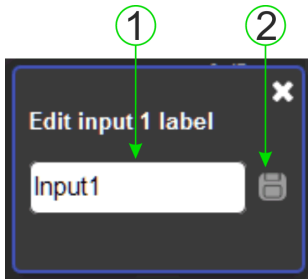



Figure 14: Input Button Label Editor

2. Enter the required label.
3. Click Enter or the Save button. 

#	Description
1	Label text entry box
2	Save button. Click button to save changes after entering the required label text

8.3 The Video and Audio Settings Page

The Video and Audio Settings page lets you modify the output power off delay, HDCP support per input, and audio de-embedding.

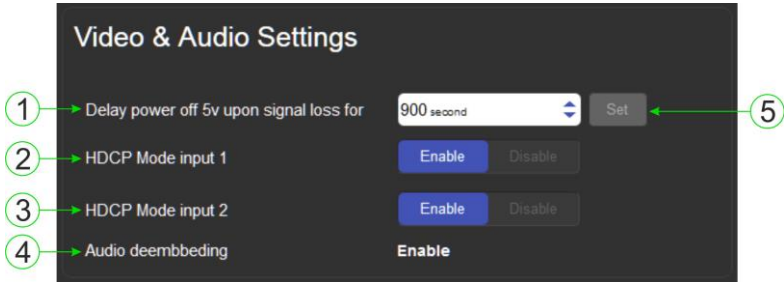

Figure 15: The Audio Settings Page

#	Item	Description
1	<i>Delay power off 5V upon signal loss for Box</i>	Sets the delay for turning off the 5V output because of a signal loss on the currently selected input. Value in seconds
2	<i>HDCP Mode input 1 Buttons</i>	For Input 1: Enable—HDCP support is dictated by the display Disabled—HDCP encrypted content is not passed
3	<i>HDCP Mode input 2 Button</i>	For input 2: Enable—HDCP support is dictated by the display Disabled—HDCP encrypted content is not passed
4	<i>Audio de-embedding Indicator</i>	Click enable to de-embed the digital audio
5	<i>Set Button for 5V control upon signal loss, (see item 1)</i>	Enter the delay in seconds or use the increment/decrement buttons, then press Set to save the value

8.4 The Output Settings Page

The Output Settings page allows you to custom label the output buttons individually.

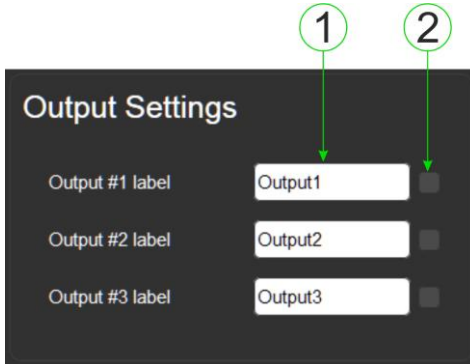

Figure 16: The Output Settings Page

#	Item	Description
1	Output Label	Enter the name required for each output
2	Save Button	Click to save the current label

Note: Performing a factory reset returns the labels to their default values.

8.5 The EDID Management Page

The EDID page lets you copy EDID data to an input from any of the following:

- Output
- Input
- EDID data file

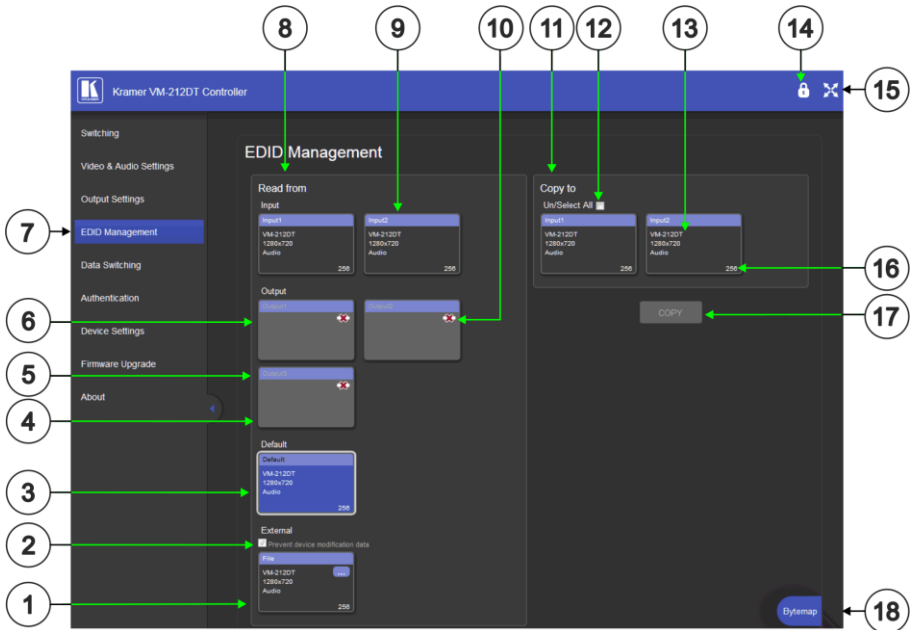

Figure 17: The EDID Management Page

Note: The display is not updated automatically when the status of an EDID changes on the device caused by outputs being exchanged. Click Refresh to update the display, (see [item 11](#) in the following table).

#	Item	Description
1	File Selector	Click to browse saved EDID files on the computer
2	Prevent Modification Checkbox	Click to prevent modification of data
3	Default EDID Button	Click to read the default EDID

#	Item	Description
4	<i>Output</i> Buttons 1 and 2	2 buttons to select the output (highlighted when selected)
5	Connection Indicator	Lights green when connected, grey when off
6	EDID Source Information	Device model, resolution, if audio connected
7	Web Page Selector	Click to show the desired Web page
8	<i>Read From</i> Section	From this section select the required EDID source to read from
9	Input Buttons (1-2)	Click to display the 2 input buttons for input selection, and port and signal identification
10	Output Connection Status	Shows whether output is connected or not
11	<i>Copy To</i> Section	From this section select the required EDID destination to which to copy
12	<i>Un/Select All</i> Checkbox	Check to select or unselect copying EDID to all inputs
13	EDID Information	Device model, resolution, if audio connected
14	Security Icon	Open lock indicates security not active, closed lock indicates active security (set security on the Authentication tab)
15	Full Screen Icon	Click to toggle full screen on/off
16	Audio Bitrate	Indicates the audio bitrate on the input or output
17	<i>Copy</i> Button	Click to copy the EDID from the selected source to the selected input
18	<i>Bytemap</i> Button	Click to open a window showing the selected EDID raw information

Note: The display is not updated automatically when the status of an EDID changes on the device due to outputs being exchanged. Click Refresh to update the display.

To copy EDID data from an Output or Input to one or more inputs:

1. Click the source button from which to copy the EDID (Output or Input).
The button changes color and the EDID summary information reflects the EDID data.
2. Click one or more destination Inputs, or select all Inputs by checking the Inputs check-box.
All selected Input buttons change color and the EDID summary information reflects the Input selection(s).

3. Click the Copy button.
The “EDID was copied” success message is displayed and the EDID data are copied to the selected Input(s).
4. Click OK.

To copy EDID data to an Input from an EDID data file:

1. Click the source Browse button.
The Windows Browser opens.
2. Browse to the required file.
3. Select the required file and click Open.
The EDID summary information reflects the selection.
4. Click one or more destination Inputs, or select all Inputs by checking the Inputs check-box.
All selected Input buttons change color and the EDID summary information reflects the Input selection(s).
5. Click the Copy button.
The “EDID was copied” success message is displayed and the EDID data are copied to the selected Input(s).
6. Click OK.

8.6 The Data Switching Page

The Data Switching page lets you route the RS-232 and IR inputs and outputs.

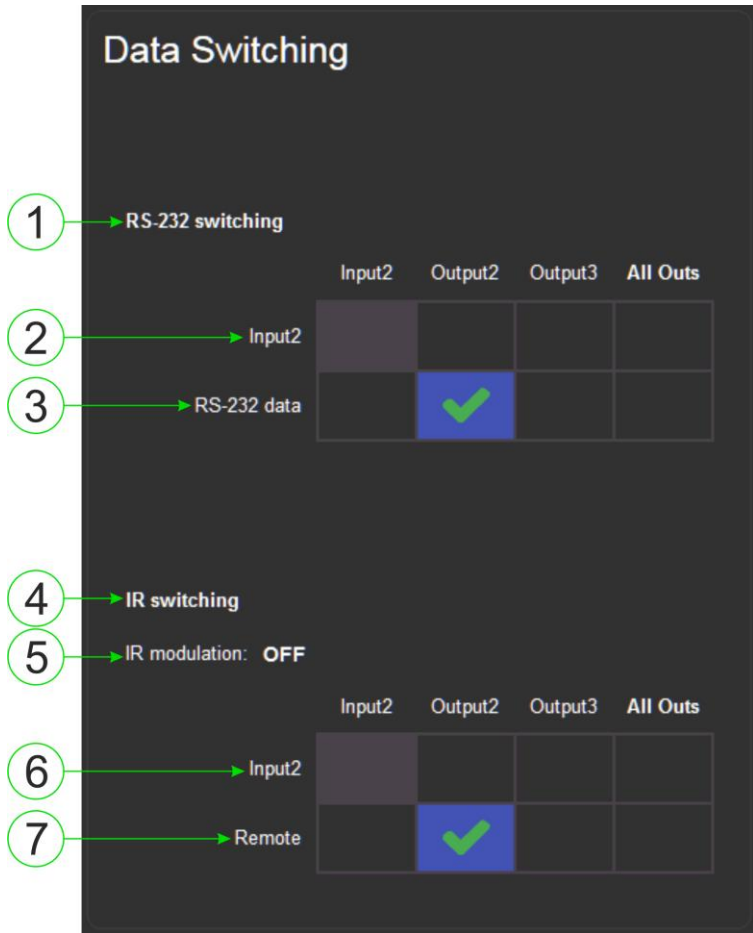

Figure 18: The Data Switching Page

#	Item	Description
1		
2	RS-232 Switching area	<i>Input 2</i> selection row
3		<i>RS-232 data</i> selection row
		Click a box to enable the routing of RS-232 data from Input 2 to the selected output(s)
		Click a box to enable the routing of RS-232 data from the RS-232 Data port to the selected output(s)

#	Item	Description	
4			
5	IR Switching area	<i>IR modulation</i> indicator	Indicates whether IR modulation is enabled or disabled
6		<i>Input 2</i> selection row	Click a box to enable the routing of IR data from Input 2 to the selected output(s)
7		<i>Remote</i> IR selection row	Click a box to enable the routing of IR data from the IR sensor on the front panel to the selected output(s)

RS-232 Switching Example

In the example configuration shown in [Figure 19](#) RS-232 data is routed from the RS-232 Data 3-pin terminal block to the HDBT Output 3.

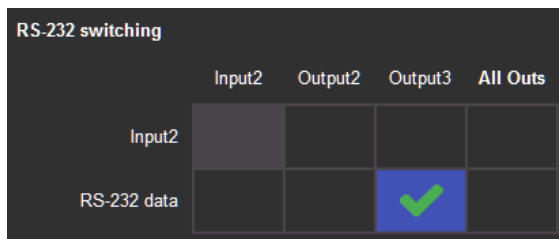

Figure 19: RS-232 Switching Example

IR Switching Example

In the example configuration shown in [Figure 20](#) IR data is routed from the IR sensor on the front panel and the IR 3.5mm mini jack on the rear panel to all outputs, (HDBT Output 2, 3, 4, and 5).

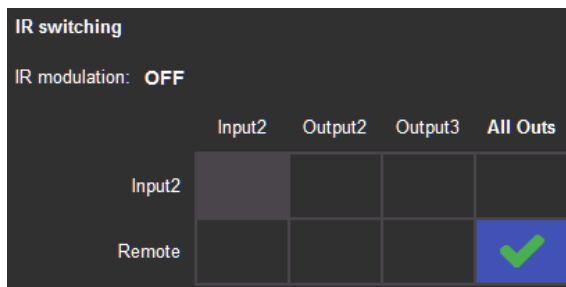

Figure 20: IR Switching Example

8.7 The Authentication Page

The Authentication page lets you assign or change logon authentication details.

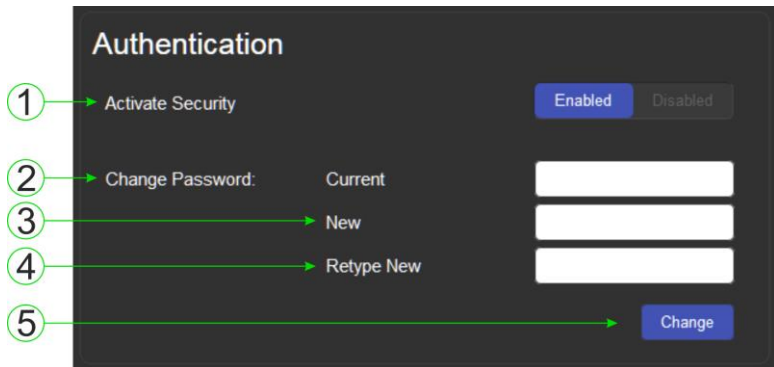

Figure 21: The Authentication Page

#	Item	Description
1	<i>Activate Security</i> Button	Click to enable/disable security settings. When enabled, the valid username and password must be provided to allow Web page access` 1234
2	<i>Current</i> Password box	Enter the current password
3	<i>New</i> Password box	Enter the new password, (up to 15 printable ASCII characters with no spaces)
4	<i>Retype New</i> Password box	Retype the new password
5	<i>CHANGE</i> button	Click CHANGE to save the new authentication details

Note: If the Authentication page is left open for more than five minutes additional windows may open. After entering your logon credentials, close the other windows.

8.8 The Device Settings Page

The Device Settings page lets you view and/or modify the device settings, for example, the device name and IP address.



Figure 22: The Device Settings Page

#	Item	Description
1	<i>Device Settings Section</i>	Displays information regarding the device, (model, firmware version, and serial number)
2	<i>Unit name</i>	The DNS name of the device. To set a new name, enter the new alphanumeric name and click Set. (For restrictions regarding the name, see Section 10.2)
3	<i>DHCP Buttons</i>	Click to turn DHCP on and off
4	<i>IP address</i>	The IP address of the device. To set a new IP address, enter the new valid IP address and click Set
5	<i>Mask address</i>	The network mask of the device. To set a new mask, enter the new valid mask and click Set
6	<i>Gateway address</i>	The network gateway for the device. To set a new network gateway, enter the new valid gateway and click Set
7	<i>Set IP Parameter Changes Button</i>	Click to save changes made any of the IP parameters
8	<i>Mac Address</i>	Displays the MAC address of the device
9	<i>UDP Port</i>	The UDP port number of the device. To set a new UDP port number, enter the new valid port number or use the spin controls and click Set
10	<i>Save Configuration Button</i>	Click to save the current configuration as a preset
11	<i>Load Configuration Button</i>	Click to load a previously saved configuration
12	<i>Factory Reset Button</i>	Click to reset the device to factory default parameters. After the success message is displayed, power cycle the device
13	<i>Set Name Button</i>	Click to save changes to the device name
14	<i>Set UDP Port Number Button</i>	Click to save changes to the UDP port number

Note: When changing either the DHCP mode or the static IP address of the device, the warning shown in [Figure 23](#) appears because communication will be lost with the device until you enter the new address in your browser.

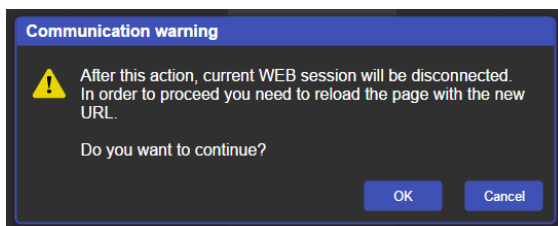

Figure 23: The IP Address Changes Popup Warning

8.8.1 The Load/Save Configuration Facility

The Upload/Save Configuration facility lets you retrieve and save a configuration.

To load a configuration:

1. Click the Load button.
The Load browser window appears.
2. Browse to the required file and press Open.
The configuration is retrieved and the success message is displayed.

To save the current configuration:

1. Click the Save button.
The Save Configuration success message is displayed.
2. Do either of the following:
 - Click Download to either open the file or save it to the required location
—OR—
 - Click OK to complete the procedure

Note: When saving the configuration using Internet Explorer 11 press CTRL+S.

To reset the VM-212DT to factory default parameters:

1. Click the Factory reset button.
The confirmation message shown in [Figure 24](#) is displayed.

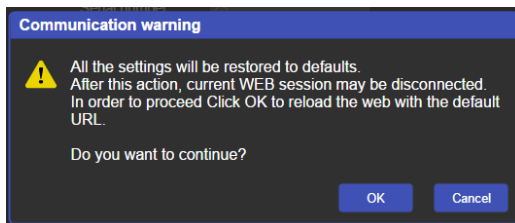

Figure 24: The Factory Reset Popup Warning

2. Click OK to continue or Cancel to exit the procedure.

3. Click OK.
The progress message is displayed.
On completion, the success message is displayed.
4. Click OK.

8.9 The Firmware Upgrade Page

The Firmware Upgrade page lets you upgrade the firmware of the device.

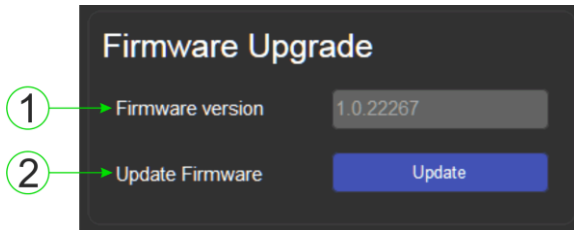

Figure 25: The Firmware Upgrade Window

#	Item	Description
1	<i>Firmware Version</i>	Displays the current firmware version
2	<i>Update Firmware Button</i>	Click to start the upgrade process

To upgrade the firmware:

1. Click the Update button.
The file browser opens.
2. Browse to the required file.
3. Select the required file and click Open.
The firmware file name is displayed in the Firmware Upgrade page.
4. Click Start Upgrade.
The firmware file is loaded and the warning message shown in [Figure 26](#) appears.

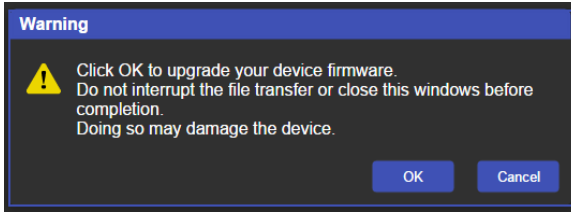

Figure 26: The Firmware Upgrade Warning Popup

5. Click OK to continue or Cancel to exit the procedure.
6. After clicking OK, the progress message shown in [Figure 27](#) appears.

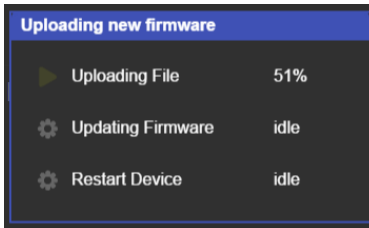

Figure 27: The Firmware Upgrade Process Popup



Do not interrupt the process or the **VM-212DT** may be damaged.

7. When the process is complete reboot the device.
The firmware is upgraded.

8.10 The About Us Page

The **VM-212DT** About Us page displays the Web page version and Kramer Electronics Ltd company details.



Figure 28: The About Us Page

9 Configuring the VM-212DT

9.1 Setting the DIP-switch

A switch that is down is on; a switch that is up is off. By default, all the switches are up (off).

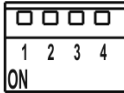

Figure 29: The Configuration DIP-switch

#	Feature	DIP-switch
1	IR modulation selection	Off—Disable IR modulation (up, default) On—Enable IR modulation (down)
2	Extra range	Off—Disable extra range (up, default) On—Enable extra range (down)
3	Compressed audio/ Audio de-embedding	Off—De-embed audio (up, default) On—Enable compressed audio (down)
4	Reserved	

Some devices require that the IR signal be specifically modulated or unmodulated. If there is a problem with the IR signal not being transmitted all the way from the IR transmitter to the final IR receiver, try setting the modulation on.

9.2 Performing a Factory Reset

To perform a factory reset of the VM-212DT:

1. Turn off the device.
2. Press and hold the Reset button on the rear of the device.
3. Turn on the device and keep the Reset button depressed for a few seconds.
4. Release the button.

The parameters are reset.

You can also perform a factory reset of the device by using the Web pages, (see [Section 8.8](#)) or by sending a Protocol 3000 command, (see [Section 9.2](#)). To implement the change, the device must be turned off and on again.

10 Technical Specifications

INPUTS:	1 HDMI connector 1 HDBT twisted pair on an RJ-45 connector
OUTPUTS:	1 HDMI connector 2 HDBT twisted pair on RJ-45 connectors
MAX. DATA RATE:	10.2Gbps (3.4Gbps per graphic channel, HDMI)
COMPLIANCE WITH HDMI STANDARDS:	Supports HDMI and HDCP
CONTROLS:	Input select button, EDID select button, panel lock button, RS-232, local and remote IR controls
INDICATOR LEDs:	IR communication, Power, IN 1 HDMI, IN 2 HDBT, OUTPUT 1 and 2, EDID TYPE Default, External, Output
POWER CONSUMPTION:	100-240V AC 50/60Hz 16VA
OPERATING TEMPERATURE:	0° to +40°C (32° to 104°F)
STORAGE TEMPERATURE:	-40° to +70°C (-40° to 158°F)
HUMIDITY:	10% to 90%, RHL non-condensing
COOLING:	Forced air, fan
ENCLOSURE TYPE:	Aluminium
RACK MOUNT:	With included rack "ears"
DIMENSIONS:	43.64cm x 18.3cm x 4.36cm, W, D, H (19" x 1U)
PRODUCT WEIGHT:	1.56kg (3.44lbs) approx.
SHIPPING WEIGHT:	2.7kg (5.95lbs) approx.
VIBRATION:	ISTA 1A in carton (International Safe Transit Association)
SAFETY REGULATORY COMPLIANCE:	CE
ENVIRONMENTAL REGULATORY COMPLIANCE:	Complies with appropriate requirements of RoHs and WEEE
INCLUDED ACCESSORIES:	Power cord Rack "ears"
Specifications are subject to change without notice at http://www.kramerelectronics.com	

10.1 Default IP Parameters

Parameter	Values	Default
Device Name	Any alphanumeric string up to 14 chars (can include hyphen, but not at the beginning or end)	KRAMER_
DHCP	ON/OFF	OFF
IP Address	Any valid IP address	192.168.1.39
Mask	Any valid network mask	255.255.0.0
Gateway	Any valid gateway address	192.168.0.1
TCP Port	0 to 65535	5000
UDP Port	0 to 65535	50000

10.2 Default Logon Credentials

Parameter	Values
Name	Admin
Password	Admin

10.3 Supported PC Web Browsers

Platform	Version
Windows 7 and higher	Internet Explorer (32/64 bit) version 10 Firefox version 30 Chrome version 35
Mac	Firefox version 30 Chrome version 35 Safari version 7 Note: Minimum browser window size 1024 x 768

11 Default EDID

Each input on the **VM-212DT** is loaded with a factory default EDID.

Monitor

Model name..... VM-212DT
Manufacturer..... KMR
Plug and Play ID..... KMR1200
Serial number..... 295-883450100
Manufacture date..... 2014, ISO week 255
Filter driver..... None

EDID revision..... 1.4
Input signal type..... Digital
Color bit depth..... Undefined
Color encoding formats... RGB 4:4:4
Screen size..... 520 x 320 mm (24.0 in)
Power management..... Standby, Suspend, Active off/sleep
Extension blocs..... 1 (CEA-EXT)

DDC/CI..... n/a

Color characteristics

Default color space..... Non-sRGB
Display gamma..... 2.20
Red chromaticity..... Rx 0.674 - Ry 0.319
Green chromaticity..... Gx 0.188 - Gy 0.706
Blue chromaticity..... Bx 0.148 - By 0.064
White point (default).... Wx 0.313 - Wy 0.329
Additional descriptors... None

Timing characteristics

Horizontal scan range... 30-83kHz
Vertical scan range..... 56-76Hz
Video bandwidth..... 170MHz
CVT standard..... Not supported
GTF standard..... Not supported
Additional descriptors... None
Preferred timing..... Yes
Native/preferred timing.. 1280x720p at 60Hz (16:10)
Modeline..... "1280x720" 74.250 1280 1390 1430 1650 720 725 730 750 +hsync +vsync

Standard timings supported

720 x 400p at 70Hz - IBM VGA
720 x 400p at 88Hz - IBM XGA2
640 x 480p at 60Hz - IBM VGA
640 x 480p at 67Hz - Apple Mac II
640 x 480p at 72Hz - VESA
640 x 480p at 75Hz - VESA
800 x 600p at 56Hz - VESA
800 x 600p at 60Hz - VESA
800 x 600p at 72Hz - VESA
800 x 600p at 75Hz - VESA
832 x 624p at 75Hz - Apple Mac II
1024 x 768i at 87Hz - IBM
1024 x 768p at 60Hz - VESA
1024 x 768p at 70Hz - VESA
1024 x 768p at 75Hz - VESA
1280 x 1024p at 75Hz - VESA
1152 x 870p at 75Hz - Apple Mac II
1280 x 1024p at 75Hz - VESA STD
1280 x 1024p at 85Hz - VESA STD
1600 x 1200p at 60Hz - VESA STD
1024 x 768p at 85Hz - VESA STD
800 x 600p at 85Hz - VESA STD
640 x 480p at 85Hz - VESA STD
1152 x 864p at 70Hz - VESA STD

12 Protocol 3000

The can be operated using serial commands from a PC, remote controller or touch screen using the Kramer Protocol 3000.

This section describes:

- Kramer Protocol 3000 syntax (see [Section 12.1](#))
- Kramer Protocol 3000 commands (see [Section 12.2](#))

12.1 Kramer Protocol 3000 Syntax

12.1.1 Host Message Format

Start	Address (optional)	Body	Delimiter
#	<i>Device_id@</i>	Message	CR

12.1.1.1 Simple Command

Command string with only one command without addressing:

Start	Body	Delimiter
#	Command SP <i>Parameter_1,Parameter_2,...</i>	CR

12.1.1.2 Command String

Formal syntax with commands concatenation and addressing:

Start	Address	Body	Delimiter
#	<i>Device_id@</i>	Command_1 <i>Parameter1_1,Parameter1_2,...</i> Command_2 <i>Parameter2_1,Parameter2_2,...</i> Command_3 <i>Parameter3_1,Parameter3_2,...</i> ...	CR

12.1.2 Device Message Format

Start	Address (optional)	Body	Delimiter
~	<i>Device_id@</i>	Message	CR LF

12.1.2.1 Device Long Response

Echoing command:

Start	Address (optional)	Body	Delimiter
~	Device_id@	Command SP [Param1 ,Param2 ...] result	CR LF

CR = Carriage return (ASCII 13 = 0x0D)

LF = Line feed (ASCII 10 = 0x0A)

SP = Space (ASCII 32 = 0x20)

12.1.3 Command Terms

Command

A sequence of ASCII letters ('A'-'Z', 'a'-'z' and '-').

Command and parameters must be separated by at least one space.

Parameters

A sequence of alphanumeric ASCII characters ('0'-'9', 'A'-'Z', 'a'-'z' and some special characters for specific commands). Parameters are separated by commas.

Message string

Every command entered as part of a message string begins with a **message starting character** and ends with a **message closing character**.

Note: A string can contain more than one command. Commands are separated by a pipe ('|') character.

Message starting character

'#' – For host command/query

'~' – For device response

Device address (Optional, for K-NET)

K-NET Device ID followed by '@'

Query sign

'?' follows some commands to define a query request.

Message closing character

CR – For host messages; carriage return (ASCII 13)

CRLF – For device messages; carriage return (ASCII 13) + line-feed (ASCII 10)

Command chain separator character

When a message string contains more than one command, a pipe ('|') character separates each command.

Spaces between parameters or command terms are ignored.

12.1.4 Entering Commands

You can directly enter all commands using a terminal with ASCII communications software, such as HyperTerminal, Hercules, etc. Connect the terminal to the serial or Ethernet port on the Kramer device. To enter **CR** press the Enter key. (**LF** is also sent but is ignored by command parser).

For commands sent from some non-Kramer controllers like Crestron, some characters require special coding (such as, /X##). Refer to the controller manual.

12.1.5 Command Forms

Some commands have short name syntax in addition to long name syntax to allow faster typing. The response is always in long syntax.

12.1.6 Chaining Commands

Multiple commands can be chained in the same string. Each command is delimited by a pipe character ("|"). When chaining commands, enter the **message starting character** and the **message closing character** only once, at the beginning of the string and at the end.

Commands in the string do not execute until the closing character is entered.

A separate response is sent for every command in the chain.

12.1.7 Maximum String Length

64 characters

12.2 Kramer Protocol 3000 Commands

Command	Description
#	Protocol handshaking
AUD-LVL	Set/get audio level in specific amplifier stage
AV-SW-TIMEOUT	Set/get video auto-switch timeout
BUILD-DATE?	Read device build date
CPEDID	Copy EDID data from the output to the input
DIR	List files in device
DISPLAY?	Get output HPD status
DPSW-STATUS?	Get the DIP-switch status
ETH-PORT	Set/get Ethernet port protocol
FACTORY	Reset to factory default configuration
FPGA-VER?	Get current FPGA version
FS-FREE?	Get file system free space
GEDID	Read EDID data
GET	Get file
HDCP-MOD	Set/get HDCP mode
HDCP-STAT?	Get HDCP signal status
HELP?	Get command list
LDEDID	Write EDID data to input
LOGIN	Set/get protocol permission
LOGOUT	Cancel current permission level
MODEL?	Read device model
MUTE	Set/get audio mute
NAME	Set/get machine (DNS) name
NAME-RST	Reset machine name to factory default (DNS)
NET-DHCP	Set/get DHCP mode
NET-GATE	Set/get gateway IP
NET-IP	Set/get IP address
NET-MAC?	Get MAC address
NET-MASK	Set/get subnet mask
PASS	Set/get Password
PING	Sends ICMP ECHO
PROT-VER?	Get device protocol version
RESET	Reset device
ROUTE	Set/get layer routing
SECUR	Start/Stop Security
SIGNAL?	Get input signal lock status
SN?	Read device serial number
VERSION?	Read device firmware version

Command - #		Command Type - System-mandatory	
Command Name		Permission	Transparency
Set:	#	End User	Public
Get:	-	-	-
Description		Syntax	
Set:	Protocol handshaking	# <input type="text"/> _ <input type="text"/>	
Get:	-	-	
Response			
~ <input type="text"/> @ <input type="text"/> _ <input type="text"/> OK <input type="text"/> _ <input type="text"/> LF			
Parameters			
Response Triggers			
Notes			
Use to validate the Protocol 3000 connection and get the machine number			

Command - AUD-LVL		Command Type - Audio	
Command Name		Permission	Transparency
Set:	AUD-LVL	End User	Public
Get:	AUD-LVL?	End User	Public
Description		Syntax	
Set:	Set audio level in specific amplifier stage	#AUD-LVL <input type="text"/> _ <input type="text"/> stage, channel, volume <input type="text"/>	
Get:	Get audio level in specific amplifier stage	#AUD-LVL? <input type="text"/> _ <input type="text"/> stage, channe <input type="text"/>	
Response			
~ <input type="text"/> @AUD-LVL <input type="text"/> _ <input type="text"/> stage, channel, volume <input type="text"/> _ <input type="text"/> LF			
Parameters			
<i>stage</i> - 'IN, 'OUT' <i>channel</i> - input or output number <i>volume</i> - audio parameter in Kramer units, minus sign precedes negative values. ++ increase current value, -- decrease current value			
Response Triggers			
Notes			

Command - AV-SW-TIMEOUT		Command Type - System	
Command Name		Permission	Transparency
Set:	AV-SW-TIMEOUT	End User	Public
Get:	AV-SW-TIMEOUT?	End User	Public
Description		Syntax	
Set:	Set auto switching timeout	#AV-SW-TIMEOUT _[SP] action,time_out _[CR]	
Get:	Get auto switching timeout	#AV-SW-TIMEOUT? _[SP] action _[CR]	
Response			
~ _[hh] @AV-SW-TIMEOUT _[SP] action,time_out _[CR]			
Parameters			
<i>action</i>			
<i>timeout</i> - timeout in seconds			
Response Triggers			
Notes			

Command - BUILD-DATE		Command Type - System-mandatory	
Command Name		Permission	Transparency
Set:	-	-	-
Get:	BUILD-DATE?	End User	Public
Description		Syntax	
Set:	-	-	
Get:	Get device build date	#BUILD-DATE _[CR]	
Response			
~ _[hh] @BUILD-DATE _[SP] date _[SP] time _[CR] _[LF]			
Parameters			
<i>date</i> - Format: YYYY/MM/DD where YYYY = Year, MM = Month, DD = Day			
<i>time</i> - Format: hh:mm:ss where hh = hours, mm = minutes, ss = seconds			
Response Triggers			
Notes			

Command - CPEDID		Command Type - System	
Command Name		Permission	Transparency
Set:	CPEDID	End User	Public
Get:	-	-	-
Description		Syntax	
Set:	Copy EDID data from the output to the input EEPROM	#CPEDID _{SP} src_type, src_id, dst_type, dest_bitmap _{CR}	
Get:	-	-	
Response			
~nn@CPEDID _{SP} src_stg, src_id, dst_type, dest_bitmap _{CR LF}			
Parameters			
<p>src_type - EDID source type (usually output)</p> <p>src_id - number of chosen source stage (1.. max number of inputs/outputs)</p> <p>dst_type - EDID destination type (usually input) (see Section 12.2.4)</p> <p>dest_bitmap - bitmap representing destination IDs. Format: XXXX...X, where X is hex digit. The binary form of every hex digit represents corresponding destinations. Setting '1' says that EDID data has to be copied to this destination</p>			
Response Triggers			
Response is sent to the com port from which the Set was received (before execution)			
Notes			
<p>Destination bitmap size depends on device properties (for 64 inputs it is a 64-bit word)</p> <p>Example: bitmap 0x0013 means inputs 1,2 and 5 are loaded with the new EDID</p>			

Command - DIR		Command Type - File System	
Command Name		Permission	Transparency
Set:	DIR	Administrator	Public
Get:	-	-	-
Description		Syntax	
Set:	List files in device	#DIR <input type="checkbox"/>	
Get:	-	-	
Response			
Multi Line:			
~ <input type="checkbox"/> <input type="checkbox"/> @DIR <input type="checkbox"/> <input type="checkbox"/>			
file_name <input type="checkbox"/> file_size <input type="checkbox"/> bytes. <input type="checkbox"/> ID: <input type="checkbox"/> file_id <input type="checkbox"/>			
<input type="checkbox"/> free_size <input type="checkbox"/> bytes. <input type="checkbox"/>			
Parameters			
file_name - name of file			
file_size - file size in bytes. A file can take more space on device memory			
file_id - internal ID for file in file system			
free_size - free space in bytes in device file system			
Response Triggers			
Notes			

Command – DPSW-STATUS?		Command Type – System	
Command Name		Permission	Transparency
Set:	-	-	-
Get:	DPSW-STATUS?	End User	Public
Description		Syntax	
Set:	-	-	
Get :	Get the DIP-switch state	# DPSW-STATUS? <input type="checkbox"/> dp_sw_id <input type="checkbox"/>	
Response			
~ <input type="checkbox"/> <input type="checkbox"/> @ DPSW-STATUS? <input type="checkbox"/> dp_sw_id, status <input type="checkbox"/> <input type="checkbox"/>			
Parameters			
dp_sw_id - 1....num of DIP switches			
status - 0: up 1: down			
Response Triggers			
Notes			

Command - DISPLAY?		Command Type - System	
Command Name		Permission	Transparency
Set:	-	-	-
Get	DISPLAY?	End User	Public
Description		Syntax	
Set:	-	-	
Get:	Get output HPD status	# DISPLAY? <input type="checkbox"/> <i>out_id</i> <input type="checkbox"/>	
Response			
~ <input type="checkbox"/> @ DISPLAY <input type="checkbox"/> <i>out_id,status</i> <input type="checkbox"/> <input type="checkbox"/>			
Parameters			
<i>out_id</i> - output number			
<i>status</i> - HPD status according to signal validation			
Response Triggers			
After execution, response is sent to the com port from which the Get was received			
Response is sent after every change in output HPD status ON to OFF			
Response is sent after every change in output HPD status OFF to ON and ALL parameters (new EDID, etc.) are stable and valid			
Notes			

Command - ETH-PORT		Command Type - Communication	
Command Name		Permission	Transparency
Set:	ETH-PORT	Administrator	Public
Get:	ETH-PORT?	End User	Public
Description		Syntax	
Set:	Set Ethernet port protocol	# ETH-PORT _[SP] <i>portType</i> , <i>ETHPort</i> _[CR]	
Get:	Get Ethernet port protocol	# ETH-PORT? _[SP] <i>portType</i> _[CR]	
Response			
~ nn @ ETH-PORT _[SP] <i>portType</i> , <i>ETHPort</i> _[CR LF]			
Parameters			
<i>portType</i> - TCP/UDP			
<i>ETHPort</i> - TCP/UDP port number			
Response Triggers			
Notes			

Command - FACTORY		Command Type - System-mandatory	
Command Name		Permission	Transparency
Set:	FACTORY	End User	Public
Get:	-	-	-
Description		Syntax	
Set:	Reset device to factory default configuration	# FACTORY _[CR]	
Get:	-	-	
Response			
~ nn @ FACTORY _[SP] OK _[CR LF]			
Parameters			
Response Triggers			
Notes			
This command deletes all user data from the device. The deletion can take some time. Your device may require powering off and powering on for the changes to take effect.			

Command - FPGA-VER?		Command Type - System	
Command Name		Permission	Transparency
Set:	-	-	-
Get:	FPGA-VER?	End User	Public
Description		Syntax	
Set:	-	-	
Get:	Get current FPGA version	# FPGA-VER? _[SP] _[C] _[CR]	
Response			
~ _[n] @ FPGA-VER _[SP] _[id] , <i>expected_ver</i> , <i>actual_ver</i> _[CR] _[LF]			
Parameters			
<i>id</i> - FPGA id <i>expected_ver</i> - expected FPGA version for current firmware <i>actual_ver</i> - actual FPGA version			
Response Triggers			
Notes			

Command - FS-FREE?		Command Type - File System	
Command Name		Permission	Transparency
Set:	-	-	-
Get:	FS-FREE?	Administrator	Public
Description		Syntax	
Set:	-	-	
Get:	Get file system free space	# FS-FREE? _[CR]	
Response			
~ _[n] @ FS_FREE _[SP] _[free_size] _[CR] _[LF]			
Parameters			
<i>free_size</i> - free size in device file system in bytes			
Response Triggers			
Notes			

Command - GEDID		Command Type - System	
Command Name		Permission	Transparency
Set:	GEDID	Administrator	Public
Get:	GEDID?	End User	Public
Description		Syntax	
Set:	Set EDID data from device	#GEDID _{SP} stage, stage_id _{CR}	
Get:	Get EDID support on certain input/output	#GEDID? _{SP} stage, stage_id _{CR}	
Response			
Set:			
Multi-line response:			
~nn@GEDID _{SP} stage,stage_id,size _{CR LF}			
EDID_data _{CR LF}			
~nn@GEDID _{SP} stage,stage_id _{SP} OK _{CR LF}			
Get:			
~nn@GEDID _{SP} stage,stage_id,size _{CR LF}			
Parameters			
stage - input/output			
stage_id - number of chosen stage (1.. max number of inputs/outputs)			
size - EDID data size. For Set, size of data to be sent from device, for Get, 0 means no EDID support			
Response Triggers			
Response is sent to the com port from which the Set (before execution) / Get command was received			
Notes			
For Get, size=0 means EDID is not supported			
For old devices that do not support this command, ~nn@ ERR 002 _{CR LF} is received			

Command - GET		Command Type - File System	
Command Name		Permission	Transparency
Set:	-	-	-
Get:	GET	Administrator	Public
Description		Syntax	
Set:	-	-	
Get:	Get file	#GET _{SP} file_name _{CR}	
Response			
Multi-line:			
~ _{nl} @GET _{SP} file_name, file_size _{SP} READY _{CR LF} contents			
~ _{nl} @GET _{SP} file_name _{SP} OK _{CR LF}			
Parameters			
file_name - name of file to get contents contents - byte stream of file contents file_size - size of file (device sends it in response to give user a chance to get ready)			
Response Triggers			
Notes			

Command - HDCP-MOD		Command Type - System	
Command Name		Permission	Transparency
Set:	HDCP-MOD	Administrator	Public
Get:	HDCP-MOD?	End User	Public
Description		Syntax	
Set:	Set HDCP mode	#HDCP-MOD _{SP} inp_id,mode _{CR}	
Get:	Get HDCP mode	#HDCP-MOD? _{SP} stage_id _{CR}	
Response			
Set / Get: ~ _{NN} @HDCP-MOD _{SP} stage_id,mode _{CR LF}			
Parameters			
inp_id - input number (1.. max number of inputs) mode - HDCP mode			
Response Triggers			
Response is sent to the com port from which the Set (before execution) / Get command was received Response is sent to all com ports after execution if HDCP-MOD was set by any other external control device (button press, device menu and similar) or HDCP mode changed			
Notes			
Set HDCP working mode on the device input: HDCP supported - HDCP_ON [default] HDCP not supported - HDCP OFF HDCP support changes following detected sink - MIRROR OUTPUT			

Command - HDCP-STAT		Command Type - System	
Command Name		Permission	Transparency
Set:	-	-	-
Get:	HDCP-STAT?	End User	Public
Description		Syntax	
Set:	None	-	
Get:	Get HDCP signal status	#HDCP-STAT? _{SP} stage,stage_id _{CR}	
Response			
Set / Get: ~ <u>nn</u> @HDCP-STAT _{SP} stage,stage_id,mode _{CR LF}			
Parameters			
<i>stage</i> – input/output <i>stage_id</i> - number of chosen stage (1.. max number of inputs/outputs) <i>actual_status</i> - signal encryption status - valid values ON/OFF			
Response Triggers			
Response is sent to the com port from which the Set (before execution) / Get command was received Response is sent to all com ports after execution if HDCP-STAT was set by any other external control device (button press, device menu and similar) or HDCP mode changed			
Notes			
On output – sink status On input – signal status			

Command - HELP		Command Type - System-mandatory	
Command Name		Permission	Transparency
Set:	-	-	-
Get:	HELP	End User	Public
Description		Syntax	
Set:	-	-	
Get:	Get command list or help for specific command	2 options: 1. #HELP _{CR} 2. #HELP _{SP} command_name _{CR}	
Response			
1. Multi-line: ~ _{nn} @Device available protocol 3000 commands: _{CR LF} command _{SP} command... _{CR LF}			
To get help for command use: HELP (COMMAND_NAME)_{CR LF}			
2. Multi-line: ~ _{nn} @HELP _{SP} command: _{CR LF} description _{CR LF} USAGE : usage _{CR LF}			
Parameters			
Response Triggers			
Notes			

Command - LDEDID		Command Type - System	
Command Name		Permission	Transparency
Set:	LDEDID	End User	Public
Get:	-	-	-
Description		Syntax	
Set:	Write EDID data from external application to device	Multi-step syntax (see following steps)	
Get:	None	None	
Communication Steps (Command and Response)			
<p>Step 1: #LDEDID_{SP}dst_type, dest_bitmask, size, safe_mode_{CR}</p> <p>Response 1: ~nn@LDEDID_{SP}dst_type, dest_bitmask, size, safe_mode_{SP}READY_{CR LF} or ~nn@LDEDID_{SP}ERRnn_{CR LF}</p> <p>Step 2: If ready was received, send EDID_DATA</p> <p>Response 2: ~nn@LDEDID_{SP}dst_type, dest_bitmask, size, safe_mode_{SP}OK_{CR LF} or ~nn@LDEDID_{SP}ERRnn_{CR LF}</p>			
Parameters			
<p>dst_type - EDID destination type (usually input)</p> <p>dest_bitmask - bitmap representing destination IDs. Format: 0x*****, where * is ASCII presentation of hex digit. The binary presentation of this number is a bit mask for destinations. Setting '1' means EDID data has to be copied to this destination</p> <p>size - EDID data size</p> <p>safe_mode - 0 - Device accepts the EDID as is without trying to adjust 1 - Device tries to adjust the EDID</p> <p>EDID_DATA - data in protocol packets</p>			
Response Triggers			
Response is sent to the com port from which the Set (before execution)			
Notes			
<p>When the unit receives the LDEDID command it replies with READY and enters the special EDID packet wait mode. In this mode the unit can receive only packets and not regular protocol commands. If the unit does not receive correct packets for 30 seconds or is interrupted for more than 30 seconds before receiving all packets, it sends timeout error ~nn@LDEDID_{SP}ERR01_{CR LF} and returns to the regular protocol mode. If the unit received data that is not a correct packet, it sends the corresponding error and returns to the regular protocol mode.</p>			

Command - LOGIN		Command Type - Authentication	
Command Name		Permission	Transparency
Set:	LOGIN	Not Secure	Public
Get:	LOGIN?	Not Secure	Public
Description		Syntax	
Set:	Set protocol permission	# LOGIN _{SP} login_level,password _{CR}	
Get:	Get current protocol permission level	# LOGIN? _{CR}	
Response			
Set: ~nn@ LOGIN _{SP} login_level,password _{SP} OK _{CR LF}			
or			
~nn@ LOGIN _{SP} ERR _{SP} 004 _{CR LF} (if bad password entered)			
Get: ~nn@ LOGIN _{SP} login_level _{CR LF}			
Parameters			
<i>login_level</i> - level of permissions required (End User or Admin)			
<i>password</i> - predefined password (by PASS command). Default password is an empty string			
Response Triggers			
Notes			
For devices that support security, LOGIN allows to the user to run commands with an End User or Administrator permission level			
In each device, some connections can be logged in to different levels and some do not work with security at all			
Connection may logout after timeout			
The permission system works only if security is enabled with the "SECUR" command			

Command - LOGOUT		Command Type - Authentication	
Command Name		Permission	Transparency
Set:	LOGOUT	Not Secure	Public
Get:	-	-	-
Description		Syntax	
Set:	Cancel current permission level	#LOGOUT _{CR}	
Get:	-	-	
Response			
~nn@LOGOUT _{SP} ok _{CR LF}			
Parameters			
Response Triggers			
Notes			
Logs out from End User or Administrator permission levels to Not Secure			

Command - MODEL?		Command Type - System-mandatory	
Command Name		Permission	Transparency
Set:	-	-	-
Get:	MODEL?	End User	Public
Description		Syntax	
Set:	-	-	
Get:	Get device model	#MODEL? _{CR}	
Response			
~nn@MODEL _{SP} model_name _{CR LF}			
Parameters			
model_name - String of up to 19 printable ASCII chars			
Response Triggers			
Notes			

Command - MUTE		Command Type - Audio	
Command Name		Permission	Transparency
Set:	MUTE	End User	Public
Get:	MUTE?	End User	Public
Description		Syntax	
Set:	Set audio mute	# MUTE _[SP] channel,mute_mode _[CR]	
Get:	Get audio mute	# MUTE? _[SP] channel _[CR]	
Response			
~ nn @ MUTE _[SP] channel,mute_mode _[CR LF]			
Parameters			
channel - output number mute_mode - 0 or OFF / 1 or ON			
Response Triggers			
Notes			

Command - NAME		Command Type - System (Ethernet)	
Command Name		Permission	Transparency
Set:	NAME	Administrator	Public
Get:	NAME?	End User	Public
Description		Syntax	
Set:	Set machine (DNS) name	# NAME _[SP] machine_name _[CR]	
Get:	Get machine (DNS) name	# NAME? _[CR]	
Response			
Set: ~ nn @ NAME _[SP] machine_name _[CR LF]			
Get: ~ nn @ NAME? _[SP] machine_name _[CR LF]			
Parameters			
machine_name - String of up to 14 alpha-numeric chars (can include hyphen, not at the beginning or end)			
Response Triggers			
Notes			
The machine name is not the same as the model name. The machine name is used to identify a specific machine or a network in use (with DNS feature on)			

Command - NAME-RST		Command Type - System (Ethernet)	
Command Name		Permission	Transparency
Set:	NAME-RST	Administrator	Public
Get:	-	-	-
Description		Syntax	
Set:	Reset machine (DNS) name to factory default	# NAME-RST <input type="checkbox"/>	
Get:	-	-	
Response			
~ <input type="checkbox"/> @ NAME-RST <input type="checkbox"/> OK <input type="checkbox"/>			
Parameters			
Response Triggers			
Notes			
Factory default of machine (DNS) name is "KRAMER_" + 4 last digits of device serial number			

Command - NET-DHCP		Command Type - Communication	
Command Name		Permission	Transparency
Set:	NET-DHCP	Administrator	Public
Get:	NET-DHCP?	End User	Public
Description		Syntax	
Set:	Set DHCP mode	# NET-DHCP <input type="checkbox"/> mode <input type="checkbox"/>	
Get:	Get DHCP mode	# NET-DHCP? <input type="checkbox"/>	
Response			
~ <input type="checkbox"/> @ NET-DHCP <input type="checkbox"/> mode <input type="checkbox"/>			
Parameters			
<i>mode</i> - 0 - Do not use DHCP. Use the IP set by the factory or using the IP set command 1 - Try to use DHCP. If unavailable, use IP as above			
Response Triggers			
Notes			
Connecting Ethernet to devices with DHCP may take more time in some networks To connect with a randomly assigned IP by DHCP, specify the device DNS name (if available) using the command "NAME". You can also get an assigned IP by direct connection to USB or RS-232 protocol port if available For proper settings consult your network administrator			

Command - NET-GATE		Command Type - Communication	
Command Name		Permission	Transparency
Set:	NET-GATE	Administrator	Public
Get:	NET-GATE?	End User	Public
Description		Syntax	
Set:	Set gateway IP	#NET-GATE _{SP} ip_address _{CR}	
Get:	Get gateway IP	#NET-GATE? _{CR}	
Response			
- _{nl} @NET-GATE _{SP} ip_address _{CR LF}			
Parameters			
<i>ip_address</i> - format: xxx.xxx.xxx.xxx			
Response Triggers			
Notes			
A network gateway connects the device via another network and maybe over the Internet. Be careful of security problems. For proper settings consult your network administrator			

Command - NET-IP		Command Type - Communication	
Command Name		Permission	Transparency
Set:	NET-IP	Administrator	Public
Get:	NET-IP?	End User	Public
Description		Syntax	
Set:	Set IP address	#NET-IP _{SP} ip_address _{CR}	
Get:	Get IP address	#NET-IP? _{CR}	
Response			
- _{nl} @ NET-IP _{SP} ip_address _{CR LF}			
Parameters			
<i>ip_address</i> - format: xxx.xxx.xxx.xxx			
Response Triggers			
Notes			
For proper settings consult your network administrator			

Command - NET-MAC?		Command Type - Communication	
Command Name		Permission	Transparency
Set:	-	-	-
Get:	NET-MAC?	End User	Public
Description		Syntax	
Set:	-	-	
Get:	Get MAC address	# NET-MAC? _{CR}	
Response			
~ nn @ NET-MAC _{SP} <i>mac_address</i> _{CR LF}			
Parameters			
<i>mac_address</i> - Unique MAC address. Format: XX-XX-XX-XX-XX-XX where X is hex digit			
Response Triggers			
Notes			

Command - NET-MASK		Command Type - Communication	
Command Name		Permission	Transparency
Set:	NET-MASK	Administrator	Public
Get:	NET-MASK?	End User	Public
Description		Syntax	
Set:	Set subnet mask	# NET-MASK _{SP} <i>net_mask</i> _{CR}	
Get:	Get subnet mask	# NET-MASK? _{CR}	
Response			
~ nn @ NET-MASK _{SP} <i>net_mask</i> _{CR LF}			
Parameters			
<i>net_mask</i> - format: xxx.xxx.xxx.xxx			
Response Triggers			
The subnet mask limits the Ethernet connection within the local network For proper settings consult your network administrator			
Notes			

Command - PASS		Command Type - Authentication	
Command Name		Permission	Transparency
Set:	PASS	Administrator	Public
Get:	PASS?	Administrator	Public
Description		Syntax	
Set:	Set password for login level	# PASS _[SP] login_level, password _[CR]	
Get:	Get password for login level	# PASS? _[SP] login_level _[CR]	
Response			
~ _[n] @ PASS _[SP] login_level, password _[SP] OK _[CR LF]			
Parameters			
<i>login_level</i> - level of login to set (End User or Administrator).			
<i>password</i> - password for the <i>login_level</i> . Up to 15 printable ASCII chars			
Response Triggers			
Notes			
The default password is an empty string			

Command - PROT-VER?		Command Type - System-mandatory	
Command Name		Permission	Transparency
Set:	-	-	-
Get:	PROT-VER?	End User	Public
Description		Syntax	
Set:	-	-	
Get:	Get device protocol version	# PROT-VER? _[CR]	
Response			
~ _[n] @ PROT-VER _[SP] 3000:version _[CR LF]			
Parameters			
<i>Version</i> - XX.XX where X is a decimal digit			
Response Triggers			
Notes			

Command - RESET		Command Type - System-mandatory	
Command Name		Permission	Transparency
Set:	RESET	Administrator	Public
Get:	-	-	-
Description		Syntax	
Set:	Reset device	#RESET _{CR}	
Get:	-	-	
Response			
~h _{nl} @RESET _{SP} OK _{CR LF}			
Parameters			
Response Triggers			
Notes			
To avoid locking the port due to a USB bug in Windows, disconnect USB connections immediately after running this command. If the port was locked, disconnect and reconnect the cable to reopen the port.			

Command - ROUTE		Command Type - Routing	
Command Name		Permission	Transparency
Set:	ROUTE	End User	Public
Get:	ROUTE?	End User	Public
Description		Syntax	
Set:	Set layer routing	#ROUTE _{SP} layer, dest, src _{CR}	
Get:	Get layer routing	#ROUTE? _{SP} layer, dest _{CR}	
Response			
~ nn@ ROUTE _{SP} layer, dest, src _{CR LF}			
Parameters			
<i>layer</i> - see Section 12.2.6 <i>dest</i> - * - ALL x - disconnect, otherwise destination id <i>src</i> - source id			
Response Triggers			
Notes			
This command replaces all other routing commands The GET command identifies input switching on Step-in clients The SET command is for remote input switching on Step-in clients (essentially via by the Web)			

Command - SECUR		Command Type - Authentication	
Command Name		Permission	Transparency
Set:	SECUR	Administrator	Public
Get:	SECUR?	Not Secure	Public
Description		Syntax	
Set:	Start/stop security	# SECUR _[SP] security_mode _[CR]	
Get:	Get current security state	# SECUR? _[CR]	
Response			
Set:	~ _[n] @ SECUR _[SP] security_mode _[SP] OK _[CR LF]		
Get:	~ _[n] @ SECUR _[SP] security_mode _[CR LF]		
Parameters			
security_mode – 1/ON - enables security, 0/OFF - disables security			
Response Triggers			
Notes			
The permission system works only if security is enabled with the “SECUR” command			

Command - SIGNAL		Command Type - System	
Command Name		Permission	Transparency
Set:	-	-	-
Get	SIGNAL?	End User	Public
Description		Syntax	
Set:	-	-	
Get:	Get input signal lock status	# SIGNAL? _[SP] inp_id _[CR]	
Response			
~ _[n] @ SIGNAL _[SP] inp_id,status _[CR LF]			
Parameters			
inp_id - input number status - lock status according to signal validation			
Response Triggers			
After execution, a response is sent to the com port from which the Get was received Response is sent after every change in input signal status ON to OFF, or OFF to ON			
Notes			

Command - SN?		Command Type - System-mandatory	
Command Name		Permission	Transparency
Set:	-	-	-
Get:	SN?	End User	Public
Description		Syntax	
Set:	-	-	
Get:	Get device serial number	# SN? <input type="checkbox"/> <input type="checkbox"/>	
Response			
- <input type="checkbox"/> @ SN <input type="checkbox"/> <i>serial_number</i> <input type="checkbox"/> <input type="checkbox"/>			
Parameters			
<i>serial_number</i> - 11 decimal digits, factory assigned			
Response Triggers			
Notes			
For new products with 14 digit serial numbers, use only the last 11 digits			

Command - VERSION?		Command Type - System-mandatory	
Command Name		Permission	Transparency
Set:	-	-	-
Get:	VERSION?	End User	Public
Description		Syntax	
Set:	-	-	
Get:	Get firmware version number	# VERSION? <input type="checkbox"/> <input type="checkbox"/>	
Response			
- <input type="checkbox"/> @ VERSION <input type="checkbox"/> <i>firmware_version</i> <input type="checkbox"/> <input type="checkbox"/>			
Parameters			
<i>firmware_version</i> - XX.XX.XXXX where the digit groups are: major.minor.build version			
Response Triggers			
Notes			

12.2.1 On/Off

Number	Value
0	Off
1	On

12.2.2 Signal Type

Number	Value
0	No signal
1	DVI
2	HDMI
3	DisplayPort
4	HDBaseT
5	SDI
6	VGA
7	Follow output
8	DGKat

12.2.3 Video/Audio Signal Changes

Number	Value
0	Video signal lost
1	New video signal detected
2	Audio signal lost
3	Audio signal detected
4	Disable 5V on video output if no input signal detected
5	Video cable unplugged
6	Audio cable unplugged

12.2.4 EDID Source

Number	Value
0	Input
1	Output
2	Default EDID

12.2.5 EDID Audio Capabilities

Number	Value
0	LPCM 2CH
1	LPCM 6CH
2	LPCM 8CH
3	Bitstream
4	HD

12.2.6 Layer Enumeration

Number	Value
1	Video
2	Audio
3	Data
4	IR
5	USB

12.2.7 Signal Validation

Number	Value
0	Signal or sink is not valid
1	Signal or sink is valid
2	Sink and EDID is valid

12.2.8 Ethernet Port Types

Number	Value
0	TCP
1	UDP

12.2.9 HDCP Types

Number	Value
0	HDCP Off
1	HDCP On
2	Follow input
3	Mirror output ("MAC mode")

LIMITED WARRANTY

The warranty obligations of Kramer Electronics for this product are limited to the terms set forth below:

What is Covered

This limited warranty covers defects in materials and workmanship in this product.

What is Not Covered

This limited warranty does not cover any damage, deterioration or malfunction resulting from any alteration, modification, improper or unreasonable use or maintenance, misuse, abuse, accident, neglect, exposure to excess moisture, fire, improper packing and shipping (such claims must be presented to the carrier), lightning, power surges, or other acts of nature. This limited warranty does not cover any damage, deterioration or malfunction resulting from the installation or removal of this product from any installation, any unauthorized tampering with this product, any repairs attempted by anyone unauthorized by Kramer Electronics to make such repairs, or any other cause which does not relate directly to a defect in materials and/or workmanship of this product. This limited warranty does not cover cartons, equipment enclosures, cables or accessories used in conjunction with this product.

Without limiting any other exclusion herein, Kramer Electronics does not warrant that the product covered hereby, including, without limitation, the technology and/or integrated circuit(s) included in the product, will not become obsolete or that such items are or will remain compatible with any other product or technology with which the product may be used.

How Long Does this Coverage Last

Seven years as of this printing; please check our Web site for the most current and accurate warranty information.

Who is Covered

Only the original purchaser of this product is covered under this limited warranty. This limited warranty is not transferable to subsequent purchasers or owners of this product.

What Kramer Electronics will do

Kramer Electronics will, at its sole option, provide one of the following three remedies to whatever extent it shall deem necessary to satisfy a proper claim under this limited warranty:

1. Elect to repair or facilitate the repair of any defective parts within a reasonable period of time, free of any charge for the necessary parts and labor to complete the repair and restore this product to its proper operating condition. Kramer Electronics will also pay the shipping costs necessary to return this product once the repair is complete.
2. Replace this product with a direct replacement or with a similar product deemed by Kramer Electronics to perform substantially the same function as the original product.
3. Issue a refund of the original purchase price less depreciation to be determined based on the age of the product at the time remedy is sought under this limited warranty.

What Kramer Electronics will not do Under This Limited Warranty

If this product is returned to Kramer Electronics or the authorized dealer from which it was purchased or any other party authorized to repair Kramer Electronics products, this product must be insured during shipment, with the insurance and shipping charges prepaid by you. If this product is returned uninsured, you assume all risks of loss or damage during shipment. Kramer Electronics will not be responsible for any costs related to the removal or re-installation of this product from or into any installation. Kramer Electronics will not be responsible for any costs related to any setting up this product, any adjustment of user controls or any programming required for a specific installation of this product.

How to Obtain a Remedy under this Limited Warranty

To obtain a remedy under this limited warranty, you must contact either the authorized Kramer Electronics reseller from whom you purchased this product or the Kramer Electronics office nearest you. For a list of authorized Kramer Electronics resellers and/or Kramer Electronics authorized service providers, please visit our web site at www.kramerelectronics.com or contact the Kramer Electronics office nearest you.

In order to pursue any remedy under this limited warranty, you must possess an original, dated receipt as proof of purchase from an authorized Kramer Electronics reseller. If this product is returned under this limited warranty, a return authorization number, obtained from Kramer Electronics, will be required. You may also be directed to an authorized reseller or a person authorized by Kramer Electronics to repair the product.

If it is decided that this product should be returned directly to Kramer Electronics, this product should be properly packed, preferably in the original carton, for shipping. Cartons not bearing a return authorization number will be refused.

Limitation on Liability

THE MAXIMUM LIABILITY OF KRAMER ELECTRONICS UNDER THIS LIMITED WARRANTY SHALL NOT EXCEED THE ACTUAL PURCHASE PRICE PAID FOR THE PRODUCT. TO THE MAXIMUM EXTENT PERMITTED BY LAW, KRAMER ELECTRONICS IS NOT RESPONSIBLE FOR DIRECT, SPECIAL, INCIDENTAL OR CONSEQUENTIAL DAMAGES RESULTING FROM ANY BREACH OF WARRANTY OR CONDITION, OR UNDER ANY OTHER LEGAL THEORY. Some countries, districts or states do not allow the exclusion or limitation of relief, special, incidental, consequential or indirect damages, or the limitation of liability to specified amounts, so the above limitations or exclusions may not apply to you.

Exclusive Remedy

TO THE MAXIMUM EXTENT PERMITTED BY LAW, THIS LIMITED WARRANTY AND THE REMEDIES SET FORTH ABOVE ARE EXCLUSIVE AND IN LIEU OF ALL OTHER WARRANTIES, REMEDIES AND CONDITIONS, WHETHER ORAL OR WRITTEN, EXPRESS OR IMPLIED. TO THE MAXIMUM EXTENT PERMITTED BY LAW, KRAMER ELECTRONICS SPECIFICALLY DISCLAIMS ANY AND ALL IMPLIED WARRANTIES, INCLUDING, WITHOUT LIMITATION, WARRANTIES OF MERCHANTABILITY AND FITNESS FOR A PARTICULAR PURPOSE. IF KRAMER ELECTRONICS CANNOT LAWFULLY DISCLAIM OR EXCLUDE IMPLIED WARRANTIES UNDER APPLICABLE LAW, THEN ALL IMPLIED WARRANTIES COVERING THIS PRODUCT, INCLUDING WARRANTIES OF MERCHANTABILITY AND FITNESS FOR A PARTICULAR PURPOSE, SHALL APPLY TO THIS PRODUCT AS PROVIDED UNDER APPLICABLE LAW.

IF ANY PRODUCT TO WHICH THIS LIMITED WARRANTY APPLIES IS A "CONSUMER PRODUCT" UNDER THE MAGNUSON-MOSS WARRANTY ACT (15 U.S.C.A. §2301, ET SEQ.) OR OTHER APPLICABLE LAW, THE FOREGOING DISCLAIMER OF IMPLIED WARRANTIES SHALL NOT APPLY TO YOU, AND ALL IMPLIED WARRANTIES ON THIS PRODUCT, INCLUDING WARRANTIES OF MERCHANTABILITY AND FITNESS FOR THE PARTICULAR PURPOSE, SHALL APPLY AS PROVIDED UNDER APPLICABLE LAW.

Other Conditions

This limited warranty gives you specific legal rights, and you may have other rights which vary from country to country or state to state.

This limited warranty is void if (i) the label bearing the serial number of this product has been removed or defaced, (ii) the product is not distributed by Kramer Electronics or (iii) this product is not purchased from an authorized Kramer Electronics reseller. If you are unsure whether a reseller is an authorized Kramer Electronics reseller, please visit our Web site at www.kramerelectronics.com or contact a Kramer Electronics office from the list at the end of this document.

Your rights under this limited warranty are not diminished if you do not complete and return the product registration form or complete and submit the online product registration form. Kramer Electronics thanks you for purchasing a Kramer Electronics product. We hope it will give you years of satisfaction.

KRAMER



P/N: 2900-300422



Rev: 1



SAFETY WARNING

Disconnect the unit from the power supply before opening and servicing

For the latest information on our products and a list of Kramer distributors, visit our Web site to find updates to this user manual.

We welcome your questions, comments, and feedback.

www.kramerAV.com
info@kramerel.com