



User's Guide

Dimensions 4000 Series
Control System



Topics at a Glance

Installation	See Installation Guide
Quick Start Configuration.....	11
User Interface	8
Initial Setup.....	19
Scheduling	63
Scene Recording	54
Detailed Operation	45
System Layout Charts	69

Table of Contents

Table of Contents.....	2
Warnings.....	4
Overview	5
Installation Recommendations.....	6
Getting around the Interface.....	7
Quick Start Configuration.....	10
D4104, D4106, D4206.....	11
D4006.....	13
D4200.....	14
Power Up Initialization.....	16
Setup	18
Accessing the Configuration Menus.....	19
Network Settings.....	20
The Patch.....	23
Zone to Channel Patch	24
Dimmer to Circuit Patch.....	27
Configuring Dimmers.....	28
Devices with Dimmers Only (D4006).....	33
Miscellaneous Settings Menu.....	35
Personalities	41
Connecting Entrance Stations.....	42
Operation	44
Overview of Unit Controls	44
Configure the Clock.....	52
Recording a Scene	53
Changing the MAX and OFF	55
Zone Labels: Naming a Scene or Zone....	55
Preventing Changes - LOCKS	58
Scheduled Events.....	62
Viewing Scheduled Events	64
Sequencer	64
System Layout Charts.....	68
Latitude & Longitude Chart	74

OVERVIEW

QUICK START

SETUP

OPERATION

CONFIGURATION

Warnings

- 1:** To be installed and/or used in accordance with appropriate electrical codes and regulations.
- 2:** To be installed by a qualified Electrician.
- 3:** DO NOT CONNECT line voltage wires to low voltage terminals.
- 4:** For longest lamp life, most lamp manufacturers recommend their fluorescent lamps should be operated at full brightness for a minimum of 100 hours before dimming is permitted.
- 5:** For best results, lamp brands and types should not be intermixed on a circuit
- 6:** Disconnect power when servicing the dimmer, fixture or when changing lamps.
- 7:** All devices in the D4000 system are rated for Indoor use only.
- 8:** TO AVOID FIRE, SHOCK OR DEATH: TURN OFF POWER AT MAIN CIRCUIT BREAKER OR FUSE AND TEST THAT THE POWER IS OFF BEFORE WIRING!
- 9:** Test all circuits for any fault before connecting to this device. Damage to this device due to any fault at the load or line side is not covered by this products warranty.
- 10:** Know the connected load type
- 11:** DO NOT connect load types for which the device is not rated

OVERVIEW

QUICK START

SETUP

OPERATION

CONFIGURATION

Overview

This guide is split into several sections:

- Overview - Overview of manual, key topics, and device navigation
- Quick Start - Critical steps for getting up and running quickly.
- Setup - In-depth topics required for proper initial setup
- Operation - How to operate your device and the features of the user interface
- Configuration - Detailed configuration information

Accompanying this guide should be an installation guide covering all the connections and other requirements of proper installation.

Common Topics

- How to operate the device, see page 45.
- Power Up Initialization, see page 17.
- How to configure a dimmer for a fluorescent (or any other load type,) see page 29.
- How to set the starting network channel, see page 26.
- How to record a scene, see page 50.
- How to set the date and time, see page 53.
- How to prevent changes to the device, see page 59.
- How to trigger a scene at a specific time of day see page 63.

Installation Recommendations

For best results using the Dimension 4000 Architectural Lighting Controllers, follow these recommendations:

- 1:** Plan the system before beginning the installation:
 - *Device location and primary purpose*
 - *Determine which controllers are controlling which dimmers*
 - *Determine location and function of remote stations*
 - *Consider power supply, wire size, run length, load requirements*
 - *Consider any regularly scheduled events.*
- 2:** Follow the installation instructions covering physical installation, connections and wiring of your device
- 3:** Use the information in this "setup" section of this guide for initial setup, and the "configuration" section for regular programming.
- 4:** When configuring a system with multiple devices it's helpful to connect them one at a time so that any problems are isolated as they arise. For example:
 - *First install & configure master stations,*
 - *Confirm that the master station is working correctly,*
 - *Install first entry station (or device), configure it, and confirm that it's working correctly*
 - *Repeat until all devices are installed*

OVERVIEW

QUICK START

SETUP

OPERATION

CONFIGURATION

Getting around the Interface

A full discussion of how to operate your device is covered in the section titled "Operation" on page 45. We recommend that you review this information in its entirety. Contained in this section is only a brief overview to the topic.

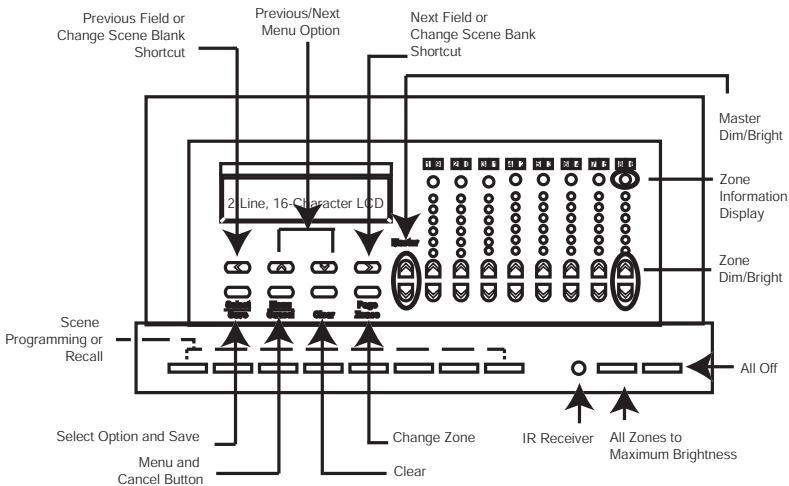

Figure 15 - D4200 Buttons

Controls

With the cover closed, you can access the first eight **SCENE** buttons and the **MAX** and **OFF** buttons.

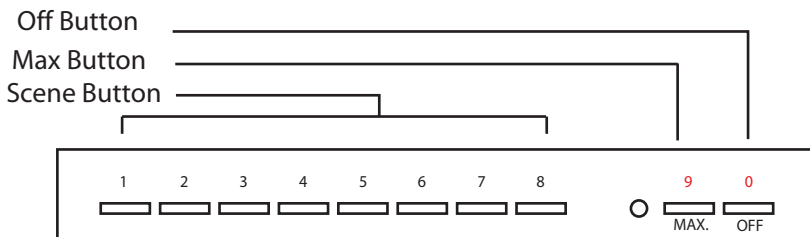





Figure 14 - Scene, MAX and OFF button Locations

- **SCENES 1-8.** Selects a new Scene, and causes a pre programmed set of lighting levels to fade in while the previously selected Scene fades out.
- **MAX.** By default raises all zones to full.
- **OFF.** By default, raises all zones to zero output.

With the cover open, you can also access the LCD display, the **Master Up**  and **Down**  buttons, the individual Zone **Up**  and **Down**  buttons, the Zone identification and status buttons, the Zone level indicators, and the programming/navigation buttons.

Navigating Menus

To navigate the menus, use the programming/navigation buttons:

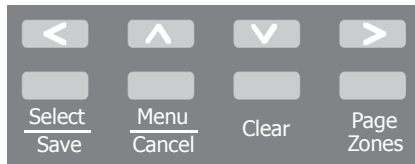



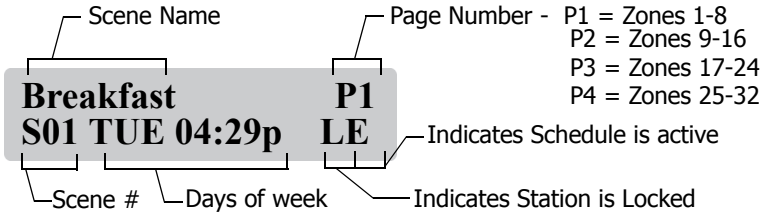

Figure 11 - Programming Buttons

- **Left**  and **Right** . Moves the cursor back and forth, or to the previous or next item.
- **Up**  and **Down** . Scrolls through menus and submenus; changes selected values.
- **Select/Save.** Selects a value to be modified; saves the modified value.
- **Menu/Cancel.** Enters menu mode; exits submenus; exits menu mode.
- **Clear.** Clears or returns a selected value to zero.
- **Page Zones.** Alternates the Zone numbers between 1-8 and 9-16, 17-24 and 25-32. The LCD will indicate which Page you are currently in. P1 refers to Zones 1-8, P2

indicates Zone 9-16, P3 indicates Zone 17-24 and P4 indicates Zones 25-32 are active.



NOTE The Zone number LED's do not light up on P3 or P4

Quick Start Configuration

This section outlines only the steps required to properly setup and begin use of your product. A complete review of all information contained in this guide will help you get the most out of your system.

OVERVIEW

QUICK START

SETUP

OPERATION

CONFIGURATION

Table 1: Find your Product

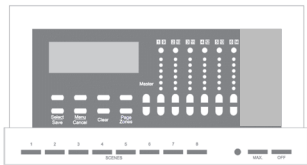
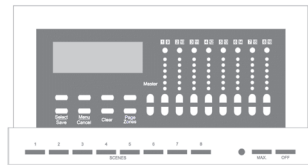
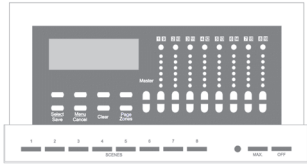
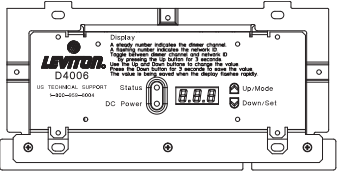
4104 or 4106	4200
<p>Quick Start on page 12</p>  <p>Part numbers: D4104-*** D4106-***</p> <p>Control Channels: 4 Local Dimmers: 4 Can control net device: NO</p>	<p>Quick Start on page 15</p>  <p>Part number: D4200-***</p> <p>Control Channels: 32 Local Dimmers: 0 Can control net device: Yes</p>
4206	4006
<p>Quick Start on page 12</p>  <p>Part numbers: D4206-***</p> <p>Control Channels: 32 Local Dimmers: 6 Can control net device: Yes</p>	<p>Quick Start on page 12</p>  <p>Part numbers: D4206-***</p> <p>Control Channels: 32 Local Dimmers: 6 Can control net device: n/a</p>

Each model has a slightly different feature set so the application of each step may vary slightly.

Devices with Channel Control & Dimmers (D4104, D4106, D4206)

Setting up units with control and dimmers require a few basic steps which when followed will ensure success of your lighting control system:

- Step 1:** Confirm all connections have been completed and load circuits are without fault.
- Step 2:** Confirm network is terminated correctly, reference installation guide for additional information.
- Step 3:** Complete all "System Layout Charts" on page 69 to confirm a clear understanding of all system and configuration requirements.
- Step 4:** Review "Navigating the Menus" on page 50
- Step 5:** Power up unit
- Step 6:** Perform "Power Up Initialization" on page 17 (or review "Setting the Network ID" on page 21)
- Step 7:** For load types that are not incandescent, adjust dimmer load types appropriate. See "Configuring Dimmers" on page 29
- Step 8:** If there is more than one master station on the network, set the starting channel address for this group of dimmers. Each controller should address it's own unique range of channels. See "To Assign Zones, consecutively, from a Starting Channel Number:" on page 26.
- Step 9:** Repeat above steps 4-7 for all other devices on the network. This is especially critical for other D4006 remote dimmers which will be controlled by this Master.
- Step 10:** Push the MAX button
 - CONFIRM that all loads of this device and any remote dimmer go to full. If they DO, CONGRATULATIONS! You have made it a long ways towards a successful installation.
- Step 11:** Slave any remote/entrance stations to this device. (See "Connecting Entrance Stations" on page 43.)

- Step 12:** Configure the clock - Set the date & time. See "Configure the Clock" on page 53.
- Step 13:** If scheduling events around sunrise or sunset, setup the astronomical time clock on page 54.
- Step 14:** Record your scenes, see "Recording a Scene" on page 54.
- Step 15:** Setup events which should occur on a regular schedule, "Scheduled Events" on page 63.
- Step 16:** Celebrate! You're all done.
- Depending upon the desired specific behavior of this device, configuration may be complete or additional modifications may be necessary. Regardless, a full perusal of this manual is required to understand all device configuration options.

OVERVIEW

QUICK START

SETUP

OPERATION

CONFIGURATION

Devices with dimmers only (D4006)

Setting up units with only dimmers requires a few basic steps which when followed will ensure success of your lighting control system:

- Step 1:** Confirm all connections have been completed and load circuits are without fault.
- Step 2:** Confirm network is terminated correctly, reference installation guide for additional information.
- Step 3:** Complete all "System Layout Charts" on page 69 to confirm a clear understanding of all system and configuration requirements.
- Step 4:** Set the network ID, see page 34.
- Step 5:** Set the starting channel number, see page 34.
- Step 6:** For any load types which are not incandescent, adjust dimmer load types as appropriate. See "Configuration of Dimmers at another panel" on page 32
- Step 7:** Configure ID's and channel patches at all other network devices.
- Step 8:** From the controlling device, activate the lighting levels in this dimmer. If controlling from a D4200 or D4206, simply pushing the MAX button will do.
- Step 9:** Celebrate!!! You're all done.
 - Depending upon the desired specific behavior of this device, configuration may be complete or additional modifications may be necessary. Regardless, a full perusal of this manual is required to understand all device configuration options.

Devices with Channel Control only (D4200)

Setting up units with control and dimmers require a few basic steps which when followed will ensure success of your lighting control system:

- Step 1:** Confirm all connections have been completed.
 - *Network connections are required*
 - *Connection to adequate power supply is required*
 - *Lock/Occ input is an optional connection*
- Step 2:** Confirm network is terminated correctly, reference installation guide for additional information.
- Step 3:** Complete all "System Layout Charts" on page 69 to confirm a clear understanding of all system and configuration requirements.
- Step 4:** Review "Navigating the Menu" on page 50
- Step 5:** Power up unit
- Step 6:** Perform "Power Up Initialization" on page 17 or review "Setting the Network ID" on page 21
- Step 7:** Perform setup of other network devices, dimmers, etc.
- Step 8:** Confirm this device is patched to the correct channels. Reference "To Assign Zones, consecutively, from a Starting Channel Number:" on page 26.
- Step 9:** Push the MAX button
 - CONFIRM that all loads controlled by this device go to full. If they DO, CONGRATULATIONS! You have made it a long ways towards a successful installation.
- Step 10:** Slave any remote/entrance stations to this device. (p.43)
- Step 11:** Configure the clock - Set the date & time. See "Configure the Clock" on page 53.
- Step 12:** If scheduling events around sunrise or sunset, setup the astronomical time clock on page 54.
- Step 13:** Record your scenes, see "Recording a Scene" on page 54.
- Step 14:** Setup events which should occur on a regular schedule, "Scheduled Events" on page 63.

OVERVIEW

QUICK START

SETUP

OPERATION

CONFIGURATION

Step 15: Celebrate!!! You're all done.

- Depending upon the desired specific behavior of this device, configuration may be complete or additional modifications may be necessary. Regardless, a full perusal of this manual is required to understand all device configuration options.

Power Up Initialization

Upon the initial power up (and anytime the network id is set to 0) a special power up initialization menu is displayed which allows you to configure the following:

- Network ID
- Device Name

These settings must be set prior to any further configuration or use of this device.

Network ID

The network id is the address of this "node" on the network. The ID for every device on the network must be unique.

Enter a unique ID number for this station in the space provided this space.

```
EDIT NETWORK
ID=001 MASTER
```

When you've finished entering the network ID, press the down arrow to advance to the next setting.

Device Name

Each device may have a unique name. The default name is a derivation of the model number, however, it is recommended that you give it a unique name which makes more sense to you. Examples of good names are: "South Wing", "Room 221", "Main Office", etc.

```
EDIT NETWORK
NAME=D4206 1
```

Enter a network name. Names can be entered using the **UP/DOWN/LEFT/RIGHT** arrows, or you can use the Zone Information, Up/Down, and number keys to enter alphanumeric characters.

OVERVIEW

QUICK START

SETUP

OPERATION

CONFIGURATION

What's next?

This completes the initial power up configuration. However, before your unit is completely ready to go, please return to Quick Start Configuration (p.11), or, turn a few more pages (p.19) to continue the setup of your device.

Setup

The setup section covers all requirements to ready this device for use. Generally, the settings in this section are only required the first time your device is put into service. More routine configuration requirements are covered in the operation and configuration sections of this manual.

To complete setup you must use both of the basic and advanced menus. The functionality of the basic operation menus can be found in the section "Operation" on page 45. The advanced menus required for setup are accessed the same way as the operation mode menus by pressing the "Menu" key. The procedure for enabling the advanced mode menus can be found in the section "Accessing the Configuration Menus" on page 20.

The Basic operation mode menus are used for the following tasks:

- Set Date/Time
- Set Daylight Savings time
- Set record/station locks and their codes
- View, Edit, Activate Schedule
- View, Edit, Activate Sequencer
- Edit Scene Labels
- Edit Excludes

The advanced setup mode menus add the following options:

- Zone Assignment
- Local/Remote dimmer configuration
- Network Settings
- Miscellaneous Settings
- Personalities

OVERVIEW

QUICK START

SETUP

OPERATION

CONFIGURATION

Accessing the Configuration Menus

All configuration is done through the menus of the Dimensions 4000 series controller. Menus are accessed by pressing the "Menu" button and navigating with the Up/Down arrows and the SELECT key.

Operation & Configuration Menus

There are two levels of configuration menus, Basic & Advanced. Basic mode is always available. To enter advanced mode, follow the procedure below:

- Step 1:** Push the MENU button until the display reads the current day and time
- Step 2:** Push and Hold the MENU button for approximately 10 seconds until the display reads:

PLEASE WAIT
REBOOTING

- Step 3:** IMMEDIATELY release the menu button, then press and hold ZONE 4 DOWN for several seconds until the display reads as follows:

ADVANCED
MENUS

When the above 3 steps have been successfully completed, the menu structure will be expanded to include both the operation and configuration mode menus.

Network Settings

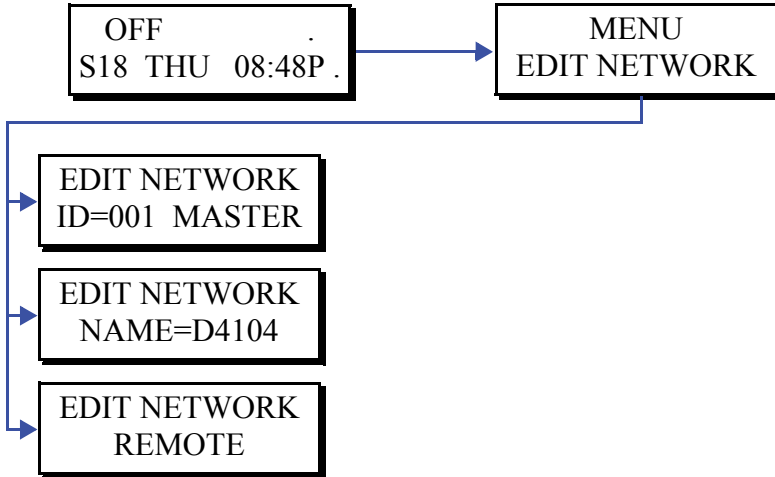

OVERVIEW

QUICK START

SETUP

OPERATION

CONFIGURATION

Setting the Network ID

Each control station must have a unique ID number assigned to it. Network ID which is not set or which is set to Zero (0) will not participate on the network.

EDIT NETWORK
ID=001 MASTER

Valid Range:

- 1-127 - unique network ID

NOTE

These numbers may have been assigned at the factory prior to shipment. When assigned at the factory each station carton is labeled with its ID number.

The network ID must be set to a unique number between 001 and 127. If two stations attempt to share the same network ID, all stations may operate erratically and the dimmers may not respond to any station.

NOTE

Master stations and remote "Entry" stations must be linked so that the master station responds to the correct remote station. Once the stations are linked, each must have a unique network id.

Network Name

Each device should have a unique network name. This helps when identifying this device from other network devices. The network name may be up to (8) characters long

EDIT NETWORK
NAME=D4104

Remoting to another Master Station

LCD stations can be used as a "remote" to another LCD station which is configured as a "master". Any button press on a remote LCD station activates the same button press on the master, and, all LCD messages displayed on the remote are the same as displayed on the master. A remote station can also be remote to another remote.

Remote To Setting:

EDIT NETWORK
REMOTE

Valid Values:

- *MASTER* - not a remote to any master
- *xxx* - ID number of the master station to which this station is a remote

NOTE

Although the LCD messages displayed on a remote are the same as the master, the configuration menus of the remote and master are always separate.

OVERVIEW

QUICK START

SETUP

OPERATION

CONFIGURATION

The Patch

Patch assigns the control "zones" on a device to a network channel, and, if a device is a model with dimmers, assigns the "dimmers" to a network. Remember that these are actually two distinct patches, the first the zone to the network channel, and second the dimmer to the network channel. Terminology introduced in this section is as follows:

- Zone - The smallest unit control from a control device. Zones are connected to 1 or more network channels, OR, a network Group. The Zone sometimes also can be referred to as the 'Control Channel' or just 'Channel' for short. This is not to be confused with the 'Network Channel' which is discussed below.
- Network Channel - The slot on the network to which level information is placed by a zone. Dimmer, relays, and other devices which directly control loads listen for level changes on the network channel to which they are assigned.
- Dimmer, a.k.a 'Circuit' or 'Relay' - The device which controls the load. The collection of dimmers, circuits, relays, and other relevant terminology is generally known as the "circuits"

Depending upon which device you have, its capabilities vary somewhat. Please reference the chart below for the specific patch requirements for your product:

Table 2: Products & Number of Zones

Product	Max # Zones	# Local Dimmers	Zone to Channel Patch	Dimmer to Channel Patch
D4104	4	4	No	No
D4106	6	6	No	No
D4200	32	0	Yes	No
D4206	32	6	Yes	Yes

Zone to Channel Patch

Each device, depending on the model, has a number of different Zones. These zones give you the ability to control both local dimmers, if your device has them, and also possibly remote dimmers via a network channel. The network channel, or simply channel for short, is the location on the network where zone level information is stored for retrieval by devices like dimmers, relays, etc. The Zone/Channel patch establishes the relationship between the zones and the network channel.

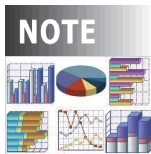

It is helpful to complete the zone patching chart which can be found on page 70.

NOTE

The advanced topic of "Groups" is discussed later on in this guide, however, the configuration of such is covered here.

There are two ways to set the patch, one which assigns a channel to each zone, or, the short cut method of simply setting the **Starting Channel Number** for Zone 1 and the rest of the zones follow sequentially. Setting the patch from a starting channel number should be used when all of the zones on your device will be controlling consecutive network channels. This is the most common configuration.

OVERVIEW

QUICK START

SETUP

OPERATION

CONFIGURATION

To Assign Zones, consecutively, from a Starting Channel Number:

Step 1: From the advanced menus (see page 20), find the menu which reads:



MENU
ASSIGN ZONES?

then press **SELECT**.

Step 2: Use **Down**  buttons until the display reads:



ASSIGN ZONES:
START

Channel Number

then press **SELECT**. The channel number should be flashing.

Step 3: Enter the starting channel number for the first zone on this device, then press **SELECT**. Your zones then will be renumbered.

To Assign Zones, non-consecutively, or edit a particular zone's settings:

Step 1: From the advanced menus (see page 20), find the menu which reads:



MENU
ASSIGN ZONES?

then press **SELECT**.





Step 2: Make adjustments as follows:



Zone Number

ASSIGN ZONES:
Z01:CHANN=0001

Channel Number

- Adjust Zone Number with **Up**  or **Down** 
- Toggle between the Zone Number and CHANN/GROUP setting with **Left**  and **Right** 
- Toggle between the Zone/Channel adjustment with **SELECT**

- 3: When you have completed making changes, press **SELECT/SAVE** to save your changes, ensuring that the zone number is blinking. Then press **MENU** to exit the menu structure.

Groups

A Group is an additional way to reference a collection of dimmers, relays, and other circuits.

- Any circuit **must** be assigned to 1 network channel
- Any circuit **may** be assigned to 1 or more network groups.

Groups are helpful when you used to control logical groupings from one or more buttons, faders, etc. For example, consider a building with an East, West, North, & South wing, each occupied by a different tenant and as such the particular circuiting for every wing changing periodically. You could setup the system so that all dimmers, relays, and controllers had to be reconfigured every time something changed, or, you could use Groups:

- Group 1: East Wing
- Group 2: West Wing
- Group 3: North Wing
- Group 4: South Wing

Additionally, you could create another group, possibly called Group 10, which always controls all lights in the entire facility.

To assign a dimmer in a Dimensions 4000 series product to a Group, please see "Groups A (B, C D)" on page 32.

To assign a zone in a Dimensions 4000 series product to a Group, see "To Assign Zones, non-consecutively, or edit a particular zone's settings:" on page 26.

NOTE

Dimensions 4100 series product are stand-alone devices and DO NOT have the capability to communicate over a network. As such, group settings are not relevant.

OVERVIEW

QUICK START

SETUP

OPERATION

CONFIGURATION

Dimmer to Circuit Patch

Your device, depending on the model, may have a number of dimmers. These dimmers must be assigned (patched) to a network channel. Just like zones, a dimmer may belong to only 1 network channel. However, a dimmer may belong to up to (4) groups. Unlike zones, there is no separate menu structure for the dimmer/circuit patch. It is handled as part of dimmer configuration. For additional information on the implementation of a dimmer/circuit patch, please see "Configuring Dimmers" on page 29.

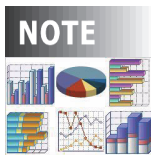

It is helpful to complete the dimmer patching chart on page 71.

Notes on Patching

- The default patch for zones, is a consecutive patch starting at zone 1, channel 1.
- The default patch for dimmers, is a consecutive patch starting at dimmer 1, network channel 1.
- Zones and dimmers need not be patch consecutively
- If you're using the D4206 or D4006, the dimmers will respond to any network command from any network device for that channel.
- If you're using a D4200 or D4206, the zones can be patched to any network channel, 1-2048, and can control any circuit "listening" to that channel.
- If you're using a D410x, the dimmers will only respond to commands issued from the controller containing the dimmers and they do not have any patch settings.

Configuring Dimmers

The dimmer configuration menu is found only in the configuration menus. To access the configuration menus, please see "Accessing the Configuration Menus" on page 20. Although there are many items which may be configured, two are critical:

- Network Channel Number
- Dimmer Type

All other parameters are related to the behavior of the dimmer as part of the system.

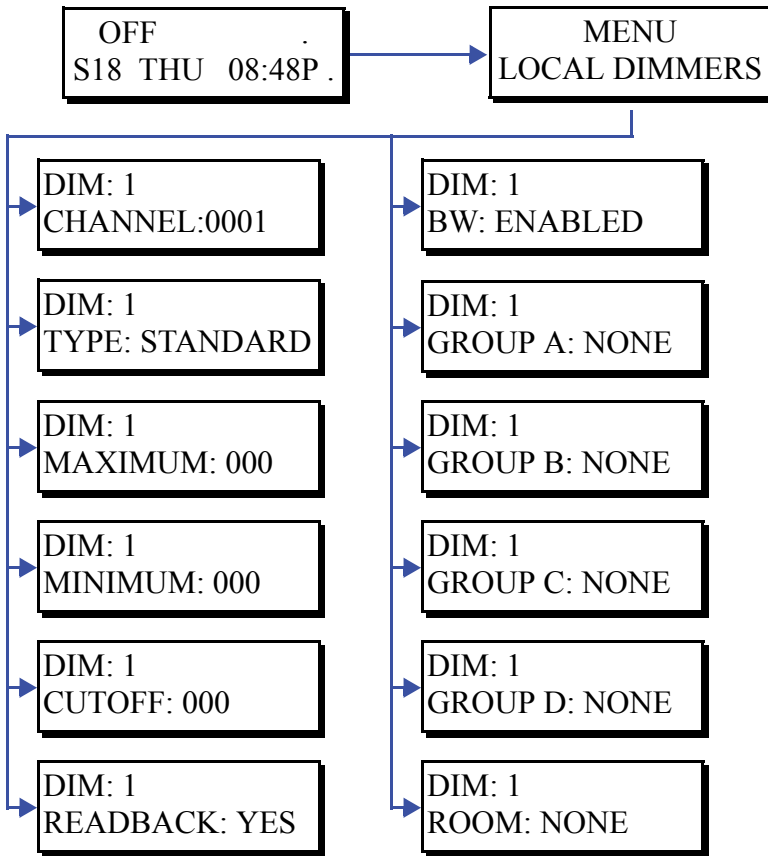

Dimmer Configuration Menu Chart

OVERVIEW

QUICK START

SETUP

OPERATION

CONFIGURATION

To navigate the dimmer configuration menus, the following keys are used:

- Adjust Dimmer Number with **Left** < and **Right** >
- Toggle Dimmer Property with **Up** ^ or **Down** v
- Toggle between the Dimmer/Property selection and property value modification with **SELECT**
- Press **MENU** to exit dimmer configuration

The following properties can be set on this screen:

Channel - This references the "network channel" to which this dimmer will "listen." This option is not available on D4100 and D4200 units. For additional information on the impact of this settings, please reference "Dimmer to Circuit Patch" on page 28.

Channel should be set to the network channel to which this dimmer should respond. Usually it's the same as the dimmer number, or rather 1-6. In some situations when you have multiple master stations, you will need each one set to a unique set of network channels. Valid ranges are 1-2048.

Dimmer Type

The most critical configuration requirement for dimmers is setting them to the correct load type. For example, if the load type of your dimmer is Mark X fluorescent, you must set the type to "MARK X".

Dimmer type must be set to the appropriate load type to which this dimmer is connected. The following options are available:

- STANDARD - Incandescent
- TU WIRE - Lutron Tu-Wire fluorescent dimming ballasts
- MARK X - Advanced Mark 10 fluorescent dimming ballasts
- NON-DIM - Any load type which should not dim. For example, non-dimming ballasts. A non-dim dimmer only turns on or off its load.

Blink Warn

Indicates whether or not this dimmer should respond to a blink warn command. Options are:

- Enabled: dimmer will always respond to a blink warn

- Disabled: dimmer will never respond to a blink warn.

Typically you will only want to disable blink warn for a dimmer when the load connected to that dimmer does not immediately recover from a loss of power; for example, most HID ballasts have a long warm-up time before any usable light is output and as such blink warn should be disabled. However, most fluorescent types have immediate recover and therefore blink warn may be enabled.

Blink warns are used to notify the occupant that the lights are about to be turned off. This notification is in the form of a brief "blink" off of the lights in the room. After the blink has occurred, the user has 5 minutes to cancel the event by pressing any of the normal buttons used to control lighting in the room. If the event is not cancelled, then, the lights will shut off. If the event is cancelled, then the lights will remain in their current state for a time period, then, the process will repeat. Blink - option to cancel - off or override on. The override time period can be set from the MISC SETTINGS menu to 30 minutes, 1 hour, or 2 hours.

Maximum

Sets the maximum value of the dimmer. Values are 0-255, 0=0% output and 255=100% output. Default setting is 255. This setting may be lowered if the dimmer should never exceed a particular light output.

Minimum

Sets the minimum value of the dimmer. Values are 0-255, 0=0% output and 255=100% output. Default setting is 0. This setting should be raised if the dimmer should never go below a particular light level. Please note that a level any higher than 0 will not allow this dimmer to be shut off completely. This setting is useful for night lights which never go off completely.

Cutoff

Sets the lowest level before the dimmer will immediately go off. Valid values are 0-255, default value varies by dimmer types. If you're having trouble with ballasts flickering at low levels, raising this value slightly may resolve the problem.

OVERVIEW

QUICK START

SETUP

OPERATION

CONFIGURATION

Groups A (B, C D)

Each dimmer may be assigned to up to four groups, identified as 'Group A', 'Group B', 'Group C', and 'Group D'. Groups are a collection of dimmers and relays which when controlled as a group are always controlled together. Valid values for a group are 0-9999. Each group setting must be set to a group number, or, 'None'. For more information about group and how they can be used, please see "Groups" on page 27.

For more information about how to control groups with a D4200 or D4206 series controller, please see "To Assign Zones, non-consecutively, or edit a particular zone's settings:" on page 26.

Readback

Indicates whether or not a dimmer will respond to a level or readback request from the network. The default setting is Yes. If you have a situation where more than one dimmer, relay, or other device is assigned to the same network channel, readback should only be enabled for one. Valid settings are as follows:

- *Yes - dimmer will respond to level request*
- *No - dimmer will not respond to level request*

Room

Each dimmer can be assigned to a room. This setting is for compatibility with future released product.

Configuration of Dimmers at another panel

D4206 and D4206 product can be used to configure the dimmers belonging to another D4000 series product (the 'remote') from the local device. Configuration of the remote dimmers is identical to the process for configuring the local dimmers except first you must select the remote to configure. To start the process of configuring remote dimmers:

Step 1: From the advanced menus (see page 20), find the menu which reads:



*then press **SELECT**.*

Step 2: Using **Up**  or **Down** , scroll through the names of the other panels connected to the network until the one you want to configure is visible,



*then press **SELECT**.*

Step 3: Configure the dimmers as you would a local dimmer, reference "Configuring Dimmers" on page 29.

OVERVIEW

QUICK START

SETUP

OPERATION

CONFIGURATION

Devices with Dimmers Only (D4006)

Configuration of a device with dimmers is a two part process: Part 1 is configuration at the device, and part 2 is the configuration of the dimmer parameters from a D4200 OR D4206 master station using the "Remote Panels" menu option.

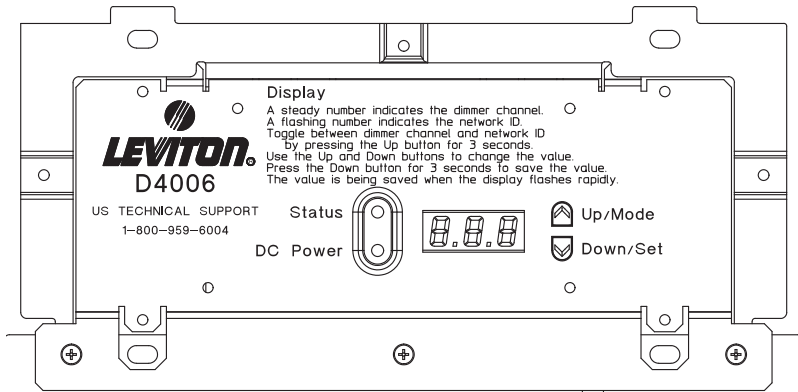

D4006 - Front Panel

At the remote dimmer there are only two things which can be configured:

- Network ID (see page 21.)
- Starting network Channel Number (see page 25.)

For more information about the implication of the two settings, please reference the indicated sections and page numbers.

To set the network ID on a device with only dimmers:

- Step 1:** The display should be flashing approximately once per second indicating that the network id is showing. If not, push and hold the up button for approximately 3 seconds. The display then should be flashing.
- Step 2:** Use the Up/Down arrows until the desired network ID is shown.
- Step 3:** Push and hold the Down/Set button for approximately three seconds until the number start rapidly flashing. This indicates that the new value is being saved.

To set the starting channel number on a device with only dimmers:

- Step 1:** The display should be steady indicating the starting channel number. If it is flashing, push and hold the up button for approximately 3 seconds. The display then will be steady.
- Step 2:** Use the Up/Down arrows until the desired starting channel number is shown.
- Step 3:** Push and hold the Down/Set button for approximately three seconds until the number start rapidly flashing. This indicates that the new value is being saved.

NOTE There are many other configuration parameters for a remote dimmer. These should be set from a D4206 or D4200 master station. Reference "Configuration of Dimmers at another panel" on page 32

OVERVIEW

QUICK START

SETUP

OPERATION

CONFIGURATION

Miscellaneous Settings Menu

The miscellaneous settings menu has settings which affect the general operation of the panel. This menu is only available from the advanced menus (see page 20) and has a structure as follows:

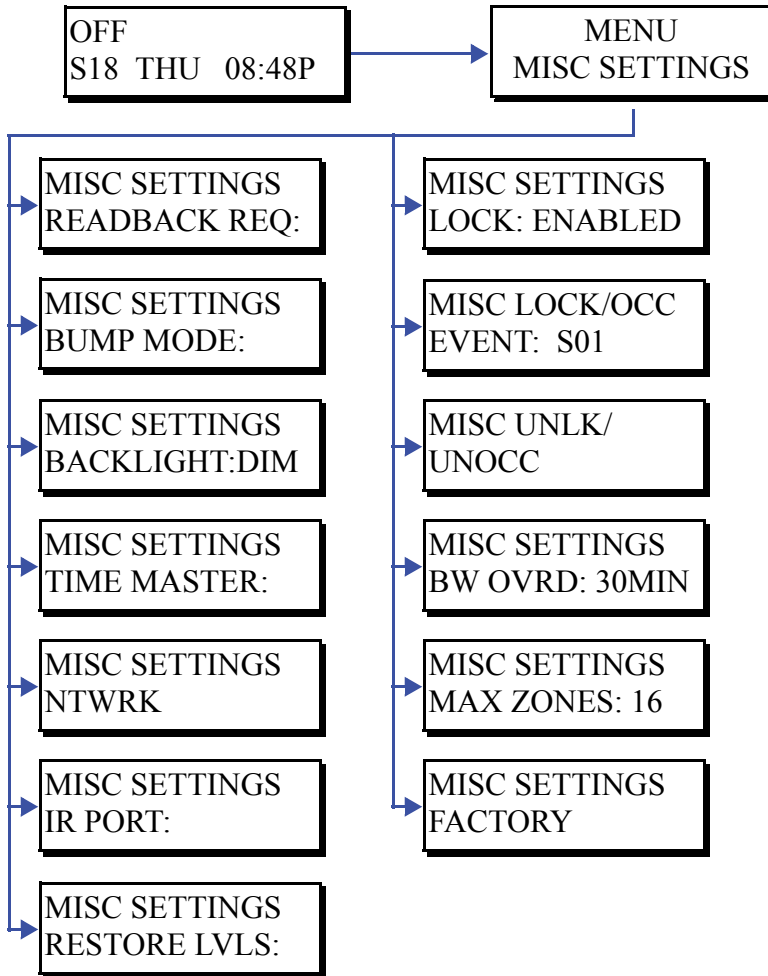

All of the settings on this menu can be changed using the following process:

Step 1: From the advanced menus (see page 20), find the menu which reads:



*then press **SELECT**.*

Step 2: Use **Up**  or **Down**  to select then menu option you wish to edit



*then to edit, press **SELECT**.*

Step 3: Use **Up**  or **Down**  to edit the values, then press **SELECT** to save.

Step 4: Repeat until all settings have been adjusted as appropriate.

The settings which can be adjusted from this menu are as follows:

Readback Request

In the event that multiple control devices are controlling the same dimmer or relay, it's possible that the actual state of the circuit will differ from that of this master station. In this case, it's helpful for this device to periodically check the state of each circuit. This is called "readback" because the level is read back from the circuit. This setting determines whether or not this readback action is periodically performed.

- Yes - dimmer levels will periodically be requested
- No - dimmer levels will never be requested.

Bump Mode

There is a special feature for the **MAX** and **OFF** buttons which upon a double bump (quick double press) instead of going to their user recorded setting, will take all levels instantly to 100% for MAX or all levels instantly to 0% for off. This feature can be controlled from the BUMP MODE option under the misc. settings menu. Valid settings are as follows:

OVERVIEW

QUICK START

SETUP

OPERATION

CONFIGURATION

- USER (default): A double bump calls channel levels recorded by the user
- MAX: A double bump calls channel levels to go to the extreme, either 100% (max) or 0% (off).

Backlight

Controls the behavior of the LCD backlight. Settings are as follows:

- DIMMED: The backlight goes to a dimmed state after 1 minute of inactivity
- OFF (default): The backlight goes off after 1 minute of inactivity.

Time Master

All Leviton products which have an integrated time clock support the time master feature. This feature allows automatic synchronization of time clocks so all clocks are set to the same time. This feature is achieved by the master time clock on the network periodically broadcasting its time to the network, then, all other devices setting their clocks to the time of the master time clock. Valid values for this option are as follows:

- OFF: master time clock is ignored and only the local settings are used.
- RECV: Receive Only - device will listen to broadcasts from a master time clock, and set local time to the master time clock but will never broadcast time.
- MAST: Master - device will always be a Master time clock and will always broadcast time to the network. Although the AUTO setting is almost always preferred, in some cases you may wish to force a device to always be the master. In this case, only one device on the network should be set to the MAST setting, all other should be AUTO or RECV. If upon startup it is detected that a master time clock is already on the network, this device will automatically demote itself to the AUTO setting until its next power-up at which point it will attempt to re-establish itself as the master.
- AUTO (default): the preferred setting for this option. In automatic mode, upon startup this device will listen to the network to determine if a master time clock is already on the network. If a master is detected, it will listen to and set

its time from the master. If no master is detected, then this device will establish itself as the master time clock for the network. When a device is in AUTO mode, anytime a new MASTER time clock broadcast is detected, it will automatically demote itself to receive only mode.

Network Compatibility

This setting is only for use when using a new device with old network devices. The default setting is NEW and should remain as such unless directed to change the value by Technical Services.

IR Port

The IR port can either be enabled or disabled by this setting. Valid values are as follows:

- Enabled: The IR port will receive and process IR signals
- Disabled: The IR port will ignore all IR signals.

LOCK/OCC Input Behavior

The Lock/Occ input can be used to trigger a scene according to either the LOCK OR OCC input at the rear of the device, and, optionally lock the user interface. There are three menu options which effect this feature, each setting is as described below:

- Active Scene

MISC: LOCK/OCC EVENT: S01

indicates the event/scene which should be recalled when the input goes active. If the input used is the OCC input, an active input is indicated by the input received +24Vdc. If the input used is the LOCK input, an active input is indicated by the input being connected to common. Valid settings are:

OVERVIEW

QUICK START

SETUP

OPERATION

CONFIGURATION

- None - nothing happens
- S01....S16 - Scenes 1-16
- MAX - Max Scene
- OFF -Off Scene
- Inactive Scene

MISC: UNLCK/
UNOCCEVENT:

indicates the event/scene which should be recalled when the input goes in-active. If using the OCC input, an inactive input is indicated by the input being 'open' or common. If the input used is the LOCK input, an inactive input is indicated by the input being 'open' or connected to common +V. Event settings for the inactive scene are the same as for the active scene.

- Lock User Interface

MISC SETTINGS
LOCK: ENABLE

indicates whether or not the user interface should be 'locked' when the input goes active, and 'unlocked' when the input goes inactive. When the user interface is locked, no operation or configuration changes may be made. The valid settings for this property are:

- Enabled - The user interface should be locked when the input is active.
- Disabled - The user interface should not be locked when this input is active.

Blink Warn Override Time

This setting sets the time between when a blink warn is overridden and the time when the next blink warn for the same event is issued. For example, let's assume that a device currently has scene 1 active, and at 5:30pm the off scene will be triggered with a blink warn. The blink warn override time is set to 1 hour. The sequence of events would be as follows:

- 5:00pm - Scene 1 Active
- 5:30pm - Off Scene with Blink activated by scheduler

- 5:30pm - Lights Blink, and any wall or master stations controlling that room begin flashing its lights indicating that the blink warn can be cancelled.
- 5:32pm - User presses any flashing button to enter override. (If the user did not press a button, at 5:35pm the off scene would be activated.)
- 5:32pm->6:30pm - Override mode active, scene 1 remains active. Any change to lighting levels accepted during the override time.
- 6:30pm - Lights Blink, and any wall or master stations controlling that room begin flashing its lights indicating that the blink warn can be cancelled.
- User has the option of overriding the off event by pressing any of the lights, in which case the cycle repeats.
- 6:35pm - If the event has not been overridden, the off event will be activated.

OVERVIEW

QUICK START

SETUP

OPERATION

CONFIGURATION

Max Zones

This setting is used to set the maximum number of zones this device will address. This setting is only available on D4200 & D4206 devices. Valid values are 8, 16, 24, or 32 zones.

Factory Defaults

Allows reset of all settings to factory defaults. WARNING: Selecting the factory defaults will irrecoverably erase all events and other configuration you may have entered.

Restore Levels

The Restore LVLS setting defaults to OFF. When set to ON, upon restoration of power after a power failure, the levels of the dimmers will restore to the level they were at prior to the power failure.

MISC: RESTORE
LVLS: ON

Indicates the levels will restore to the level they were at prior to the power failure.

Personalities

You can set up various personalities that include different preset Scenes. For example, a church could use one set of eight preset Scenes for Sunday church service, and a different set of eight preset Scenes for evening choir performances. By choosing Personality 02, the second (choir performance) set of Scenes could be recorded without disturbing the normal Sunday church service settings.

The following information is unique to each personality:

- Scenes (including fade rates)
- Scene Labels
- Remote To ID numbers (unless already at zero (0))
- Assign Zones
- Exclusions
- Zones
- Zone Labels

Connecting Entrance Stations

Most systems involve the use of not only a master station but entrance stations as well. The D4000 system entrance stations must:

- be “slaved” to the master to station which they remotely control, and,
- have a unique network address.

To connect an entrance station to the system:

Step 1: Determine the network id for the entry station

Step 2: If already installed, remove the entry station from the wall and unplug the network cable

Step 3: Set the Network ID dipswitch to the Network ID of the master station to which this device should be slaved

Step 4: Hold down the upper left button on the device and plug in the network connector

- After approximately 10 seconds, the green LEDs will blink. Once this occurs, the id has been successfully programmed and you can move on to the next step.

Step 5: Unplug the network connector

Step 6: Set the Network ID dipswitch to the appropriate network id of the entry station

Step 7: Plug the network cable back into the device and install the unit into the wall.

OVERVIEW

QUICK START

SETUP

OPERATION

CONFIGURATION

Operation

OVERVIEW

The section of this users guide covers the basic operation of the device. Covered are the following topics:

- Operate your device
- Recall scenes
- Manually set zone levels
- Record scenes
- Schedule events
- Prevent changes

QUICK START

Overview of Unit Controls

The front panel controls allow the basic operating requirements of the device. Control of the lighting look, recall of scenes, and changes to configuration are possible.

With the cover closed, you can access the first eight **SCENE** buttons and the **MAX** and **OFF** buttons.

SETUP

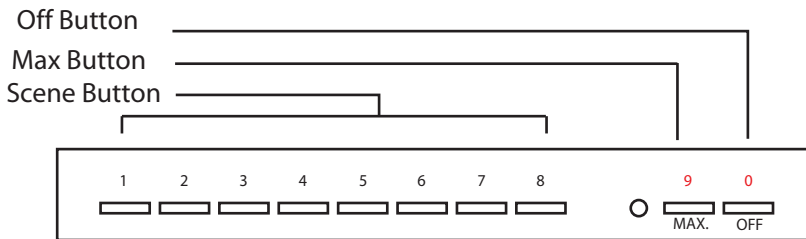





Figure 14 - Scene, MAX and OFF button Locations

OPERATION

- **SCENES 1-8.** Selects a new Scene, and causes a pre programmed set of lighting levels to fade in while the previously selected Scene fades out. Tapping a Scene button twice (if enabled) causes the lighting levels to change immediately, bypassing the fade time. When Scenes are named, the name appears on the LCD display when the button is pressed, for example, "**BREAKFAST, LUNCH, or DINNER.**"

CONFIGURATION

- **MAX.** Brings all assigned lighting levels gradually to the maximum level. Tapping the button twice brings all assigned lighting levels immediately to the maximum level, bypassing the fade time. This button can be programmed for custom lighting levels, for example, reducing the maximum light level to conserve energy, or providing longer lamp life.
- **OFF.** Brings all lighting levels gradually to the minimum level (the default value is no light). Tapping the button twice brings all assigned lighting levels immediately to the minimum level, bypassing the fade time. This button can be programmed for custom lighting levels, for example, keeping a minimum light level for safety reasons.

With the cover open, you can also access the LCD display, the **Master Up**  and **Down**  buttons, the individual **Zone Up**  and **Down**  buttons, the Zone identification and status buttons, the Zone level indicators, and the programming/navigation buttons.

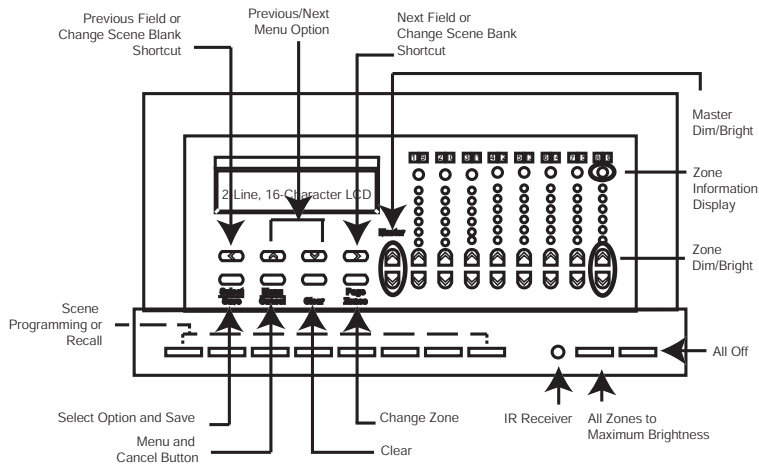

Figure 15 - D4200 Buttons

NOTE

Operate the buttons on the D4200 one at a time.

NOTE

If you activate the station lock code or the station lockout switch, the **Master Up/Down, Zone Up/Down, SCENE, MAX, and OFF** buttons are disabled until a code is entered or the lockout switch is deactivated (see *"Overriding a Lock" on page 62*).

Controlling Lighting Levels

You can control the lighting levels in two ways. You can change all the lights at once, or change individual lighting levels without changing the presets.

The approximate lighting level for each Zone is represented by the Zone level LED indicators.

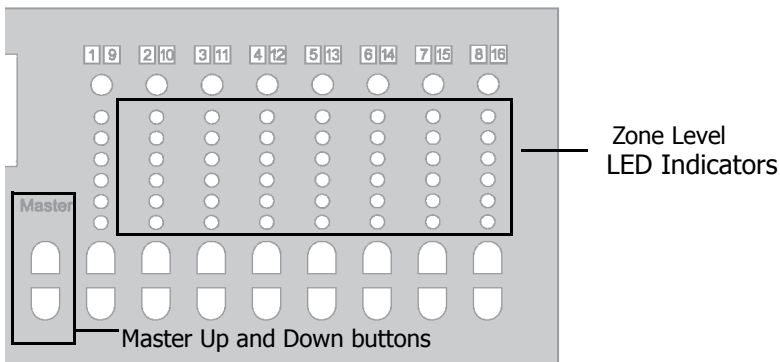

Figure 17 - Zone Level Indicators

Overall Lighting Levels

To adjust overall lighting levels, open the cover and use the **Master Up** ▲ and **Down** ▼ buttons. Once you have recorded Scenes, use these buttons to modify all the Zones concurrently.

- To increase or decrease all assigned lighting Zones by one percent, momentarily press the **Master Up** ▲ or **Down** ▼ button.

OVERVIEW

QUICK START

SETUP

OPERATION

CONFIGURATION

- To rapidly increase or decrease the lighting levels, press and hold the button.

The approximate lighting levels for each Zone are represented by the Zone level indicators. The lighted Scene button goes dark and the LCD display shows **MANUAL MODE** after the **Master Up** ▲ or **Down** ▼ button is pressed. You can record these new values for the Scene if you prefer the new lighting levels.

NOTE

Since levels in all assigned Zones increase or decrease by the same amount, lighting levels eventually become the same in all Zones when you press the **Master Up** ▲ or **Down** ▼ buttons. As each Zone reaches its maximum or minimum level, it stays at that level while the other Zones catch up.

Individual Lighting Levels

Open the cover to access the lighting level buttons. Using the Zone **Up** ▲ and **Down** ▼ buttons, adjust the individual lighting levels for each of the zones. The approximate lighting level for each Zone is represented by the Zone level LED indicators. The exact percentage for each Zone is shown on the LCD display.

NOTE

There is an indicator (P1 or P2 or P3 or P4) in the upper right corner of the display to inform you what page of zones you are currently in. Press the **Page Zones** button to alternate the Zone numbers between P1 (1-8) P2 (9-16), P3 (17-24) and P4 (25-32). When in P3 or P4 the Zones LED indicators will not light)

- To increase or decrease a Zone lighting level by one percent, momentarily press any Zone **Up** ▲ or **Down** ▼ button.
- To rapidly increase or decrease a Zone lighting level, press and hold the button.

NOTE

The lighted Scene buttons go dark and the LCD display shows **MANUAL MODE** after any Zone **Up** ▲

or **Down**  button is pressed. You can record these new values for the Scene if you prefer the new lighting levels.

Checking Zone Names and Lighting Levels

The Zone Status buttons are located above the Zone LED level indicators.

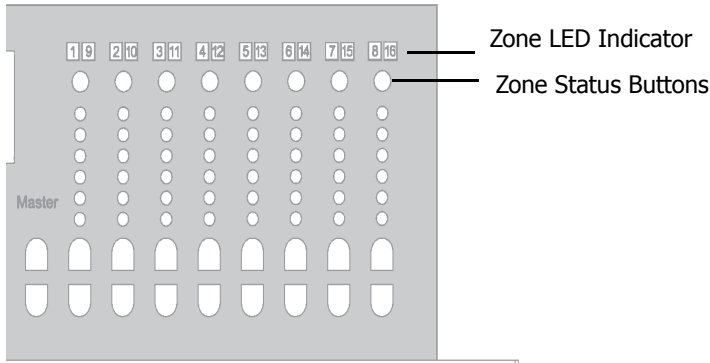

Figure 18 - Zone Status Buttons

To check a Zone:

Step 1: Press a Zone status button.

- The LCD display shows the Zone number or name (if you have programmed one); the precise lighting level is displayed as a percentage. Current lighting levels are not affected.

ZONE:08
Z08: LEVEL= 26%

The LCD display returns to normal after a few seconds.

NOTE

Just to the right of the "Zxx:" symbol on the 2nd line is a field that is normally blank. If this Zone is excluded from the current scene, a minus sign ("-") appears in this position.

OVERVIEW

QUICK START

SETUP

OPERATION

CONFIGURATION

Checking Scene Names

You can check for a Scene name without initiating the Scene.

To Check the Scene Name:

Step 1: Press the **CLEAR** Button

Step 2: Immediately Press the **SCENE** button you are interested in.

Step 3: To View another Scene name, Repeat from Step 1.

Using the Optional Remote Control

If you have purchased the optional infrared remote control, you can use it to operate the Master **RAISE/ LOWER, SCENE, MAX** and **OFF** buttons in the same manner as indicated above. The maximum range for the remote control is approximately 30 feet, line of sight. Additional infrared receivers are also available.

Navigating the Menu

To navigate the configuration and setup menus, use the navigation buttons:

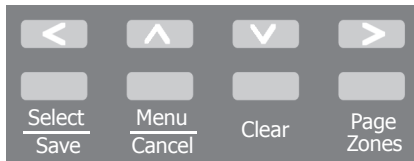



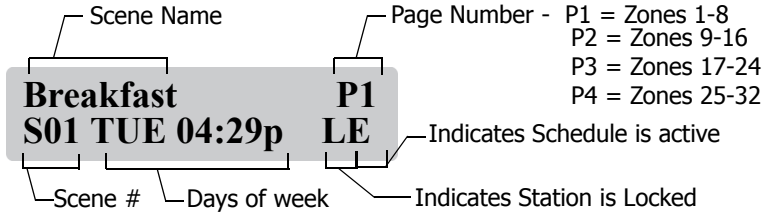

Figure 11 - Programming Buttons

- **Left**  and **Right** . Moves the cursor back and forth, or to the previous or next item.
- **Up**  and **Down** . Scrolls through menus and submenus; changes selected values.
- **Select/Save**. Selects a value to be modified; saves the modified value.
- **Menu/Cancel**. Enters menu mode; exits submenus; exits menu mode.
- **Clear**. Clears or returns a selected value to zero.

- **Page Zones.** Alternates the Zone numbers between 1-8 and 9-16, 17-24 and 25-32. The LCD will indicate which Page you are currently in. P1 refers to Zones 1-8, P2 indicates Zone 9-16, P3 indicates Zone 17-24 and P4 indicates to Zones 25-32 are active.







NOTE

The Zone number LEDs do not light up on P3 or P4

Enabling the Sequencer

This function globally enables or disables the sequencer.

To enable or disable the sequencer:

- Step 1:** Press the **Menu/Cancel** button.
- Step 2:** Press the **Up**  and **Down**  buttons until **SEQUENCER=** flashes on the LCD display.
- Step 3:** Press the **Select/Save** button.
 - *The OFF or ON value flashes.*
- Step 4:** Press the **Up**  and **Down**  buttons to change the value.
 - *Note: Press Clear to change the value to OFF.*
- Step 5:** Press the **Select/Save** button to save the value.
- Step 6:** Press the **Menu/Cancel** button to exit this menu.

OVERVIEW

QUICK START

SETUP

OPERATION

CONFIGURATION

Configure the Clock

Complete configuration of the clock requires access to the advanced menus and involves two steps: Setting the Date/Time, and setting AstroTime.

Set the Date/Time

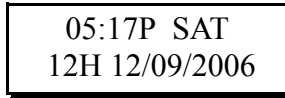

Using Up/Down/Left/Right, set the current time, date, and 12 or 24 Hour mode.

Set Daylight Savings Time



Use Up/Down to select:

- Off - No daylight savings time
- North America - Standard North American daylight savings time
- US 2007 - United States daylight savings time (changed) in 2007
- European Union - European daylight savings time

OVERVIEW

QUICK START

SETUP

OPERATION

CONFIGURATION

Set AstroTime

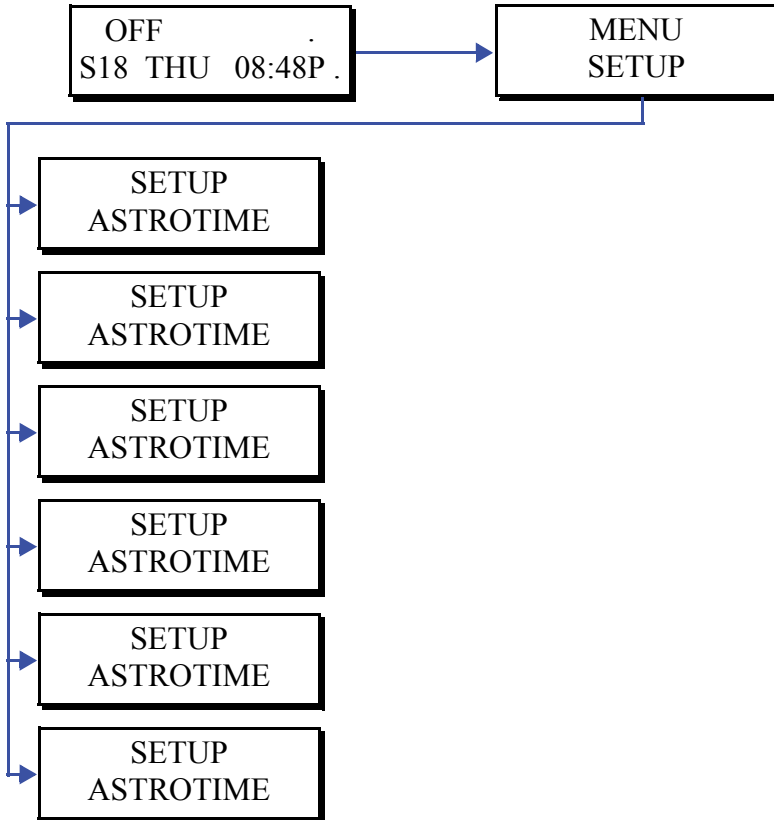

NOTE Setting up the Astronomical Time clock of your Dimensions 4000 unit requires access to the Advanced Menus. See "Accessing the Configuration Menus" on page 20.



Recording a Scene

After adjusting individual lighting levels, you can record lighting levels to a Scene.





Step 1: With the cover open, press and hold the Scene button you want to record until the LCD display shows **FADETIME**.

- *The flashing number indicates the fade time in seconds.*

Step 2: Press the **Up**  and **Down**  buttons beneath the LCD display to adjust the fade time.

Step 3: Press the **Right**  button to select the REC TO SCENE option.

Step 4: Press the **Up**  and **Down**  buttons beneath the LCD display to pick the Scene you wish to record.

Step 5: Press the **Select/Save** button to record the lighting levels and fade time.

- *The LCD display shows RECORDING SCENE TO S00, with s00 representing the Scene you chose.*

Recording Scenes from an Entry Station

You can record scenes from an entry station.

Step 1: Press and hold the Scene button (approximately 5 seconds) you wish to record/snapshot the level too, until the button LED finally lights up.

Step 2: You are finished!

NOTE

The default fade rate time for that scene will be 5 seconds. The only way to record the scene with a different fade rate is to record the scene from the Master LCD station.

OVERVIEW

QUICK START

SETUP



OPERATION

CONFIGURATION

Changing the MAX and OFF Lighting Levels

Reducing the maximum output voltage to the lamps by 5% can extend lamp life significantly. This can be valuable when incandescent lights are located where it is difficult to replace them.

To change the MAX lighting level:

- Step 1:** Press the **MAX** button.
 - *The lighting levels fade to the current maximum level.*
- Step 2:** Using the Zone **Up**  or **Down**  buttons beneath the LCD display to adjust each zone to the maximum value that you need.
- Step 3:** Press and hold the **MAX (or OFF)** button to record the scene and set fade times just like you would scenes 1-16.







NOTE



When the Double Bump feature is on, tapping the MAX or OFF buttons twice overrides any high and low limits. Therefore, if MAX and OFF are set at any levels other than full bright and full off, the Double Bump feature should be turned off.

Zone Labels: Naming a Scene or Zone

You can program alphanumeric labels with up to **14** characters for any **Scene MAX**, **OFF** or **Zone ID** buttons.

To name a Scene or a Zone:

- Step 1:** Press the **Menu/Cancel** button.
- Step 2:** Press the **Up**  and **Down**  buttons until **EDIT LABELS?** flashes on the LCD display.
- Step 3:** Press the **Select/Save** button.
- Step 4:** Press the **SCENE**, **MAX**, **OFF**, Zone ID or **Up**  or **Down**  button you want to edit.
- Step 5:** Press the **Left**  and **Right**  buttons to select a character to edit, or proceed to the next step if you want to change the current character.

- Step 6:** Press the **Up**  and **Down**  buttons to scan through the alphanumeric values.
- Press **Clear** to clear the entire value. See the Graphic below for a shortcut to **Alpha Keys**

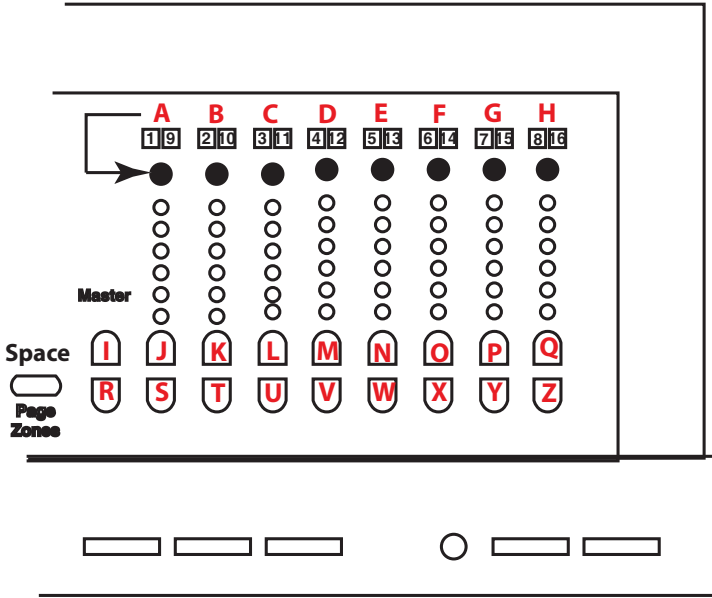

Figure 12 - Shortcut for Alpha Keys

- Step 7:** Press the **Select/Save** button to save the value and edit the label.
- Step 8:** Select another Zone or Scene to edit, or press the **Menu/Cancel** button twice to exit this menu.

Excluding Zones From a Scene

Your device allows for the specific exclusion of a zone from a scene. This means that when the scene is recalled, the levels of the excluded zone will be left exactly where they were at before the scene was recalled.

To Exclude a zone from a Scene:

OVERVIEW



QUICK START

SETUP

OPERATION

CONFIGURATION

Step 1: Press the **Menu/Cancel** button.





Step 2: Press the **Up**  and **Down**  buttons until **EDIT EXCLUDES?** flashes on the LCD display.

Step 3: Press the **Select/Save** button. The LCD changes to:

**EXCLUDE: SELECT
A SCENE TO EDIT**

Step 4: Choose a preset scene from preset/scene buttons, remote presets; IR or Entry Station. The LCD changes to (assuming you pressed the preset scene 1):

**SCENE 01
M01 - - - - - P01**

Step 5: Press the Zone **Up**  to *exclude* a zone and the Zone **Down**  button to *include* a zone. When you press a Zone **Up**  button, the corresponding "-" changes to a digit which represents the least significant *digit* of the affected zone's ID (Example: Zone 16 is represented by 6, 25 is represented by a 5). Alternately, when you press a Zone **Down**  button the "*digit*" returns to a dash ("-") meaning the zone is *included*.

6: Use **Page Zones** button to select up to 4 pages of zones. Page 1 is zones 1 to 8, page 2 is zones 9 to 16, page 3 is zones 17 to 24, page 4 is zones 25 to 32.

- Use *Clear* to clear all "excludes" i.e. to include all zones. By default all zones are included.

Preventing Changes - LOCKS

The D4200 has two types of Locks:

- **Record Lock** - Record Lock prevents any data stored in the station's memory from being altered. You must enter the Record Lock code when recording Scenes and editing any data.
- **Station Lock** - Station Lock restricts access to the controller. You must enter the Station Lock Code when recording Scenes and editing any data. Setting the Station Lock also sets the Record Lock. When you turn the Station Lock OFF, The Record Lock stays ON.

Setting the Record Lock Code

The Record Lock code must be a number between 000 and 999. The default code is 000.

NOTE

Shortcut: Use a code number between 000 and 999, as the Preset - Scene buttons 1 to 8 and MAX (9) and OFF (0) can be used to enter the code in directly.

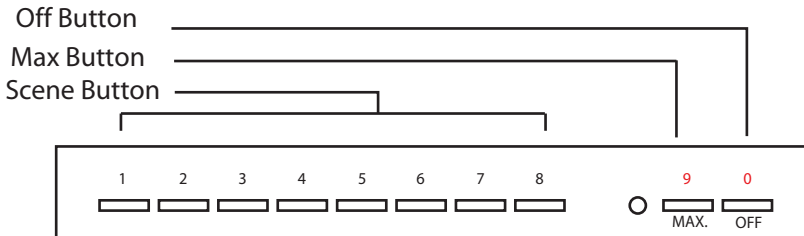

Figure 13 - Shortcut Buttons

To set the Record Lock code:

Step 1: Press the **Menu/Cancel** button.

Step 2: Press the **Up**  and **Down**  buttons until **SET RECORD LOCK?** flashes on the LCD display.

OVERVIEW

QUICK START

SETUP

OPERATION

CONFIGURATION

Step 3: Press the **Select/Save** button.

- *The CODE field flashes*

Step 4: Press the **Up**  and **Down**  buttons to change the value.

- *Note: Press **Clear** to reset the value to 000.*

Step 5: Press the **Select/Save** button to save the value.

- *SET RECORD LOCK? flashes again.*

Step 6: Press the **Menu/Cancel** button to exit this menu.

Setting the Station Lock Code

The Station Lock Code must be a number between 000 and 999. The default code is 000.

NOTE

Shortcut: Use a code number between 000 and 999, as the Preset - Scene buttons 1 to 8 and MAX (9) and OFF (0) can be used to enter the code directly.

To set the station lock code:

Step 1: Press the **Menu/Cancel** button.

Step 2: Press the **Up**  and **Down**  buttons until **SET STATION LOCK** flashes on the LCD display.

Step 3: Press the **Select/Save** button.

- *The CODE Field flashes*

Step 4: Press the **Up**  and **Down**  buttons to change the value.

- *Press **Clear** to reset the value to 000.*

Step 5: Press the **Select/Save** button to save the value.

Step 6: **SET STATION LOCK?** flashes again.





Step 7: Press the **Menu/Cancel** button to exit this menu.

Enabling the Record Lock

NOTE

Be sure to set the Record Lock code before enabling the Record Lock.





To enable or disable the Record Lock:

- Step 1:** Press the **Menu/Cancel** button.
- Step 2:** Press the **Up**  and **Down**  buttons until **RECORD LOCK=** flashes on the LCD display.
- Step 3:** Press the **Select/Save** button.
 • *The current value flashes.*
- Step 4:** Press the **Up**  and **Down**  buttons to change the value.
 • *Press **Clear** to change the value to OFF.*
- Step 5:** Press the **Select/Save** button to save the value.
 • *RECORD LOCK= flashes again.*
- Step 6:** Press the **Menu/Cancel** button to exit this menu.

Enabling the Station Lock**NOTE**

Be sure to set the Station Lock Code before enabling the Station Lock.



To enable or disable the Station Lock:

- Step 1:** Press the **Menu/Cancel** button.
- Step 2:** Press the **Up**  and **Down**  buttons until **STATION LOCK=** flashes on the LCD display.
- Step 3:** Press the **Select/Save** button.
 • *The current value flashes.*
- Step 4:** Press the **Up**  and **Down**  buttons to change the value.
 • *Press **Clear** to change the value to OFF.*
- Step 5:** Press the **Select/Save** button to save the value.
 • *STATION LOCK= flashes again.*
- Step 6:** Press the **Menu/Cancel** button to exit this menu.

Overriding a Lock

If the control station is locked by a code number, the LCD displays **ENTER CODE** when a locked operation is attempted.

To override a lock:

- Step 1:** Press the **Up**  and **Down**  buttons to enter the programmed code number (000-999).
- Press **Clear** to begin entering numbering from zero (0).

NOTE

Shortcut: Use a code number between 000 and 999, as the Preset - Scene buttons 1 to 8 and MAX (9) and OFF (0) can be used to enter the code directly.

- Step 2:** Press the **Select/Save** button to enter the value.
- *The originally selected operation begins and the unit remains unlocked for approximately 5 minutes.*

NOTE

The PIN 6 key lock input on the Luma-Net connector always locks the station overriding the station lock and there is no "Pass Code" to override this lock.

Scheduled Events



Your device can be programmed for up to 64 possible Events, numbered E01 through E64. An event consists of any of the following functions:

- Recall Scenes
- Recall Max or Off
- Start/Stop/Resume Sequencer
- Goto a sequence step
- Enable/Disable a photocell connected to an NPC or a-2000

Creating & Editing Scheduled Events

To edit the schedule:



Step 1: Press the **Menu/Cancel** button.

Step 2: Press the **Up**  and **Down**  buttons until **EDIT SCHEDULE?** flashes on the LCD display.



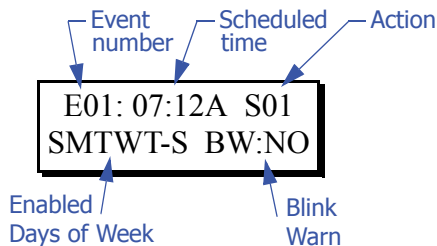

Step 3: Press the **Select/Save** button.

- *The current Event number flashes.*
- *Scheduled Events are displayed in the following form:*



Step 4: Press the **Up**  and **Down**  buttons to scan through the possible Events.

Step 5: Press the **Select/Save** button to select the Event you want to edit.

Step 6: Use **Left**  **Right**  buttons to move between fields on the screen, and **Up**  **Down**  buttons to change the values.

- **Schedule Time** is the time at which this event will occur.
 - Set to Time of day, or,

OVERVIEW



QUICK START

SETUP

OPERATION

CONFIGURATION

- Set to +SS/-SS to choose on offset time before or after sunset
 - Set to +SR/-SR to choose an offset time before or after sunrise
 - **Action** is what will occur:
 - None
 - Seq. Step - Starts a Sequence at a particular step
 - Cell ON - Photocell option on at the a-2000 dimmer rack
 - Resume - Resumes the Sequencer
 - Seq OFF - Sequencer Off
 - Seq ON - Sequencer On
 - OFF - Press the OFF button
 - MAX - Press the MAX button
 - S01.....S16 - Press a Scene button
 - Note: Press **Clear** to return the value to **NONE**. Setting the Erasing a Scene effectively erases the Event.
 - **Days of Week** - determines on what days of week this event will trigger. One position for each of the 7 days of the week:
 - Day of week listed, i.e. 'M' for Monday indicates that the event will occur on that day
 - Day of week absent, i.e. '-' for Monday indicates that the event will not occur on that day
 - **Blink Warn** - indicates whether or not a blink warn will be triggered for this event. A blink warn is simply a brief off/on of the lights indicating that values are about to change. Usually blink warns are only used to signal that lights are about to turn off. The user can then override the blink warn by pressing any key. See page 40 for additional settings which affect the operation of Blink Warns, and see page 29 which discusses disabling blink warn for a particular dimmer
- Step 7:** Press the **Select/Save** button to save these values for the Event.
- *The Event number flashes again.*

Step 8: Press the **Up**  and **Down**  buttons to select another Event and repeat all steps until all Events have been programmed.

Step 9: Press the **Menu/Cancel** button when you are finished editing events.

- *You return to the **VIEW SCHEDULE?** menu command.*



NOTE

The LCD display times out and returns to **MANUAL MODE** if no changes are made for 60 seconds.

Enabling the Scheduler

To enable or disable the scheduler:

Step 1: Press the **Menu/Cancel** button.

Step 2: Press the **Up**  and **Down**  buttons until **SCHEDULER=** flashes on the LCD display.

Step 3: Press the **Select/Save** button.

- *The current status of the scheduler flashes.*

Step 4: Press the **Up**  and **Down**  buttons to change the value.



Step 5: Press the **Select/Save** button to save the value.

Step 6: Press the **Menu/Cancel** button to exit this menu.

Viewing Scheduled Events

To view currently scheduled Events:

Step 1: Press the **Menu/Cancel** button.

Step 2: Press the **Up**  and **Down**  buttons until **VIEW SCHEDULE?** flashes on the LCD display.

Step 3: Press the **Select/Save** button.

- *Scheduled Events are displayed in the same format as for editing above.*

Sequencer

The sequencer causes Scenes to be activated in a timed sequence. The sequence may be programmed to run once or continuously in a loop. The sequence can be activated manually (preset/scene buttons) or by the event timer (scheduler). The

OVERVIEW

QUICK START

SETUP

OPERATION



CONFIGURATION

sequence can be sub-divided into groups of events simply by the use of commands that start it (GOTO a specific step).

Editing the Sequencer

To edit the sequencer:

Step 1: Press the **Menu/Cancel** button.



Step 2: Press the **Up**  and **Down**  buttons until **EDIT SEQUENCER?** flashes on the LCD display.

Step 3: Press the **Select/Save** button.

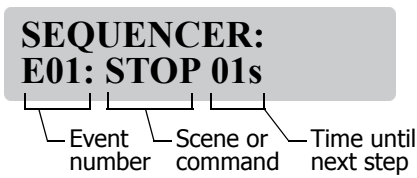
- *The Event number flashes.*
- *The sequence Events are displayed in the following format:*



- **STOP** indicates the end of the sequence and the sequencer is disabled after a **STOP** Event is executed.
- **LOOP** indicates the sequencer will immediately restart the sequence and will run continuously.
- Events after a **START** or **LOOP** command are not executed.

Step 4: Press the **Up**  and **Down**  buttons to scan through the possible Events.

Step 5: Press the **Select/Save** button to select an Event.

Step 6: Press the **Up**  and **Down**  buttons to change the value.

- *Note: Press **Clear** to change the value to **SKIP**.*

- STOP
- LOOP
- GOTO _ _
- SKIP
- Scene (With Delay Time)
- MAX

- OFF

Step 7: For the following types, Scene, Max and OFF, you must also set a delay time. Press the **Left** ◀ and **Right** ▶ buttons to highlight a Delay time.

Step 8: Press the **Up** ▲ and **Down** ▼ buttons to change the value.

Step 9: Press **Select/Save** to save the value.

Step 10: Repeat Steps 4-9 for each Sequence you wish to program.

Step 11: Press the **Menu/Cancel** button to exit this menu.

NOTE

The "SKIP" control command is a way to insert a "place holder" or "no operation" when you want to temporarily exclude some other scene or control command... then put it back at a later time.

Enabling the Sequencer

The sequence can be started and stopped either from the operational level menus, "Enabling the Sequencer" on page 51, or, from a sequencer command station for which information can be found on our product data sheets.

Viewing the Sequence

The sequencer causes Scenes to be activated in a timed sequence. The sequence may be programmed to run once or continuously in a loop. The sequence can be activated manually (preset/scene buttons) or by the event timer (scheduler). The sequence can be sub-divided into groups of events simply by the use of commands that start it (GOTO a specific step).

To view the sequencer:

Step 1: Press the **Menu/Cancel** button.

Step 2: Press the **Up** ▲ and **Down** ▼ buttons until **VIEW SEQUENCER?** flashes on the LCD display.

Step 3: Press the **Select/Save** button.

- *The Event number flashes.*
- *The sequence Events are displayed in the following format:*

OVERVIEW

QUICK START

SETUP



OPERATION

CONFIGURATION

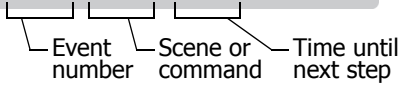
SEQUENCER: E01: OFF 01s



- **STOP** indicates the end of the sequence and the sequencer is disabled after a **STOP** Event is executed.
- **LOOP** indicates the sequencer will immediately restart the sequence and will run continuously. Events after a **START** or **LOOP** command are not executed.

Step 4: Press the **Up**  and **Down**  buttons to scan through the possible Events.

Step 5: Press the **Menu/Cancel** button to exit this menu.

System Layout Charts

The tables and charts in this section are designed to help you with the layout and configuration of your system. They are very helpful when conceptualizing how all components will interact. Included are the following charts:

- Zone to Network Channel Patch
- Network Channel to Dimmer Patch
- Scene programming
- Scheduling
- Sequencer Configuration

OVERVIEW**QUICK START****SETUP****OPERATION****CONFIGURATION**

Table - A1 - Zone Labels and Network Channels Form

Zone	Zone Label	Network Channel (or group)
1		
2		
3		
4		
5		
6		
7		
8		
9		
10		
11		
12		
13		
14		
15		
16		
17		
18		
19		
20		
21		
22		
23		
24		
25		
26		
27		
28		
29		
30		
31		
32		

Table - A2 - Dimmer Configuration

Dimmer 1:

Type: Standard MarkX Tu-Wire Non-Dim

Network Channel: _____

Groups A: _____ B: _____ C: _____ D: _____

Max: _____ Min: _____ Cutoff: _____ BW: _____

OVERVIEW

Dimmer 2:

Type: Standard MarkX Tu-Wire Non-Dim

Network Channel: _____

Groups A: _____ B: _____ C: _____ D: _____

Max: _____ Min: _____ Cutoff: _____ BW: _____

QUICK START

Dimmer 3:

Type: Standard MarkX Tu-Wire Non-Dim

Network Channel: _____

Groups A: _____ B: _____ C: _____ D: _____

Max: _____ Min: _____ Cutoff: _____ BW: _____

SETUP

Dimmer 4:

Type: Standard MarkX Tu-Wire Non-Dim

Network Channel: _____

Groups A: _____ B: _____ C: _____ D: _____

Max: _____ Min: _____ Cutoff: _____ BW: _____

OPERATION

Dimmer 5:

Type: Standard MarkX Tu-Wire Non-Dim

Network Channel: _____

Groups A: _____ B: _____ C: _____ D: _____

Max: _____ Min: _____ Cutoff: _____ BW: _____

Dimmer 6:

Type: Standard MarkX Tu-Wire Non-Dim

Network Channel: _____

Groups A: _____ B: _____ C: _____ D: _____

Max: _____ Min: _____ Cutoff: _____ BW: _____

CONFIGURATION

Table - A3 - Scene Labels and excludes

Scene	Scene Label	Excluded Zones
1		
2		
3		
4		
5		
6		
7		
8		
9		
10		
11		
12		
13		
14		
15		
16		

Table - A4 - Scheduled Events

Event #	Time	Days of Week SMTWTFS	Action*	Blink Warn (Y or N)
1				
2				
3				
4				
5				
6				
7				
8				
9				
10				
11				
12				
13				
14				
15				
16				
Up to 64 events, continue on add'l sheet				

OVERVIEW

QUICK START

SETUP

OPERATION

CONFIGURATION

* Actions can be: Scene #, Max, Off, Seq. on, Seq. Off, Resume, Cell On

Table - A5 - Sequencer Setup

Seq Step #	Action*	Delay	Seq Step #	Action*	Delay
1			17		
2			18		
3			19		
4			20		
5			21		
6			22		
7			23		
8			24		
9			25		
10			26		
11			27		
12			28		
13			29		
14			30		
15			31		
16			32		
Up to 64 events, continue on add'l sheet					

* Actions can be: Scene #, Max, Off, Skip, Loop, Stop, or Goto Step #

Latitude & Longitude Chart

<u>State/City</u>	<u>Lat.</u>	<u>Long.</u>
<u>ALABAMA</u>		
Alexander City	33° N	86° W
Anniston AP	34° N	86° W
Auburn	33° N	85° W
Birmingham AP	34° N	87° W
Decatur	35° N	87° W
Dothan AP	31° N	85° W
Florence AP	35° N	88° W
Gadsden	34° N	86° W
Huntsville AP	35° N	87° W
Mobile AP	31° N	88° W
Mobile Co	31° N	88° W
Montgomery AP	32° N	86° W
Selma-Craig AFB	02° N	88° W
Talladega	33° N	86° W
Tuscaloosa AP	33° N	88° W
<u>ALASKA</u>		
Anchorage AP	61° N	150° W
Barrow (S)	71° N	157° W
Fairbanks AP(S)	65° N	148° W
Juneau AP	58° N	135° W
Kodiak	58° N	152° W
Nome AP	64° N	165° W
<u>ARIZONA</u>		
Douglas AP	31° N	110° W
Flagstaff AP	35° N	112° W
Fort Huachuca AP (S)	32° N	110° W
Kingman AP	35° N	114° W
Nogales	31° N	111° W
Phoenix AP (S)	33° N	112° W
Prescott AP	35° N	112° W
<u>State/City</u>		
Tucson AP (S)	32° N	111° W
Winslow AP	35° N	111° W
Yuma AP	33° N	115° W
<u>ARKANSAS</u>		
Blytheville AFB	36° N	90° W
Camden	34° N	93° W
El Dorado AP	33° N	93° W
Fayetteville AP	36° N	94° W
Fort Smith AP	35° N	94° W

OVERVIEW

QUICK START

SETUP

OPERATION

CONFIGURATION

<u>State/City</u>	<u>Lat.</u>	<u>Long.</u>
Hot Springs	34° N	93° W
Jonesboro	36° N	91° W
Little Rock AP (S)	5° N	92° W
Pine Bluff AP	34° N	92° W
Texarkana AP	33° N	94° W

CALIFORNIA

Bakersfield AP	35° N	119° W
Barstow AP	35° N	117° W
Blythe AP	34° N	115° W
Burbank AP	34° N	118° W
Chico	40° N	122° W
Concord	38° N	122° W
Covina	34° N	118° W
Crescent City AP	42° N	125° W
Downey	34° N	118° W
El Cajon	33° N	117° W
El Cerrito AP (S)	33° N	116° W
Escondido	33° N	117° W
Eureka/Arcata AP	41° N	124° W
Fairfield-Travis AFB	38° N	122° W
Fresno AP (S)	37° N	120° W
Hamilton AFB	38° N	122° W
Laguna Beach	34° N	118° W
Livermore	38° N	122° W
Lompoc, Vandenberg AFB	35° N	121° W
Long Beach AP	34° N	118° W
Los Angeles AP (S)	34° N	118° W
Los Angeles CO (S)	34° N	118° W
Merced-Castle AFB	37° N	121° W
Modesto	38° N	121° W
Monterey	37° N	122° W
Napa	38° N	122° W
Needles AP	35° N	115° W
Oakland AP	38° N	122° W
Oceanside	33° N	117° W
Ontario	34° N	118° W
Oxnard	34° N	119° W
Palmdale AP	35° N	118° W
Palm Springs	34° N	117° W
Pasadena	34° N	118° W
Petaluma	38° N	123° W
Pomona Co	34° N	118° W
Redding AP	41° N	122° W
Redlands	34° N	117° W
Richmond	38° N	122° W
Riverside-March AFB (S)	34° N	117° W
Sacramento AP	39° N	121° W
Salinas AP	37° N	122° W

San Bernadino, Norton AFB	34° N	117° W
<u>State/City</u>	<u>Lat.</u>	<u>Long.</u>
San Diego AP	33° N	117° W
San Fernando	34° N	118° W
San Francisco AP	38° N	122° W
San Francisco Co	38° N	122° W
San Jose AP	37° N	122° W
San Louis Obispo	35° N	121° W
Santa Ana AP	34° N	118° W
Santa Barbara MAP	34° N	120° W
Santa Cruz	37° N	122° W
Santa Maria AP (S)	35° N	120° W
Santa Monica CIC	34° N	118° W
Santa Paula	34° N	119° W
Santa Rosa	39° N	123° W
Stockton AP	38° N	121° W
Ukiah	39° N	123° W
Visalia	36° N	119° W
Yreka	42° N	123° W
Yuba City	39° N	122° W

COLORADO

Alamosa AP	37° N	106° W
Boulder	40° N	105° W
Colorado Springs AP	39° N	105° W
Denver AP	40° N	105° W
Durango	37° N	108° W
Fort Collins	41° N	105° W
Grand Junction AP (S)	39° N	109° W
Greeley	40° N	105° W
Lajunta AP	38° N	103° W
Leadville	39° N	106° W
Pueblo AP	38° N	104° W
Sterling	48° N	103° W
Trinidad	37° N	104° W

CONNECTICUT

Bridgeport AP	41° N	73° W
Hartford, Brainard Field	42° N	73° W
New Haven AP	41° N	74° W
New London	41° N	72° W
Norwalk	41° N	73° W

<u>State/City</u>	<u>Lat.</u>	<u>Long.</u>
Norwick	42° N	72° W
Waterbury	42° N	73° W
Widsor Locks, Bradley Fl	42° N	73° W

OVERVIEW

QUICK START

SETUP

OPERATION

CONFIGURATION

<u>State/City</u>	<u>Lat.</u>	<u>Long.</u>
<u>DELAWARE</u>		
Dover AFB	39° N	75° W
Wilmington AP	40° N	76° W

<u>DISTRICT OF COLUMBIA</u>		
Andrews AFB	38° N	76° W
Washington, National AP	39° N	77° W

<u>FLORIDA</u>		
Belle Glade	27° N	81° W
Cape Kennedy AP	28° N	81° W
Daytona Beach AP	29° N	81° W
E Fort Lauderdale	26° N	80° W
Fort Myers AP	27° N	82° W
Fort Pierce	27° N	80° W
Gainesville AP (S)	30° N	82° W
Jacksonville AP	30° N	82° W
Key West AP	25° N	82° W
Lakeland Co (S)	28° N	82° W
Miami AP (S)	26° N	80° W
Miami Beach Co	26° N	80° W
Ocala	29° N	82° W
Orlando AP	29° N	81° W
Panama City, Tyndall AFB	30° N	86° W
Pensacola Co	30° N	87° W
St. Augustine	30° N	81° W
St. Petersburg	28° N	83° W
Stanford	29° N	81° W
Sarasota	27° N	83° W
Tallahassee AP (S)	30° N	84° W
Tampa AP (S)	28° N	83° W
West Palm Beach AP	27° N	80° W

<u>GEORGIA</u>		
Albany, Turner AFB	32° N	84° W
Americus	32° N	84° W
Athens	33° N	83° W
Atlanta AP (S)	34° N	84° W
Augusta AP	33° N	82° W
Brunswick	31° N	81° W
Columbus, Lawson AFB	33° N	85° W
Dalton	35° N	85° W
Dublin	32° N	83° W
Gainesville	34° N	84° W
Griffin	33° N	84° W
LaGrange	33° N	85° W
Macon AP	33° N	84° W
Marietta, Dobbins AFB	34° N	85° W
Savannah	32° N	81° W

<u>State/City</u>	<u>Lat.</u>	<u>Long.</u>
Valdosta-Moody AFB	31° N	83° W
Waycross	31° N	82° W
<u>HAWAII</u>		
Hilo AP (S)	20° N	155° W
Honolulu AP	21° N	158° W
Kaneohe Bay MCAS	21° N	158° W
Wahiawa	21° N	158° W
<u>IDAHO</u>		
Boise AP (S)	44° N	116° W
Burley	43° N	114° W
Coeur D'Alene AP	48° N	117° W
Idaho Falls AP	44° N	112° W
Lewiston AP	46° N	117° W
Moscow	47° N	117° W
Mountain Home AFB	43° N	116° W
Pocatello AP	43° N	113° W
Twin Falls AP (S)	42° N	114° W
<u>ILLINOIS</u>		
Aurora	42° N	88° W
Belleville, Scott AFB	39° N	90° W
Bloomington	40° N	89° W
Carbondale	38° N	89° W
Champaign/Urbana	40° N	88° W
Chicago, Midway AP	42° N	88° W
Chicago, O'Hare AP	42° N	88° W
Chicago Co	42° N	88° W
Danville	40° N	88° W
Decatur	40° N	89° W
Dixon	42° N	89° W
Elgin	42° N	88° W
Freeport	42° N	90° W
Galesburg	41° N	90° W
Greenville	39° N	89° W
Joliet	42° N	88° W
Kankakee	41° N	88° W
La Salle/Peru	41° N	89° W
Macomb	40° N	91° W
Moline AP	41° N	91° W
Mt Vernon	38° N	89° W
Peoria AP	41° N	90° W
Quincy AP	40° N	91° W
Rantoul, Chanute AFB	40° N	88° W
Rockford	42° N	89° W
Springfield AP	40° N	90° W
Waukegan	42° N	88° W

OVERVIEW

QUICK START

SETUP

OPERATION

CONFIGURATION

<u>State/City</u>	<u>Lat.</u>	<u>Long.</u>
<u>INDIANA</u>		
Anderson	40° N	86° W
Bedford	39° N	86° W
Bloomington	39° N	87° W
Columbus, Bakalar AFB	39° N	86° W
Crawfordsville	40° N	87° W
Evansville AP	38° N	88° W
Fort Wayne AP	41° N	85° W
Goshen AP	42° N	86° W
Hobar	42° N	87° W
Huntington	41° N	85° W
Indianapolis AP	40° N	86° W
Jeffersonville	38° N	86° W
Kokomo	40° N	86° W
Lafayette	40° N	86° W
La Porte	42° N	87° W
Marion	40° N	86° W
Muncie	40° N	85° W
Peru, Grissom AFB	41° N	86° W
Richmond AP	40° N	85° W
Shelbyville	40° N	86° W
South Bend AP	42° N	86° W
Terre Haute AP	39° N	87° W
Valparaiso	42° N	87° W
Vincennes	39° N	88° W
<u>IOWA</u>		
Ames (S)	42° N	94° W
Burlington AP	41° N	91° W
Cedar Rapids AP	42° N	92° W
Clinton	42° N	90° W
Council Bluffs	41° N	96° W
Des Moines AP	42° N	94° W
Dubuque	42° N	91° W
Fort Dodge	43° N	95° W
Iowa City	42° N	92° W
Keokuk	40° N	91° W
Marshalltown	42° N	93° W
Mason City AP	43° N	93° W
Newton	42° N	93° W
Ottumwa AP	41° N	92° W
Sioux City AP	42° N	96° W
Waterloo	43° N	92° W
<u>KANSAS</u>		
Atchison	40° N	95° W
Chanute AP	38° N	95° W
Dodge City AP (S)	38° N	100° W
El Dorado	38° N	97° W
Emporia	38° N	96° W

<u>State/City</u>	<u>Lat.</u>	<u>Long.</u>
Garden City AP	38° N	101° W
Goodland AP	39° N	102°W
Great Bend	38° N	99° W
Hutchinson AP	38° N	98° W
Libera	37° N	101° W
Manhattan, Ft Riley (S)	39° N	97° W
Parsons	37° N	96° W
Russell AP	39° N	99° W
Salina	39° N	98° W
Topeka AP	39° N	96° W
Wichita AP	38° N	97° W
 <u>KENTUCKY</u>		
Ashland	39° N	83° W
Bowling Green AP	36° N	86° W
Corbin AP	37° N	84° W
Covington AP	39° N	85° W
Hopkinsville, Ft Campbell	37° N	88° W
Lexington AP (S)	38° N	85° W
Louisville AP	38° N	86° W
Madisonville	37° N	87° W
Owensboro	38° N	87° W
Paducah AP	37° N	89° W
 <u>LOUISIANA</u>		
Alexandria AP	31° N	92° W
Baton Rouge AP	31° N	91° W
Bogalusa	31° N	90° W
Houma	30° N	91° W
Lafayette AP	30° N	92° W
Lake Charles AP (S)	30° N	93° W
Minden	33° N	93° W
Monroe AP	33° N	92° W
Natchitoches	32° N	93° W
New Orleans AP	30° N	90° W
Shreveport AP (S)	32° N	94° W
 <u>MAINE</u>		
Augusta AP	44° N	70° W
Bangor, Dow AFB	45° N	69° W
Caribou AP (S)	47° N	68° W
Lewiston	44° N	70° W
Millinocket AP	46° N	69° W
Portland (S)	44° N	70° W
Waterville	45° N	70° W

OVERVIEW

QUICK START

SETUP

OPERATION

CONFIGURATION

<u>State/City</u>	<u>Lat.</u>	<u>Long.</u>
<u>MARYLAND</u>		
Baltimore AP	39° N	77° W
Baltimore Co	39° N	76° W
Cumberland	40° N	79° W
Frederick AP	40° N	78° W
Hagerstown	40° N	78° W
Salisbury (S)	38° N	75° W

MASSACHUSETTS

Boston AP	42° N	71° W
Clinton	42° N	72° W
Fall River	42° N	71° W
Framingham	42° N	71° W
Gloucester	43° N	71° W
Greenfield	42° N	72° W
Lawrence	43° N	71° W
Lowell	43° N	71° W
New Bedford	42° N	71° W
Pittsfield AP	42° N	73° W
Springfield, Westover AFB	42° N	73° W
Taunton	42° N	71° W
Worcester AP	42° N	72° W

MICHIGAN

Adrian	42° N	84° W
Alpena AP	45° N	83° W
Battle Creek AP	42° N	85° W
Benton Harbor AP	42° N	86° W
Detroit	42° N	83° W
Escanaba	46° N	87° W
Flint AP	43° N	84° W
Grand Rapids AP	43° N	86° W
Holland	43° N	86° W
Jackson AP	42° N	84° W
Kalamazoo	42° N	86° W
Lansing AP	43° N	85° W
Marquette Co	47° N	87° W
Mt Pleasant	44° N	85° W
Muskegon AP	43° N	86° W
Pontiac	43° N	83° W
Port Huron	43° N	82° W
Saginaw AP	44° N	84° W
Sault Ste. Marie AP (S)	46° N	84° W
Traverse City AP	45° N	86° W
Ypsilanti	42° N	84° W

MINNESOTA

Albert Lea	44° N	93° W
Alexandria AP	46° N	95° W

<u>State/City</u>	<u>Lat.</u>	<u>Long.</u>
Bemidji AP	48° N	95° W
Brainerd	47° N	94° W
Duluth AP	47° N	92° W
Faribault	44° N	93° W
Fergus Falls	46° N	96° W
International Falls AP	49° N	93° W
Mankato	44° N	93° W
Minneapolis/St. Paul AP	45° N	94° W
Rochester AP	44° N	92° W
St. Cloud AP (S)	46° N	94° W
Virginia	47° N	92° W
Willmar	45° N	93° W
Winona	44° N	92° W

MISSISSIPPI

Biloxi—Keesler AFB	30° N	89° W
Clarksdale	34° N	91° W
Columbus AFB	33° N	88° W
Greenville AFB	34° N	91° W
Greenwood	33° N	90° W
Hattiesburg	31° N	89° W
Jackson AP	32° N	90° W
Laurel	31° N	89° W
Mccomb AP	32° N	90° W
Meridian AP	32° N	89° W
Natchez	32° N	91° W
Tupelo	34° N	89° W
Vicksburg Co	32° N	91° W

MISSOURI

Cape Girardeau	37° N	90° W
Columbia AP (S)	39° N	92° W
Farmington AP	38° N	90° W
Hannibal	40° N	91° W
Jefferson City	39° N	92° W
Joplin AP	37° N	94° W
Kansas City AP	39° N	95° W
Kirksville AP	40° N	93° W
Mexico	39° N	92° W
Moberly	39° N	92° W
Poplar Bluff	37° N	90° W
Rolla	38° N	92° W
St. Joseph AP	40° N	95° W
St. Louis AP	39° N	90° W
St. Louis CO	39° N	91° W
Sikeston	37° N	90° W
Sedalia—Whiteman AFB	39° N	94° W
Sikeston	37° N	90° W
Springfield AP	37° N	93° W

OVERVIEW

QUICK START

SETUP

OPERATION

CONFIGURATION

<u>State/City</u>	<u>Lat.</u>	<u>Long.</u>
<u>MONTANA</u>		
Billings AP	46° N	109° W
Bozeman	46° N	111° W
Butte AP	46° N	112° W
Cut Bank AP	49° N	112° W
Glasgow AP (S)	48° N	107° W
Glendive	47° N	105° W
Great Falls AP (S)	47° N	111° W
Havre	49° N	110° W
Helena AP	47° N	112° W
Kalispell AP	48° N	114° W
Lewiston AP	47° N	109° W
Livingstown AP	46° N	110° W
Miles City AP	46° N	106° W
Missoula AP	47° N	114° W

<u>NEBRASKA</u>		
Beatrice	40° N	97° W
Chadron AP	43° N	103° W
Columbus	41° N	97° W
Fremont	41° N	96° W
Grand Island AP	41° N	98° W
Hastings	41° N	98° W
Kearney	41° N	99° W
Lincoln Co (S)	41° N	97° W
McCook	40° N	101° W
Norfolk	42° N	97° W
North Platte AP (S)	41° N	101° W
Omaha AP	41° N	96° W
Scottsbluff AP	42° N	104° W
Sidney AP	41° N	103° W

<u>NEVADA</u>		
Carson City	39° N	120° W
Elko AP	41° N	116° W
Ely AP (S)	39° N	115° W
Las Vegas AP (S)	36° N	115° W
Lovelock AP	40° N	119° W
Reno AP (S)	39° N	120° W
Reno Co	39° N	120° W
Tonopah AP	38° N	117° W
Winnemucca AP	41° N	118° W

<u>NEW HAMPSHIRE</u>		
Berlin	44° N	71° W
Claremont	43° N	72° W
Concord AP	43° N	71° W
Keene	43° N	72° W
Laconia	43° N	71° W

<u>State/City</u>	<u>Lat.</u>	<u>Long.</u>
Manchester, Grenier AFB	43° N	71° W
Portsmouth, Pease AFB	43° N	71° W

NEW JERSEY

Atlantic City CO	39° N	74° W
Long Branch	40° N	74° W
Newark AP	41° N	74° W
New Brunswick	40° N	74° W
Paterson	41° N	74° W
Phillipsburg	41° N	75° W

<u>State/City</u>	<u>Lat.</u>	<u>Long.</u>
Trenton Co	40° N	75° W
Vineland	39° N	75° W

NEW MEXICO

Holloman AFB	33° N	106° W
Albuquerque AP (S)	35° N	107° W
Artesia	33° N	104° W
Carlsbad AP	32° N	104° W
Clovis AP	34° N	103° W
Farmington AP	37° N	108° W
Gallup	36° N	109° W
Grants	35° N	108° W
Hobbs AP	33° N	103° W
Las Cruces	32° N	107° W
Los Alamos	36° N	106° W
Raton AP	37° N	104° W
Roswell, Walker AFB	33° N	105° W
Santa Fe CO	36° N	106° W
Silver City AP	33° N	108° W
Socorro AP	34° N	107° W
Tucumcari AP	35° N	104° W

NEW YORK

Albany AP (S)	43° N	74° W
Albany Co	43° N	74° W
Auburn	43° N	77° W
Batavia	43° N	78° W
Binghamton AP	42° N	76° W
Buffalo AP	43° N	79° W
Cortland	43° N	76° W
Dunkirk	42° N	79° W
Elmira AP	42° N	77° W
Geneva (S)	43° N	77° W
Glens Falls	43° N	74° W
Gloversville	43° N	74° W
Hornell	42° N	78° W
Ithaca (S)	42° N	76° W

OVERVIEW

QUICK START

SETUP

OPERATION

CONFIGURATION

<u>State/City</u>	<u>Lat.</u>	<u>Long.</u>
Jamestown	42° N	79° W
Kingston	42° N	74° W
Lockport	43° N	79° W
Massena AP	45° N	75° W
Newburgh, Stewart AFB	41° N	74° W
NYC-Central Park (S)	41° N	74° W
NYC-Kennedy AP	41° N	74° W
NYC-La Guardia AP	41° N	74° W
Niagara Falls AP	43° N	80° W
Olean	42° N	79° W
Oneonta	43° N	75° W
Oswego Co	43° N	77° W
Plattsburg AFB	45° N	73° W
Poughkeepsie	42° N	74° W
Rochester AP	43° N	78° W
Rome, Griffiss AFB	43° N	75° W
Schenectady (S)	43° N	74° W
Suffolk County AFB	41° N	73° W
Syracuse AP	43° N	76° W
Utica	43° N	75° W
Watertown	44° N	76° W

NORTH CAROLINA

Asheville AP	35° N	83° W
Charlotte AP	35° N	81° W
Durham	36° N	79° W
Elizabeth City AP	36° N	76° W
Fayetteville, Pope AFB	35° N	79° W
Goldsboro, Seymour-Johnson	35° N	78° W
Greensboro AP (S)	36° N	80° W
Greenville	36° N	77° W
Henderson	36° N	78° W
Hickory	06° N	81° W
Jacksonville	35° N	78° W
Lumberton	35° N	79° W
New Bern AP	35° N	77° W
Raleigh/Durham AP (S)	36° N	79° W
Rocky Mount	36° N	78° W
Wilmington AP	34° N	78° W
Winston-Salem AP	36° N	80° W

NORTH DAKOTA

Bismarck AP (S)	47° N	101° W
Devils Lake	48° N	99° W
Dickinson AP	47° N	103° W
Fargo AP	47° N	97° W
Grand Forks AP	48° N	97° W
Jamestown AP	47° N	99° W
Minot AP	48° N	101° W
Williston	48° N	104° W

<u>State/City</u>	<u>Lat.</u>	<u>Long.</u>
<u>OHIO</u>		
Akron-Canton AP	41° N	81° W
Ashtabula	42° N	81° W
Athens	39° N	82° W
Bowling Green	41° N	84° W
Cambridge	40° N	82° W
Chillicothe	39° N	83° W
Cincinnati Co	39° N	85° W
Cleveland AP (S)	41° N	82° W
Columbus AP (S)	40° N	83° W

<u>State/City</u>	<u>Lat.</u>	<u>Long.</u>
Dayton AP	40° N	84° W
Defiance	41° N	84° W
Findlay AP	41° N	84° W
Fremont	41° N	83° W
Hamilton	39° N	85° W
Lancaster	40° N	83° W
Lima	41° N	84° W
Mansfield AP	41° N	83° W
Marion	41° N	83° W
Middletown	40° N	84° W
Newark	40° N	82° W
Norwalk	41° N	83° W
Portsmouth	39° N	83° W
Sandusky Co	41° N	83° W
Springfield	40° N	84° W
Steubenville	40° N	81° W
Toledo AP	42° N	84° W
Warren	41° N	81° W
Wooster	41° N	82° W
Youngstown AP	41° N	81° W
Zanesville AP	40° N	82° W

<u>State/City</u>	<u>Lat.</u>	<u>Long.</u>
<u>OKLAHOMA</u>		
Ada	35° N	97° W
Altus AFB	35° N	99° W
Ardmore	34° N	97° W
Bartlesville	37° N	96° W
Chickasha	35° N	98° W
Enid, Vance AFB	36° N	98° W
Lawton AP	35° N	98° W
McAlester	35° N	96° W
Muskogee AP	36° N	95° W
Norman	35° N	97° W
Oklahoma City AP (S)	35° N	98° W
Ponca City	37° N	97° W
Seminole	35° N	97° W
Stillwater (S)	36° N	97° W

OVERVIEW

QUICK START

SETUP

OPERATION

CONFIGURATION

<u>State/City</u>	<u>Lat.</u>	<u>Long.</u>
Tulsa AP	36° N	96° W
Woodward	37° N	100° W

OREGON

Albany	45° N	123° W
Astoria AP (S)	46° N	124° W
Baker AP	45° N	118° W
Bend	44° N	121° W
Corvallis (S)	44° N	123° W
Eugene AP	44° N	123° W
Grants Pass	42° N	123° W
Klamath Falls AP	42° N	122° W
Medford AP (S)	42° N	123° W
Pendleton AP	46° N	119° W
Portland AP	46° N	123° W
Portland Co	46° N	123° W
Roseburg AP	43° N	123° W
Salem AP	45° N	123° W
The Dalles	46° N	121° W

PENNSYLVANIA

Allentown AP	41° N	75° W
Altoona Co	40° N	78° W
Butler	41° N	80° W
Chambersburg	40° N	78° W
Erie AP	42° N	80° W
Harrisburg AP	40° N	77° W
Johnstown	40° N	79° W
Lancaster	40° N	76° W
Meadville	42° N	80° W
New Castle	41° N	80° W
Philadelphia AP	40° N	75° W
Pittsburgh AP	40° N	80° W
Pittsburgh Co	40° N	80° W
Reading Co	40° N	76° W
Scranton/Wilkes-Barre	41° N	76° W
State College (S)	41° N	78° W
Sunbury	41° N	77° W
Uniontown	40° N	80° W
Warren	42° N	79° W
West Chester	40° N	76° W
Williamsport AP	41° N	77° W
York	40° N	77° W

RHODE ISLAND

Newport (S)	41° N	71° W
Providence AP	42° N	71° W

<u>State/City</u>	<u>Lat.</u>	<u>Long.</u>
<u>SOUTH CAROLINA</u>		
Anderson	34° N	83° W
Charleston AFB (S)	33° N	80° W
Charleston Co	33° N	80° W
Columbia AP	34° N	81° W
Florence AP	35° N	80° W
Georgetown	33° N	79° W
Greenville AP	35° N	82° W
Greenwood	35° N	82° W
Orangeburg	33° N	81° W
Rock Hil	35° N	81° W
Spartanburg AP	35° N	82° W
Sumter, Shaw AFB	34° N	80° W

<u>State/City</u>	<u>Lat.</u>	<u>Long.</u>
<u>SOUTH DAKOTA</u>		
Aberdeen AP	45° N	98° W
Brookings	44° N	97° W
Huron AP	44° N	98° W
Mitchell	44° N	98° W
Pierre AP	44° N	100° W
Rapid City AP (S)	44° N	103° W
Sioux Falls AP	44° N	97° W
Watertown AP	45° N	97° W
Yankton	43° N	97° W

<u>TENNESSEE</u>		
Athens	35° N	85° W
Bristol-Tri City AP	36° N	82° W
Chattanooga AP	35° N	85° W
Clarksville	37° N	87° W
Columbia	36° N	87° W
Dyersburg	36° N	89° W
Greenville	36° N	83° W
Jackson AP	36° N	89° W
Knoxville AP	36° N	84° W
Memphis AP	35° N	90° W
Murfreesboro	35° N	86° W
Nashville AP (S)	36° N	87° W
Tullahoma	35° N	86° W

<u>TEXAS</u>		
Abilene AP	32° N	100° W
Alice AP	28° N	98° W
Amarillo AP	35° N	101° W
Austin AP	30° N	98° W
Bay City	29° N	96° W
Beaumont	30° N	94° W
Beeville	28° N	98° W

OVERVIEW

QUICK START

SETUP

OPERATION

CONFIGURATION

<u>State/City</u>	<u>Lat.</u>	<u>Long.</u>
Big Spring AP (S)	32° N	101° W
Brownsville AP (S)	26° N	97° W
Brownwood	32° N	99° W
Bryan AP	31° N	97° W
Corpus Christi AP	28° N	97° W
Corsicana	32° N	96° W
Dallas AP	33° N	97° W
Del Rio, Laughlin AFB	29° N	101° W
Denton	33° N	97° W
Eagle Pass	29° N	101° W
El Paso AP (S)	32° N	106° W
Fort Worth AP (S)	33° N	97° W
Galveston AP	29° N	95° W
Greenville	33° N	96° W
Harlingen	26° N	98° W

<u>State/City</u>	<u>Lat.</u>	<u>Long.</u>
Houston AP	30° N	95° W
Houston Co	30° N	95° W
Huntsville	31° N	96° W
Killeen, Robert Gray AAF	31° N	98° W
Lamesa	33° N	102° W
Laredo AFB	28° N	99° W
Longview	32° N	95° W
Lubbock AP	34° N	102° W
Lufkin AP	31° N	95° W
McAllen	26° N	98° W
Midland AP (S)	32° N	102° W
Mineral Wells AP	33° N	98° W
Palestine Co	32° N	96° W
Pampa	36° N	101° W
Pecos	31° N	103° W
Plainview	30° N	94° W
Goodfellow AFB	31° N	100° W
San Antonio AP (S)	30° N	98° W
Sherman, Perrin AFB	34° N	97° W
Snyder	33° N	101° W
Temple	31° N	97° W
Tyler AP	32° N	95° W
Vernon	34° N	99° W
Victoria AP	29° N	97° W
Waco AP	32° N	97° W
Wichita Falls AP	34° N	98° W

<u>UTAH</u>		
Cedar City AP	38° N	113° W
Logan	42° N	112° W
Moab	39° N	110° W
Ogden AP	41° N	112° W

<u>State/City</u>	<u>Lat.</u>	<u>Long.</u>
Price	40° N	111° W
Provo	40° N	112° W
Richfield	39° N	112° W
St George Co	37° N	114° W
Salt Lake City AP (S)	41° N	112° W
Vernal AP	40° N	110° W

VERMONT

Barre	44° N	73° W
Burlington AP (S)	44° N	73° W
Rutland	44° N	73° W

VIRGINIA

Charlottesville	38° N	79° W
Danville AP	37° N	79° W
Fredericksburg	38° N	77° W
Harrisonburg	38° N	79° W
Lynchburg AP	37° N	79° W

<u>State/City</u>	<u>Lat.</u>	<u>Long.</u>
Norfolk AP	37° N	76° W
Petersburg	37° N	78° W
Richmond AP	37° N	77° W
Roanoke AP	37° N	80° W
Staunton	38° N	79° W
Winchester	39° N	78° W

WASHINGTON

Aberdeen	47° N	124° W
Bellingham AP	49° N	123° W
Bremerton	48° N	123° W
Ellensburg AP	47° N	121° W
Everett, Paine AFB	48° N	122° W
Kennewick	46° N	119° W
Longview	46° N	123° W
Moses Lake, Larson AFB	47° N	119° W
Olympia AP	47° N	123° W
Port Angeles	48° N	123° W
Seattle-Boeing Field	48° N	122° W
Seattle Co (S)	48° N	122° W
Seattle-Tacoma AP (S)	47° N	122° W
Spokane AP (S)	48° N	118° W
Tacoma, McChord AFB	47° N	122° W
Walla Walla AP	46° N	118° W
Wenatchee	47° N	120° W
Yakima AP	47° N	121° W

OVERVIEW

QUICK START

SETUP

OPERATION

CONFIGURATION

<u>State/City</u>	<u>Lat.</u>	<u>Long.</u>
<u>WEST VIRGINIA</u>		
Beckley	38° N	81° W
Bluefield AP	37° N	81° W
Charleston AP	38° N	82° W
Clarksburg	39° N	80° W
Elkins AP	39° N	80° W
Huntington Co	38° N	82° W
Martinsburg AP	39° N	78° W
Morgantown AP	40° N	80° W
Parkersburg Co	39° N	82° W
Wheeling	40° N	81° W

<u>WISCONSIN</u>		
Appleton	44° N	88° W
Ashland	47° N	91° W
Beloit	42° N	89° W
Eau Claire AP	45° N	91° W
Fond Du Lac	44° N	88° W
Green Bay AP	44° N	88° W
La Crosse AP	44° N	91° W
Madison AP (S)	43° N	89° W
Manitowoc	44° N	87° W

<u>State/City</u>	<u>Lat.</u>	<u>Long.</u>
Marinette	45° N	88° W
Milwaukee AP	43° N	88° W
Racine	43° N	88° W
Sheboygan	44° N	88° W
Stevens Point	44° N	90° W
Waukesha	43° N	88° W
Wausau AP	45° N	90° W

<u>WYOMING</u>		
Casper AP	43° N	106° W
Cheyenne	41° N	105° W
Cody AP	45° N	109° W
Evanston	41° N	111° W
Lander AP (S)	43° N	109° W
Laramie AP (S)	41° N	106° W
Newcastle	44° N	104° W
Rawlins	42° N	107° W
Rock Springs AP	42° N	109° W
Sheridan AP	45° N	107° W
Torrington	42° N	104° W

Warranty Information

Leviton Manufacturing Co Inc. warrants its Dimmer Systems and Controls to be free of material and workmanship defects for a period of two years after system acceptance or 26 months after shipment, whichever comes first. This Warranty is limited to repair or replacement of defective equipment returned Freight Pre-Paid to Leviton Lighting Control Division at 20497 Teton Ave., Tualatin, Oregon 97062, USA. User shall call 1-800-959-6004 and request a return authorization number to mark on the outside of the returning carton, to assure that the returned material will be properly received at Leviton. All equipment shipped back to Leviton must be carefully and properly packed to avoid shipping damage. Replacements or repaired equipment will be returned to sender freight prepaid, F.O.B. factory. Leviton is not responsible for removing or replacing equipment on the job site, and will not honor charges for such work. Leviton will not be responsible for any loss of use time or subsequent damages should any of the equipment fail during the warranty period, but agrees only to repair or replace defective equipment returned to its plant in Tualatin, Oregon. This Warranty is void on any product that has been improperly installed, overloaded, short circuited, abused, or altered in any manner. Neither the seller nor Leviton shall be liable for any injury, loss or damage, direct or consequential arising out of the use of or inability to use the equipment. This Warranty does not cover lamps, ballasts, and other equipment which is supplied or warranted directly to the user by their manufacturer. Leviton makes no warranty as to the Fitness for Purpose or other implied Warranties.

FCC Compliance Statement

This device complies with the Class A limits of part 15 of the FCC rules. These limits are designed to provide reasonable protection against harmful interference when the equipment is operated in a commercial environment. This device generates, uses, and can radiate radio frequency energy. If not installed & used in accordance with the instruction manual, this device may cause harmful interference to radio communications. Operation of this in a residential area is likely to cause harmful interference in which the user will be required to correct the interference at his own expense.



Leviton Lighting & Energy Solutions Division
20497 SW Teton Avenue, Tualatin, OR 97062
Customer Service Telephone: 1-800-736-6682 • FAX: 1-503-404-5600
Tech Line: 1-800-959-6004

Leviton Manufacturing Co., Inc.
201 N. Service Rd. Melville, NY 11747-3138
Telephone: 1-800-323-8920 • FAX: 1-800-832-9538

Visit Leviton's Web site at www.leviton.com/les
© 2013 Leviton Manufacturing Co., Inc. All Rights Reserved
Specifications and Pricing Subject to Change at any time

PK-93390-10-00-0C
10/2013

