

**TANNOY**<sup>®</sup>  
NORTH AMERICA INC.

***Proton***

Nearfield Monitor

# Reference Manual

Tannoy North America Inc.  
335 Gage Ave., Suite #1 Kitchener, Ontario Canada N2M 5E1  
Tel:(519)745-1158 Fax:(519)745-2364 Toll Free Dealer Faxline:(800)525-7081  
e-mail: [inquiries@tannoyna.com](mailto:inquiries@tannoyna.com)

**[www.tannoy.com](http://www.tannoy.com)**

## **1.0 INTRODUCTION**

## **2.0 THE BASICS**

- 2.1 Unpacking and visual checks
- 2.2 Preliminary recommendation
- 2.3 Connecting your speakers
- 2.4 Observing polarity
- 2.5 Power Amplifiers

## **3.0 PLACEMENT OF THE SPEAKERS**

- 3.1 Orientation
- 3.2 Positioning
- 3.3 Console Reflections
- 3.4 Speaker Mounting
- 3.5 Bass Ports
- 3.6 Equalization

## **4.0 PERFORMANCE DATA**

## **5.0 TECHNICAL SPECIFICATIONS**

## **6.0 SERVICING**

- 6.1 Cabinet finish
- 6.2 Driver removal
- 6.3 Crossover
- 6.4 List of spare parts

## **7.0 WARRANTY**

Tannoy North America Inc.  
335 Gage Ave., Suite #1 Kitchener, Ontario Canada N2M 5E1  
Tel:(519)745-1158 Fax:(519)745-2364 Toll Free Dealer Faxline:(800)525-7081  
e-mail: [inquiries@tannoyna.com](mailto:inquiries@tannoyna.com)

**[www.tannoy.com](http://www.tannoy.com)**

# *D Proto J*

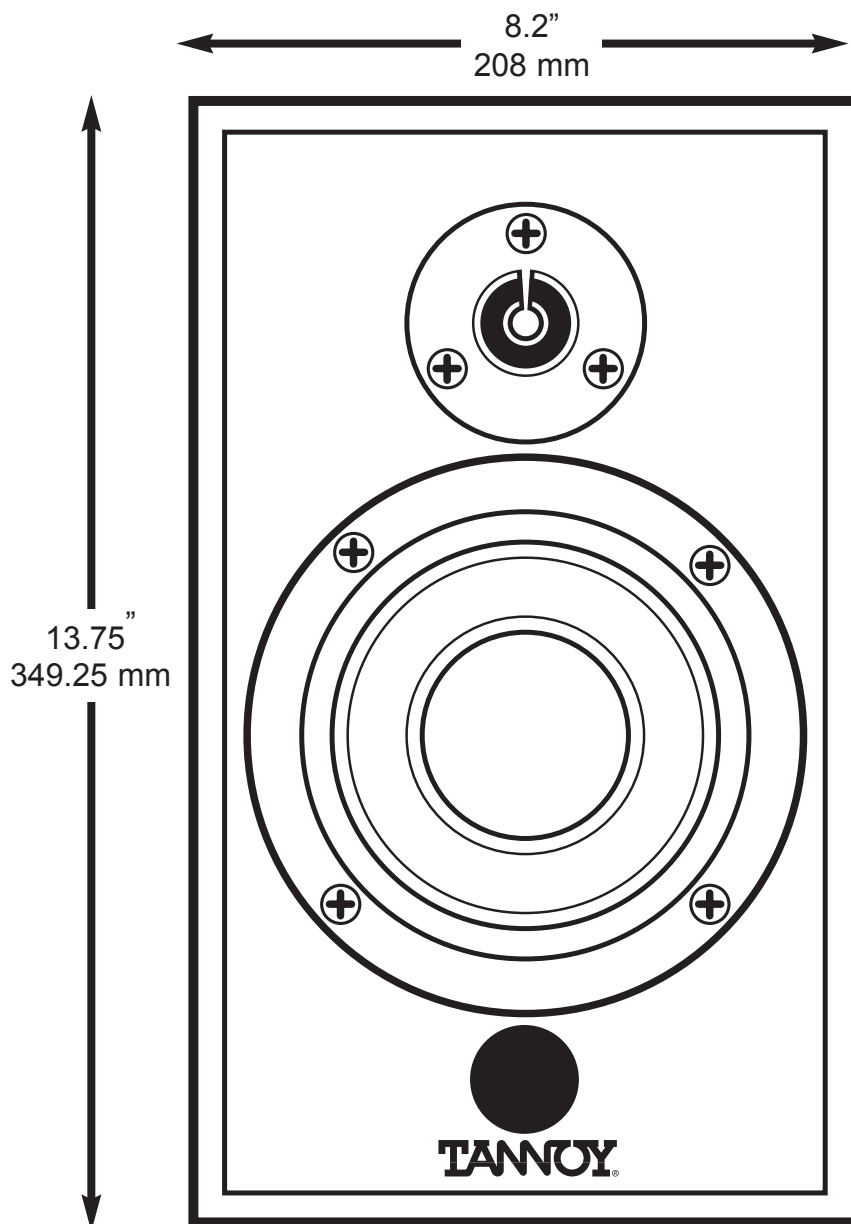

## 1.0 INTRODUCTION

You're thinking, "Come on, a user's manual for speakers? That's like a user's manual for a toothbrush." You know enough not to plug your speakers into an AC outlet, and you know you should hook them up in phase and then you listen to them. How much more do you need to know? We know these speakers are headed for the professional or semi-professional studio market, so we know we don't need to tell you about putting your potted plants on top of the speakers, or to avoid putting the right one on the bookshelf, and the left one on the floor behind the sofa. We know you are serious listeners or you wouldn't have bought Tannoy monitors. We decided that someone needed to produce this type of manual, and because we're actually interested in monitoring, not just speaker sales, we figured it would have to be us. This user's manual will tell you how to get the absolute best performance out of your new monitors.

## 2.0 THE BASICS

The Proto-J is the latest playback monitor from Tannoy, a company with unrivalled experience in studio monitoring. It has an extremely detailed, dynamic sound with a wide, flat frequency response – all of which are essential for monitoring with reliable accuracy.

The 1/2" (12.5 mm) soft dome HF unit is seamlessly matched to a 6.5" (165 mm) long throw bass unit by the precision low loss crossover network. The drive units are discretely mounted on a 3/4" (18.5 mm) MDF baffle. The front edges of the vented enclosure are chamfered to reduce high frequency diffraction. The back panel features two 5-way binding post inputs and integral inserts to accommodate Omni Mount™ 50 Series wall brackets to accommodate wall mounting for easy and flexible 5.1 surround sound installs. Proto-J is designed to blend seamlessly with the Tannoy PS110B 5.1 Subwoofer to complete this package.

Don't put potted plants on top of your speakers, don't plug them into AC outlets, or hook them up out of phase. Now that we've got that out of the way, let's talk about some of the technical things to keep in mind.

### ***2.1 Unpacking and visual checks***

To remove the speakers from the carton without damage open the end flaps fully and bend them right back (remember they are packed in pairs). Turn the package upside-down on the floor and lift the carton vertically up to leave the speakers resting on their packing tray. Nothing on or in your speakers should rattle about. Inspect each speaker for signs of transit damage. In the unlikely event of this having occurred inform the carrier and the supplier. Keep all the packaging if damage has occurred, as this will show evidence of excessive handling forces. It is also a good idea to keep the carton if possible for future transportation.

### ***2.2 Preliminary recommendation***

Initially we would like to give a word of warning on high sound levels, which these speakers are capable of generating over sustained periods of time. Levels over 95 dB for 8 hours per day will eventually cause permanent hearing loss. Because Tannoy monitors have very low levels of time, amplitude and frequency distortion it is not always obvious that the sound level is high while working with them.

For continuous exposure we recommend the occasional use of a sound level meter capable of integrating the sound level over a period of exposure according to noise control standards. This should be used just to check that noise levels are always within safety limits.

### **2.3 Connecting your speakers**

The types of cable used to connect the speakers to the power amplifier will marginally affect the sound. The cross-sectional area of the cable should be large enough so as not to affect the damping factor, generally a cable with a cross-sectional area of 2.5 mm<sup>2</sup>, or greater is recommended. The lower the resistance of the cable between the amplifier and the speakers, the better the damping factor acting on the speaker. This has been covered in every audio magazine that has ever been written about speakers, so we won't beat it to death here. You don't need to buy speaker wire that costs as much as your speakers to get some benefit from wire size, select a finely stranded speaker cable, and dress the cable ends to prevent "hairs" or stray conductors from shorting across the terminals. If your amplifier will not directly accept that size of cable, you can trim down the cable size at the amplifier end. Ensure that the binding post retaining nuts are screwed down firmly without stripping or over tightening them.

### **2.4 Observing polarity**

You already know about connecting the positive terminal on the amplifier to the positive terminal on the speakers, and ensuring that both channels are "in phase" by checking to ensure that there's more bass with both speakers on and not less bass. Absolute polarity is a bit trickier to confirm. Absolute polarity is the maintenance of a positive pressure wave from the microphone capsule to the listening room. A kick drum, for instance, has the drum skin whacked by the foot pedal, and it pushes the air, which pushes the microphone diaphragm, which goes through the electronics and should eventually come out of the speakers as a positive pressure wave, which should have the speaker cones moving towards you, just like the drum skin. It turns out that you can't trust a conventional recorded source to test this because there is no way to confirm that absolute polarity was maintained, it can even change from track to track. This isn't a trivial thing, especially when you're using a true stereo microphone setup, or trying to accurately place things in your mix. This is something that should be rigorously checked with every microphone and every signal line in a studio, but the first step would be to use the kickdrum test described above with a few microphones. If you don't believe it can make a difference, set up a little test using a mix you know and flip the polarity of both channels at the same time, while listening to the same program...imaging, vague imaging, imaging, vague imaging. Believe it.

### **2.5 Power Amplifiers**

The power amplifier should be reasonably well matched in power to the power rating of the speakers (see specifications). The use of a powerful amplifier (i.e. in excess of the recommended figure) provides headroom, which is useful especially for highly dynamic programme materials. Due of the high peak power handling of Tannoy monitors, responsible use of even more powerful amplifiers should not represent a danger to the speakers if the amplifiers are not overdriven. Now, just because you have a Ferrari, it doesn't mean to say you can drive it at the red line all of the time, it will eventually blow up. Same thing goes here, just because the speakers will handle a large amplifier, it doesn't mean that you can run them flat out constantly without eventually blowing something up.

### 3.0 PLACEMENT OF THE SPEAKERS

Now here's the truly critical stuff. Speaker placement and the listening environment can completely compromise the performance of any loudspeaker, no matter how much it costs. It is important to understand some limitations of nearfield speakers, and the operating environment, in order for you to gain the maximum performance from the pair sitting in front of you.

#### 3.1 Orientation

Two way speakers have a correct orientation for the serious listener. Two way systems use a separate woofer and tweeter mounted in a vertical line on the baffle. There is a fixed vertical distance between the centre of the two devices on the baffle, and there is fixed distance between the apparent acoustic center of each device and the plane of the baffle at the crossover point. By stacking the woofer and tweeter vertically, we minimize the problems caused by these physical offsets. The near-field listening conditions magnify the effects of the driver offsets, so we really need to optimize the speaker orientation. When you are very close to a speaker system, vertical head movements are significant because your movement represents a large change in angle of arc, and therefore the number of degrees above and below the axis (that's the line between the woofer and tweeter). In other words, bob your head up and down a few centimeters within a metre of the cabinet, and your ear moves through a larger angle relative to the speaker axis than it does with the same vertical motion 4 or 5 meters away. Need proof? Put on some music, not loud, and get really close, about 20" (500 mm) away. Move your head up and down now, and you can actually get the musical image to break into a separate high frequency and low frequency source. This is a wildly exaggerated example of what we're talking about. It isn't that bad out here in the normal listening position, but the variations are still there.

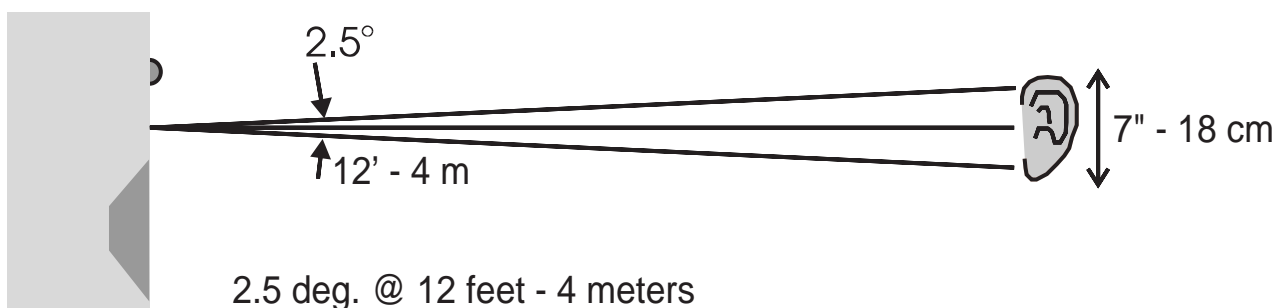
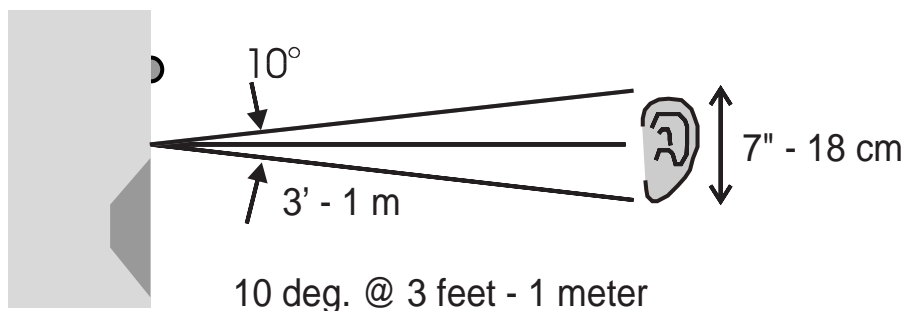

All two way component systems have to live with some listening position dependent compromises at the crossover point. The crossover frequency of all of these small systems falls into the center of the midband (2.0 kHz to 3.0 kHz), where we are most capable of recognizing frequency/phase response deviations.

In the diagrams below we have a graphical representation of the speaker systems operating at the crossover point where both high and low frequency drivers produce the same output level. The first one shows a pair of two-way loudspeakers lying on their side. Note that each driver is producing sound, and because there is a physical distance separating them on the baffle, there is also a time difference separating the drivers, and the result is what you see here. Around the crossover point, the speaker will produce numerous lobes, producing changes in midrange sound character as you move across the horizontal listening plane.

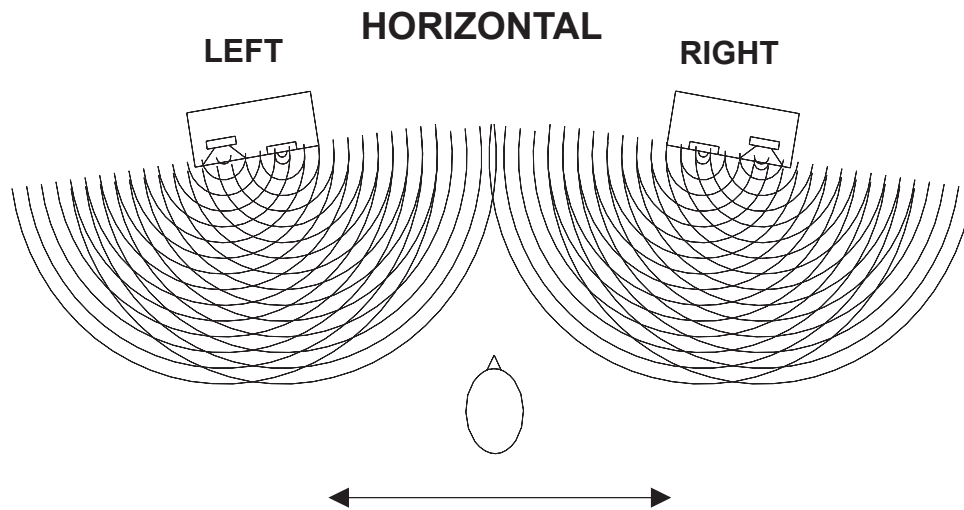

With the monitors laying horizontally, you will move through the largest number of variations caused by the physical/time offsets between the drivers, if you think this is hard to look at, imagine listening to it!

Stereo occurs from left to right, so that is the listening plane in which we try to minimise the changes in physical/time offset between the woofers and tweeters. And we have to be honest, it's not perfect, the driver offset is still there, but by stacking the woofer and tweeter vertically on the baffle we can give the mix engineer the widest range of movement in the horizontal plane. You can roll your chair across the length of your mixing console and not change the relationship between the woofer and tweeter (just don't bob your head up and down while you do it).

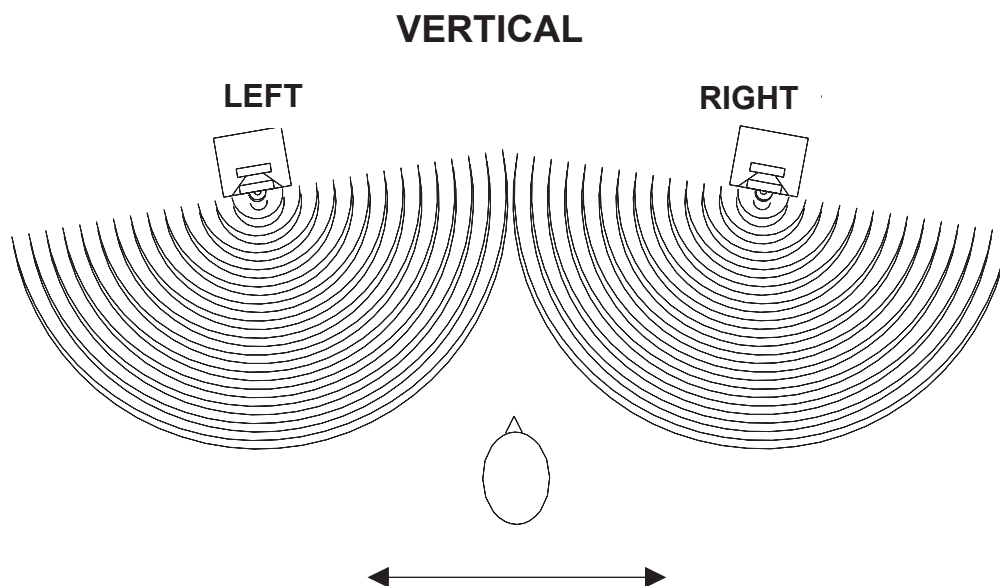

With the woofer and tweeter stacked vertically, you experience the least variation as you move across the horizontal plane of the console work surface.

Another interesting note, the Tannoy true Point Source Dual Concentric™ monitors are free from the physical offsets previously described, which means that the behavior of the Dual Concentric™ monitors will not change in the horizontal, vertical or any other plane you can pick. The other neat thing about Dual Concentric™ monitors is that no matter how close you get to them you can't get the image to fragment into separate high and low frequency sources.

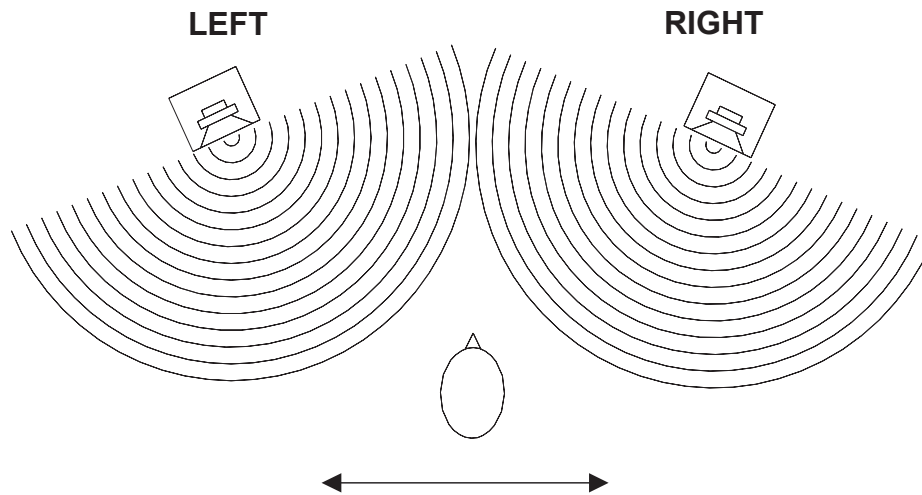

With Dual Concentric™ monitors, there are no changes in the relationship between the woofer and tweeter, you have complete vertical and horizontal freedom of movement.

Now, if you were to follow the all too common practice of lying your two way monitors on their side to give you better sight lines over your meter bridge, you can see (and hear) what will happen. With the monitor on its side, moving your head horizontally means you are now moving through all those rays, or lobes, where the wavefronts from the woofers and tweeters interfere with each other. The midrange frequency response will be different for each head position. All two way component monitors, no matter who manufactures them, need to be used with the multi-driver axis vertical (that's just the way it has to be when you're in the nearfield). And if you're wondering how three-way nearfields work with a whole bunch of speakers stuck all over the baffle, well... you'll quickly realize why we stopped at two way speaker systems.

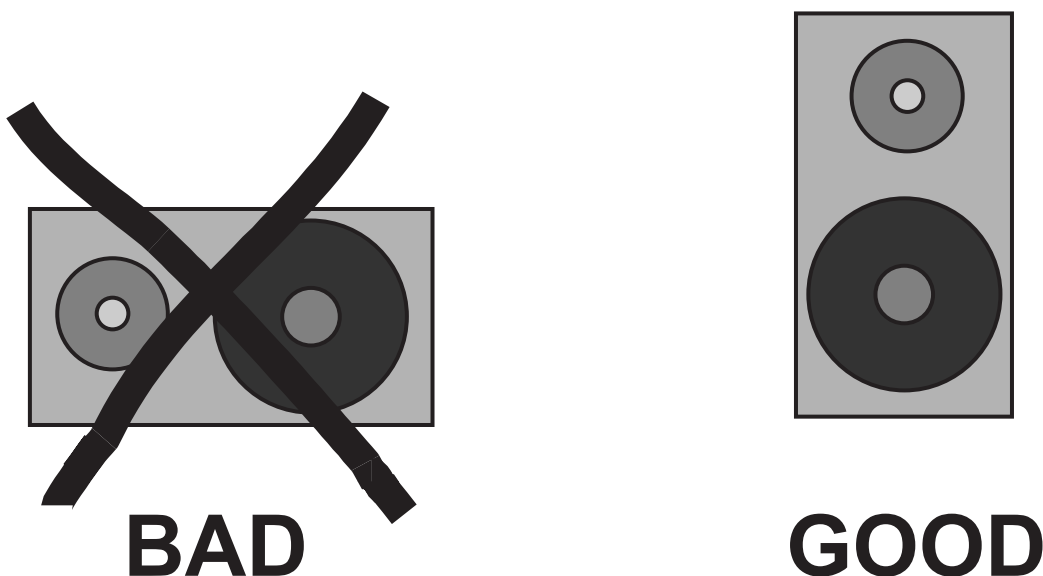

### 3.2 Positioning

This is the monitor equivalent of a wheel alignment. Where do you aim the speakers to give you the smoothest and most consistent sound, and how far apart do you place them to give you a good stereo image? The basic rule is to follow the layout of an equilateral triangle. The distance between the two monitors should be roughly the same as the distance between one monitor and your nose in the listening position where you are leaning forward on the console armrest. See the following diagram.

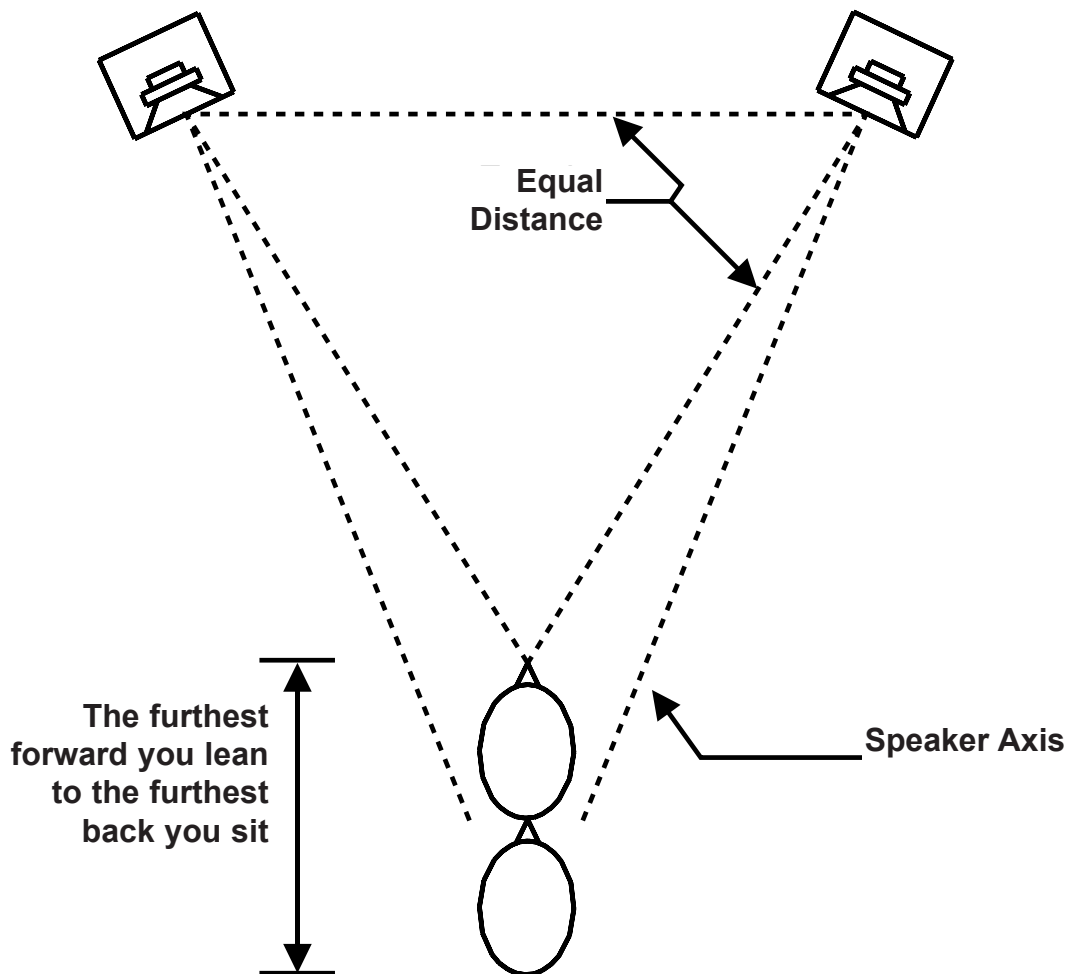

The speaker axis (shown on the diagram) should be aimed at the halfway point between your furthest forward and the furthest back listening positions (as indicated by the two heads on the diagram). This is typically a range of about 24" (600 mm). If you can, you also want to try to get your ears lined up with the vertical speaker axis (half way between the woofer and the tweeter). Remember the earlier drawings showing your ears and the speaker, these were to get your normal listening position lined up in the best spot possible. If this would have you resting your chin on the console, you could tilt the monitor back slightly. This keeps your head in the sweet spot whether you're leaning forward adjusting level or EQ, or leaning back and listening to the mix. Don't go crazy trying to get this exact to three decimal places, within a few inches will suffice. Your Tannoy monitors have a wide sweet spot both horizontally and vertically to reduce the variations in sound quality as you move around doing your recording engineer stuff. Turning the monitors in like this has an added benefit of keeping the high frequencies from reflecting off the walls and outboard gear.

### 3.3 Console Reflections

The number one killer of smooth nearfield monitor response is the mixing console. Most people park their nearfield monitors on top of the meter bridge, which makes the console top the most influential reflecting surface for the sound you hear when you're mixing. How important is that reflection? If it were such a big deal, wouldn't people have done something different by now? Let's face it, this industry is not exactly quick to acknowledge a situation that makes it apparent we've ignored a problem for the ten years or so since nearfields became popular. So you still have reservations as to the significance of this reflection? OK, dig out your pink noise generator, it's time for an experiment. You'll need an assistant from the audience for this. Have your assistant hold your monitor up in the air about 24" (600 mm) from the top of the console while feeding pink noise through it. Make sure you're listening right on the speaker axis (that line between the woofer and tweeter), and have your assistant slowly lower the monitor onto its perch on the meter bridge. Hear that change in midrange character as it gets within the last foot of the console? How different did it sound when it was up in the air. There's two significant things happening here. The first problem is comb filtering (interference) caused by the reflection from the console top taking a fraction of a second (and a tiny fraction!) longer to get to your ear than the sound directly from the speaker. And you thought you couldn't afford a Flanger for your studio. You may have noticed that in the last foot prior to touchdown on the console the main sonic change was in the midband area. There is a real cruelty associated with laws of physics, the speed of sound in air gives us wavelengths in the midrange area that just seem to coincide with the dimensions of everything we mount speakers on, maximizing the problems created by these reflections. The previous diagrams (horizontal and vertical) that show the interaction between a separate woofer and tweeter also demonstrate the problem generated by the reflection. Substitute the reflection for one of the drivers in the diagram and you've got a pretty good picture of what happens when the original wavefront and the reflected wavefront meet. The big problem with this comb filtering is that you can't fix it with any terrestrial equalizer, once the waves cancel there is nothing left to boost. You may also notice that as you move your head, the filtering changes, so any equalization you attempted to apply for one position would be detrimental to all the other listening positions.

We mentioned that there are two things happening here. The second thing is a change in directivity caused by the addition of a boundary (the console top). When you want to shout at someone outdoors you cup your hands around your mouth to increase the directivity of your voice. By placing the monitor on the meter bridge, you've done the equivalent of putting one hand to your mouth. In the lower midrange (200 - 800 Hz), where the wave length is long enough at 16" - 55" (400 mm - 1400 mm) that you don't get cancellation, you get the wave fronts adding together. This causes an increment in the level over the lower midrange area at the same time that holes appear in the midrange from comb-filtering effects. Now that you've begun to believe it is impossible to use nearfields on a console top, we'll talk about what you can do to help alleviate these problems. The first thing you need to do is be able to identify the surfaces that are close enough to do serious harm. You can do this at great expense by using a real time analyser, and spend a few months learning to use it, OR, you can grab a length of string, some gaffer tape, and a mic stand, and get set for another experiment.

First the theory. For unblemished stereo imaging and frequency response you would want to listen in a completely reflection free environment, like an anechoic chamber, where all you would hear is the image and the direct sound produced by the speakers, no nasty reflections anywhere. For most people this is impractical. Next best thing, if you can establish a listening position free of reflections arriving within 2 milliseconds after the direct sound (that's the time it takes sound to travel about 24" or 600 mm or less which represents all frequencies from 500 Hz and up), and minimize reflections arriving within 10 milliseconds of the direct sound, you can maintain a remarkably stable stereo image, and uniform response throughout the mix area. The "direct sound" is just that, it is the shortest straight-line path that sound can take from the speaker to your ear, no bounces, no reflections.

The 2 millisecond reflection window really affects the character of the sound at the mix position, drastically altering the response of the speaker in the critical audio bands of 500 Hz and above. The 10 millisecond reflection window does some more subtle things to the speaker's response, because the ear/brain reads reflections arriving within 10 milliseconds of the direct sound as being part of the speaker's response, these reflections can pull the stereo image around in different directions at different frequencies. Enough theory, now to the lab.

Here's where we have fun with science. Take the microphone stand and place it at the mix position. Attach one end of the string to the top of the mic stand, and stretch the string out to the front of one of the monitors. This is the direct sound path from the speaker to your mix position. To locate all the surfaces that will contribute reflections within that magic 2 millisecond window, add 24" (600 mm) to the string you have stretched out. Take a small piece of gaffer tape and attach the string to the baffle (NOT the drivers!). Now, every surface you can touch with any part of that string can contribute a reflection to your mix position.

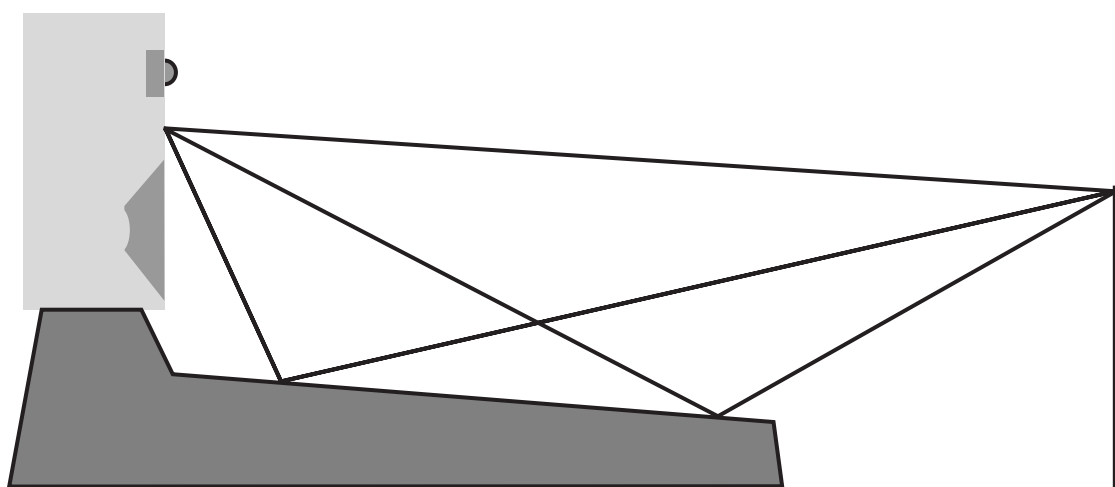

### **The STRING analyser**

This same concern about reflecting surfaces applies to all nearby widgets such as computer monitors, outboard gear, coffee cups, rolls of tape, the producer's wooden leg and all the other usual paraphernalia found in a studio environment. Cleaning up this short sound path between the speaker and your listening position is like using a cotton bud on your ear.

You can repeat the process with an extra 10' (3000mm) of string to see which surfaces will influence the timbre and imaging of your mix. This exercise is not just about finding places to stick fuzzy or foamy absorbers to, the last thing you want to do is make your room completely dead. What this process will show you is which surfaces you should try to angle to redirect reflections away from your mix position. If there are surfaces that you cannot move or shift, you can apply a small amount of absorbent material to specific surfaces, rather than covering the entire room in absorbers.

You may want to consider a speaker placement other than the console meter bridge, perhaps on an elevated mounting arm attached to the wall, or on a midfield monitor stand, just behind the console. These positions can help clean up that 2 millisecond window. Keep your ears open for other problem reflections, like between the sloped connector panel on the back of the console and the baffle of the speaker, which will find its way back to the mix position a bit too late to be useful. The string trick works just fine for locating these reflecting surfaces.

It's important that you listen to the effect of speaker placement on the sound character of your speakers, and understand what those changes are going to do to your mix. To make the point here's are some more things to consider:

### **3.4 Speaker Mounting**

You've probably got your monitors delicately balanced on your console meter bridge, or sitting on a counter top beside your hard disc editor. Find some music with some real solid low end that you know well. Try listening to this music with the speaker sitting directly on the mounting surface and then with it sitting on a thin piece of rubber pad. Hear a difference? Which one sounds more like the recording should? Does one get tubby, or muddy? Depending on the type of mounting surface, you may find it beneficial to use a thin layer of flexible material (i.e. Bluetack) beneath the enclosure. This not only absorbs some vibration, but will help prevent the monitor from vibrating off of its mounting surface.

### **3.5 Bass Ports**

The Reveal monitors' bass port is located on the back panel. You should keep the back panels at least 6" (150 mm) away from the nearest wall surface to avoid an overblown bass sound. If you cannot avoid being close to the wall or if you're using a separate subwoofer, you may want to consider plugging the port tubes on your near-fields with a closed cell foam-rubber plug, friction fit for a full seal. Because the ports aren't needed if the monitor speakers are being used with a high pass filter, you won't be losing any bass performance and you can improve the mid-bass response by plugging the ports.

### **3.6 Equalization**

Our feeling is that you shouldn't equalize monitors at all; variations in the monitor response should be fixed through placement (after all, that's what this manual's about). But we realize that equalization is sometimes a necessary evil. If you have a choice of equalizers for monitor applications, less is more. The fewer the number of filters, the better the equalizer will sound. A stereo five band parametric is better than a stereo 15 band that is better than a stereo 1/3 Octave. You may not realise that in all but one or two brands of 1/3 Octave equalizers, all 30 filters are in series. There is a minimum transit time through each filter of some 25 microseconds, plus just a bit of decay time for each filter. Even with the equalizer set flat, it does not behave like a straight piece of wire in the time domain. If you don't need to equalize your monitors, then don't hook an equalizer up to them at all.

An important thing to keep in mind if you are equalizing these compact monitors is that they are not intended to substitute for really large loudspeaker systems you might use for tracking synth lines, or drum samples. Don't try to equalize them to sound the same as the 15" monitors you were listening to in the music store. The equalization of your nearfields should be undertaken with great subtlety. With only the best intentions of correcting some of the placement related characteristics we've talked about here, a subtle bit of reduction in the mid bass where the console or table top will give you a rise, perhaps a bit of tailoring to taste here or there. As a general rule for this application, you should never need more than 6 dB of control range, and you should never see two adjacent filters with more than 6 dB of difference between them. Over equalization can reduce system headroom, and introduce phase distortion resulting in greater problems than cures.

## 4.0 PERFORMANCE DATA

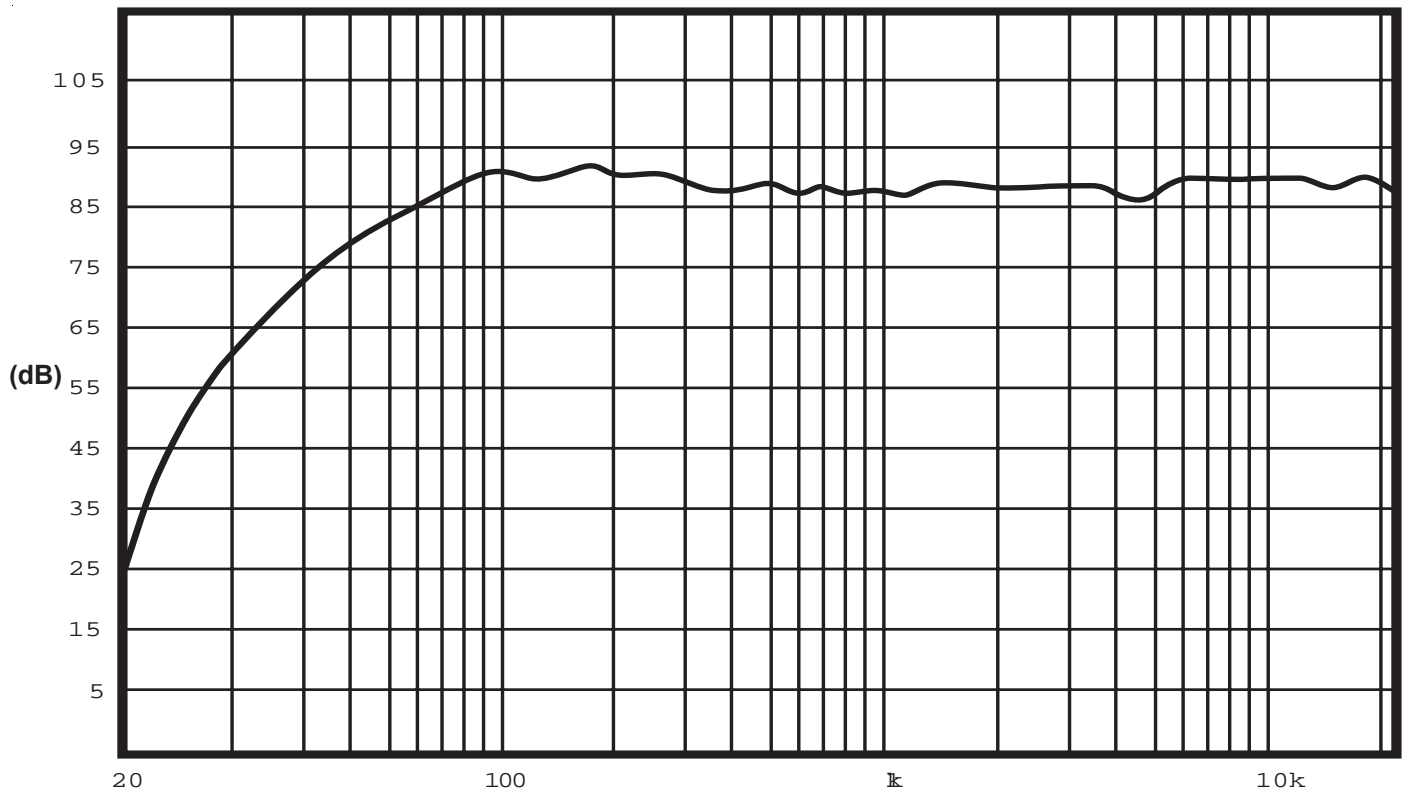
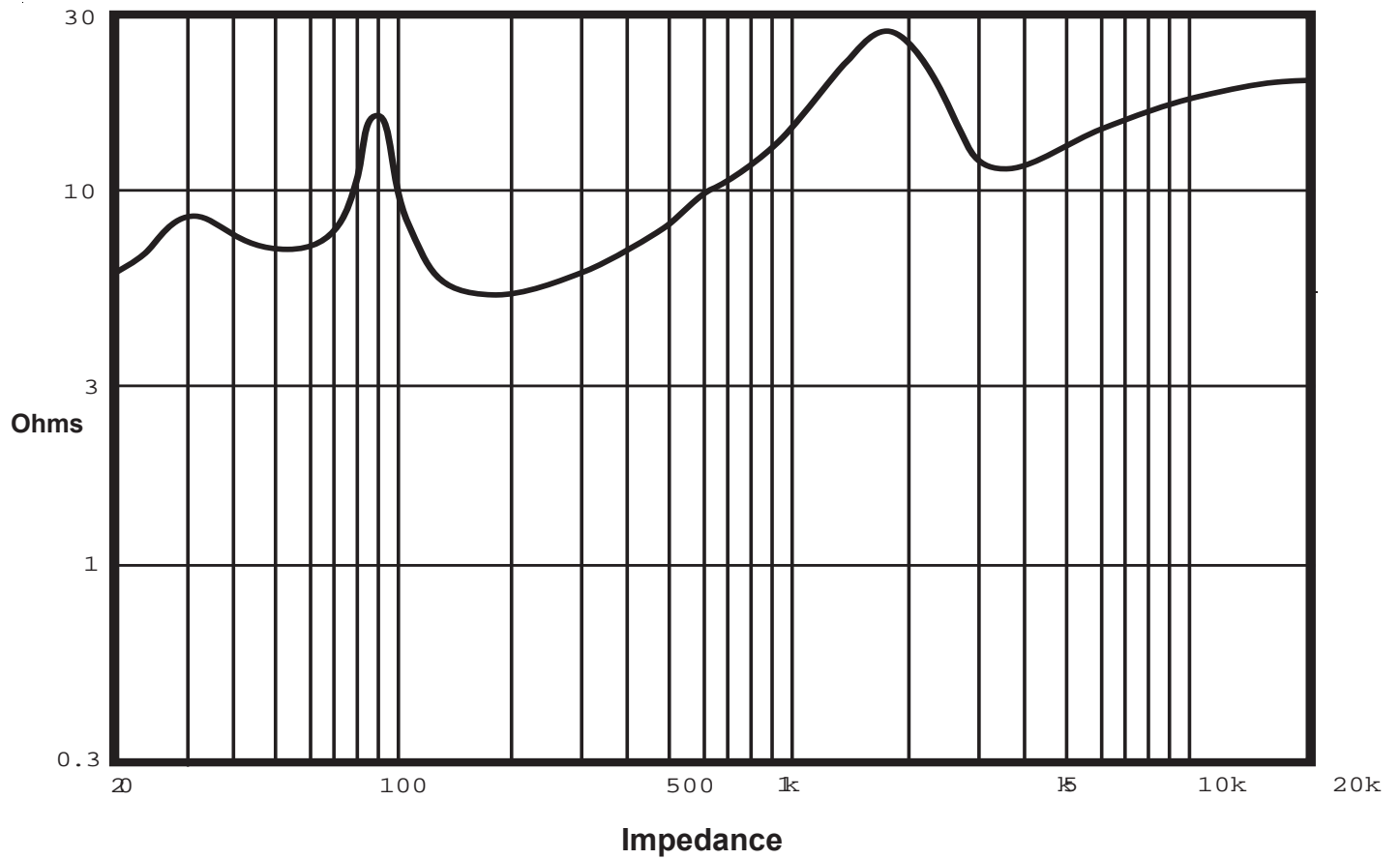

Figure 1. On axis anechoic frequency response



## 5.0 TECHNICAL SPECIFICATIONS

### Loudspeaker

Frequency response (1)	60 Hz - 20 kHz
Recommended amplifier power	50 to 100 Watts rms into 8 Watts
Power handling	Average (2)                      Programme 50 Watts rms                      100 Watts rms
Nominal Impedance	6 Ohms
Sensitivity (3)	90 dB SPL / 1 Watt @ 1 meter
Crossover frequency	3000 Hz

### Cabinet

Drive unit	Tannoy 6.5" (165 mm) bass driver Tannoy 3/4" (19 mm) soft dome tweeter
Low frequency design	Optimized bass-reflex load, in 10 litres
Cabinet construction	MDF high density particle board
Fittings	M6 x 2 Omni Mount™ 50 Series Mount
Cabinet finish	Grained Black Vinyl
Cabinet dimensions (HxWxD)	13.75" x 8.2" x 9.13" - 350 mm x 208 mm x 232 mm
Cabinet weight	4.8 lbs - 4.8 kg
Shipping dimensions (HxWxD)	12.5" x 10.3" x 20.8" - 400 mm x 260mm x 527mm
Shipping weight	24 lbs - 16 kg

**NOTES :** (1) +/- 3 dB , measured at 1 meter in an anechoic chamber.

(2) Long term power handling capacity as defined in EIA standard RS426A.

(3) Averaged over specified bandwidth for half-space environment. For anechoic conditions the figure is to be decreased by 3 dB.

Tannoy operates a policy of continuous research and development. The introduction of new materials or manufacturing methods will always equal or exceed the published specifications which Tannoy reserve the right to alter without prior notice. Please verify the latest specifications when dealing with critical applications.

## **6.0 SERVICING**

### **6.1 Cabinet finish**

To remove marks and scuffs use a soft brush. If necessary, a little warm water and detergent can be used but under no circumstances use a solvent or abrasive cleaner.

### **6.2 Driver removal**

Lay the cabinet on its back. Remove the six hexagonal screws and set aside. Ease the driver from the front of the cabinet taking care not to mark the front surface. Remove the driver, note the polarity of the internal connections and disconnect the internal wiring. Take care not to damage the moving parts of the LF driver. To refit the driver, connect the cables from the crossover to the LF terminals. Fit the driver into the mounting hole, making sure that the internal connecting cables are not trapped or able to touch the LF cone. Fasten the screws finger tight and then progressively tighten them down with the appropriate Allen key.

Repeat the same procedure for the HF driver.

### **6.3 Crossover**

The crossover is mounted on the rear of the terminal panel. To inspect it, remove the panel by releasing the hexagonal screws. Take care to avoid undue stress on the cables and components. To remove the crossover completely the cables must be disconnected from the drive unit. Please proceed as above to remove the drive unit.

### **6.4 List of spare parts.**

<b>PART NUMBER</b>	<b>DESCRIPTION</b>
5DR61084	Driver kit – LF
5DR53100	HF unit

## **7.0 WARRANTY**

No maintenance of the Proto-J monitor is necessary.

All components are guaranteed for a period of five years from the date of manufacture, subject to the absence of, or evidence of, misuse, overload or accidental damage.

For further information please contact your dealer or the distributor in your country.

If you cannot locate your distributor please contact:

Customer Services

Tannoy North America Inc.

335 Gage Ave., Suite #1 Kitchener, On Canada N2M 2C8

Telephone: (519) 745-1158 Fax: (519) 745-2364

E-mail: [inquiries@tannoyna.com](mailto:inquiries@tannoyna.com) Internet: <http://www.tannoy.com>

**DO NOT SHIP ANY PRODUCT TO TANNOY WITHOUT PREVIOUS AUTHORIZATION.**

This warranty in no way affects your statutory rights.

