



**D4**

**Digital Wireless System**



Fill in for your records:

Serial Number:

Purchase Date:





# Table of Contents

- Introduction.....3
- General Technical Description .....4
- Front and Rear Panels.....6
- Navigating the LCD .....7
- Antenna Placement and Orientation.....7
- TransmitterGeneral Settings .....8
- TransmitterAudio Trim Setup.....9
- ReceiverGeneral Settings .....10
- ReceiverAudio Level Setup .....11
- Transmitter AES3 Modes .....12
- Receiver AES3 Modes.....12
- Mixed Modes .....12
- Connector Pinouts .....12
- Frequency Selection .....13
- Finding Clear Frequencies .....13
- Parts and Accessories .....14
- Firmware Updates .....16
- Specifications .....17
- Service and Repair .....18
  - Returning Units for Repair .....18

## Introduction

The D4 digital wireless system was designed as a special purpose system for location production in film and television.

A typical application for this system is in television production as part of what is commonly called a “bag system.” A portable mixer and several wireless microphone receivers are carried in an over-shoulder carrying case. The D4T transmitter is connected to the outputs of the mixer to transmit up to four audio channels to one or more D4R receivers mounted on video cameras.

The system is designed for line level analog audio signals and AES/EBU digital audio signals with options that provide:

- Digital in/Digital out
- Digital in/Analog out
- Analog in/Digital out
- Analog in/Analog out

The system can be configured to provide either 2 or 4 audio channels. In the 4-channel mode, four different bands may be selected as shown below. Each frequency carries four audio channels, digitally multiplexed on a common carrier. In the 2-channel mode, eight different frequencies are available as shown below, each with two audio channels.

Multiple D4 systems can be operated in the same location to provide up to 16 audio channels.

The audio quality is suitable for any professional application in film, television and live sound. 48kHz/24-bit audio, ruler-flat 20Hz to 20kHz frequency response, ultra-low distortion and high dynamic range assure excellent audio quality.

Housings and panels are machined aluminum with electrostatic powder coated and anodized finishes and laser etched marking for durability.

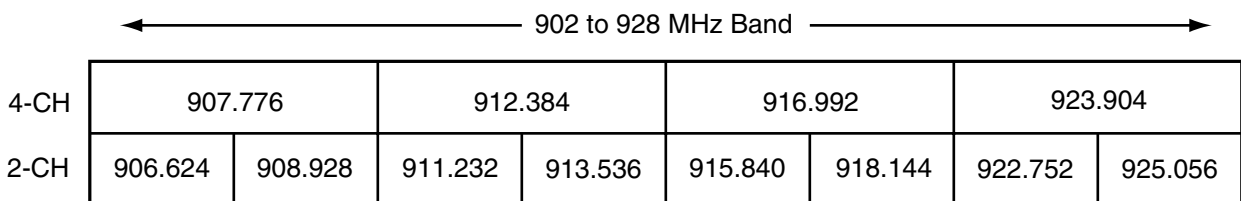

*Center frequencies of operation*

# General Technical Description

## D4T Transmitter

The transmitter can accept up to four inputs from digital or analog sources. The inputs can be configured as follows:

- Four analog inputs using all four jacks
- Two digital inputs using jack 1 and two balanced analog inputs using jacks 3 and 4
- Four digital channels using jacks 1 and 2

The input connectors are TA3 “mini XLR” types with the same pin numbering as standard XLR connectors for AES/EBU and balanced line level analog signals.

Input preamp circuits use a special balanced amplifier with very high common mode rejection to minimize hum and noise.

Either analog or AES/EBU digital input signals are converted to an internal 24-bit digital format which is then encoded, organized into packets, and passed to an RF modulator using spread spectrum techniques and error correction for robust reception. The modulated RF signal is filtered before and after amplification to suppress out-of-band noise and spurious signals, and a circulator/isolator guards against intermodulation interference (IM).

A USB port is provided for firmware updates.

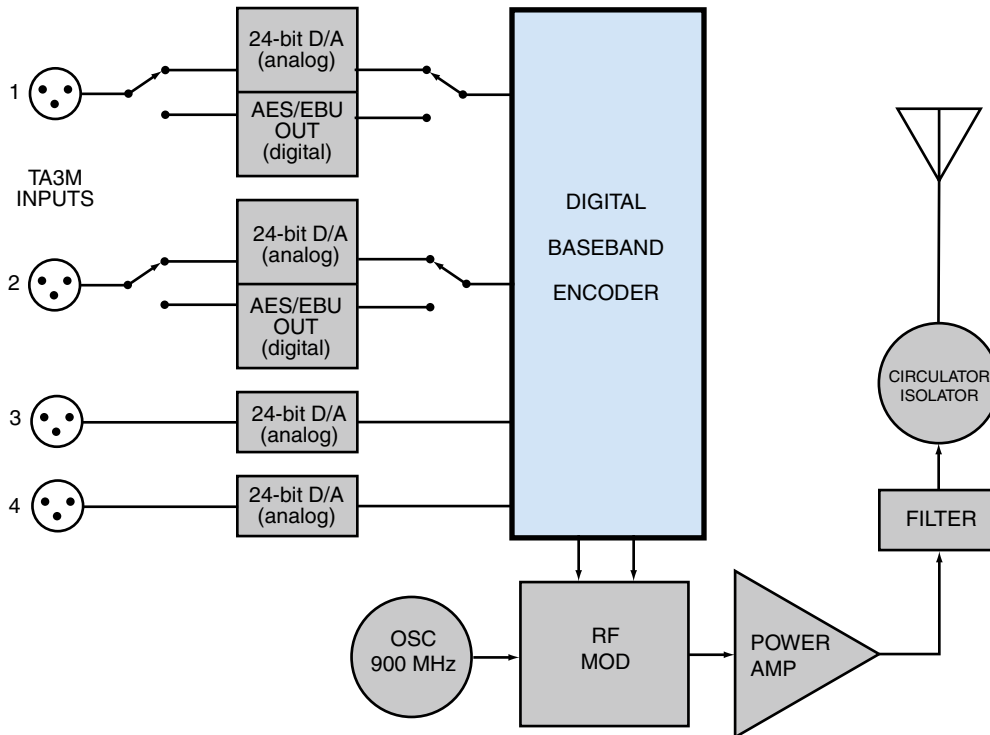

## D4R Receiver

The receiver employs two complete RF sections for true diversity reception. The signals from both antennas are independently decoded and error-corrected, and the diversity system uses all digital data and timing reference information from both antennas in order to reconstruct the original audio signals. Audio outputs may be configured for analog balanced or AES/EBU digital signals.

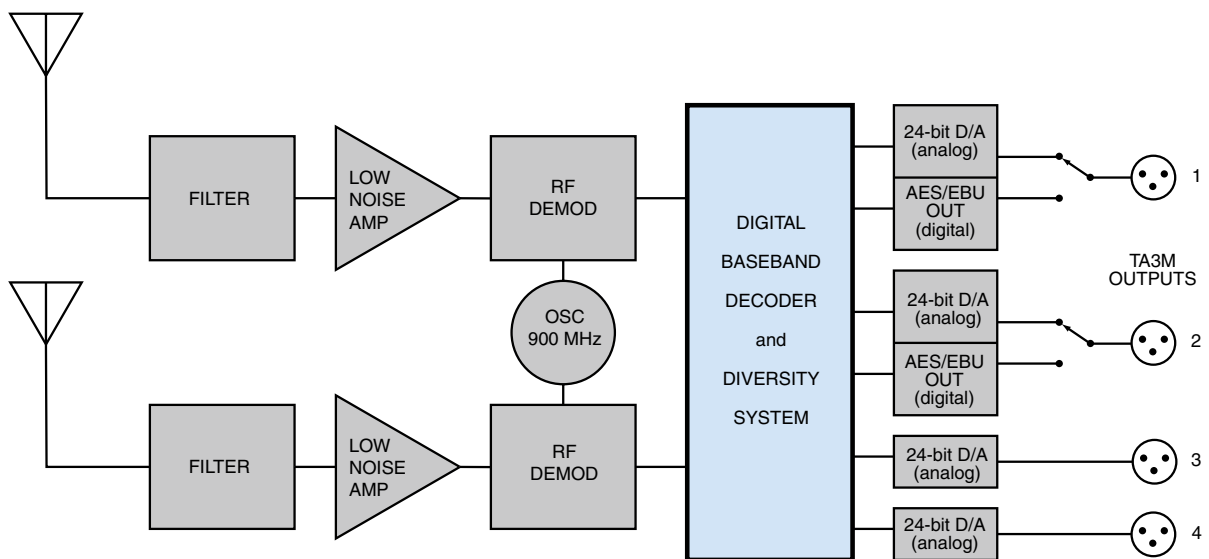

# Front and Rear Panels

On both the D4T and the D4R, the front panel interface contains a power switch, an LCD display and eight push buttons. The D4T has one antenna jack and the D4R has two. The D4R front panel also contains a jack for headphones.

When the units are powered on, an initial introductory splash screen is displayed; the Main Window then appears and remains on the LCD until a setup screen is selected. The Main Window shows four audio level meters, one for each channel. (In two channel mode, only two meters are shown.) Each audio meter bar graph will switch to display the word *CLIP* to warn of possible overload distortion at high levels. The D4R receiver Main Window also includes an RF level meter, headphone volume control and channel indicator.

Button functions are context-sensitive, but as shown in the illustrations, the FUNC and BACK buttons may be used to enter and leave various menus and setup screens. No other buttons are active in the D4T's Main Window – they are only used for setting up the D4T.

In the D4R's Main Window, the UP and DOWN arrow keys adjust the headphone volume. A fader icon next to the buttons shows the current position of the control.

The channel select buttons choose a channel for headphone monitoring. Any two buttons may be pressed simultaneously to monitor a stereo pair. Headphone icons above the buttons indicate the current headphone monitoring selection.

On the rear panel are the four audio jacks, the power receptacle and the USB port (for firmware updates). Jacks 1 and 2 may be used for either analog or AES/EBU digital signals. Jacks 3 and 4 are for analog signals only. Please see AES3 Modes on page 12 for more information on various configurations.

The units are powered with an external source of 9 to 16 VDC, with power consumption of 500 mA at 10 volts for the transmitter and 250 mA at 10 volts for the receiver.

## D4T Transmitter

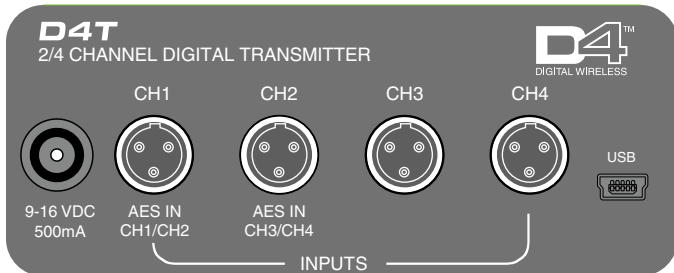
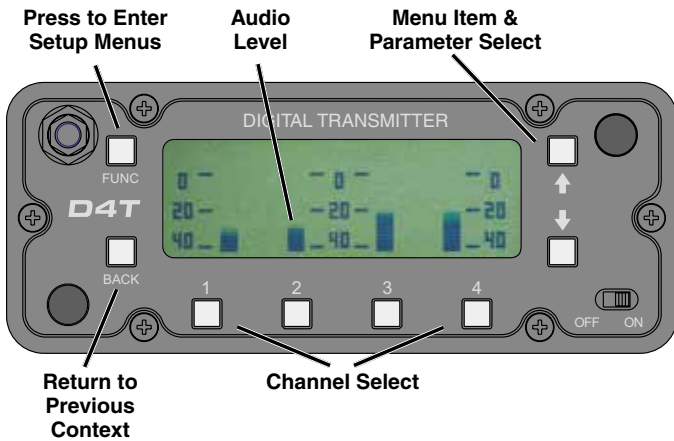

The Main Window will indicate possible clipping on the bar graph.



## D4R Receiver

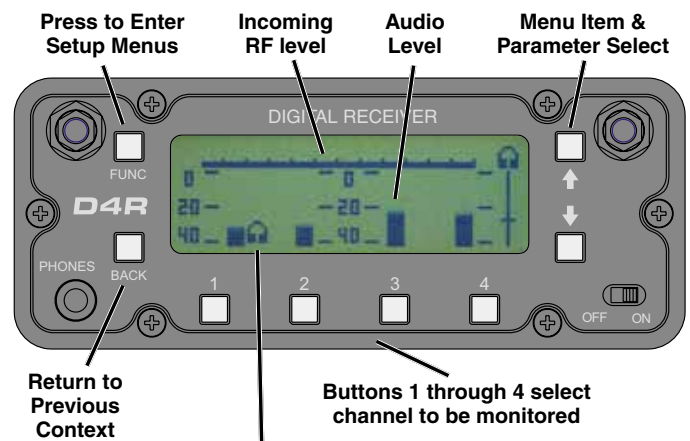

Channel selected for headphone monitoring – individual or paired for stereo monitoring



## Navigating the LCD

Navigation through setup screens is the same on the transmitter and receiver. The Main Window will display audio levels for all active channels while the system is operating.

Press the FUNC button to enter the setup menu.

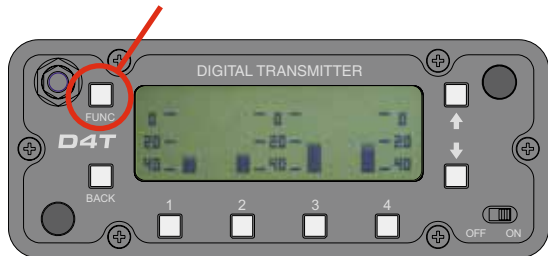

Then press the UP and DOWN arrow buttons to select a menu item.

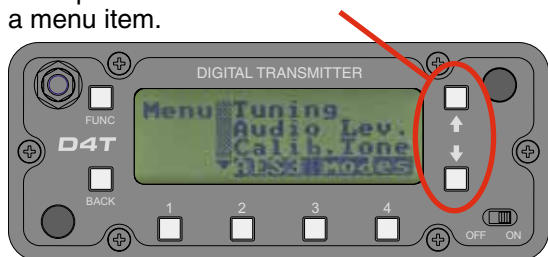

Press the FUNC button to enter the setup screen for the selected item. Then use the UP and DOWN arrow buttons to select a value or mode.

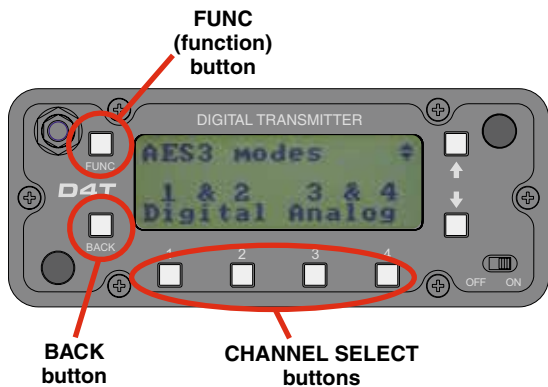

Press BACK once to return to the Menu or twice to return to the Main Window.

**Note:** In setup screens where individual channel selections are made, press the CHANNEL SELECT button under the desired channel, then use the UP and DOWN arrows to adjust the setting or value.

## Antenna Placement and Orientation

The supplied antenna is a center fed half-wave type with a right angle elbow and rotating mount. For most applications, the whip antennas should be vertically oriented to provide a circular coverage pattern. In other orientations, the transmitter antenna should be parallel with and not directly above or below the receiver antennas.

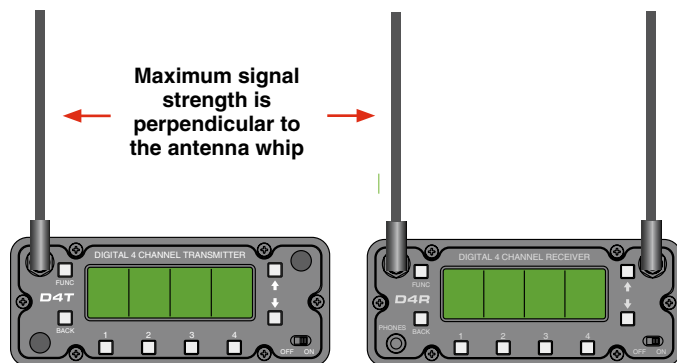

*Transmitter antenna should be parallel to receiver antennas*

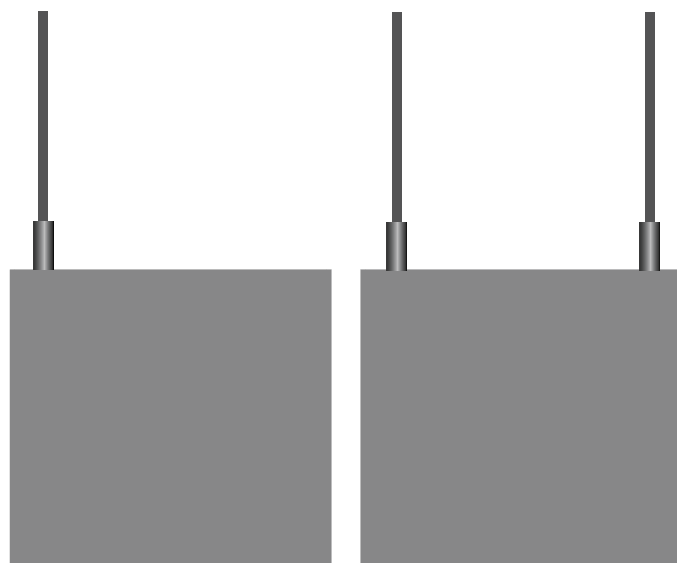

# Transmitter General Settings

## Tuning Menu



Use UP/DOWN arrows to select menu item and press FUNC to enter setup

Use UP/DOWN arrows to select frequency, then press FUNC to return to menu



## 2/4 Channel Modes



Use UP/DOWN arrows to select menu item and press FUNC to enter setup

Use UP/DOWN buttons to select desired mode



## Audio Trim



Use UP/DOWN arrows to select menu item and press FUNC to enter setup

NOTE: The setup screen will be different depending upon the AES3 Mode selection. See the next page for details.

## Locked/Unlocked Modes

The front panel controls can be locked to prevent inadvertent changes to the selected settings. When the panel is *locked*, settings can be viewed but not changed.



Use UP/DOWN arrows to select menu item and press FUNC to enter setup

Use UP/DOWN buttons to select desired mode



## AES3 Modes



Use UP/DOWN arrows to select menu item and press FUNC to enter setup

Use UP/DOWN buttons to select desired mode

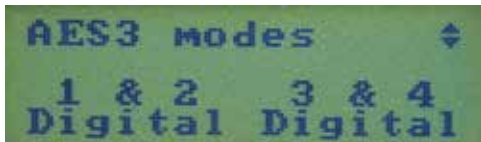
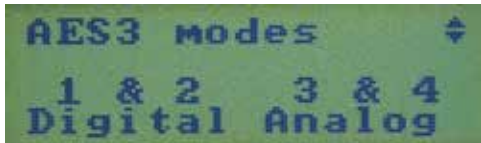



# Transmitter Audio Trim Setup

From the Main Window, press FUNC and then select the menu item "Audio Trim" and press FUNC again. The setup screen will vary slightly depending upon which AES3 mode has been selected and whether the 2-channel or 4-channel mode is selected. In the 2-channel mode, channels 3 and 4 will be blank.



Use UP/DOWN arrows to select menu item and press FUNC to enter setup

The analog inputs are designed for line level signals. There is no gain stage in the input section. Attenuation up to 20 dB can be applied to the input signal to reduce very high level signals to the optimal range.

When the audio trim control is set to +0, input clip level is +0dBu. When the audio trim control is set to -20, 20 dB of attenuation will be applied, thus moving the input clip level to +20dBu. These are the extremes, and levels in between follow the same logic.

The digital inputs can accept any standard AES/EBU signal without the need for level adjustment. Digital audio levels are accepted and transmitted without alteration.

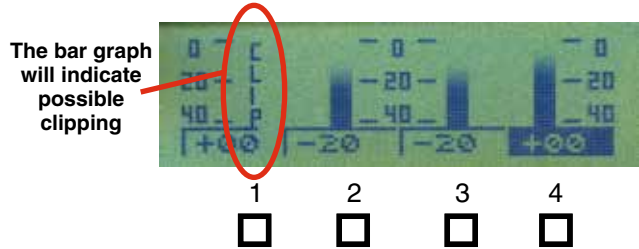

In this example, the transmitter is configured for four analog channels. Select each channel with the button below it and use the UP and DOWN arrow buttons to set the desired level.

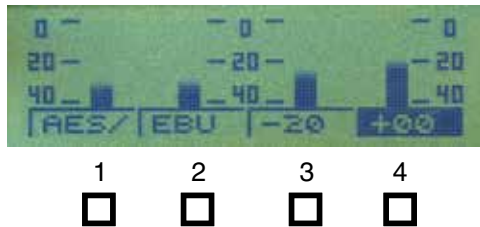

When the transmitter is configured for two digital and two analog inputs, press the button under the analog channel to be adjusted and then use the UP and DOWN buttons to set the desired level.



The audio trim adjustment only applies to analog inputs. When the transmitter is configured for four digital channels using the two AES/EBU inputs, no trim adjustment is needed.

# Receiver General Settings

## Tuning Selection



Use UP/DOWN arrows to select menu item and press FUNC to enter setup

Use UP/DOWN arrows to select frequency, then press FUNC to return to menu



## Audio Level



Use UP/DOWN arrows to select menu item and press FUNC to enter setup

NOTE: The setup screens for audio level will be different depending upon the AES3 Mode selected. See the next page for details.

## Calibration Tone

A steady tone at the maximum level before clipping can be turned on at each output to allow accurate input level adjustment of the attached mixer, recorder or other connected equipment.

While the tone level is always the maximum before clipping, the audio output level may be adjusted on any analog output. Any adjustments made to the analog output levels here are automatically applied to the audio level setup screen as well.

The *Calib. Tone* menu item accesses a setup screen which looks and operates the same way as the audio level setup screen. The difference is that a 1 kHz tone is produced at all outputs at the level shown.



Use UP/DOWN arrows to select menu item and press FUNC to enter setup



Press the button under the analog channel to be adjusted and then use the UP and DOWN buttons to set the desired level.

## AES3 Modes



Use UP/DOWN arrows to select menu item and press FUNC to enter setup

Use UP/DOWN buttons to select desired mode

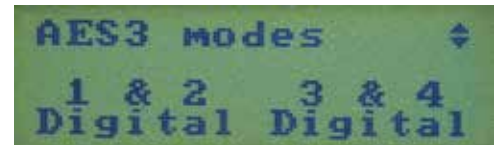
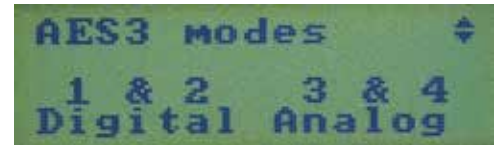
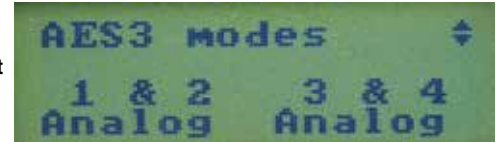

## 2/4 Channel Modes



Use UP/DOWN arrows to select menu item and press FUNC to enter setup

Use UP/DOWN buttons to select desired mode



### Locked/Unlocked Modes

The front panel controls can be locked to prevent inadvertent changes to the selected settings. When the panel is *Locked*, settings can be viewed but not changed, with the exception of headphone selection and monitoring level controls.



Use UP/DOWN arrows to select menu item and press FUNC to enter setup

Use UP/DOWN buttons to select desired mode



## Receiver Audio Level Setup

From the Main Window, press FUNC and then select the menu item *Audio Lev.* and press FUNC again. The setup screen will vary slightly depending upon which AES3 mode has been selected and whether the 2-channel or 4-channel mode is selected. In the 2-channel mode, channels 3 and 4 will be blank.



Use UP/DOWN arrows to select menu item and press FUNC to enter setup

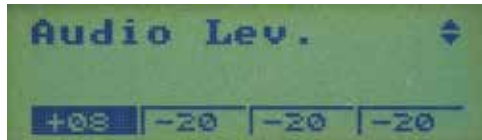

When the receiver is configured for four analog outputs, press the button under the channel to be adjusted and then use the UP and DOWN buttons to set the desired level.

NOTE: The value shown in the setup screen is the analog output level in dBu at the maximum level before clipping.

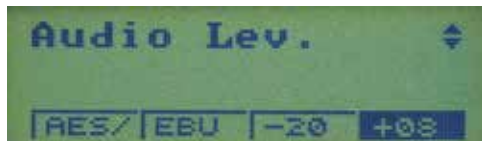

When the receiver is configured for two digital and two analog inputs, press the button under the analog channel to be adjusted and then use the UP and DOWN buttons to set the desired level.

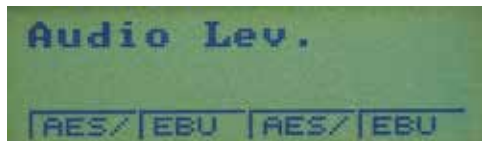

The audio level adjustment only applies to analog outputs. When the receiver is configured for four digital channels using the two AES/EBU outputs, no level adjustment is needed.

# Transmitter AES3 Modes

The transmitter can be set up in three different configurations with the AES3 modes menu for 4-channel operation:

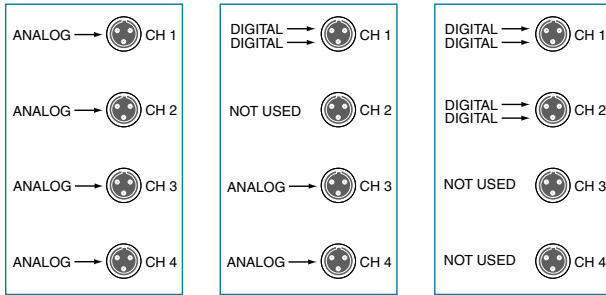

Two different configurations are available for 2-channel operation:

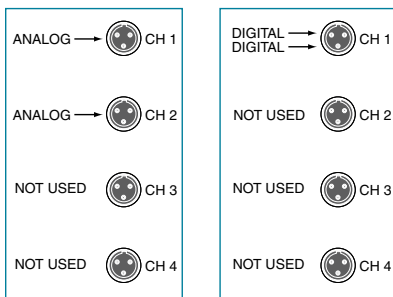

# Receiver AES3 Modes

The receiver audio outputs can be configured in the same manner as the transmitter for 4-channel operation:

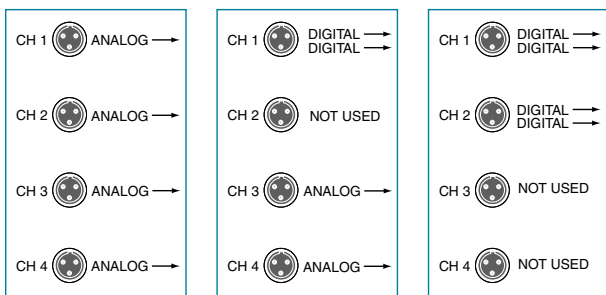

Two different configurations are available for 2-channel operation:

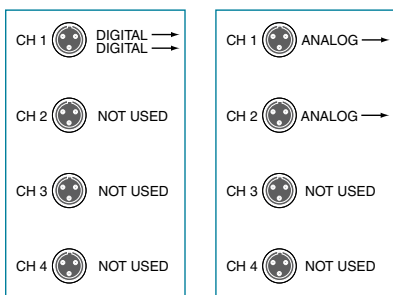

# Mixed Modes

The selected AES3 modes on the transmitter and receiver do not have to be identical. For example, analog signals can be fed into the transmitter from a mixer or wireless mic receivers, transmitted to the D4R receiver, which can be configured for four digital outputs to feed a digital recorder.

The sampling rate of the audio at the receiver digital outputs will always be 48 kHz, regardless of the sampling rate of the signal fed into the transmitter.

**NOTE:** Transmitter and receiver must be set for the same number of audio channels.

# Connector Pinouts

TA3M (3-pin male) panel mount connectors are used on the transmitter and receiver because they are smaller than the flange mounted female jacks, and to allow the use of right angle connectors such as the RATPAC. The same pin numbering as XLR jacks is used for AES-EBU and analog audio devices.

### Digital Signals – two audio channels per jack:

- Pin 1: Shield (ground)
- Pin 2: Signal
- Pin 3: Signal

### Analog Signals – one audio channel per jack:

- Pin 1: Shield (ground)
- Pin 2: Audio (+)
- Pin 3: Audio (-)

When looking at the rear panel of the transmitter and receiver, the pins in the TA3M jack are numbered in this pattern:

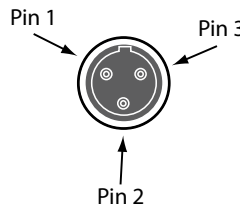

Polarity of pins 2 and 3 is not important in the digital domain, but it is generally good practice to maintain the pin to pin connections shown below when adapting to standard XLR connectors. Adapter cables wired this way can be used for both digital and analog signals.

TA3M	XLR
Pin 1	Pin 1
Pin 2	Pin 2
Pin 3	Pin 3

## Frequency Selection

Frequencies are arranged into four groupings as shown below, with each grouping containing one 4-channel frequency and two 2-channel frequencies.

In the 4-channel mode (4 audio channels) one of four different frequencies may be selected, each containing four audio channels. In the 2-channel mode (2 audio channels) one of eight frequencies may be selected, each containing two audio channels.

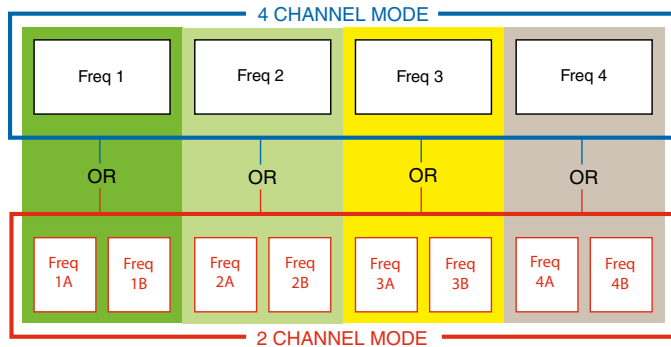

### Compatibility

In the 4-channel mode, all four frequencies can be used together in the same location. Where any 4-channel frequency is in use, neither of the 2-channel frequencies in the same grouping can be used.

In the 2-channel mode, any of the frequencies can be used together. The 4-channel frequency in the same grouping cannot be used if either one or both of its 2-channel frequencies are in use.

Up to 16 audio channels are available using multiple systems in various combinations of 2-channel and 4-channel modes.

## Finding Clear Frequencies

It is best to check for interference before selecting a frequency. Turn the receiver on and leave the transmitter off. Observe the RF level indicator in the Main Window to see if signal is present.

Weak RF level



Strong RF level



If a signal is indicated, navigate to the tuning setup screen and select a different frequency. Then return to the Main Window and check for the presence of an RF signal again. Proceed in this manner to find a frequency where no RF signal is present, or to the frequency indicating the weakest signal present.

With multiple systems operating in the same location, select a different frequency for each system. (See Frequency Selection on the previous page for details.)

Walk test each system through the area where it will be operating and listen for dropouts while observing the RF level indicator on the receiver LCD. It is best to have all equipment in the location turned on and connected to check for interference that might be generated by other devices.

If the RF level on the receiver LCD indicates a weak overall level, try re-positioning the antennas. Re-orienting the antennas or moving them even a few inches away from nearby surfaces can also make a difference.

If dropouts are experienced during the walk test, but the RF level at the receiver remains strong, there could be interference on that frequency band. Switch the system to another frequency and walk test the system again to check for adequate operating range.

# Parts and Accessories

## Transmitter Power Supplies

- Lectrosonics DCR12/A8U  
(Replacement Power Supply)  
Power Supply for D4T & D4R; 100-240 VAC, 50/60 Hz input; 12 VDC (regulated), 800 mA max. output.



- Lectrosonics DCR15/1A6U  
Switching power supply with a universal socket (IEC 60320 C13) on housing and locking plug; 90-240 VAC, 50/60 Hz input; 15 VDC, 1.6 A max. output (regulated), 18 W. (Includes 21499 AC power cord)



## Receiver Power Supplies

- Lectrosonics DCR12/A8U  
(Replacement Power Supply)  
Power Supply for D4T & D4R; 100-240 VAC, 50/60 Hz input; 12 VDC (regulated), 800 mA max. output.



- Lectrosonics CH20  
Transformer power supply with a 2-pin AC input plug and a locking power output plug; 115 VAC input, 12V DC regulated output; 500 mA max.



**Not for use with  
D4T transmitter**

- Lectrosonics DCR15/1A6U  
Switching power supply with a universal socket (IEC 60320 C13) on housing,; 90-240 VAC, 50/60 Hz input; 15 VDC, 1.6 A max. output (regulated), 18 W. (Includes 21499 AC power cord)



## AC Power Cord

- Lectrosonics 21499 Power Cord. 3-pin NEMA 5-15 plug (USA); for use with DCR15/1A6U



### Power Adapter Cables

- 21747 right angle, locking plug with 6 ft. cable to stripped and tinned leads. Supplied with the transmitter and receiver.



Supplied with the transmitter and receiver

- 21746 right angle, locking plug with 12 inch cable to stripped and tinned leads.



- 21586 straight, locking plug with 6 ft. cable to stripped and tinned leads.



- 21425 straight, non-locking plug with 6 ft. cable to stripped and tinned leads.



- 21472 right angle, non-locking plug with 6 ft. cable to stripped and tinned leads.



### Antenna

- AMJR-915 adjustable antenna for D4R and D4T. Supplied with transmitter and receiver (reverse gender SMA connector).



### Audio Cables

- MCSRXLR receiver output cable; TA3F to male XLR 3-pin; 12 in. length



- MCSRXLRF transmitter input cable; TA3F to female XLR 3-pin; 12 in. length



- 21798 USB cable for firmware updates; USB 2.0 to Mini-b; 2 meter length



## Firmware Updates

As new versions of the firmware become available, updates are accomplished with a software utility and simple procedure. In many cases, updates must be made to both transmitter and receiver to ensure compatibility and provide the latest feature set.

The software interface operates with Windows 2000, XP and Vista operating systems.

### Configuring the USB Port

- 1) Remove any previous LecNet2 installation from your computer.
- 2) Install LecNet2 software. Use the CD supplied with the D4 system or download the LecNet2 Software Installer or the CD contents from the web site:  
*<http://www.lectrosonics.com/lecnet2/lecnet2.htm>*
- 3) On the same web page, scroll down to *LecNet2 Firmware Updates*. Download the latest D4R and D4T firmware files and store them in a convenient directory on your local hard drive. The files are stored on the web site as .zip files. After they are extracted the filename extension is .rpd.
- 4) Connect power to the D4 unit.
- 5) Plug the USB cable into the D4 unit. If this is the first time this unit has been connected to this computer, Windows will ask for a driver location. The default directory used by the LecNet2 installer is:

*c:\Program Files\Lectrosonics\drivers*

Once the driver is located, Windows will complete the installation and display a message stating that the USB device is now ready to be used.

**NOTE:** If a message appears during installation stating that the driver is not signed by Microsoft, click on *Continue* to finish the installation.

### Installing Firmware

Make certain that the USB port is configured to communicate with the D4 unit. If not, follow the procedure outlined above to install the USB driver.

Launch the D4 utility:

*Start>All Programs>LecNet2>Tools>D4 Update Utility*



The *Browse* button is used to select the file to be loaded into the D4 unit.

The *Write* button initiates the installation process.

The *Verify* button on the D4 Utility program control panel is used to compare the version of the selected file with that of the firmware installed in the D4 unit. Clicking the button will start the process. After a few seconds, an *OK* screen will appear if the versions are the same, or a *mismatch* screen will appear if the versions are different.

**NOTE:** Verification takes place automatically during the installation process launched by clicking the *Write* button.

The firmware version in the D4 unit is displayed briefly on the LCD during the turn-on cycle. The version of the downloaded firmware file is indicated by its filename.

- 1) Click on the *Browse* button and select the folder where the downloaded firmware files are stored. Select the correct file for either the receiver or transmitter, whichever is connected.
- 2) Click the *Write* button to copy the new firmware into the D4 unit. The progress bar will indicate as the firmware is being updated.
- 3) After about 30 seconds an *OK* message will appear if the installation was successful.
- 4) Click the *Exit* button to close the software panel.

If the wrong firmware is installed into a D4 unit (such as the D4R receiver firmware being loaded into the D4T transmitter) the installation process will appear to work but the LCD on the D4 unit will likely be blank and the unit will not operate. Installing the correct firmware will restore the unit to normal operation.

### Compatibility with Quadra

Firmware v3.0 and higher enables compatibility with the Quadra wireless IEM system, with lower latency than earlier firmware versions. The D4T and D4R must both be updated to v3.0 for compatibility with the Quadra system.

M4T and M4R firmware v.3.0 is not compatible with earlier firmware versions.



# Specifications

## Overall System

Operating Spectrum:	902 - 928 MHz
Center Frequencies (MHz): 4-channel Mode:	907.776, 912.384, 916.992, 923.904 Four 4-channel systems can operate simultaneously for a total of 16 audio channels.
Center Frequencies (MHz): 2-channel Mode:	906.624, 908.928, 911.232, 913.536, 915.840, 918.144, 922.752, 925.056 Eight 2-channel systems can operate simultaneously for a total of 16 audio channels
Modulation Type:	Differential QPSK with Forward Error Correction, spread spectrum
Occupied Bandwidth:	4 MHz (4-channel mode), 2 MHz (2-channel mode)
Audio Sampling:	48 kHz, 24-bit
Latency (overall system): Digital In/Digital Out: Analog In/Analog Out:	Less than 0.5 mS 1.0 mS
Selectable Audio Channels:	<ul style="list-style-type: none"> <li>• 4 digital</li> <li>• 2 digital, 2 analog</li> <li>• 4 analog</li> </ul>
Audio Performance (overall system): Frequency Response: THD+N: Dynamic Range: Adjacent Channel Isolation:	20 Hz - 20 kHz, +/- 0.5 dB < 0.05% (1 kHz @ -10 dBFS) > 104 dB A-weighted > 93 dB

## D4T Transmitter

Power output:	200 mW
Audio Input:	Simulated transformer balanced inputs, clip level adjustable +0 to +20 dBu (or AES/EBU digital standard)
Power requirements:	9 - 16 VDC
Power consumption:	<ul style="list-style-type: none"> <li>• 675 mA at 9 VDC</li> <li>• 495 mA at 12 VDC</li> <li>• 390 mA at 15 VDC</li> </ul>
Dimensions:	4 x 4 x 1.5 inches
Weight:	339 grams; 12 ounces

## D4R Receiver

Diversity Type:	Dual receivers with artifact-free digital combining
Audio Output:	Electronically balanced outputs, max. level adjustable -20 to +8 dBu (or AES/EBU digital standard)
Power requirements:	9 - 16 VDC
Power consumption:	<ul style="list-style-type: none"> <li>• 306 mA at 9 VDC</li> <li>• 233 mA at 12 VDC</li> <li>• 195 mA at 15 VDC</li> </ul>
Dimensions:	4 x 4 x 1.5 inches
Weight:	346 grams; 12.2 ozs.

## FCC Notice

NOTE: This equipment has been tested and found to comply with the limits for a Class B digital device, pursuant to Part 15 of the FCC Rules. These limits are designed to provide reasonable protection against harmful interference in a residential installation. The equipment generates, uses and can radiate radio frequency energy and, if not installed and used in accordance with the instructions, may cause harmful interference to radio communications. However, there is no guarantee that interference will not occur in a particular installation. If this equipment does cause harmful interference to radio or television reception, which can be determined by turning the equipment off and on, the user is encouraged to try to correct the interference by one or more of the following measures:

- Reorient or relocate the receiving antenna
- Increase the separation between the equipment and receiver
- Connect the equipment into an outlet on a circuit different from that which the receiver is connected
- Consult the dealer or an experienced radio/TV technician for help

Changes or modifications to this equipment not expressly approved by Lectrosonics, Inc. could void the user's authority to operate it.

## Industry Canada Notices:

Operation of this device is subject to the following two conditions: (1) this device may not cause interference, and (2) this device must accept interference, including interference that may cause undesired operation of the device.

This device has been designed to operate with the antenna listed below, and having a maximum gain of 6 dB. Antennas not included in this list or having a gain greater than 6 dB are strictly prohibited for use with this device. The required antenna impedance is 50 ohms.

*Lectrosonics P/N: AMJR-915*

To reduce potential radio interference to other users, the antenna type and its gain should be so chosen that the equivalent isotropically radiated power (e.i.r.p.) is not more than that permitted for successful communication.

## Service and Repair

If your system malfunctions, you should attempt to correct or isolate the trouble before concluding that the equipment needs repair. Make sure you have followed the setup procedure and operating instructions. Check the inter-connecting cables and then go through the **Troubleshooting** section in this manual.

We strongly recommend that you **do not** try to repair the equipment yourself and **do not** have the local repair shop attempt anything other than the simplest repair. If the repair is more complicated than a broken wire or loose connection, send the unit to the factory for repair and service. Don't attempt to adjust any controls inside the units. Once set at the factory, the various controls and trimmers do not drift with age or vibration and never require readjustment. **There are no adjustments inside that will make a malfunctioning unit start working.**

Lectrosonics' Service Department is equipped and staffed to quickly repair your equipment. In-warranty repairs are made at no charge in accordance with the terms of the warranty. Out-of-warranty repairs are charged at a modest flat rate plus parts and shipping. Since it takes almost as much time and effort to determine what is wrong as it does to make the repair, there is a charge for an exact quotation. We will be happy to quote approximate charges by phone for out-of-warranty repairs.

## Returning Units for Repair

For timely service, please follow the steps below:

- A.** DO NOT return equipment to the factory for repair without first contacting us by email or by phone. We need to know the nature of the problem, the model number and the serial number of the equipment. We also need a phone number where you can be reached 8 A.M. to 4 P.M. (U.S. Mountain Standard Time).
- B.** After receiving your request, we will issue you a return authorization number (R.A.). This number will help speed your repair through our receiving and repair departments. The return authorization number must be clearly shown on the **outside** of the shipping container.
- C.** Pack the equipment carefully and ship to us, shipping costs prepaid. If necessary, we can provide you with the proper packing materials. UPS is usually the best way to ship the units. Heavy units should be "double-boxed" for safe transport.
- D.** We also strongly recommend that you insure the equipment, since we cannot be responsible for loss of or damage to equipment that you ship. Of course, we insure the equipment when we ship it back to you.

### Lectrosonics USA:

**Mailing address:**

Lectrosonics, Inc.  
PO Box 15900  
Rio Rancho, NM 87174  
USA

**Shipping address:**

Lectrosonics, Inc.  
581 Laser Rd.  
Rio Rancho, NM 87124  
USA

**Telephone:**

(505) 892-4501  
(800) 821-1121 Toll-free  
(505) 892-6243 Fax

**Web:**

[www.lectrosonics.com](http://www.lectrosonics.com)

**E-mail:**

[sales@lectrosonics.com](mailto:sales@lectrosonics.com)

### Lectrosonics Canada:

**Mailing Address:**

720 Spadina Avenue,  
Suite 600  
Toronto, Ontario M5S 2T9

**Telephone:**

(416) 596-2202  
(877) 753-2876 Toll-free  
(877-7LECTRO)  
(416) 596-6648 Fax

**E-mail:**

Sales: [colinb@lectrosonics.com](mailto:colinb@lectrosonics.com)  
Service: [joeb@lectrosonics.com](mailto:joeb@lectrosonics.com)



## LIMITED ONE YEAR WARRANTY

The equipment is warranted for one year from date of purchase against defects in materials or workmanship provided it was purchased from an authorized dealer. This warranty does not cover equipment which has been abused or damaged by careless handling or shipping. This warranty does not apply to used or demonstrator equipment.

Should any defect develop, Lectrosonics, Inc. will, at our option, repair or replace any defective parts without charge for either parts or labor. If Lectrosonics, Inc. cannot correct the defect in your equipment, it will be replaced at no charge with a similar new item. Lectrosonics, Inc. will pay for the cost of returning your equipment to you.

This warranty applies only to items returned to Lectrosonics, Inc. or an authorized dealer, shipping costs prepaid, within one year from the date of purchase.

This Limited Warranty is governed by the laws of the State of New Mexico. It states the entire liability of Lectrosonics Inc. and the entire remedy of the purchaser for any breach of warranty as outlined above. **NEITHER LECTROSONICS, INC. NOR ANYONE INVOLVED IN THE PRODUCTION OR DELIVERY OF THE EQUIPMENT SHALL BE LIABLE FOR ANY INDIRECT, SPECIAL, PUNITIVE, CONSEQUENTIAL, OR INCIDENTAL DAMAGES ARISING OUT OF THE USE OR INABILITY TO USE THIS EQUIPMENT EVEN IF LECTROSONICS, INC. HAS BEEN ADVISED OF THE POSSIBILITY OF SUCH DAMAGES. IN NO EVENT SHALL THE LIABILITY OF LECTROSONICS, INC. EXCEED THE PURCHASE PRICE OF ANY DEFECTIVE EQUIPMENT.**

This warranty gives you specific legal rights. You may have additional legal rights which vary from state to state.

