

Operating Instructions Functional Manual

DLP™ Projector Commercial Use

Model No. **PT-RZ570**

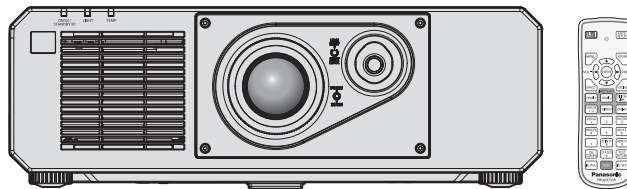

Thank you for purchasing this Panasonic product.

- This manual is common to all the models regardless of suffixes of the Model No.
 - for Taiwan
 - BT: Black model WT: White model
 - for India
 - BD: Black model WD: White model
 - for Asia (except for Taiwan, India, Korea) / Oceania / Africa
 - BA: Black model WA: White model
 - B: Black model W: White model
 - for other countries or regions
 - B: Black model W: White model
- Before operating this product, please read the instructions carefully and save this manual for future use.
- Before using this product, be sure to read “Read this first!” (➡ pages 5 to 13).



Contents

Read this first!	5	Operating with the remote control	50
		Using the shutter function.....	50
		Using the mute function.....	50
		Adjusting the volume.....	51
		Using the freeze function.....	51
		Using the on-screen display function.....	51
		Using the automatic setup function.....	52
		Using the screen adjustment function.....	52
		Switching the image aspect ratio.....	53
		Using the P IN P function.....	53
		Using the function button.....	53
		Displaying internal test pattern.....	53
		Using the status function.....	54
		Using the ECO management function.....	54
		Setting ID number of the remote control.....	54
Chapter 1 Preparation		Chapter 4 Settings	
Precautions for use	17	Menu navigation	57
Lens protection material.....	17	Navigating through the menu.....	57
Cautions when transporting.....	17	Main menu.....	58
Cautions when installing.....	17	Sub-menu.....	59
Security.....	19	[PICTURE] menu	62
DIGITAL LINK.....	20	[PICTURE MODE].....	62
Art-Net.....	20	[CONTRAST].....	62
Early Warning Software.....	20	[BRIGHTNESS].....	62
Disposal.....	20	[COLOR].....	63
Cautions on use.....	20	[TINT].....	63
Accessories.....	22	[COLOR TEMPERATURE].....	63
Optional accessories.....	23	[WHITE GAIN].....	64
About your projector	24	[GAMMA].....	65
Remote control.....	24	[DAYLIGHT VIEW].....	65
Projector body.....	26	[SHARPNESS].....	65
Preparing the remote control	28	[NOISE REDUCTION].....	66
Inserting and removing the batteries.....	28	[DYNAMIC CONTRAST].....	66
When using the multiple projectors.....	28	[SYSTEM SELECTOR].....	66
		sRGB-compliant video.....	67
Chapter 2 Getting Started		[POSITION] menu	68
Setting up	30	[SHIFT].....	68
Installation mode.....	30	[ASPECT].....	68
Parts for installation (optional).....	31	[ZOOM].....	69
Projected image and throw distance.....	31	[CLOCK PHASE].....	70
Adjusting adjustable feet.....	33	[SCREEN ADJUSTMENT].....	70
Connecting	34		
Before connecting.....	34		
Connecting example: AV equipment.....	35		
Connecting example: Computers.....	36		
Connecting example using DIGITAL LINK.....	37		
Chapter 3 Basic Operations			
Switching on/off the projector	40		
Connecting the power cord.....	40		
Power indicator.....	40		
Switching on the projector.....	41		
When the initial setting screen is displayed.....	42		
Making adjustments and selections.....	45		
Switching off the projector.....	46		
Projecting	47		
Selecting the input signal.....	47		
Adjusting the image.....	48		
Adjustment range by the lens position shift (optical shift).....	49		

Contents

[ADVANCED MENU] menu	73	[SIGNAL LIST] menu	115
[DIGITAL CINEMA REALITY].....	73	Registering new signals.....	115
[BLANKING].....	73	Renaming the registered signal.....	115
[INPUT RESOLUTION].....	74	Deleting the registered signal.....	115
[CLAMP POSITION].....	74	Protecting the registered signal.....	116
[EDGE BLENDING].....	74	Expanding signal lock-in range.....	116
[FRAME RESPONSE].....	76	Sub memory.....	117
[RASTER POSITION].....	77	[SECURITY] menu	118
[DISPLAY LANGUAGE] menu	78	[SECURITY PASSWORD].....	118
Changing the display language.....	78	[SECURITY PASSWORD CHANGE].....	118
[DISPLAY OPTION] menu	79	[DISPLAY SETTING].....	118
[COLOR MATCHING].....	79	[TEXT CHANGE].....	119
[COLOR CORRECTION].....	80	[CONTROL DEVICE SETUP].....	119
[SCREEN SETTING].....	80	[CONTROL DEVICE PASSWORD CHANGE]	
[AUTO SIGNAL].....	81	120
[AUTO SETUP].....	81	[NETWORK] menu	122
[COMPUTER IN/OUT].....	82	[DIGITAL LINK MODE].....	122
[DVI-D IN].....	84	[DIGITAL LINK STATUS].....	122
[HDMI IN].....	85	[NETWORK SETUP].....	123
[DIGITAL LINK IN].....	86	[NETWORK CONTROL].....	123
[ON-SCREEN DISPLAY].....	87	[NETWORK STATUS].....	124
[CLOSED CAPTION SETTING] (for NTSC or		[DIGITAL LINK MENU].....	124
480i YC _B C _R signal input only).....	89	[Art-Net SETUP].....	124
[BACK COLOR].....	90	[Art-Net CHANNEL SETTING].....	125
[STARTUP LOGO].....	90	[Art-Net STATUS].....	125
[UNIFORMITY].....	91		
[SHUTTER SETTING].....	92	Chapter 5 Operations	
[FREEZE].....	93	Network connection	127
[WAVEFORM MONITOR].....	93	Connecting to the network.....	127
[CUT OFF].....	94	Web control function	130
[PROJECTOR SETUP] menu	95	Computer that can be used for setting.....	130
[PROJECTOR ID].....	95	Accessing from the web browser.....	130
[PROJECTION METHOD].....	95		
[ECO MANAGEMENT].....	96	Chapter 6 Maintenance	
[BRIGHTNESS CONTROL].....	99	Light source/temperature indicators	148
[SCHEDULE].....	103	When an indicator lights up.....	148
[INITIAL STARTUP].....	105	Maintenance	150
[STARTUP INPUT SELECT].....	105	Before maintaining the projector.....	150
[RS-232C].....	106	Maintenance.....	150
[FUNCTION BUTTON].....	106	Troubleshooting	151
[AUDIO SETTING].....	107	[SELF TEST] indications	153
[STATUS].....	108		
[DATE AND TIME].....	109	Chapter 7 Appendix	
[SAVE ALL USER DATA].....	110	Technical information	156
[LOAD ALL USER DATA].....	110	PJLink protocol.....	156
[INITIALIZE].....	111	Using Art-Net function.....	157
[SERVICE PASSWORD].....	111	Control commands via LAN.....	160
[P IN P] menu	112	<SERIAL IN> terminal.....	163
Using P IN P function.....	112	Two-window display combination list.....	166
[TEST PATTERN] menu	114	Control device password.....	166
[TEST PATTERN].....	114	List of compatible signals.....	167

Contents

Specifications	170
Dimensions	173
Precautions for attaching the Ceiling Mount Bracket	174
Index	175

Read this first!

WARNING: THIS APPARATUS MUST BE EARTHED.

WARNING: To prevent damage which may result in fire or shock hazard, do not expose this appliance to rain or moisture.
This device is not intended for use in the direct field of view at visual display workplaces. To avoid incommoding reflexions at visual display workplaces this device must not be placed in the direct field of view.
The equipment is not intended for used at a video workstation in compliance BildscharbV.

The sound pressure level at the operator position is equal or less than 70 dB (A) according to ISO 7779.

WARNING:

1. Remove the plug from the mains socket when this unit is not in use for a prolonged period of time.
2. To prevent electric shock, do not remove cover. No user serviceable parts inside. Refer servicing to qualified service personnel.
3. Do not remove the earthing pin on the mains plug. This apparatus is equipped with a three prong earthing-type mains plug. This plug will only fit an earthing-type mains socket. This is a safety feature. If you are unable to insert the plug into the mains socket, contact an electrician. Do not defeat the purpose of the earthing plug.

WARNING:

This equipment is compliant with Class A of CISPR32.
In a residential environment this equipment may cause radio interference.

CAUTION:

To assure continued compliance, follow the attached installation instructions. This includes using the provided power cord and shielded interface cables when connecting to computer or peripheral devices. Also, any unauthorized changes or modifications to this equipment could void the user's authority to operate this device.

This is a device to project images onto a screen, etc., and is not intended for use as indoor lighting in a domestic environment.

Directive 2009/125/EC

WARNING: TO REDUCE THE RISK OF FIRE OR ELECTRIC SHOCK, DO NOT EXPOSE THIS PRODUCT TO RAIN OR MOISTURE.

WARNING: RISK OF ELECTRIC SHOCK. DON'T OPEN



Indicated on the projector

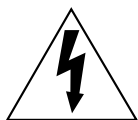

The lightning flash with arrowhead symbol, within an equilateral triangle, is intended to alert the user to the presence of uninsulated "dangerous voltage" within the product's enclosure that may be of sufficient magnitude to constitute a risk of electric shock to persons.



The exclamation point within an equilateral triangle is intended to alert the user to the presence of important operating and maintenance (servicing) instructions in the literature accompanying the product.

**Notice on laser
(for USA and Canada)**

This projector is the Class 3R laser product that complies with IEC 60825-1:2007.

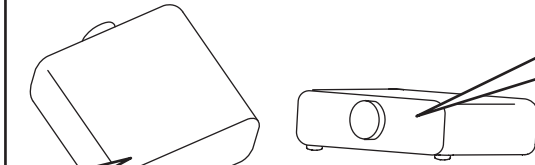

RISK GROUP 3

WARNING: POSSIBLY HAZARDOUS OPTICAL RADIATION EMITTED FROM THIS PRODUCT.
AVERTISSEMENT: DES RADIATIONS OPTIQUES NUISIBLES PEUVENT ÊTRE EMISES PAR CE PRODUIT.
WARNUNG: DIESES PRODUKT EMITTIERT MÖGLICHERWEISE GEFÄHRLICHE OPTISCHE STRAHLUNG.
ПРЕДУПРЕЖДЕНИЕ: ДАННАЯ ПРОДУКЦИЯ МОЖЕТ СОЗДАВАТЬ ОПАСНОЕ ОПТИЧЕСКОЕ ИЗЛУЧЕНИЕ.
경고: 본 제품에서 유해한 광방사가 방출되었을 가능성이 있습니다.
 TQFX340

危険-開放時クラス4のレーザー放射 TQFX502AA
 直接放射又は分散放射に眼又は皮膚を暴露させないこと
 DANGER-CLASS 4 LASER RADIATION WHEN OPEN AVOID EYE OR SKIN EXPOSURE TO DIRECT OR SCATTERED RADIATION
 DANGER-RAYONNEMENT LASER DE CLASSE 4- EN CAS D'OUVERTURE EXPOSITION DANGEREUSE AU RAYONNEMENT DIRECT OU DIFFUS DES YEUX OU DE LA PEAU

(Inside of product)

(for India)

This projector is the Class 1 laser product that complies with IEC/EN 60825-1:2014.

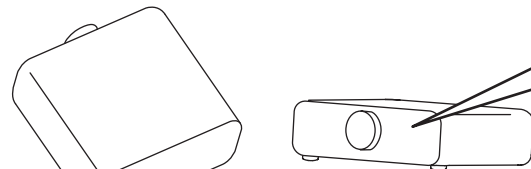

CLASS 1 LASER PRODUCT

RISK GROUP 3

WARNING: POSSIBLY HAZARDOUS OPTICAL RADIATION EMITTED FROM THIS PRODUCT.
AVERTISSEMENT: DES RADIATIONS OPTIQUES NUISIBLES PEUVENT ÊTRE EMISES PAR CE PRODUIT.
WARNUNG: DIESES PRODUKT EMITTIERT MÖGLICHERWEISE GEFÄHRLICHE OPTISCHE STRAHLUNG.
ПРЕДУПРЕЖДЕНИЕ: ДАННАЯ ПРОДУКЦИЯ МОЖЕТ СОЗДАВАТЬ ОПАСНОЕ ОПТИЧЕСКОЕ ИЗЛУЧЕНИЕ.
경고: 본 제품에서 유해한 광방사가 방출되었을 가능성이 있습니다.
 TQFX340

(for other countries or regions)

This projector is the Class 1 laser product that complies with IEC/EN 60825-1:2014.

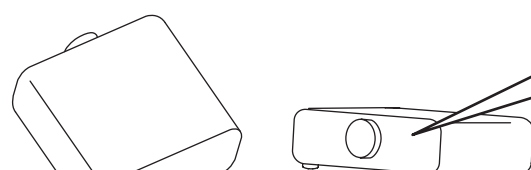

IEC/EN 60825-1:2014
 CLASS 1 LASER PRODUCT

RISK GROUP 3

WARNING: POSSIBLY HAZARDOUS OPTICAL RADIATION EMITTED FROM THIS PRODUCT.
AVERTISSEMENT: DES RADIATIONS OPTIQUES NUISIBLES PEUVENT ÊTRE EMISES PAR CE PRODUIT.
WARNUNG: DIESES PRODUKT EMITTIERT MÖGLICHERWEISE GEFÄHRLICHE OPTISCHE STRAHLUNG.
ПРЕДУПРЕЖДЕНИЕ: ДАННАЯ ПРОДУКЦИЯ МОЖЕТ СОЗДАВАТЬ ОПАСНОЕ ОПТИЧЕСКОЕ ИЗЛУЧЕНИЕ.
경고: 본 제품에서 유해한 광방사가 방출되었을 가능성이 있습니다.
 TQFX340

CAUTION (North/Middle/South America/Taiwan)

Power Supply: This Projector is designed to operate on 100 V - 240 V, 50 Hz/60 Hz AC, house current only.

CAUTION: The AC power cord which is supplied with the projector as an accessory can only be used for power supplies up to 125 V. If you need to use higher voltages than this, you will need to obtain a separate 250 V power cord. If you use the accessory cord in such situations, fire may result.

CAUTION (North/Middle/South America/Taiwan)

This equipment is equipped with a three-pin grounding-type power plug. Do not remove the grounding pin on the power plug. This plug will only fit a grounding-type power outlet. This is a safety feature. If you are unable to insert the plug into the outlet, contact an electrician. Do not defeat the purpose of the grounding plug.

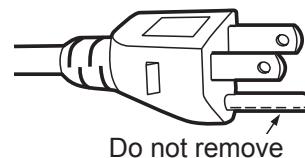

WARNING (USA and Canada)

- Not for use in a computer room as defined in the Standard for the Protection of Electronic Computer/Data Processing Equipment, ANSI/NFPA 75.
- For permanently connected equipment, a readily accessible disconnect device shall be incorporated in the building installation wiring.
- For pluggable equipment, the socket-outlet shall be installed near the equipment and shall be easily accessible.

NOTIFICATION (Canada)

This class A digital apparatus complies with Canadian ICES-003.

For USA-California Only

This product contains a CR Coin Cell Lithium Battery which contains Perchlorate Material – special handling may apply.

See www.dtsc.ca.gov/hazardouswaste/perchlorate

FCC NOTICE (USA)

Verification

Model Number: PT-RZ570B / PT-RZ570W
Trade Name: Panasonic
Responsible Party: Panasonic Corporation of North America
Address: Two Riverfront Plaza, Newark, NJ 07102-5490
General Contact: <http://www.panasonic.com/support>
Projector Contact: <http://panasonic.net/avc/projector/>

This device complies with Part 15 of the FCC Rules.

Operation is subject to the following two conditions:

(1) This device may not cause harmful interference, and (2) this device must accept any interference received, including interference that may cause undesired operation.

Caution:

This equipment has been tested and found to comply with the limits for a Class A digital device, pursuant to part 15 of the FCC Rules. These limits are designed to provide reasonable protection against harmful interference when the equipment is operated in a commercial environment. This equipment generates, uses, and can radiate radio frequency energy and, if not installed and used in accordance with the instruction manual, may cause harmful interference to radio communications. Operation of this equipment in a residential area is likely to cause harmful interference in which case the user will be required to correct the interference at his own expense.

FCC Warning:

To assure continued compliance, follow the attached installation instructions. This includes using the provided power cord and shielded interface cables when connecting to computer or peripheral devices. Also, any unauthorized changes or modifications to this equipment could void the user's authority to operate this device.

IMPORTANT: THE MOLDED PLUG

FOR YOUR SAFETY, PLEASE READ THE FOLLOWING TEXT CAREFULLY.

This appliance is supplied with a molded three pin mains plug for your safety and convenience. A 13 amp fuse is fitted in this plug. Should the fuse need to be replaced, please ensure that the replacement fuse has a rating of 13 amps and that it is approved by ASTA or BSI to BS1362.

Check for the ASTA mark  or the BSI mark  on the body of the fuse.

If the plug contains a removable fuse cover, you must ensure that it is refitted when the fuse is replaced. If you lose the fuse cover, the plug must not be used until a replacement cover is obtained. A replacement fuse cover can be purchased from an Authorized Service Center.

If the fitted molded plug is unsuitable for the mains socket in your home, then the fuse should be removed and the plug cut off and disposed of safely. There is a danger of severe electrical shock if the cut off plug is inserted into any 13 amp socket.

If a new plug is to be fitted, please observe the wiring code as shown below.
If in any doubt, please consult a qualified electrician.

WARNING: THIS APPLIANCE MUST BE EARTHED.

IMPORTANT: The wires in this mains lead are colored in accordance with the following code:

Green - and - Yellow: Earth
Blue: Neutral
Brown: Live

As the colors of the wire in the mains lead of this appliance may not correspond with the colored markings identifying the terminals in your plug, proceed as follows.

The wire which is colored GREEN - AND - YELLOW must be connected to the terminal in the plug which is marked with the letter E or by the Earth symbol  or colored GREEN or GREEN - AND - YELLOW.

The wire which is colored BLUE must be connected to the terminal in the plug which is marked with the letter N or colored BLACK.

The wire which is colored BROWN must be connected to the terminal in the plug which is marked with the letter L or colored RED.

How to replace the fuse: Open the fuse compartment with a screwdriver and replace the fuse.

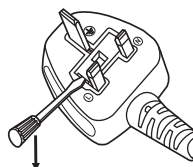

(for PT-RZ570BA / PT-RZ570WA)



Declaration of Conformity (DoC)

This equipment is in compliance with the essential requirements and other relevant provisions of Directive 1999/5/EC. Customers can download a copy of the original DoC for this product from our DoC server: <http://www.ptc.panasonic.de>
Contact in the EU: Panasonic Marketing Europe GmbH, Panasonic Testing Centre, Winsbergring 11, 22525 Hamburg, Germany

Importer's name and address within the European Union

Panasonic Marketing Europe GmbH
Panasonic Testing Centre
Winsbergring 11, 22525 Hamburg, Germany

WARNING:

■ POWER

The wall outlet or the circuit breaker shall be installed near the equipment and shall be easily accessible when problems occur. If the following problems occur, cut off the power supply immediately.

Continued use of the projector in these conditions will result in fire or electric shock.

- If foreign objects or water get inside the projector, cut off the power supply.
- If the projector is dropped or the cabinet is broken, cut off the power supply.
- If you notice smoke, strange smells or noise coming from the projector, cut off the power supply.

Please contact an Authorized Service Center for repairs, and do not attempt to repair the projector yourself.

During a thunderstorm, do not touch the projector or the cable.

Electric shocks can result.

Do not do anything that might damage the power cord or the power plug.

If the power cord is used while damaged, electric shocks, short-circuits or fire will result.

- Do not damage the power cord, make any modifications to it, place it near any hot objects, bend it excessively, twist it, pull it, place heavy objects on top of it or wrap it into a bundle.

Ask an Authorized Service Center to carry out any repairs to the power cord that might be necessary.

Do not use anything other than the provided power cord.

Failure to observe this will result in electric shocks or fire. Please note that if you do not use the provided power cord to ground the device on the side of the outlet, this may result in electric shocks.

Completely insert the power plug into the wall outlet and the power connector into the projector terminal.

If the plug is not inserted correctly, electric shocks or overheating will result.

- Do not use plugs which are damaged or wall outlets which are coming loose from the wall.

Do not handle the power plug and power connector with wet hands.

Failure to observe this will result in electric shocks.

Do not overload the wall outlet.

If the power supply is overloaded (ex., by using too many adapters), overheating may occur and fire will result.

Clean the power plug regularly to prevent it from becoming covered in dust.

Failure to observe this will cause a fire.

- If dust builds up on the power plug, the resulting humidity can damage the insulation.
- If not using the projector for an extended period of time, pull the power plug out from the wall outlet.

Pull the power plug out from the wall outlet and wipe it with a dry cloth regularly.

■ ON USE/INSTALLATION

Do not place the projector on soft materials such as carpets or sponge mats.

Doing so will cause the projector to overheat, which can cause burns, fire or damage to the projector.

Do not set up the projector in humid or dusty places or in places where the projector may come into contact with oily smoke or steam.

Using the projector under such conditions will result in fire, electric shocks or deterioration of components.

Deterioration of components (such as ceiling mount brackets) may cause the projector which is mounted on the ceiling to fall down.

Do not install this projector in a place which is not strong enough to take the full weight of the projector or on top of a surface which is sloped or unstable.

Failure to observe this will cause projector to fall down or tip over the projector, and severe injury or damage could result.

Do not cover the air intake/exhaust ports or place anything within 500 mm (19-11/16") of them.

Doing so will cause the projector to overheat, which can cause fire or damage to the projector.

- Do not place the projector in narrow, badly ventilated places.
- Do not place the projector on cloth or papers, as these materials could be drawn into the air intake port.

WARNING:

Do not look at or place your skin into the light emitted from the lens while the projector is being used.

Doing so can cause burns or loss of sight.

- Strong light is emitted from the projector's lens. Do not look at or place your hands directly into this light.
- Be especially careful not to let young children look into the lens. In addition, turn off the power and switch off the main power when you are away from the projector.

Never attempt to remodel or disassemble the projector.

High voltages can cause fire or electric shocks.

- For any inspection, adjustment and repair work, please contact an Authorized Service Center.

Doing so may cause exposure to dangerous laser radiation.

- The laser module is built in this projector. Follow procedures specified in the Operating Instructions to make operations and adjustments.

Do not allow metal objects, flammable objects, or liquids to enter inside of the projector. Do not allow the projector to get wet.

Doing so may cause short circuits or overheating, and result in fire, electric shock, or malfunction of the projector.

- Do not place containers of liquid or metal objects near the projector.
- If liquid enters inside of the projector, consult your dealer.
- Particular attention must be paid to children.

Use the ceiling mount bracket specified by Panasonic.

Using the ceiling mount bracket other than the specified one will result in falling accidents.

- Attach the supplied safety cable to the ceiling mount bracket to prevent the projector from falling down.

Installation work (such as ceiling mount bracket) should only be carried out by a qualified technician.

If installation is not carried out and secured correctly, it can cause injury or accidents, such as electric shocks.

- Be sure to use the wire provided with the ceiling mount bracket as an extra safety measure to prevent the projector from falling down. (Install in a different location to the ceiling mount bracket.)

■ ACCESSORIES

Do not use or handle the batteries improperly, and refer to the following.

Failure to observe this will cause burns, batteries to leak, overheat, explode or catch fire.

- Do not use unspecified batteries.
- Do not charge dry cell batteries.
- Do not disassemble dry cell batteries.
- Do not heat the batteries or place them into water or fire.
- Do not allow the + and – terminals of the batteries to come into contact with metallic objects such as necklaces or hairpins.
- Do not store or carry batteries together with metallic objects.
- Store the batteries in a plastic bag and keep them away from metallic objects.
- Make sure the polarities (+ and –) are correct when inserting the batteries.
- Do not use a new battery together with an old battery or mix different types of batteries.
- Do not use batteries with the outer cover peeling away or removed.

If the battery fluid leaks, do not touch it with bare hands, and take the following measures if necessary.

- Battery fluid on your skin or clothing could result in skin inflammation or injury.
Rinse with clean water and seek medical advice immediately.
- Battery fluid coming in contact with your eyes could result in loss of sight.
In this case, do not rub your eyes. Rinse with clean water and seek medical advice immediately.

Do not allow children to reach the batteries.

Accidentally swallowing them can cause physical harm.

- If swallowed, seek medical advice immediately.

Remove the depleted batteries from the remote control promptly.

- Leaving them in the unit may result in fluid leakage, overheating, or explosion of the batteries.

CAUTION:

■ POWER

When disconnecting the power cord, be sure to hold the power plug and power connector.

If the power cord itself is pulled, the lead will become damaged, and fire, short-circuits or serious electric shocks will result.

When not using the projector for an extended period of time, disconnect the power plug from the wall outlet.

Failure to do so may result in fire or electric shock.

Disconnect the power plug from the wall outlet before carrying out any cleaning.

Failure to do so may result in electric shock.

■ ON USE/INSTALLATION

Do not place heavy objects on top of the projector.

Failure to observe this will cause the projector to become unbalanced and fall, which could result in damage or injury. The projector will be damaged or deformed.

Do not put your weight on this projector.

You could fall or the projector could break, and injury will result.

- Be especially careful not to let young children stand or sit on the projector.

Do not place the projector in extremely hot locations.

Doing so will cause the outer casing or internal components to deteriorate, or result in fire.

- Take particular care in locations exposed to direct sunlight or near heaters.

Do not install the projector in a location where salt pollution or corrosive gas may occur.

Doing so may result in falling due to corrosion. Also, it may result in malfunctions.

Do not stand in front of the lens while the projector is being used.

Doing so can cause damage and burns to clothing.

- Strong light is emitted from the projector's lens.

Do not place objects in front of the lens while the projector is being used.

Doing so can cause fire, damage to an object, or malfunction of the projector.

- Strong light is emitted from the projector's lens.

Never plug headphones and earphones into <VARIABLE AUDIO OUT> terminal.

Excessive sound pressure from headphones and earphones can cause hearing loss.

Always disconnect all cables before moving the projector.

Moving the projector with cables still attached can damage the cables, which will cause fire or electric shocks to occur.

When mounting the projector on the ceiling, keep mounting screws and power cord from contact with metal parts inside the ceiling.

Contact with metal parts inside the ceiling can cause electric shocks.

■ ACCESSORIES

When not using the projector for an extended period of time, remove the batteries from the remote control.

Failure to observe this will cause the batteries to leak, overheat, catch fire or explode, which may result in fire or contamination of surrounding area.

■ MAINTENANCE

Ask your dealer about cleaning inside the projector every 20 000 hours of usage as an estimated duration.

Continuous use while dust is accumulated inside the projector may result in fire.

- For cleaning fee, ask your dealer.

To remove the battery

Remote Control Battery

1. Press the guide and lift the cover.

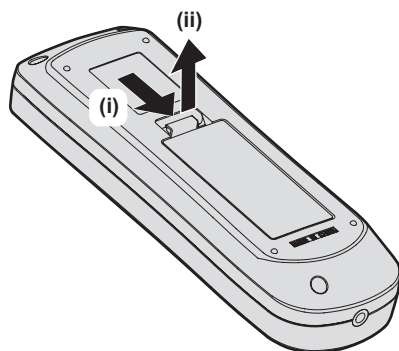

2. Remove the batteries.

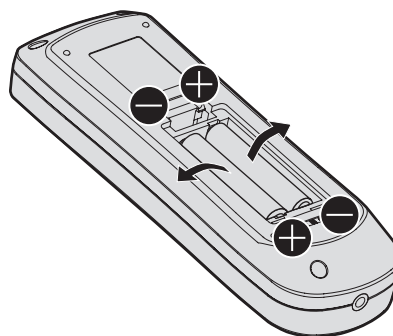

Brazil Only Brasil Apenas

■ Manuseio de baterias usadas



BRASIL

Após o uso, as pilhas e/ou baterias deverão ser entregues ao estabelecimento comercial ou rede de assistência técnica autorizada.

Cobrir os terminais positivo (+) e negativo (-) com uma fita isolante adesiva, antes de depositar numa caixa destinada para o recolhimento. O contato entre partes metálicas pode causar vazamentos, gerar calor, romper a blindagem e produzir fogo. (Fig. 1)

Fig. 1
Como isolar os terminais

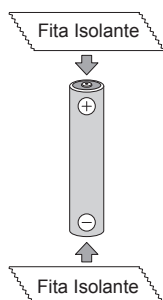

Não desmonte, não remova o invólucro, nem amasse a bateria. O gás liberado pela bateria pode irritar a garganta, danificar o lacre do invólucro ou o vazamento provocar calor, ruptura da blindagem e produzir fogo devido ao curto circuito dos terminais. Não incinere nem aqueça as baterias, elas não podem ficar expostas a temperaturas superiores a 100 °C (212 °F). O gás liberado pela bateria pode irritar a garganta, danificar o lacre do invólucro ou o vazamento provocar calor, ruptura da blindagem e produzir fogo devido ao curto circuito dos terminais provocado internamente.

Evite o contato com o líquido que vazar das baterias. Caso isto ocorra, lave bem a parte afetada com bastante água. Caso haja irritação, consulte um médico.

■ Remoção das baterias

1. Pressione a guia e levante a tampa.

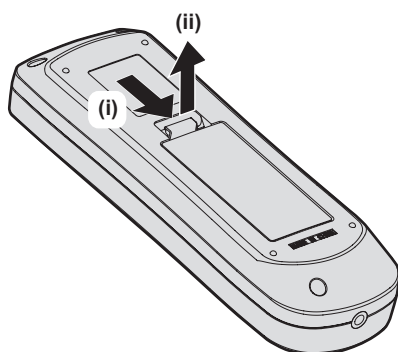

2. Remova as baterias.

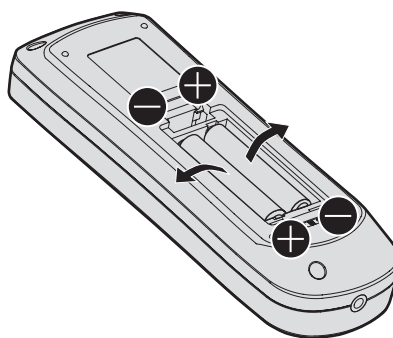

■ Trademarks

- SOLID SHINE is a trademark of Panasonic Corporation.
- Windows and Internet Explorer are registered trademarks or trademarks of Microsoft Corporation in the United States and other countries.
- Mac, Mac OS, and Safari are trademarks of Apple Inc., registered in the United States and other countries.
- PJLink™ is a registered trademark or pending trademark in Japan, the United States, and other countries and regions.
- HDMI, the HDMI Logo, and High-Definition Multimedia Interface are trademarks or registered trademarks of HDMI Licensing LLC in the United States and other countries.
- RoomView and Crestron RoomView are registered trademarks of Crestron Electronics, Inc. Crestron Connected™ and Fusion RV are trademarks of Crestron Electronics, Inc.
- HDBaseT™ is a trademark of HDBaseT Alliance.
- Art-Net™ Designed by and Copyright Artistic Licence Holdings Ltd
- Adobe, Adobe Flash Player, and Adobe Reader are trademarks or registered trademarks of Adobe Systems Inc. in the United States and/or other countries.
- Some of the fonts used in the on-screen menu are Ricoh bitmap fonts, which are manufactured and sold by Ricoh Company, Ltd.
- All other names, company names, and product names mentioned in this manual are trademarks or registered trademarks of their respective owners.
Please note that the ® and ™ symbols are not specified in this manual.

■ Illustrations in this manual

- Illustrations of the projector, screen, and other parts may vary from the actual product.
- Illustrations of the projector with the power cord attached are only examples. The shape of the supplied power cords varies depending on the country where you purchased the product.

■ Reference pages

- Reference pages in this manual are indicated as (➔ page 00).

■ Term

- In this manual, the “Wireless remote control unit” accessory is referred to as “Remote control”.

Features of the Projector

High luminance and high contrast

- ▶ With a unique optical system which uses a new-generation laser light source, and the laser light source drive system, high luminance of 5 200 lm and high contrast of 20 000:1 are achieved even with its compact size.

Easy and highly flexible setup

- ▶ In addition to 2x zoom lens and lens shift, support for wide range of interfaces (such as DIGITAL LINK and Art-Net) and 360° installation support utilizing the characteristics of solid-state light source allow usage for wide range of application.

Long life and high reliability

- ▶ The maintenance cost for long-term operation is reduced by the unique light source cooling control technology and improvement of the dust resistance.

Quick Steps

For details, refer to the corresponding pages.

1. **Set up the projector.**
(⇒ page 30)



2. **Connect with external devices.**
(⇒ page 34)



3. **Connect the power cord.**
(⇒ page 40)



4. **Switch on the projector.**
(⇒ page 41)



5. **Make initial settings.**
(⇒ page 42)
 - Take this step when you switch on the power for the first time after purchasing the projector.



6. **Select the input signal.**
(⇒ page 47)



7. **Adjust the image.**
(⇒ page 48)

Chapter 1 Preparation

This chapter describes things you need to know or check before using the projector.

Precautions for use

Lens protection material

Lens protection material is attached to the product at the time of purchase to protect the projection lens from the vibration during transport. Remove the lens protection material before use.

■ Removing the lens protection material

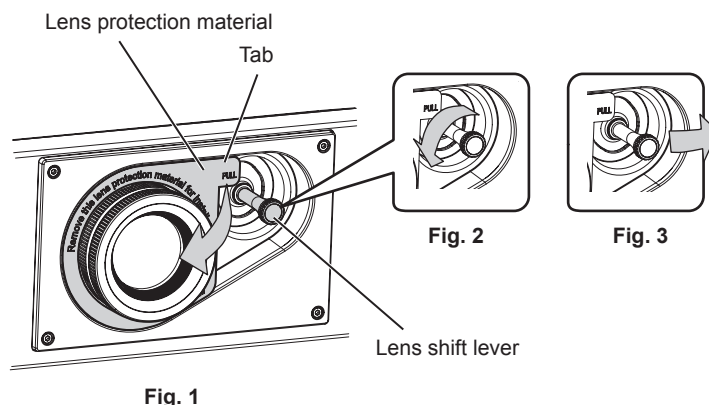

- 1) Turn the lens shift lever counterclockwise, and release the fixing. (Fig. 2)
- 2) Hold the tab of the lens protection material and remove the lens protection material by pulling in the direction of the arrow. (Fig. 1)
 - Move the lens shift lever to right when it is difficult to remove the lens protection material. (Fig. 3)

Cautions when transporting

- When transporting the projector, hold it securely by its bottom and avoid excessive vibration and impacts. They may damage the internal components and result in malfunctions.
- Do not transport the projector with the adjustable feet extended. Doing so may damage the adjustable feet.

Cautions when installing

■ Do not set up the projector outdoors.

The projector is designed for indoor use only.

■ Do not set up the projector in the following locations.

- Places where vibration and impacts occur such as in a car or vehicle: Doing so may cause damage to internal components or malfunction.
- Location close to sea or where corrosive gas may occur: The projector may fall due to corrosion. Also, failure to do so may shorten the life of the components and result in malfunction.
- Near the exhaust of an air conditioner: Depending on the conditions of use, the screen may fluctuate in rare cases due to the heated air from the air exhaust port or the hot or cooled air from the air conditioner. Make sure that the exhaust from the projector or other equipment, or the air from the air conditioner does not blow toward the front of the projector.
- Places with sharp temperature fluctuations such as near lights (studio lamps): Doing so may shorten the life of the light source, or result in deformation of the projector due to heat, which may cause malfunctions.
Follow the operating environment temperature of the projector.
- Near high-voltage power lines or near motors: Doing so may interfere with the operation of the projector.
- Places where there is high-power laser equipment: Directing a laser beam onto the projection lens surface causes damage to the DLP chips.

■ **Be sure to ask a specialized technician or your dealer when installing the projector on a ceiling.**

The optional Ceiling Mount Bracket is required.

Model No.: ET-PKD120H (for High Ceilings), ET-PKD120S (for Low Ceilings), ET-PKD130B (Projector Mount Bracket)

■ **Ask a qualified technician or your dealer to install the cable wiring for DIGITAL LINK connection.**

Image and sound may be disrupted if cable transmission characteristics cannot be obtained due to inadequate installation.

■ **The projector may not work properly due to strong radio wave from the broadcast station or the radio.**

If there is any facility or equipment which outputs strong radio waves near the installation location, install the projector at a location sufficiently far from the source of the radio waves. Or, wrap the LAN cable connected to the <DIGITAL LINK/LAN> terminal using a piece of metal foil or a metal pipe which is grounded at both ends.

■ **Focus adjustment**

The high clarity projection lens is thermally affected by the light from the light source, making the focus unstable in the period just after switching on the power. It is recommended that images be projected continuously for at least 30 minutes before the focus is adjusted.

■ **Do not install the projector at an altitude of 4 200 m (13 780') or higher above sea level.**

■ **Do not use the projector in a location that the ambient temperature exceeds 45 °C (113 °F).**

Using the projector in a location that the altitude is too high or the ambient temperature is too high may reduce the life of the components or result in malfunctions.

The upper limit of the operating environment temperature differs depending on the altitude or the setting of the [PROJECTOR SETUP] menu → [ECO MANAGEMENT] → [OPERATING MODE].

Altitude above sea level	Setting for [OPERATING MODE]	
	[NORMAL], [USER]	[ECO], [SILENT]
Altitude of 0 m (0') or higher to lower than 1 400 m (4 593')	0 °C (32 °F) to 45 °C (113 °F)	
Altitude of 1 400 m (4 593') or higher to lower than 2 700 m (8 858')	0 °C (32 °F) to 40 °C (104 °F)	
Altitude of 2 700 m (8 858') or higher to lower than 4 200 m (13 780')	0 °C (32 °F) to 40 °C (104 °F)	The projector cannot be used.

■ **Projection in all 360° direction is possible.**

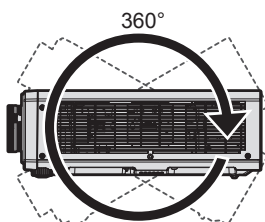

360° vertically

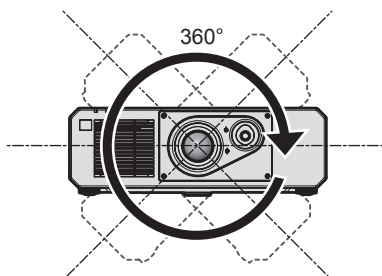

360° horizontally

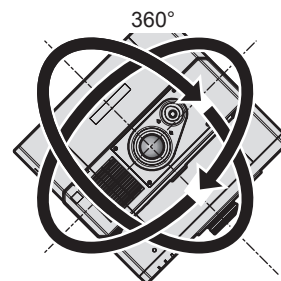

360° tilted
(combination of vertical and horizontal)

■ **Cautions when setting up the projector**

- Use the adjustable feet only for the floor standing installation and for adjusting the angle. Using them for other purposes may damage the projector.

- When installing the projector with a method other than the floor installation using the adjustable feet or the ceiling installation, use the five screw holes for ceiling mount (as shown in the figure) to fix the projector to the mount.

(Screw diameter: M6, tapping depth inside the projector: 15 mm (19/32"), torque: 4 ± 0.5 N·m)

In such case, make sure that there is no clearance between the screw holes for ceiling mount on the projector bottom and the setting surface by inserting spacers (metallic) between them.

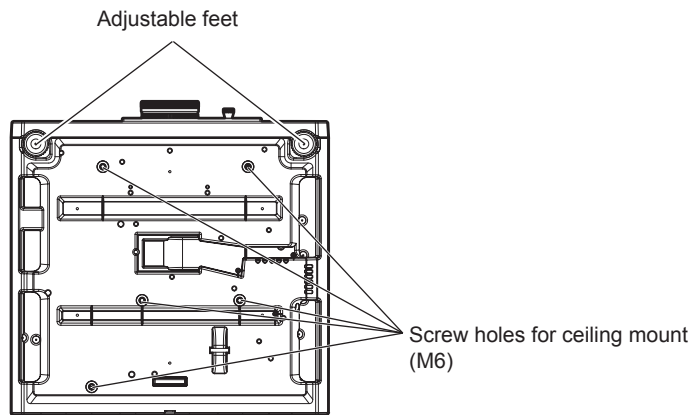

Positions of screw holes for ceiling mount and adjustable feet

- Do not stack projectors on top of each other.
- Do not use the projector supporting it by the top.
- Do not block the ventilation ports (intake and exhaust) of the projector.
- Prevent hot and cool air from the air conditioning system to blow directly to the ventilation ports (intake and exhaust) of the projector.

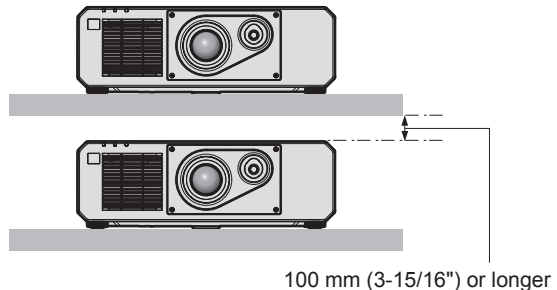
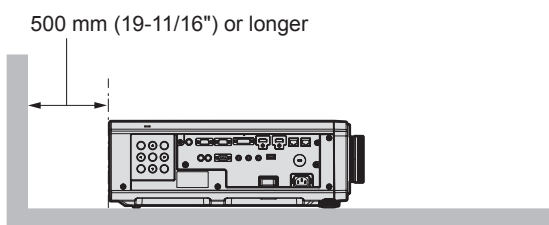
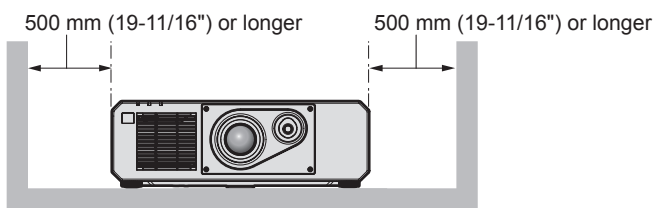
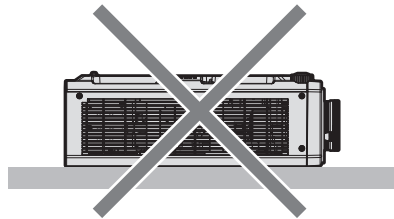
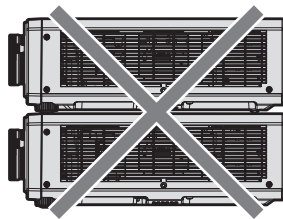

- Do not install the projector in a confined space.
When installing the projector in a confined space, provide air conditioning or ventilation separately. Exhaust heat may accumulate when the ventilation is not enough, triggering the protection circuit of the projector.

Security

When using this product, take safety measures against the following incidents.

- Personal information being leaked via this product
- Unauthorized operation of this product by a malicious third party

- Interfering or stopping of this product by a malicious third party

Take sufficient security measures.

- Make your password difficult to guess as much as possible.
- Change your password periodically. A password can be set in the [SECURITY] menu → [SECURITY PASSWORD CHANGE].
- Panasonic Corporation or its affiliate companies will never ask for your password directly. Do not divulge your password in case you receive such inquiries.
- The connecting network must be secured by a firewall, etc.
- Set a password for the web control and restrict the users who can log in. A password for the web control can be set in the [Change password] page of the web control screen.

DIGITAL LINK

“DIGITAL LINK” is a technology to transmit the video, audio, Ethernet, and serial control signals using a twisted pair cable by adding unique functions by Panasonic to the HDBaseT™ communication standard formulated by HDBaseT Alliance.

This projector supports the optional Panasonic DIGITAL LINK output supported device (Model No.: ET-YFB100G, ET-YFB200G) and peripheral devices by other manufacturers (twisted-pair-cable transmitters such as the “XTP transmitter” of Extron Electronics) that use the same HDBaseT™ standard. For the devices of other manufacturers that the operation has been verified with this projector, visit the Panasonic website (<http://panasonic.net/avc/projector/>). Note that the verification for devices of other manufacturers has been made for the items set by Panasonic Corporation, and not all the operations have been verified. For operation or performance problems caused by the devices of other manufacturers, contact the respective manufacturers.

Art-Net

“Art-Net” is an Ethernet communication protocol based on the TCP/IP protocol.

By using the DMX controller and the application software, illumination and stage system can be controlled. Art-Net is made based on DMX512 communication protocol.

Early Warning Software

The projector supports “Early Warning Software”, which monitors the status of the display (projector or flat panel display) and the peripheral devices inside an intranet, and notifies of abnormality of such equipment and detects signs of possible abnormality. Also, maintenance can be performed in advance, because this software gives notification of approximate time to replace consumables of the display, to clean each part of the display, and to replace the components of the display.

Depending on the type of license, the number of displays that can be registered for monitoring varies. Limited to the first 90 days after installation in a computer, it is possible to register up to 2048 units of displays free of charge. Download the software from the Panasonic website (<http://panasonic.net/avc/projector/pass/>). It is necessary to register and login to PASS*1 to download.

*1 PASS: Panasonic Professional Display and Projector Technical Support Website
Visit the Panasonic website (<http://panasonic.net/avc/projector/pass/>) for details.

Disposal

To dispose of the product, ask your local authorities or dealer for correct methods of disposal.

Cautions on use

■ To get a good picture quality

In order to view a beautiful image in higher contrast, prepare an appropriate environment. Draw curtains or blinds over windows and turn off any lights near the screen to prevent outside light or light from indoor lamps from shining onto the screen.

■ Do not touch the surface of the projection lens with your bare hands.

If the surface of the projection lens becomes dirty from fingerprints or anything else, this will be magnified and projected onto the screen.

■ DLP chips

- The DLP chips are precision-made. Note that in rare cases, pixels of high precision could be missing or always lit. Such a phenomenon does not indicate malfunction.

- Directing a high-power laser beam onto the projection lens surface can damage the DLP chips.

■ Light source

The light source of the projector uses lasers, and has the following characteristics.

- Depending on the operating environment temperature, the luminance of the light source will decrease.
The higher the temperature becomes, the more the luminance of the light source decreases.

- The luminance of the light source will decrease by duration of usage.

The time until when the luminance of the light source decreases by half differs depending on the setting of the [PROJECTOR SETUP] menu → [ECO MANAGEMENT] → [OPERATING MODE].

The estimated time until when the luminance of the light source decreases by half is as follows.

(The time is estimated when the [PICTURE] menu → [DYNAMIC CONTRAST] is set to [ON].)

– When [OPERATING MODE] is set to [NORMAL] or [SILENT]: Approximately 20 000 hours

– When [OPERATING MODE] is set to [ECO]: Approximately 24 000 hours

This time is rough estimate when the projector is used without changing the [OPERATING MODE] setting, and will vary depending on individual difference and usage condition.

If brightness is noticeably reduced and the light source does not turn on, ask your dealer to clean inside the projector or replace the light source unit.

■ Computer and external device connections

When connecting a computer or an external device, read this manual carefully regarding the use of power cords and shielded cables as well.

Accessories

Make sure that the following accessories are provided with your projector. Numbers enclosed in < > show the number of accessories.

Wireless remote control unit <1>
(N2QAYA000126)



(TXFSX01RWDZ)

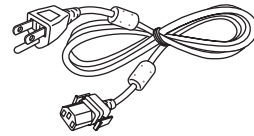

(TXFSX02UTRZ)

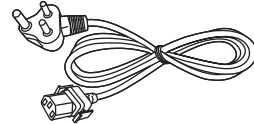

Power cord
(TXFSX01RXQZ)

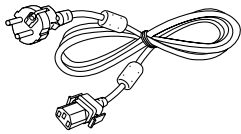

(TXFSX01RXRZ)

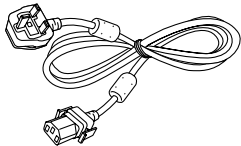

CD-ROM <1>
(TXFQB02XKPZ)



AAA/R03 or AAA/LR03 battery <2>

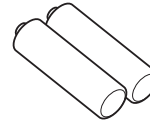

(For remote control unit)

Attention

- After unpacking the projector, discard the power cord cap and packaging material properly.
- Do not use the supplied power cord for devices other than this projector.
- For missing accessories, consult your dealer.
- Store small parts in an appropriate manner, and keep them away from small children.

Note

- The type and number of the supplied power cords vary depending on the country or region where you purchased the product.
- The model numbers of accessories are subject to change without prior notice.

Contents of the supplied CD-ROM

The contents of the supplied CD-ROM are as follows.

Instruction/list (PDF)	Operating Instructions – Functional Manual	
	Multi Monitoring & Control Software Operating Instructions	
	Logo Transfer Software Operating Instructions	
	List of Compatible Device Models	This is a list of display models (projector or flat panel display) that are compatible with the software contained in the CD-ROM and their restrictions.
Software	Multi Monitoring & Control Software (Windows)	This software allows you to monitor and control multiple displays (projector or flat panel display) connected to the LAN.
	Logo Transfer Software (Windows)	This software allows you to transfer original images, such as company logos to be displayed when projection starts, to the projector.

Optional accessories

Optional accessories (product name)	Model No.
Ceiling Mount Bracket	ET-PKD120H (for High Ceilings) ET-PKD120S (for Low Ceilings) ET-PKD130B (Projector Mount Bracket)
Early Warning Software (Basic license/3-year license)	ET-SWA100 Series*1
Digital Interface Box	ET-YFB100G
DIGITAL LINK Switcher	ET-YFB200G
D-SUB - S Video conversion cable	ET-ADSV

*1 The suffix of the Model No. differs according to the license type.

Note

- The model numbers of optional accessories are subject to change without prior notice.

About your projector

Remote control

■ Front

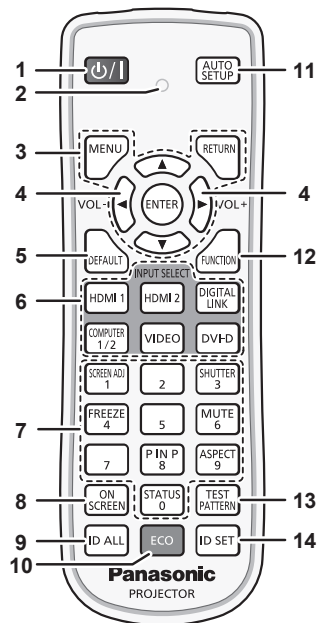

■ Top

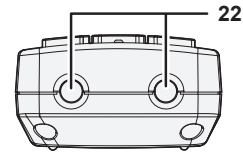

■ Bottom

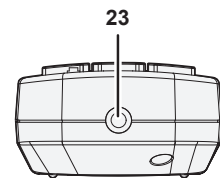
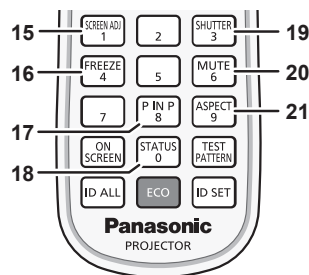

1 Power <P> button

Sets the projector to the state where the projector is turned off (standby mode) when the <MAIN POWER> switch on the projector is set to <ON> and in projection mode. Sets the projector to projection mode when the power is switched off (standby mode).

2 Remote control indicator

Blinks if any button in the remote control is pressed.

3 <MENU> button/<RETURN> button/<ENTER> button/▲▼◀▶ buttons

Used to navigate through the menu screen. (➔ page 57) ▲▼◀▶ buttons are also used to enter the password in [SECURITY] or enter characters.

4 <VOL-> button/<VOL+> button

Adjusts the volume of audio output. (➔ page 51)

5 <DEFAULT> button

Resets the content of the sub-menu to the factory default. (➔ page 58)

6 Input selection buttons (<HDMI 1>, <HDMI 2>, <DIGITAL LINK>, <COMPUTER 1/2>, <VIDEO>, <DVI-D>)

Switches the input signal to project. (➔ page 47)

7 Number (<0> - <9>) buttons

Used for entering an ID number or a password in a multiple projector environment.

8 <ON SCREEN> button

Switches the on-screen display function on (display) or off (hide). (➔ page 51)

9 <ID ALL> button

Used to simultaneously control all the projectors with a single remote control in a multiple projector environment. (➔ page 28)

10 <ECO> button

Displays the setting screen relating to ECO management. (➔ pages 54, 96)

11 <AUTO SETUP> button

Automatically adjusts the image display position while projecting the image. [PROGRESS] is displayed while in automatic adjustment. (➔ page 52)

12 <FUNCTION> button

Assigns a frequently used operation as a shortcut button. (➔ page 53)

13 <TEST PATTERN> button

Displays the test pattern. (➔ page 53)

14 <ID SET> button

Sets the ID number of the remote control in a multiple projector environment. (➔ page 28)

15 <SCREEN ADJ> button

Used to correct the distortion of the projected image. (➔ pages 52, 70)

16 <FREEZE> button

Used when pausing the image and turning off the audio. (➔ page 51)

17 <P IN P> button

Switches the picture in picture function setting. (➔ page 53)

18 <STATUS> button

Displays the projector information.

19 <SHUTTER> button

Used when temporarily turning off the image and audio. (➔ page 50)

20 <MUTE> button

Used when temporarily turning off the audio. (➔ page 50)

21 <ASPECT> button

Switches the aspect ratio of the image. (➔ page 53)

22 Remote control signal transmitter

23 (Not available with this projector)

Attention

- Do not drop the remote control.
- Avoid contact with liquids or moisture.
- Do not attempt to modify or disassemble the remote control.

- Observe the following instructions that are indicated on the caution label at the back of the remote control:
 - Do not use old battery with new one.
 - Do not use batteries other than the type specified.
 - Be sure the batteries are inserted properly.
- For other instructions, read the instructions related to batteries that are described in "Read this first!".

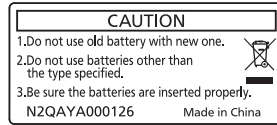

Caution label at the back of the remote control

Note

- When operating the remote control by directly pointing at the remote control signal receiver of the projector, operate the remote control within a distance approximately 30 m (98'5") from the remote control signal receiver. The remote control can control at angles of up to $\pm 30^\circ$ vertically and horizontally, but the effective control range may be reduced.
- If there are any obstacles between the remote control and the remote control signal receiver, the remote control may not operate properly.
- The signal will be reflected off the screen. However, the operating range may be limited from light reflection loss due to the screen material.
- If the remote control signal receiver directly receives strong light, such as fluorescent light, the remote control may not operate properly. Use it in a place distant from the light source.
- The power indicator <ON (G)/STANDBY (R)> will blink if the projector receives a remote control signal.

Projector body

■ Front

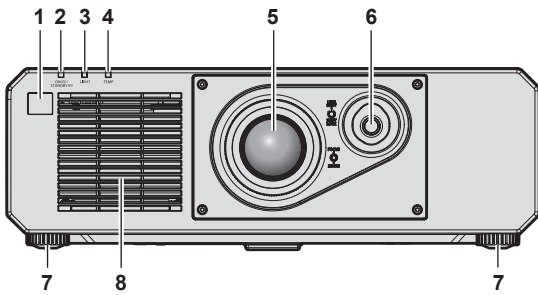

■ Side

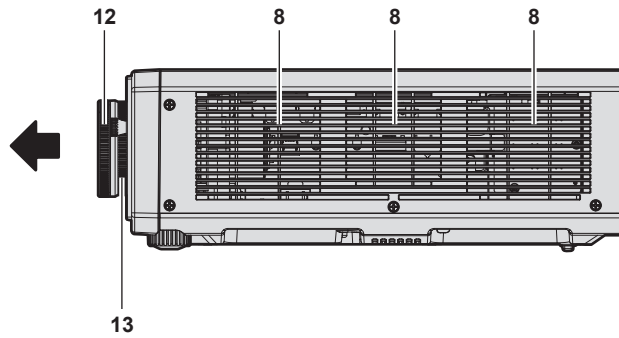

■ Rear

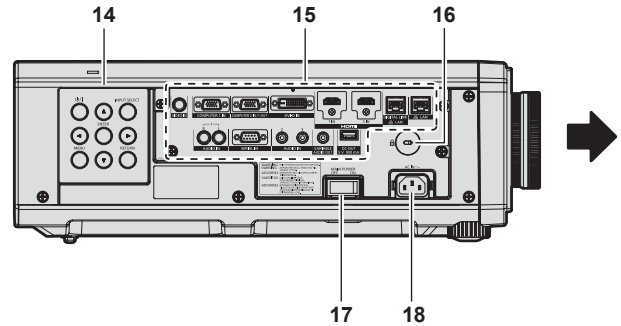
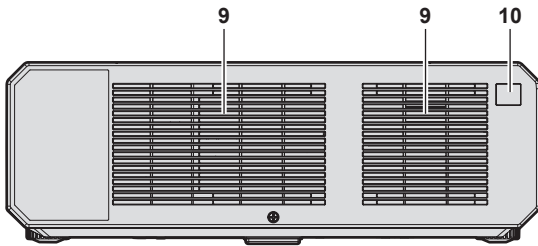

■ Top

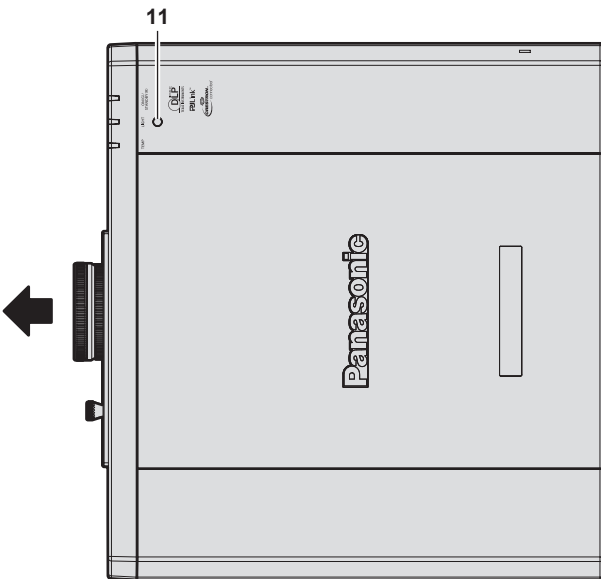

■ Bottom

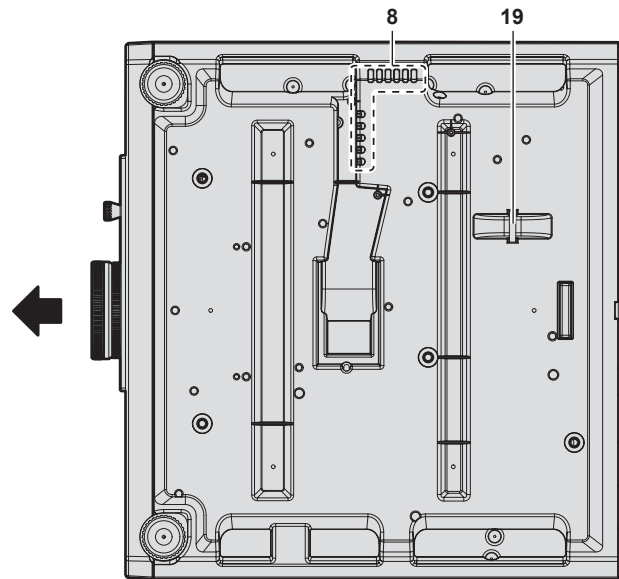

← : Projection direction

- 1 Remote control signal receiver (front)
- 2 Power indicator <ON (G)/STANDBY (R)>
Indicates the status of the power.
- 3 Light source indicator <LIGHT>
Indicates the status of the light source.
- 4 Temperature indicator <TEMP>
Indicates the internal temperature status.
- 5 Projection lens
- 6 Lens shift lever
Adjusts the projection position.
- 7 Adjustable feet
Adjusts the projection angle.
- 8 Air intake port
- 9 Air exhaust port

- 10 Remote control signal receiver (rear)
- 11 Luminance sensor
This is a sensor to detect the luminance of the installed environment.
When the [PICTURE] menu → [DAYLIGHT VIEW] is set to [AUTO], the luminance of the installed environment is detected by the luminance sensor to automatically perform appropriate picture quality correction.
- 12 Focus ring
Adjusts the focus.
- 13 Zoom ring
Adjusts the zoom.
- 14 Control panel (⇒ page 27)
- 15 Connecting terminals (⇒ page 27)

16 Security slot

This security slot is compatible with the Kensington security cables.

17 <MAIN POWER> switch

Turns on/off the main power.

18 <AC IN> terminal

Connect the supplied power cord.

19 Burglar hook port

Attaches a burglar prevention cable, etc.

Attention

- Do not block the ventilation ports (intake and exhaust) of the projector.

Control panel

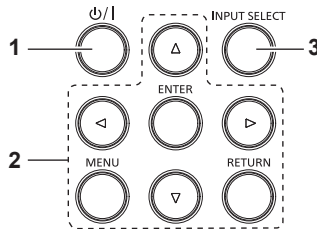

1 Power $\phi/|$ button

Sets the projector to the state where the projector is turned off (standby mode) when the <MAIN POWER> switch on the projector is set to <ON> and in projection mode. Sets the projector to projection mode when the power is switched off (standby mode).

2 <MENU> button/<RETURN> button/<ENTER> button/ $\triangle$$\nabla$$\leftarrow$$\rightarrow$ buttons

Used to navigate through the menu screen. Also used to enter a password in the [SECURITY] menu or enter characters.

3 <INPUT SELECT> button

Switches the input signal to project. (➔ page 47)

Connecting terminals

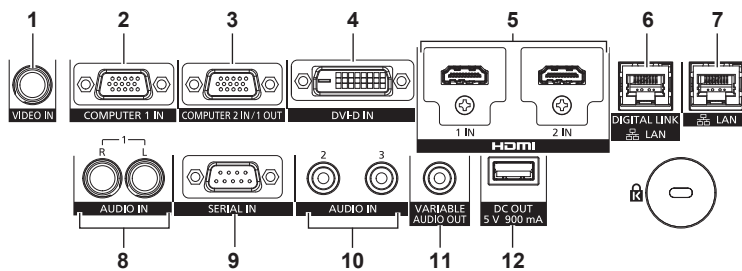

1 <VIDEO IN> terminal

This is a terminal to input video signal.

2 <COMPUTER 1 IN> terminal

This is a terminal to input the RGB signal, YC_BC_R/YP_BP_R signal, or Y/C signal.

3 <COMPUTER 2 IN/1 OUT> terminal

This is a terminal to input the RGB signal or YC_BC_R/YP_BP_R signal. Also, the RGB signal or YC_BC_R/YP_BP_R signal input to the <COMPUTER 1 IN> terminal can be output to an external device. Video signal is output when the input is switched to COMPUTER1.

4 <DVI-D IN> terminal

This is a terminal to input the DVI-D signal.

5 <HDMI 1 IN> terminal/<HDMI 2 IN> terminal

This is a terminal to input the HDMI signal.

6 <DIGITAL LINK/LAN> terminal

This is a terminal to connect a device that transmits video signal or audio signal via the LAN terminal. Also, this is the LAN terminal to connect to the network.

7 <LAN> terminal

This is the LAN terminal to connect to the network.

8 <AUDIO IN 1> terminal

This is a terminal to input audio signal. There are right input <R> and left input <L>.

9 <SERIAL IN> terminal

This is the RS-232C compatible terminal to externally control the projector by connecting a computer.

10 <AUDIO IN 2> terminal/<AUDIO IN 3> terminal

This is a terminal to input audio.

11 <VARIABLE AUDIO OUT> terminal

This is a terminal to output the audio signal input to the projector.

12 <DC OUT> terminal

This is the USB terminal dedicated for power supply. (DC5 V, maximum 900 mA)

This can be used when a power is needed to be supplied to a wireless display adaptor, etc.

Attention

- When a LAN cable is directly connected to the projector, the network connection must be made indoors.

Preparing the remote control

Inserting and removing the batteries

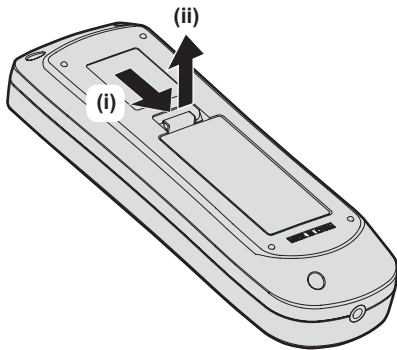

Fig. 1

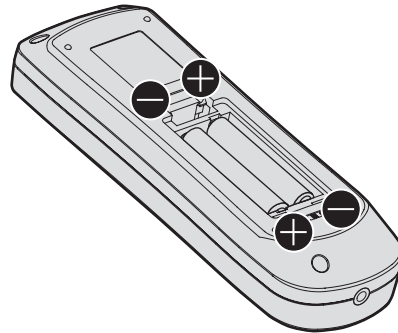

Fig. 2

- 1) **Open the cover. (Fig. 1)**
- 2) **Insert the batteries and close the cover (insert the \ominus side first). (Fig. 2)**
 - When removing the batteries, perform the steps in reverse order.

When using the multiple projectors

When you use the multiple projectors together, you can operate all the projectors simultaneously or each projector individually using single remote control, if a unique ID number is assigned to each projector.

When using the projectors by setting the ID numbers, set the ID number of the projector body after initial settings have been completed. Then, set the ID number of the remote control. For initial settings, refer to “When the initial setting screen is displayed” (➔ page 42).

The factory default ID number of the projector (projector body and remote control) is set to [ALL], so you can use it as it is. Set the ID numbers of the projector body and remote control as necessary.

For details on setting the ID number of the remote control, refer to “Setting ID number of the remote control” (➔ page 54).

Note

- Set the ID number of the projector body from the [PROJECTOR SETUP] menu → [PROJECTOR ID].

Chapter 2 **Getting Started**

This chapter describes things you need to do before using the projector such as the setup and connections.

Setting up

Installation mode

The installation modes of the projector are as follows. Set [FRONT/REAR]/[FLOOR/CEILING] in the [PROJECTOR SETUP] menu → [PROJECTION METHOD] (► page 95) depending on the installation mode.

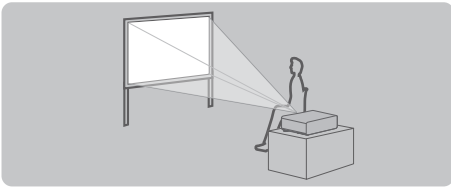
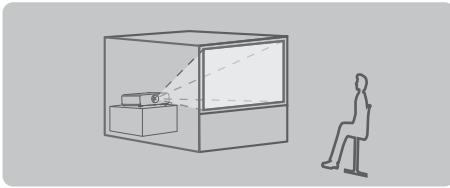
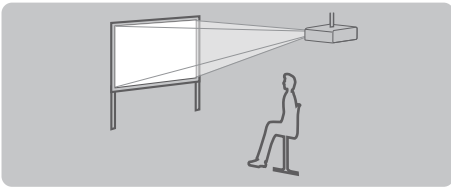
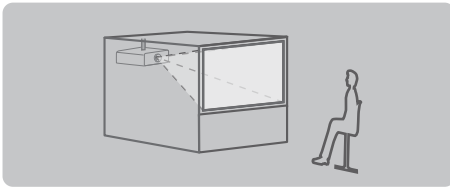
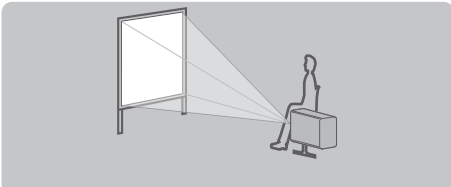
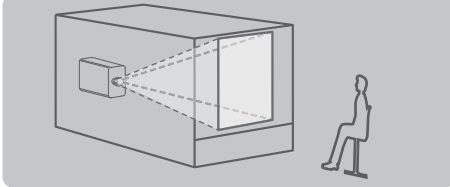
Setting on a desk/floor and projecting forward 		Setting on a desk/floor and projecting from rear (Using the translucent screen) 	
Menu item	Setting value	Menu item	Setting value
[FRONT/REAR]	[FRONT]	[FRONT/REAR]	[REAR]
[FLOOR/CEILING]	[AUTO] or [FLOOR]	[FLOOR/CEILING]	[AUTO] or [FLOOR]
Mounting on the ceiling and projecting forward 		Mounting on the ceiling and projecting from rear (Using the translucent screen) 	
Menu item	Setting value	Menu item	Setting value
[FRONT/REAR]	[FRONT]	[FRONT/REAR]	[REAR]
[FLOOR/CEILING]	[AUTO] or [CEILING]	[FLOOR/CEILING]	[AUTO] or [CEILING]
Portrait setting and projecting forward 		Portrait setting and projecting from rear (Using the translucent screen) 	
Menu item	Setting value	Menu item	Setting value
[FRONT/REAR]	[FRONT]	[FRONT/REAR]	[REAR]
[FLOOR/CEILING]	Set in accordance with the image to project.	[FLOOR/CEILING]	Set in accordance with the image to project.

Note

- In the portrait setting, the on-screen menu is displayed sideways. To display the on-screen menu vertically, go to the [DISPLAY OPTION] menu → [ON-SCREEN DISPLAY] (► page 87) and change the [OSD ROTATION] setting.
- The projector has a built-in angle sensor. The attitude of the projector is automatically detected by setting [FLOOR/CEILING] to [AUTO] in the [PROJECTOR SETUP] menu → [PROJECTION METHOD].

■ Angle sensor

The range of the installation attitude that is detected by the angle sensor built-in the projector is as follows.

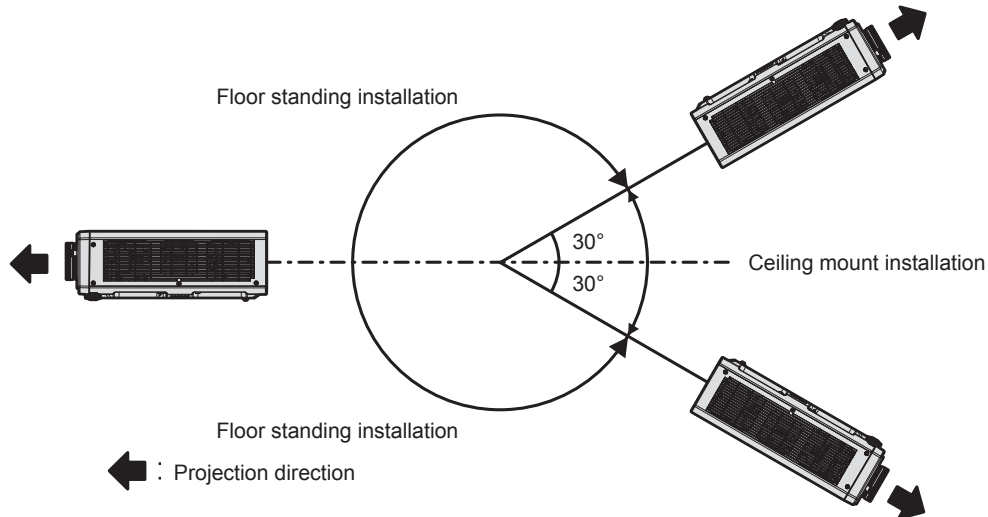

Parts for installation (optional)

The projector can be installed on the ceiling by combining the optional Ceiling Mount Bracket (Model No.: ET-PKD120H (for High Ceilings), ET-PKD120S (for Low Ceilings)) and Ceiling Mount Bracket (Model No.: ET-PKD130B (Projector Mount Bracket)).

- Be sure to use the Ceiling Mount Bracket specified for this projector.
- Refer to the Installation Instructions of the Ceiling Mount Bracket when installing and setting up the projector.

Attention

- To ensure projector performance and security, installation of the Ceiling Mount Bracket must be carried out by your dealer or a qualified technician.

Projected image and throw distance

Install the projector referring to the projected image size and projection distance. Image size and image position can be adjusted in accordance with the screen size and screen position.

- Following illustration is prepared on the assumption that the projected image size and position have been aligned to fit full in the screen.

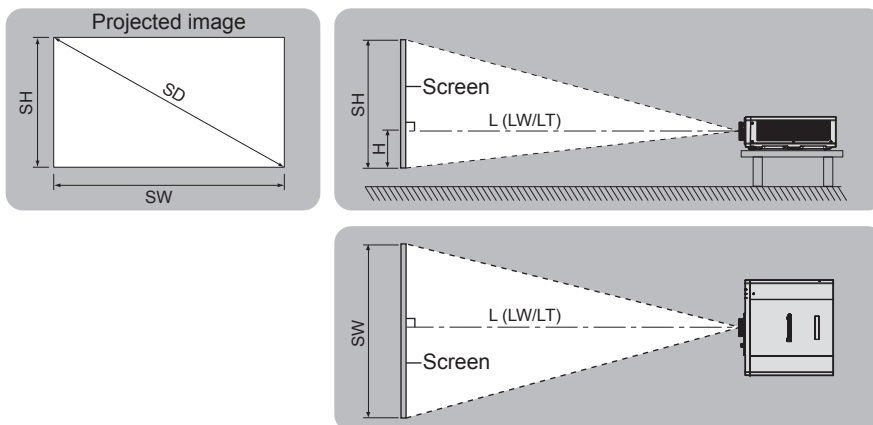

(Unit: m)

L (LW/LT)*1	Projection distance
SH	Projected image height
SW	Projected image width
H	Distance from the lens center to the bottom edge of the projected image
SD	Projected image size

*1 LW: Minimum projection distance
 LT: Maximum projection distance

Attention

- Before setting up, read “Precautions for use” (➔ page 17).
- Do not use the projector and the high-powered laser equipment in the same room. The DLP chips can be damaged if a laser beam hits the projection lens surface.

[SCREEN ADJUSTMENT] projection range

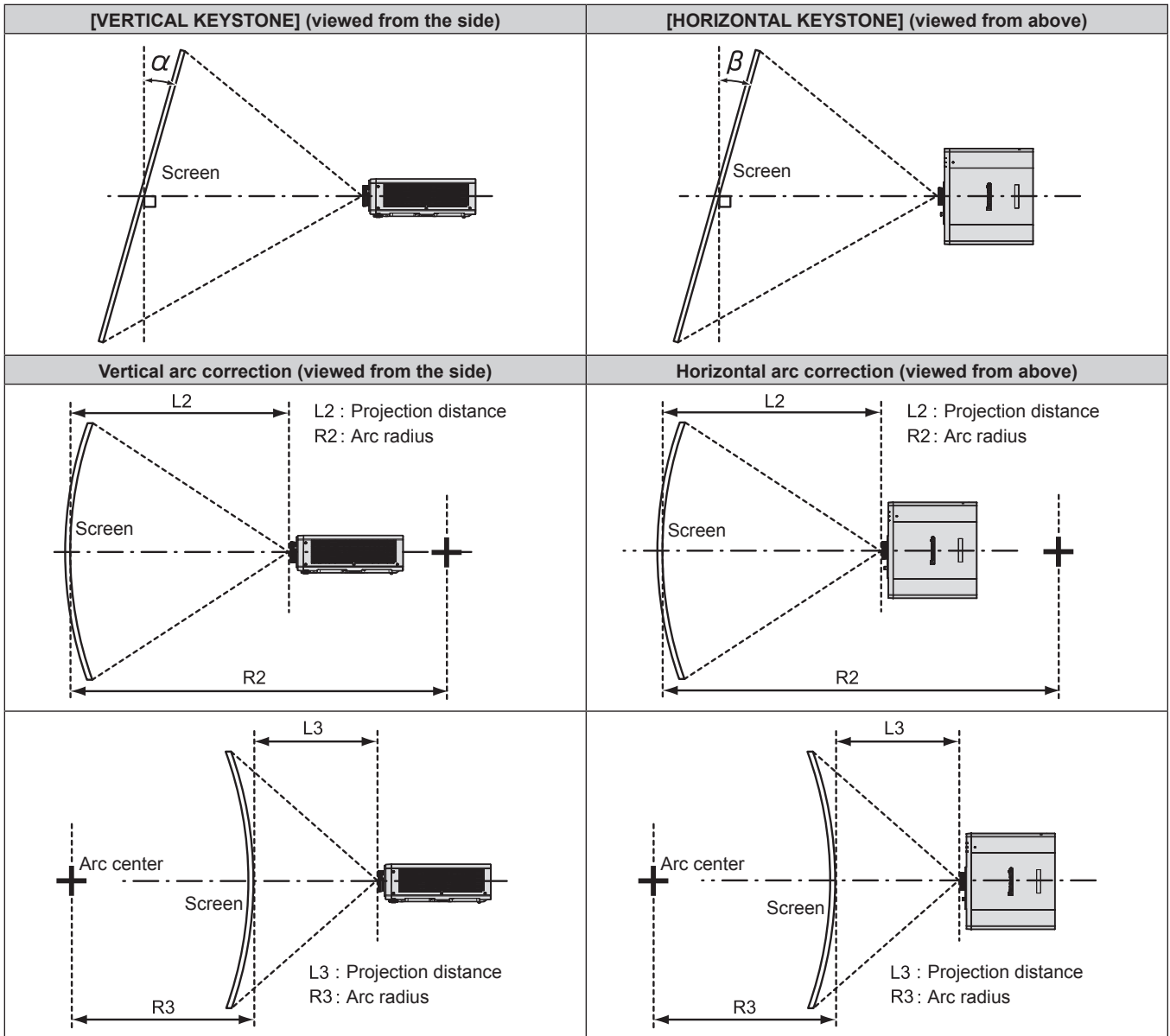

Only [KEYSTONE] used		[KEYSTONE] and [CURVED CORRECTION] used together				Only [CURVED CORRECTION] used	
Vertical keystone correction angle α (°)	Horizontal keystone correction angle β (°)	Vertical keystone correction angle α (°)	Horizontal keystone correction angle β (°)	Min. value of R2/L2	Min. value of R3/L3	Min. value of R2/L2	Min. value of R3/L3
±40	±20	±20	±15	0.9	1.7	0.5	1.0

Note

- When [SCREEN ADJUSTMENT] is used, the focus of the entire screen may be lost as correction increases.
- Make the curved screen a circular arc shape with one part of a perfect circle removed.

Projection distance

A ±5 % error in listed projection distances may occur.

When [SCREEN ADJUSTMENT] is used, distance is corrected to become smaller than the specified image size.

(Unit: m)

Projected image size Diagonal (SD)	Aspect ratio 16:10			Aspect ratio 16:9			Aspect ratio 4:3		
	Projection distance (L)		Height position (H)	Projection distance (L)		Height position (H)	Projection distance (L)		Height position (H)
	Min. (LW)	Max. (LT)		Min. (LW)	Max. (LT)		Min. (LW)	Max. (LT)	
1.02 (40")	1.22	2.51	-0.08 - 0.51	1.26	2.58	-0.07 - 0.47	1.39	2.85	-0.09 - 0.58
1.27 (50")	1.54	3.15	-0.09 - 0.63	1.59	3.23	-0.09 - 0.59	1.75	3.57	-0.11 - 0.72
1.52 (60")	1.86	3.78	-0.11 - 0.76	1.92	3.89	-0.10 - 0.70	2.12	4.29	-0.13 - 0.86
1.78 (70")	2.18	4.42	-0.13 - 0.89	2.24	4.55	-0.12 - 0.82	2.48	5.01	-0.15 - 1.00
2.03 (80")	2.50	5.06	-0.15 - 1.01	2.57	5.20	-0.14 - 0.94	2.84	5.73	-0.17 - 1.14
2.29 (90")	2.82	5.70	-0.17 - 1.14	2.90	5.86	-0.16 - 1.06	3.20	6.46	-0.19 - 1.29
2.54 (100")	3.14	6.34	-0.19 - 1.27	3.23	6.51	-0.17 - 1.17	3.57	7.18	-0.21 - 1.43
3.05 (120")	3.78	7.61	-0.23 - 1.52	3.89	7.82	-0.21 - 1.41	4.29	8.62	-0.26 - 1.72
3.81 (150")	4.74	9.53	-0.28 - 1.90	4.88	9.79	-0.26 - 1.76	5.38	10.79	-0.32 - 2.15
5.08 (200")	6.34	12.72	-0.38 - 2.53	6.52	13.07	-0.35 - 2.34	7.19	14.40	-0.43 - 2.87
6.35 (250")	7.94	15.91	-0.47 - 3.16	8.16	16.35	-0.44 - 2.93	9.00	18.01	-0.53 - 3.58
7.62 (300")	9.54	19.10	-0.57 - 3.80	9.81	19.63	-0.52 - 3.51	10.81	21.62	-0.64 - 4.30

Formula for calculating the projection distance

To use a projected image size not listed in this manual, check the projected image size SD (m) and use the respective formula to calculate the value.

The unit of all the formulae is m. (Values obtained by the following calculation formulae contain a slight error.)

When calculating the value using image size designation (value in inches), multiply the value in inches by 0.0254 and substitute it into SD in the formula.

	Aspect ratio 16:10	Aspect ratio 16:9	Aspect ratio 4:3
Projected image size Height (SH)	= SD x 0.530	= SD x 0.490	= SD x 0.6
Projected image size Width (SW)	= SD x 0.848	= SD x 0.872	= SD x 0.8
Minimum projection distance (LW)	= 1.2598 x SD - 0.0526	= 1.2949 x SD - 0.0526	= 1.4262 x SD - 0.0526
Maximum projection distance (LT)	= 2.5118 x SD - 0.0390	= 2.5816 x SD - 0.0390	= 2.8436 x SD - 0.0390

Adjusting adjustable feet

Install the projector on a flat surface so that the front of the projector is parallel to the screen surface and the projection screen is rectangular.

If the screen is tilted downward, extend the front adjustable feet so that the projected image becomes rectangular.

The adjustable feet can also be used to adjust the projector to be level when it is tilted in the horizontal direction.

Adjustable feet can be extended by turning them as shown in the figure. Turning them in the opposite direction will return them to the original position.

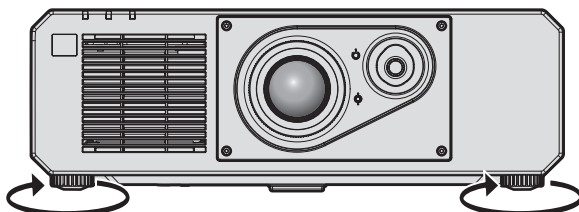

Maximum adjustable range

Adjustable feet: 35 mm (1-3/8") each

Attention

- Be careful not to block the intake/exhaust ports with your hands or any objects when adjusting the adjustable feet while the light source is on. (➔ page 26)

Connecting

Before connecting

- Before connecting, carefully read the operating instructions for the external device to be connected.
- Turn off the power of all devices before connecting cables.
- Take note of the following points before connecting the cables. Failure to do so may result in malfunctions.
 - When connecting a cable to a device connected to the projector or the projector itself, touch any nearby metallic objects to eliminate static electricity from your body before performing work.
 - Do not use unnecessarily long cables to connect a device to the projector or to the projector body. The longer the cable, the more susceptible to noise it becomes. Since using a cable while it is wound makes it act like an antenna, it is more susceptible to noise.
 - When connecting cables, connect GND first, then insert the connecting terminal of the connecting device in a straight manner.
- Acquire any connection cable necessary to connect the external device to the system that is neither supplied with the device nor available as an option.
- If video signals from video equipment contain too much jitter, the images on the screen may wobble. In this case, a time base corrector (TBC) must be connected.
- If synchronization signals output from computers or video equipment are disrupted due to changes in the video output setting or other reasons, colors of projected images may be temporarily disrupted.
- The projector accepts video signals, Y/C signals, YC_BC_R/YP_BP_R signals, analog RGB signals (synchronization signals are TTL level), and digital signals.
- Some computer models or graphics cards are not compatible with the projector.
- Use a cable compensator when you connect devices to the projector using long cables. Otherwise the projector may not project the image properly.
- For details of the types of video signals that can be used with the projector, refer to “List of compatible signals” (➔ page 167).

<COMPUTER 1 IN> terminal/<COMPUTER 2 IN/1 OUT> terminal pin assignments and signal names

Outside view	Pin No.	Signal name	Pin No.	Signal name
	(1)	R/P _R /C	(9)	+5 V
	(2)	G/Y/Y	(10)	GND
	(3)	B/P _B	(11)	GND
	(4)	—	(12)	DDC data
	(5)	GND	(13)	HD/SYNC
	(6)	GND	(14)	VD
	(7)	GND	(15)	DDC clock
	(8)	GND		

<HDMI 1 IN> terminal/<HDMI 2 IN> terminal pin assignments and signal names

Outside view	Pin No.	Signal name	Pin No.	Signal name
	(1)	T.M.D.S data 2+	(11)	T.M.D.S clock shield
	(2)	T.M.D.S data 2 shield	(12)	T.M.D.S clock-
	(3)	T.M.D.S data 2-	(13)	CEC
	(4)	T.M.D.S data 1+	(14)	—
	(5)	T.M.D.S data 1 shield	(15)	SCL
	(6)	T.M.D.S data 1-	(16)	SDA
	(7)	T.M.D.S data 0+	(17)	DDC/CEC GND
	(8)	T.M.D.S data 0 shield	(18)	+5 V
	(9)	T.M.D.S data 0-	(19)	Hot plug detection
	(10)	T.M.D.S clock+		

<DVI-D IN> terminal pin assignments and signal names

Outside view	Pin No.	Signal name	Pin No.	Signal name
	(1)	T.M.D.S data 2-	(13)	—
	(2)	T.M.D.S data 2+	(14)	+5 V
	(3)	T.M.D.S data 2/4 shield	(15)	GND
	(4)	—	(16)	Hot plug detection
	(5)	—	(17)	T.M.D.S data 0-
	(6)	DDC clock	(18)	T.M.D.S data 0+
	(7)	DDC data	(19)	T.M.D.S data 0/5 shield
	(8)	—	(20)	—
	(9)	T.M.D.S data 1-	(21)	—
	(10)	T.M.D.S data 1+	(22)	T.M.D.S clock shield
	(11)	T.M.D.S data 1/3 shield	(23)	T.M.D.S clock+
	(12)	—	(24)	T.M.D.S clock-

Connecting example: AV equipment

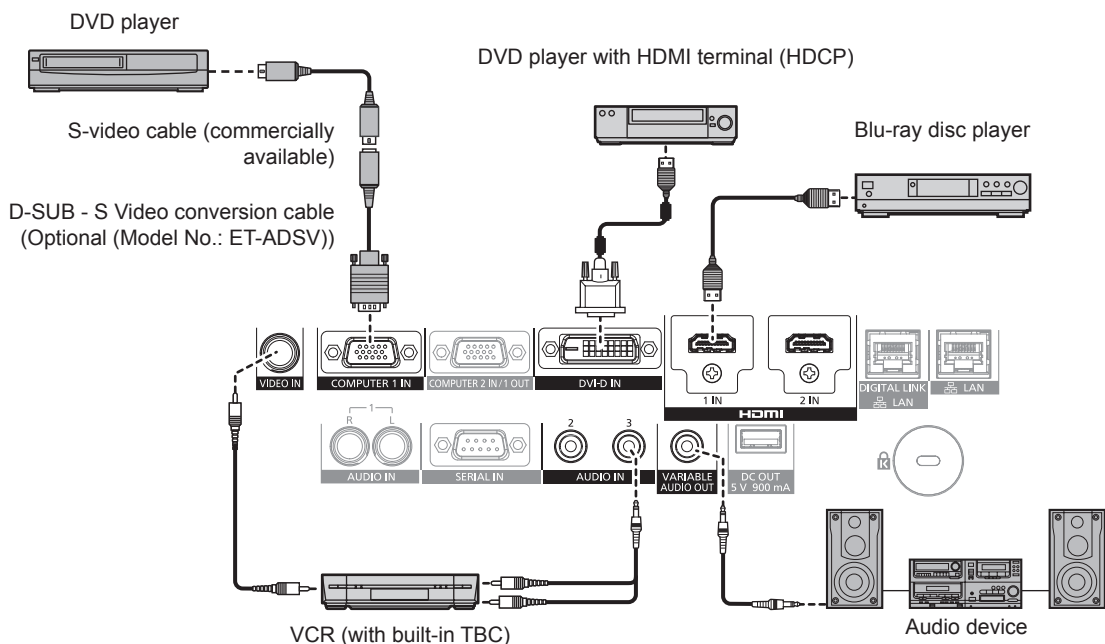

Attention

- Be sure to use one of the following when connecting a VCR.
 - Use a VCR with built-in time base corrector (TBC).
 - Use a time base corrector (TBC) between the projector and the VCR.
- The image may be disrupted when nonstandard burst signal is connected. In such a case, connect the time base corrector (TBC) between the projector and the external devices.

Note

- Switching of the setting in the [DISPLAY OPTION] menu → [DVI-D IN] → [EDID SELECT] may be required depending on the connected external device when DVI-D is input.
- The <DVI-D IN> terminal can be connected with the HDMI and DVI-D compatible devices. However, some external devices may not be able to project images properly, such as the image not displaying.
- For the HDMI cable, use an HDMI High Speed cable that conforms to the HDMI standards is used, images may be interrupted or may not be projected.
- The <HDMI 1 IN>/<HDMI 2 IN> terminals can be connected to an external device with the DVI-D terminal by using an HDMI/DVI conversion cable. However, this may not function properly for some external devices, and image may not be projected.
- The projector does not support VIERA Link (HDMI).
- When Y/C signal is input to the <COMPUTER 1 IN> terminal using the optional D-SUB - S Video conversion cable (Model No.: ET-ADSV), it is necessary to switch the setting with the [DISPLAY OPTION] menu → [COMPUTER IN/OUT] → [INPUT SETTING].
- When RGB signal or YC_BC_R/YP_BP_R signal input to the <COMPUTER 1 IN> terminal is output from the <COMPUTER 2 IN/1 OUT> terminal, it is necessary to switch the setting with the [DISPLAY OPTION] menu → [COMPUTER IN/OUT] → [COMPUTER2 SELECT].

Connecting example: Computers

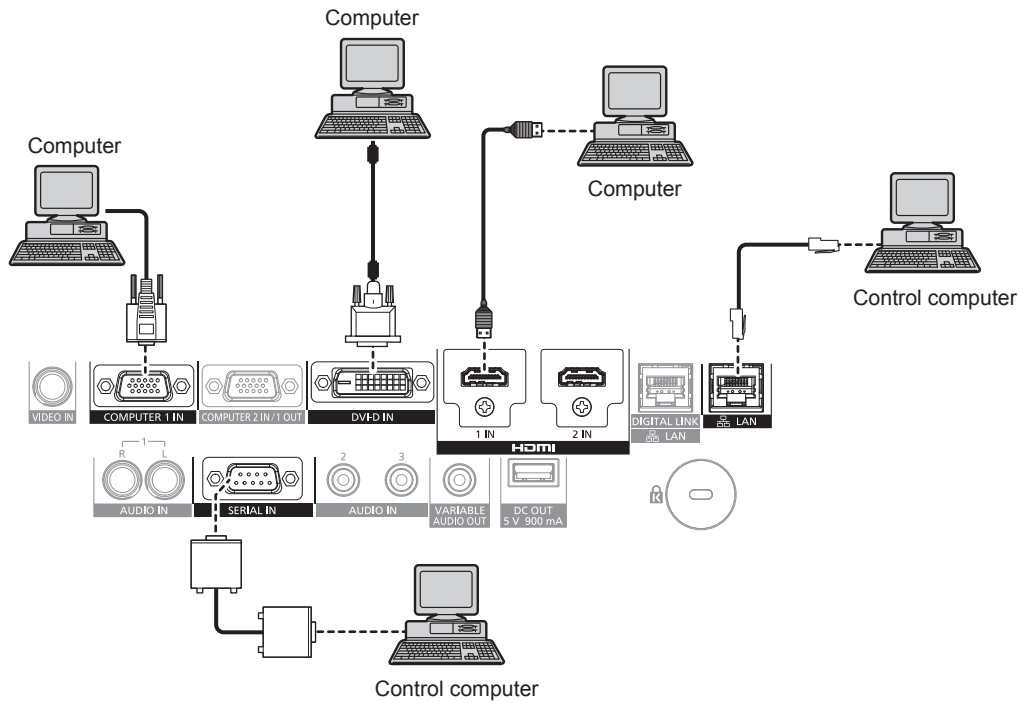

Attention

- When connecting the projector to a computer or an external device, use the power cord supplied with each device and commercially available shielded cables.

Note

- Switching of the setting in the [DISPLAY OPTION] menu → [DVI-D IN] → [EDID SELECT] may be required depending on the connected external device when DVI-D is input.
- For the HDMI cable, use an HDMI High Speed cable that conforms to the HDMI standards. If a cable that does not conform to the HDMI standards is used, images may be interrupted or may not be projected.
- The <HDMI 1 IN>/<HDMI 2 IN> terminals can be connected to an external device with the DVI-D terminal by using an HDMI/DVI conversion cable. However, this may not function properly for some external devices, and image may not be projected.
- The <DVI-D IN> terminal supports single links only.
- If you operate the projector using the computer with the resume feature (last memory), you may have to reset the resume feature to operate the projector.
- When RGB signal or $YCbCr/YPbPr$ signal input to the <COMPUTER 1 IN> terminal is output from the <COMPUTER 2 IN/1 OUT> terminal, it is necessary to switch the setting with the [DISPLAY OPTION] menu → [COMPUTER IN/OUT] → [COMPUTER2 SELECT].

Connecting example using DIGITAL LINK

Twisted-pair-cable transmitter based on the communication standard HDBaseT™ such as the optional DIGITAL LINK output supported device (Model No.: ET-YFB100G, ET-YFB200G) uses the twisted pair cable to transmit input images, audio, Ethernet, and serial control signal, and the projector can input such digital signal to the <DIGITAL LINK/LAN> terminal.

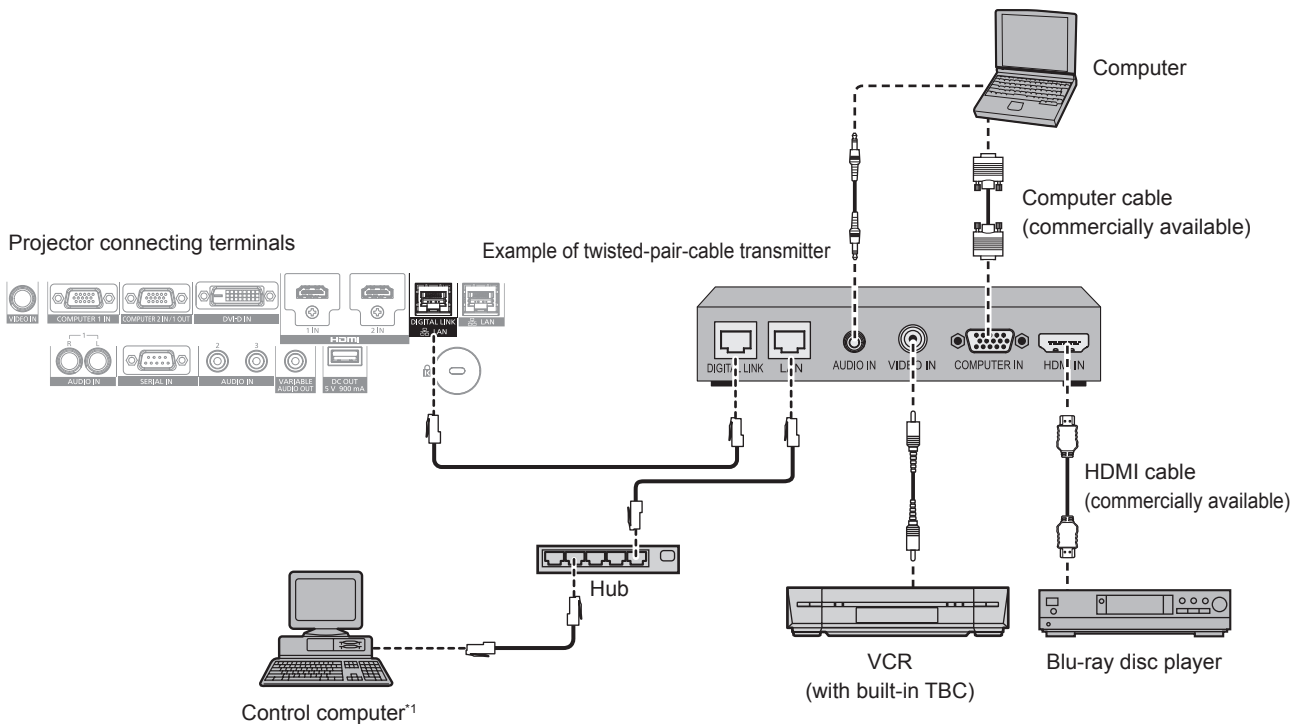

*1 Control target is the projector or the twisted-pair-cable transmitter. The control itself may not be possible depending on the twisted-pair-cable transmitter. Check the operating instructions of the device to be connected.

Attention

- Always use one of the following when connecting a VCR.
 - Use a VCR with built-in time base corrector (TBC).
 - Use a time base corrector (TBC) between the projector and the VCR.
- The image may be disrupted when nonstandard burst signal is connected. In such a case, connect the time base corrector (TBC) between the projector and the external devices.
- Ask a qualified technician or your dealer to install the cable wiring between the twisted-pair-cable transmitter and the projector. Image may be disrupted if cable transmission characteristics cannot be obtained due to inadequate installation.
- For the LAN cable between the twisted-pair-cable transmitter and the projector, use a cable that meets the following criteria:
 - Conforming to CAT5e or higher standards
 - Shielded type (including connectors)
 - Straight-through
 - Single wire
- When laying cables between the twisted-pair-cable transmitter and the projector, confirm that cable characteristics are compatible with CAT5e or higher using tools such as a cable tester or cable analyzer. When a relay connector is used, include it in the measurement.
- Do not use a hub between the twisted-pair-cable transmitter and the projector.
- When connecting to the projector using a twisted-pair-cable transmitter (receiver) of other manufacturers, do not place another twisted-pair-cable transmitter between the twisted-pair-cable transmitter of other manufacturers and the projector. This may cause image to be disrupted.
- Do not pull cables forcefully. Also, do not bend or fold cables unnecessarily.
- To reduce the effects of noise as much as possible, stretch out the cables between the twisted-pair-cable transmitter and the projector without any loops.
- Lay the cables between the twisted-pair-cable transmitter and the projector away from other cables, particularly power cables.
- When laying multiple cables, run them side by side along the shortest distance possible without bundling them together.
- After laying the cables, go to the [NETWORK] menu → [DIGITAL LINK STATUS] and confirm that the value of [SIGNAL QUALITY] is displayed in green which indicates normal quality. (▶ page 122)

Note

- For the HDMI cable, use an HDMI High Speed cable that conforms to the HDMI standards. If a cable that does not conform to the HDMI standards is used, images may be interrupted or may not be projected.
- The projector does not support VIERA Link (HDMI).
- The maximum transmission distance between the twisted-pair-cable transmitter and the projector is 100 m (328'1"). It is possible to transmit up to 150 m (492'2") if the twisted-pair-cable transmitter supports the long-reach communication method. If this distance is exceeded, image may be disrupted or a malfunction may occur in LAN communication. Please note that Panasonic does not support the use of the projector outside the maximum transmission distance. When connecting with the long reach, video signal or distance that can be transmitted may be restricted, depending on the specification of the twisted-pair-cable transmitter.

- For twisted-pair-cable transmitters of other manufacturers of which the operation has been verified with the projector, visit the Panasonic website (<http://panasonic.net/avc/projector/>). Note that the verification for devices of other manufacturers has been made for the items set by Panasonic Corporation, and not all the operations have been verified. For operation or performance problems caused by the devices of other manufacturers, contact the respective manufacturers.

Chapter 3 Basic Operations

This chapter describes basic operations to start with.

Switching on/off the projector

Connecting the power cord

Make sure that the supplied power cord is securely fixed to the projector body to prevent it from being removed easily.

Confirm that the <MAIN POWER> switch is on the <OFF> side before connecting the power cord.

Use the power cord matching with the power supply voltage and the shape of the outlet.

For details of power cord handling, refer to “Read this first!” (➔ page 5).

How to attach the power cord

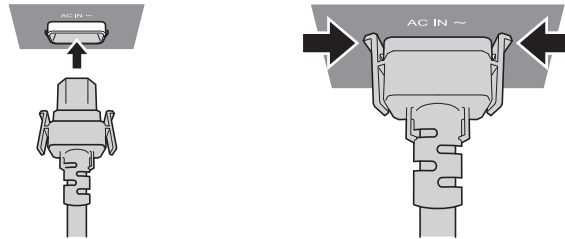

- 1) Check the shapes of the <AC IN> terminal on the side of the projector and the power cord connector, and insert the connector completely in the correct direction (until you hear the side tabs click in place).

How to remove the power cord

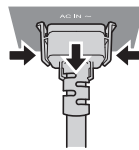

- 1) Confirm that the <MAIN POWER> switch on the side of the projector is on the <OFF> side, and remove the power plug from the outlet.
- 2) Remove the power cord connector from the <AC IN> terminal of the projector while pressing the side tabs.

Power indicator

Indicate the status of the power. Check the status of the power indicator <ON (G)/STANDBY (R)> before operating the projector.

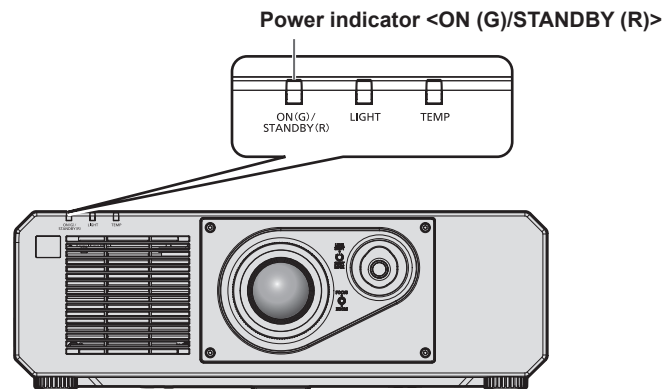

Indicator status	Projector status
Off	The main power is switched off.

Indicator status		Projector status
Red	Lit	<p>The power is switched off. (standby mode) Projection will start when the power <P/I> button is pressed.</p> <ul style="list-style-type: none"> The setting of the projector is as follows. <ul style="list-style-type: none"> The [PROJECTOR SETUP] menu → [ECO MANAGEMENT] → [QUICK STARTUP] is set to [OFF] The [PROJECTOR SETUP] menu → [AUDIO SETTING] → [IN STANDBY MODE] is set to [OFF] The projector may not operate when the light source indicator <LIGHT> or the temperature indicator <TEMP> is blinking. (➔ page 148)
	Blinking	<p>The power is switched off. (standby mode) Projection will start when the power <P/I> button is pressed.</p> <ul style="list-style-type: none"> The projector is set to one of the following. Power consumption is high. <ul style="list-style-type: none"> The [PROJECTOR SETUP] menu → [ECO MANAGEMENT] → [QUICK STARTUP] is set to [ON] The [PROJECTOR SETUP] menu → [AUDIO SETTING] → [IN STANDBY MODE] is set to [ON] The indicator will change to a red light when the specified time has elapsed after the projector enters the standby mode if the projector is set as following. The specified time is a time set in the [PROJECTOR SETUP] menu → [ECO MANAGEMENT] → [QUICK STARTUP] → [VALID PERIOD]. <ul style="list-style-type: none"> The [PROJECTOR SETUP] menu → [ECO MANAGEMENT] → [QUICK STARTUP] is set to [ON] The [PROJECTOR SETUP] menu → [AUDIO SETTING] → [IN STANDBY MODE] is set to [OFF] The projector may not operate when the light source indicator <LIGHT> or the temperature indicator <TEMP> is blinking. (➔ page 148)
Green	Lit	Projecting.
Orange	Lit	The projector is preparing to switch off the projector. The power is switched off after a while. (Changes to the standby mode.)

Note

- While the power indicator <ON (G)/STANDBY (R)> lights in orange, the fan is running to cool the projector.
- For approximately five seconds after the projector is turned off, the indicator does not light up even if the power is turned on. Turn on the power again after the power indicator <ON (G)/STANDBY (R)> lights/blinks in red.
- The projector consumes power even in standby mode (power indicator <ON (G)/STANDBY (R)> lights/blinks in red). Refer to “Power consumption” (➔ page 170) for the power consumption.
- The power indicator <ON (G)/STANDBY (R)> will blink if the projector receives a remote control signal.
- The power indicator <ON (G)/STANDBY (R)> will blink slowly in green while the shutter function is in use (shutter: closed), or while the function of the [PROJECTOR SETUP] menu → [ECO MANAGEMENT] → [AUTO POWER SAVE] → [NO SIGNAL LIGHTS-OUT] is operating and the light source is turned off.

Switching on the projector

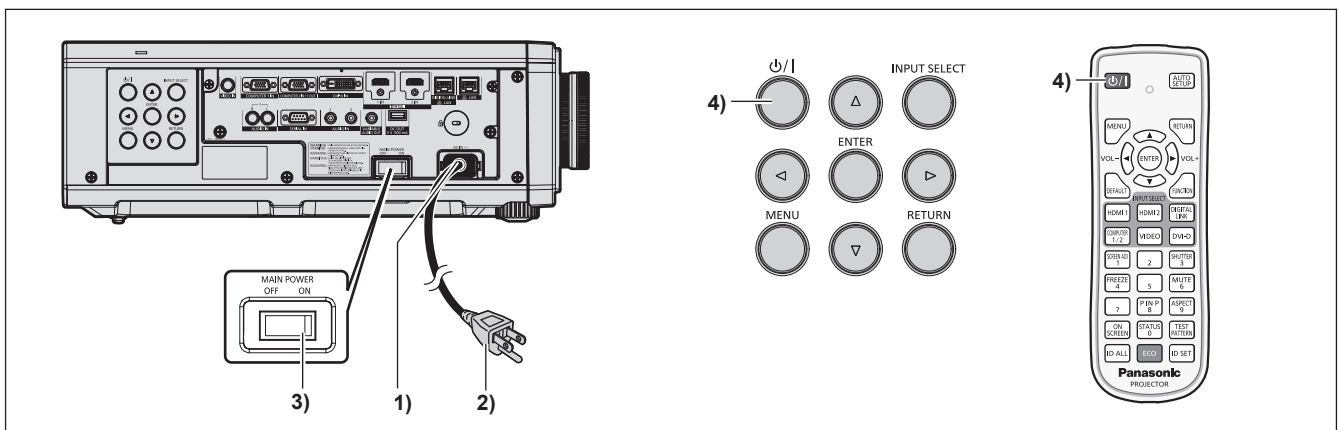

- 1) Connect the power cord to the projector.
- 2) Connect the power plug to an outlet.
- 3) Press the <ON> side of the <MAIN POWER> switch to turn on the power.
 - The power indicator <ON (G)/STANDBY (R)> lights/blinks in red, and the projector enters the standby mode.

4) Press the power <⏻/|> button.

- The power indicator <ON (G)/STANDBY (R)> lights in green and the image is soon projected on the screen.

Note

- A warm-up period of up to approximately five minutes may be necessary until an image is displayed when the projector is switched on at around 0 °C (32 °F).
The temperature indicator <TEMP> lights in red during the warm-up period. When the warm-up is completed, the temperature indicator <TEMP> turns off and the projection starts. Refer to “When an indicator lights up” (➔ page 148) for the indicator status display.
- If the operating environment temperature is low and warm-up takes more than five minutes, the projector will judge that a problem has occurred and the power will automatically be set to standby mode. In such case, increase the operating environment temperature to 0 °C (32 °F) or higher, turn off the main power, and then turn on the power again.
- When the [PROJECTOR SETUP] menu → [ECO MANAGEMENT] → [STANDBY MODE] is set to [ECO], it takes longer for the projection to start after the power is turned on, compared to when set to [NORMAL].
- When the [PROJECTOR SETUP] menu → [ECO MANAGEMENT] → [QUICK STARTUP] is set to [ON], and the power is turned on before the specified time elapses after the projector enters the standby mode, an image will be projected approximately one second after the power is turned on.
The specified time is a time set in the [PROJECTOR SETUP] menu → [ECO MANAGEMENT] → [QUICK STARTUP] → [VALID PERIOD].
- When the power is turned on or an input signal is switched, you may here a high-frequency driving sound. This is not a malfunction.
- If the power was turned off at the previous use by pressing the <OFF> side of the <MAIN POWER> switch or by using the breaker directly while projecting, the power indicator <ON (G)/STANDBY (R)> lights up in green and an image is projected after a while when the power is turned on by pressing the <ON> side of the <MAIN POWER> switch or by turning the breaker on with the power plug connected to the outlet. This applies only when the [PROJECTOR SETUP] menu → [INITIAL STARTUP] is set to [LAST MEMORY].

When the initial setting screen is displayed

When the projector is switched on for the first time after purchase, as well as when the [PROJECTOR SETUP] menu → [INITIALIZE] → [ALL USER DATA] is executed, the [INITIAL SETTING] screen is displayed after projection starts. Set them according to the circumstances.

In other occasions, you can change the settings by menu operations.

If you press the <MENU> button while the [INITIAL SETTING] screen is displayed, you can go back to the previous screen.

Same operation is available by pressing the <RETURN> button.

Note

- It may be necessary to adjust with the focus ring and the zoom ring on the lens section of the projector to clearly display the menu screen when using the projector for the first time.
Refer to “Adjusting the image” (➔ page 48) for details.

Initial setting (display language)

Select the language to show on the screen.

After completed the initial setting, you can change the display language from the [DISPLAY LANGUAGE] menu.

1) Press ▲▼◀▶ to select the display language.

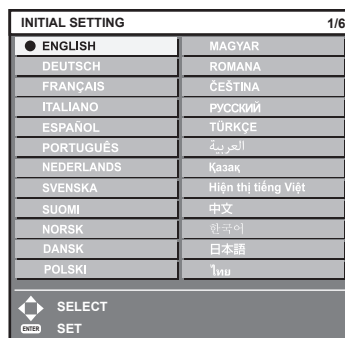

2) Press the <ENTER> button to proceed to the initial setting.

Initial setting (installation setting)

Set [FRONT/REAR] and [FLOOR/CEILING] in [PROJECTION METHOD] depending on the installation mode. Refer to “Installation mode” (➔ page 30) for details.

After completed the initial setting, you can change the setting from the [PROJECTOR SETUP] menu → [PROJECTION METHOD].

1) Press ◀▶ to switch the setting.

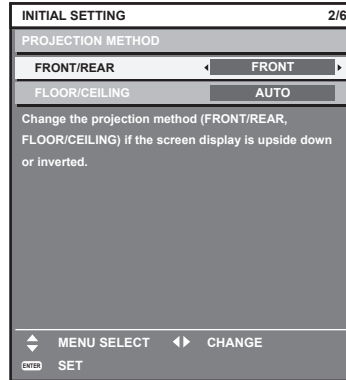

2) Press the <ENTER> button to proceed to the initial setting.

Initial setting (standby mode)

Set the operation mode during standby. The factory default setting is [NORMAL], which allows you to use the network function during standby. To keep power consumption low during standby, set this item to [ECO].

After completed the initial setting, you can change the setting from the [PROJECTOR SETUP] menu → [ECO MANAGEMENT] → [STANDBY MODE].

1) Press ◀▶ to switch the setting.

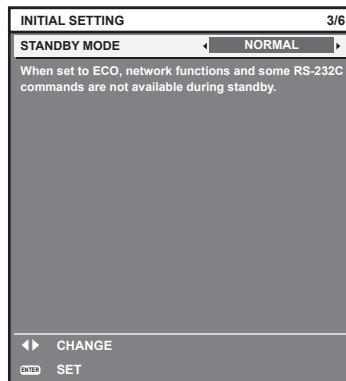

2) Press the <ENTER> button to proceed to the initial setting.

Note

- The preceding initial setting screen is displayed when the projector is switched on for the first time after purchase. When the [PROJECTOR SETUP] menu → [INITIALIZE] → [ALL USER DATA] is executed, the [STANDBY MODE] setting before executing is displayed.

Initial setting (screen setting)

Set the screen format (aspect ratio) and display position of the image.

After completed the initial setting, you can change the settings of each item from the [DISPLAY OPTION] menu → [SCREEN SETTING].

1) Press ◀▶ to switch the setting.

- Proceed to Step 4) when [16:10] is selected.

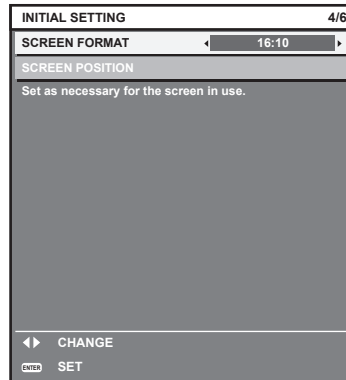

2) Press ▲▼ to select [SCREEN POSITION].

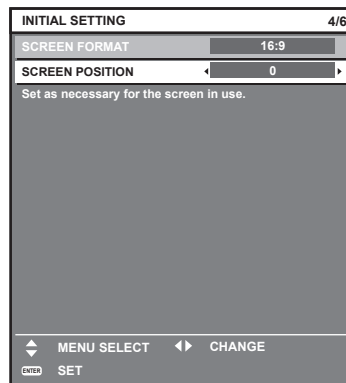

3) Press ◀▶ to adjust.

4) Press the <ENTER> button to proceed to the initial setting.

Initial setting (time zone)

Set [TIME ZONE] in accordance with the country or region where you use the projector.

After completed the initial setting, you can change the setting from the [PROJECTOR SETUP] menu → [DATE AND TIME]. The current settings are displayed in [LOCAL DATE] and [LOCAL TIME].

1) Press ◀▶ to switch the setting.

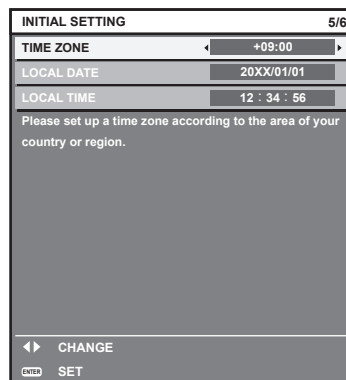

2) Press the <ENTER> button to proceed to the initial setting.

Note

- In the factory default setting, the time zone of the projector is set to +09:00 (Japan and Korea Standard Time). Change the setting of the [PROJECTOR SETUP] menu → [DATE AND TIME] → [TIME ZONE] to the time zone of the region where you use the projector.

Initial setting (date and time)

Set the local date and time. After completed the initial setting, you can change the setting from the [PROJECTOR SETUP] menu → [DATE AND TIME].

To set the date and time automatically, refer to “Setting the date and time automatically” (➡ page 110).

1) Press ▲▼ to select an item.

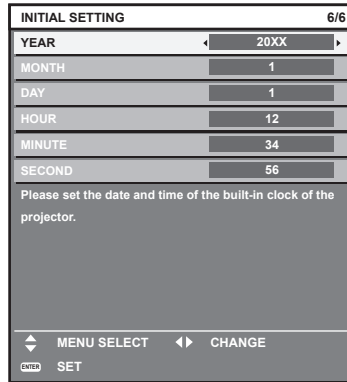

2) Press ◀▶ to switch the setting.

3) Press the <ENTER> button.

- Confirm the setting value and complete the initial setting.

Making adjustments and selections

It is recommended that images be projected continuously for at least 30 minutes before the focus is adjusted.

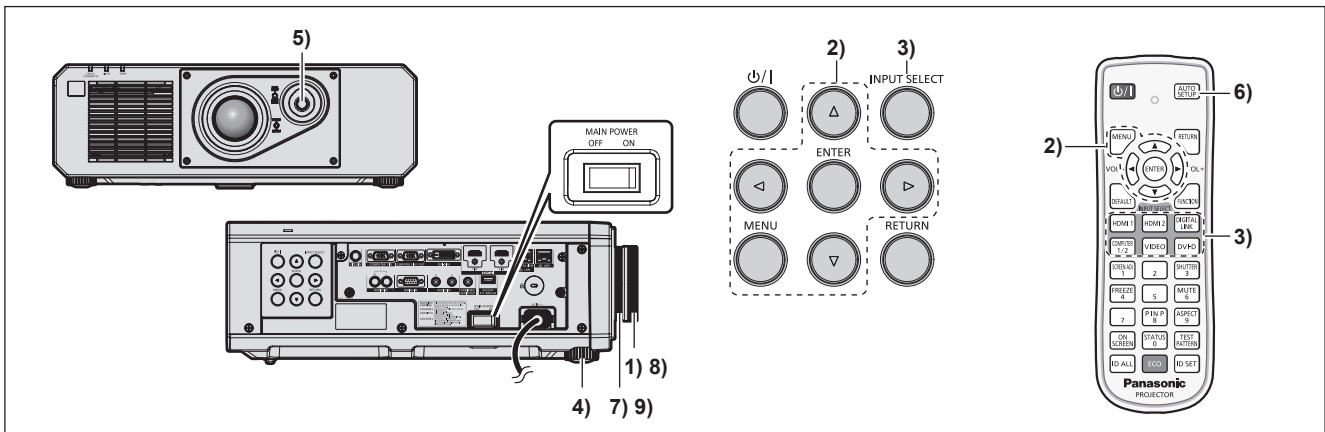

1) Turn the focus ring to roughly adjust the focus of the projected image. (➡ page 48)

2) Change the setting of the [PROJECTOR SETUP] menu → [PROJECTION METHOD] depending on the installation mode. (➡ page 30)

- Refer to “Navigating through the menu” (➡ page 57) for the operation of the menu screen.

3) Select the input by pressing the input selection button on the remote control or the control panel.

- The buttons that can be used on the remote control or the control panel are as follows.

Remote control:

<HDMI 1> button, <HDMI 2> button, <DIGITAL LINK> button, <COMPUTER 1/2> button, <VIDEO> button, <DVI-D> button

Control panel:

<INPUT SELECT> button

- For details of operation for input selection, refer to “Selecting the input signal” (➡ page 47).

4) Adjust the front, back and sideway tilt of the projector with the adjustable feet. (➡ page 33)

- 5) Adjust the position of the projected image by operating the lens shift lever.
- 6) If the input signal is the analog RGB signal or the DVI-D/HDMI signal, press the <AUTO SETUP> button.
- 7) Turn the zoom ring to adjust the size of the projected image to match the screen.
- 8) Adjust the focus again with the focus ring.
- 9) Adjust the zoom again with the zoom ring to adjust the size of the projected image to match the screen.

Note

- When the projector is switched on for the first time after purchase, as well as when the [PROJECTOR SETUP] menu → [INITIALIZE] → [ALL USER DATA] is executed, the [INITIAL SETTING] screen is displayed after projection starts. Refer to “When the initial setting screen is displayed” (➔ page 42) for details.

Switching off the projector

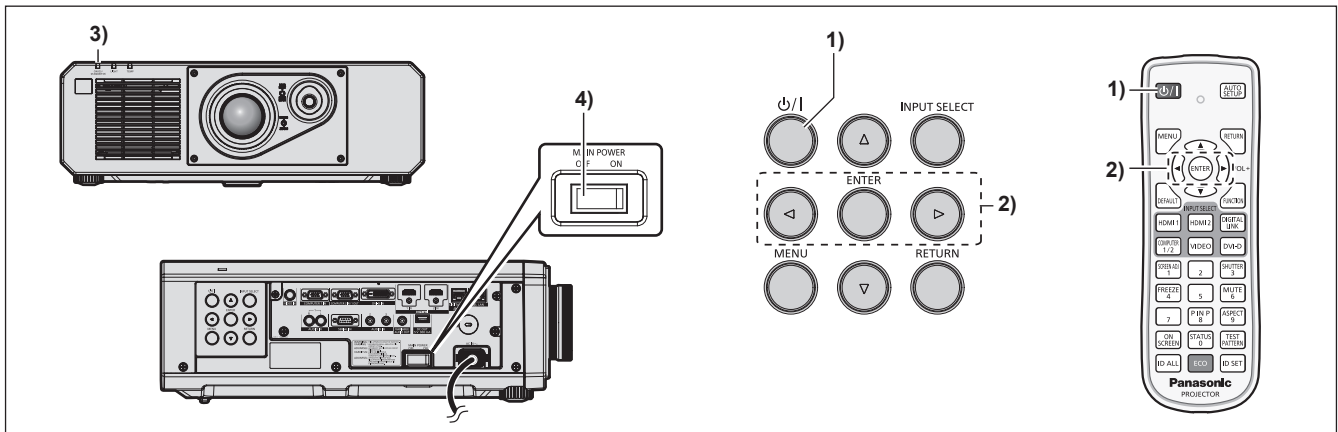

- 1) Press the power <⏻/⏹> button.
 - The [POWER OFF(STANDBY)] confirmation screen is displayed.
- 2) Press <◀▶> to select [OK], and press the <ENTER> button.
(Or press the power <⏻/⏹> button again.)
 - Projection of the image will stop, and the power indicator <ON (G)/STANDBY (R)> on the projector body lights in orange. (The fan keeps running.)
- 3) Wait for a few seconds until the power indicator <ON (G)/STANDBY (R)> of the projector body lights/blinks in red.
- 4) Press the <OFF> side of the <MAIN POWER> switch to turn off the power.

Note

- For approximately five seconds after the projector is turned off, the indicator does not light up even if the power is turned on.
- Even when the power <⏻/⏹> button is pressed and the projector is switched off, the projector consumes power if the main power of the projector is on.
When the [PROJECTOR SETUP] menu → [ECO MANAGEMENT] → [STANDBY MODE] is set to [ECO], use of some functions is restricted, but the power consumption during standby mode can be conserved.
- While projecting, the power can be turned off by pressing the <OFF> side of the <MAIN POWER> switch, or by directly using the breaker under conditions where the <MAIN POWER> switch of the projector cannot be switched off/on easily such as while installing on the ceiling. However, the settings or adjustments performed right before the power is turned off may not be reflected.

Projecting

Check the external device connection (➔ page 34) and the power cord connection (➔ page 40), and turn on the power (➔ page 41) to start projection. Select the image to project, and adjust appearance of the projected image.

Selecting the input signal

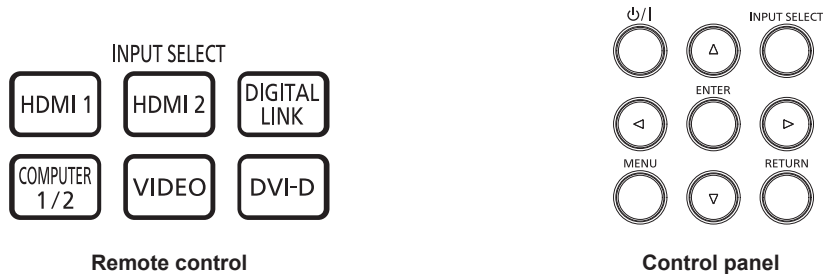

The input of the image to project can be switched. Method to switch the input is as follows.

- Press the input selection button on the remote control and directly specify the input to project.
- Press the <INPUT SELECT> button on the control panel to display the input selection screen, and select the input to project from the list.

Switching the input directly with the remote control

The input for projection can be switched by directly specifying it with the input selection button on the remote control.

- 1) Press the input selection button (<HDMI 1>, <HDMI 2>, <DIGITAL LINK>, <COMPUTER 1/2>, <VIDEO>, <DVI-D>).

<HDMI 1>	Switches the input to HDMI1. The image of the signal input to the <HDMI 1 IN> terminal is projected.
<HDMI 2>	Switches the input to HDMI2. The image of the signal input to the <HDMI 2 IN> terminal is projected.
<DIGITAL LINK>	Switches the input to DIGITAL LINK. The image of the signal input to the <DIGITAL LINK/LAN> terminal is projected.
<COMPUTER 1/2>	Switches the input to COMPUTER1 or COMPUTER2. Switches to the other input when one input has already been selected. The image of the signal input to the <COMPUTER 1 IN> terminal or the <COMPUTER 2 IN/1 OUT> terminal is projected.
<VIDEO>	Switches the input to VIDEO. The image of the signal input to the <VIDEO IN> terminal is projected.
<DVI-D>	Switches the input to DVI-D. The image of the signal input to the <DVI-D IN> terminal is projected.

Attention

- Images may not be projected properly depending on the external device, or the Blu-ray disc or DVD disc, to be played back.
Set the [PICTURE] menu → [SYSTEM SELECTOR].
- Confirm the aspect ratio of the projection screen and the image, and switch to an optimum aspect ratio from the [POSITION] menu → [ASPECT].

Note

- When the optional DIGITAL LINK output supported device (Model No.: ET-YFB100G, ET-YFB200G) is connected to the <DIGITAL LINK/LAN> terminal, the input on the DIGITAL LINK output supported device changes each time the <DIGITAL LINK> button is pressed. The input can also be changed using the RS-232C control command.
For twisted-pair-cable transmitters of other manufacturers, switch the input on the projector to DIGITAL LINK, and then switch the input on the twisted-pair-cable transmitter.
- Set the [DISPLAY OPTION] menu → [COMPUTER IN/OUT] → [INPUT SETTING] in accordance with the signal input to the <COMPUTER 1 IN> terminal.
- Set the [DISPLAY OPTION] menu → [COMPUTER IN/OUT] → [COMPUTER2 SELECT] to [COMPUTER2 IN] when a signal is to be input to the <COMPUTER 2 IN/1 OUT> terminal.

Switching the input by displaying the input selection screen

The input for projection can be selected by displaying the input selection screen using the <INPUT SELECT> button on the control panel.

1) Press the <INPUT SELECT> button on the control panel.

- The input selection screen is displayed.

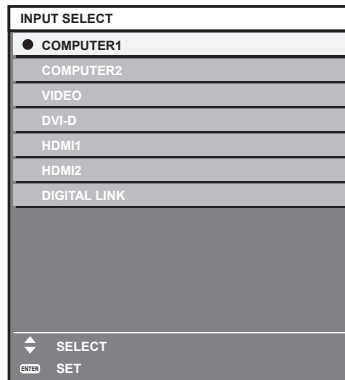

2) Press ▲▼ to select the input for projection, and press the <ENTER> button.

Note

- The input can also be switched by pressing the <INPUT SELECT> button while the input selection screen is displayed. The input will switch each time you press the <INPUT SELECT> button.
- If the optional DIGITAL LINK output supported device (Model No.: ET-YFB100G, ET-YFB200G) is connected to the projector, the input selection menu for the DIGITAL LINK output supported device is displayed when the <ENTER> button is pressed while the DIGITAL LINK input is selected in the input selection screen.
- If the optional DIGITAL LINK output supported device (Model No.: ET-YFB100G, ET-YFB200G) is connected to the projector, the DIGITAL LINK logo and the input name selected in the DIGITAL LINK output supported device are displayed in the display section of the [DIGITAL LINK] in the input selection screen.

Adjusting the image

Adjust the position, size, and focus of the projected image.

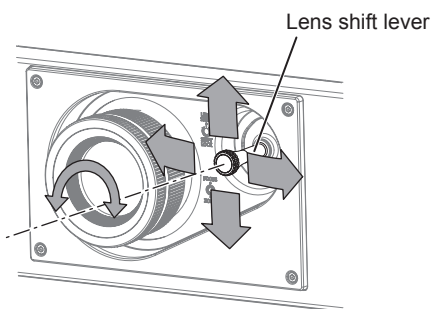

Fig. 1

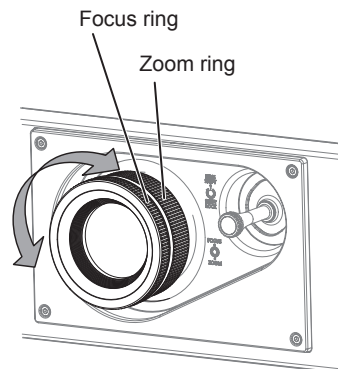

Fig. 2

1) Adjust the projection angle.

- Install the projector on a flat surface so that the front of the projector is parallel to the screen surface, making the projected image rectangular.
- If the projector is tilted downward than the screen, extend the adjustable feet so that the projected image becomes rectangular.
- Refer to “Adjusting adjustable feet” (➡ page 33) for details.

2) Turn the lens shift lever counterclockwise and release the fixing of the lens shift lever.

3) Adjust the lens shift. (Fig. 1)

- Adjust the position of the projected image by operating the lens shift lever.
- Refer to “Adjustment range by the lens position shift (optical shift)” (➡ page 49) for details.

4) Turn the lens shift lever clockwise to fix.

5) Adjust the zoom and the focus. (Fig. 2)

- Adjust the size of the projected image by turning the zoom ring.
- Adjust the focus by turning the focus ring.

Note

- It is recommended that images be projected continuously for at least 30 minutes before the focus is adjusted.
- Since the projected image size will change when the focus ring is turned, fine adjust the projected image size again by turning the zoom ring.
- Perform the [POSITION] menu → [SCREEN ADJUSTMENT] when the projected image is distorted.

Adjustment range by the lens position shift (optical shift)

Based on the standard projection position using the optical axis shift function, the projection position can be adjusted in the range shown in the following figure.

Following figure shows the adjustment range when the projector is installed on the floor.

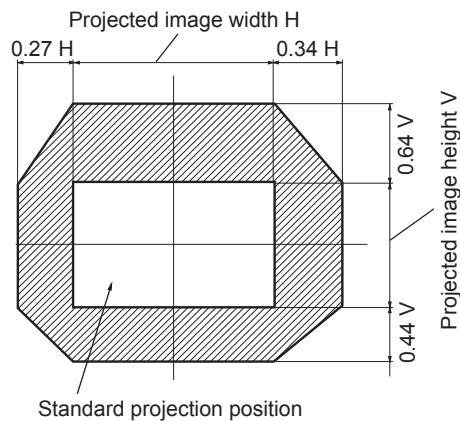

Note

- Optimal image can be achieved by installing the projector squarely in front of the screen and adjusting the lens shift lever to center.

Operating with the remote control

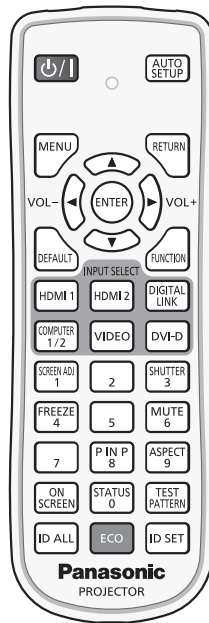

Using the shutter function

If the projector is not used for a certain period of time during the meeting intermission, for example, it is possible to turn off the image and audio temporarily.

SHUTTER 3 button

- 1) **Press the <SHUTTER> button.**
 - The image and audio disappear.
- 2) **Press the <SHUTTER> button again.**
 - The image and audio reappear.

Note

- The power indicator <ON (G)/STANDBY (R)> will blink slowly in green while the shutter function is in use (shutter: closed).
- The fade-in/fade-out time of the image can be set by the [DISPLAY OPTION] menu → [SHUTTER SETTING].
- To output audio while the shutter function is in use (shutter: closed), set the [PROJECTOR SETUP] menu → [AUDIO SETTING] (➔ page 107) → [IN SHUTTER] to [ON].
- The projector does not have a built-in speaker. Audio is output from the external audio system connected to the <VARIABLE AUDIO OUT> terminal.
- The light source may be lit dimly due to warm up when the shutter function is used in the operating environment temperature of around 0 °C (32 °F).

Using the mute function

Audio can be temporarily turned off.

MUTE 6 button

- 1) **Press the <MUTE> button.**
 - The audio is muted.
- 2) **Press the <MUTE> button again.**
 - The audio is turned on.

Adjusting the volume

Adjust the volume of audio output.



- 1) Press the <VOL-> button/<VOL+> button on the remote control.

<VOL+>	Increases the volume.
<VOL->	Decreases the volume.

Note

- This operation can be also performed using ◀▶ on the control panel.

Using the freeze function

The projected image can be paused and audio can be turned off regardless of the playback of the external device.



- 1) Press the <FREEZE> button.
 - The image freezes and audio is muted.
- 2) Press the <FREEZE> button again.
 - Freezing of the image is canceled and audio is turned on.

Note

- [FREEZE] is displayed on the screen when video is paused.
- When freezing of the moving image is canceled, the image may disappear or be disrupted temporarily.

Using the on-screen display function

Turn off the on-screen display function (no display) when you do not wish the viewers to see the on-screen display, such as the menu or the input terminal name.



- 1) Press the <ON SCREEN> button.
 - The on-screen display disappears.
- 2) Press the <ON SCREEN> button again.
 - The on-screen display appears.

Note

- If you press the <MENU> button on the control panel for at least three seconds while the on-screen display is off (hidden), the on-screen display is turned on.

Using the automatic setup function

The image position when the DVI-D/HDMI signal is input, or the resolution, clock phase, and image position when the analog RGB signal is input can be adjusted automatically. (Analog RGB signal is a signal structured with dots just like the computer signal.)

It is recommended to input an image with bright white borders at the edges and high-contrast black and white characters when the automatic adjustment is being performed.

Avoid using images that include halftones or gradation, such as photographs and computer graphics.



1) Press the <AUTO SETUP> button.

- [COMPLETE] is displayed when it has completed without any problem.

Note

- The clock phase may shift even if it has completed without any incident. In such a case, adjust the [POSITION] menu → [CLOCK PHASE] (➡ page 70).
- If an image with blurred edges or a dark image is input, [INCOMPLETE] may appear or adjustment may not be performed properly even when [COMPLETE] appears. In such a case, adjust the following settings.
 - [ADVANCED MENU] menu → [INPUT RESOLUTION] (➡ page 74)
 - [POSITION] menu → [CLOCK PHASE] (➡ page 70)
 - [POSITION] menu → [SHIFT] (➡ page 68)
- Adjust special signals according to the [DISPLAY OPTION] menu → [AUTO SETUP] (➡ page 81).
- Automatic adjustment may not be possible depending on the computer model.
- Automatic adjustment may not be possible for the synchronization signal for composite sync or SYNC ON GREEN.
- Image may be disrupted for a few seconds during automatic adjustment, but this is not a malfunction.
- Adjustment is required for each input signal.
- Automatic adjustment can be canceled by pressing the <MENU> button during the automatic adjustment operation.
- Even if a signal possible to perform the automatic setup is being input, it may not be able to adjust correctly if the automatic setup function is used while the moving image is being input. [INCOMPLETE] may be displayed, or the adjustment may not be completed correctly even if [COMPLETE] is displayed.

Using the screen adjustment function

The [SCREEN ADJUSTMENT] menu can be displayed.

Correct the distortion of the image that occurs when the projector is installed tilted or when the screen is tilted or curved.



1) Press the <SCREEN ADJ> button.

- The [SCREEN ADJUSTMENT] screen is displayed.

2) Press ◀▶ to switch the item.

- The items will switch each time you press the button.

[OFF]	Disables the screen adjustment function.
[KEystone]	Adjusts any trapezoidal distortion in the projected image.
[CORNER CORRECTION]	Adjusts any distortion in the four corners of the projected image.
[CURVED CORRECTION]	Adjusts any curved distortion in the projected image.

- The items will also switch by pressing the <SCREEN ADJ> button.
- Proceed to Step 3) when anything other than [OFF] is selected.

3) Press the <ENTER> button.

- The [KEystone] screen, the [CORNER CORRECTION] screen, or the [CURVED CORRECTION] screen is displayed.

Note

- To adjust [KEystone] or [CURVED CORRECTION], press ▲▼ to select the item to adjust, and press ◀▶ to adjust the item.
- To adjust [CORNER CORRECTION], press ▲▼ to select the item to adjust. Individual adjustment screen is displayed by pressing the <ENTER> button. Adjust the item using ▲▼◀▶.
- Only one of the [KEystone], [CORNER CORRECTION], or [CURVED CORRECTION] setting is enabled.

- Refer to the [POSITION] menu → [SCREEN ADJUSTMENT] (➔ page 70) for details.

Switching the image aspect ratio

Switch the image aspect ratio according to the input.



button

1) Press the <ASPECT> button.

- The setting will change each time you press the button.

Note

- Refer to the [POSITION] menu → [ASPECT] (➔ page 68) for details.

Using the P IN P function

Locate a separate, small sub screen in the main screen to project two images simultaneously.



button

1) Press the <P IN P> button.

- The setting will change each time you press the button.

Note

- Refer to "[P IN P] menu" (➔ page 112) for details.

Using the function button

By assigning the following functions to the <FUNCTION> button, it can be used as a simplified shortcut button. [SUB MEMORY], [SYSTEM SELECTOR], [DAYLIGHT VIEW], [WAVEFORM MONITOR]



button

1) Press the <FUNCTION> button.

Note

- Assignment of the function is performed from the [PROJECTOR SETUP] menu → [FUNCTION BUTTON] (➔ page 106).

Displaying internal test pattern

The projector has eight types of internal test patterns to check the condition of the projector body. To display test patterns, perform the following steps.



button

1) Press the <TEST PATTERN> button.

2) Press ◀▶ to select the test pattern.

Note

- Test patterns can also be displayed using the menu operation. Refer to "[TEST PATTERN] menu" (➔ page 114) for details.
- Settings of position, size, and other factors will not be reflected in test patterns. Make sure to display the input signal before performing various adjustments.

Using the status function

Display the status of the projector.



1) Press the <STATUS> button.

- The [STATUS] screen is displayed.

STATUS		1/3
PROJECTOR TYPE	RZ570(123456789012)	
PROJECTOR RUNTIME	10000h	
LIGHT RUNTIME	10000h / 10000h	
MAIN/SUB VERSION	1.00 / 1.00	
INTAKE AIR TEMP.	31°C/87°F	— I —
OPTICS MODULE TEMP.	27°C/80°F	— I —
EXHAUST AIR TEMP.	31°C/87°F	— I —
LIGHT TEMP. 1	31°C/87°F	— I —
LIGHT TEMP. 2	31°C/87°F	— I —
COOLING CONDITION	AUTO - FLOOR	
ATMOSPHERIC PRESSURE	1013hPa	
SELF TEST	NO ERRORS	
SEND E-MAIL	SEND E-MAIL	
CHANGE	EXIT	EXIT

Note

- The projector status can also be displayed using the menu operation. Refer to the [PROJECTOR SETUP] menu → [STATUS] (➔ page 108) for details.

Using the ECO management function

Display the setting screen relating to ECO management.



1) Press the <ECO> button.

Note

- Refer to the [PROJECTOR SETUP] menu → [ECO MANAGEMENT] (➔ page 96) for details.

Setting ID number of the remote control

When you use the multiple projectors together, you can operate all the projectors simultaneously or each projector individually using a single remote control, if a unique ID number is assigned to each projector.

After setting the ID number of the projector, set same ID number on the remote control.

The factory default ID number of the projector is set to [ALL]. When using a single projector, press the <ID ALL> button on the remote control. Also, you can control a projector by pressing the <ID ALL> button on the remote control even if you do not know the projector ID.



1) Press the <ID SET> button on the remote control.

2) Within five seconds, press and set the one-digit or two-digit ID number set on the projector body using the number (<0> - <9>) buttons.

- If you press the <ID ALL> button, you can control the projectors regardless of the ID number setting of the projector body.

Attention

- Since the ID number of the remote control can be set without the projector body, do not press the <ID SET> button on the remote control carelessly. If the <ID SET> button is pressed and no number (<0> - <9>) buttons are pressed within five seconds, the ID number returns to its original value before the <ID SET> button was pressed.

- The ID number set on the remote control will be stored unless it is set again. However, it will be erased if the remote control is left with dead batteries. Set the same ID number again when the batteries are replaced.

Note

- When the ID number of the remote control is set to [0], you can control the projector regardless of the ID number setting of the projector body, as same as when [ALL] is set.
- Set the ID number of the projector body from the [PROJECTOR SETUP] menu → [PROJECTOR ID].

Chapter 4 Settings

This chapter describes the settings and adjustments you can make using the on-screen menu.

Menu navigation

The on-screen menu (Menu) is used to perform various settings and adjustments of the projector.

Navigating through the menu

Operating procedure



- 1) Press the <MENU> button on the remote control or control panel.
 - The [MAIN MENU] screen is displayed.

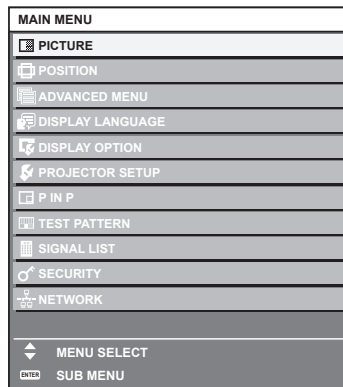

- 2) Press ▲▼ to select an item from the main menu.
 - The selected item is highlighted in yellow.

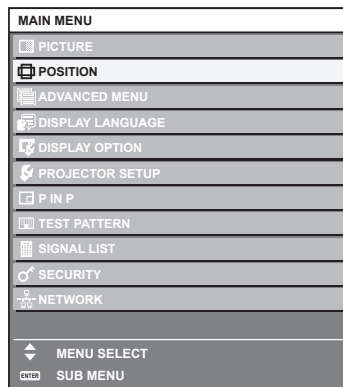

- 3) Press the <ENTER> button.
 - The sub-menu items of the selected main menu are displayed.

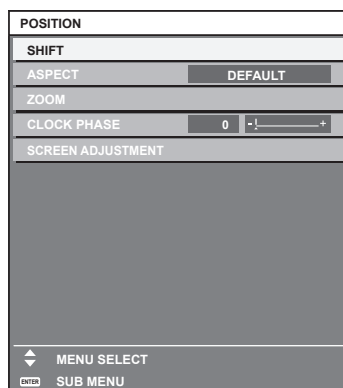

4) Press ▲▼ to select a sub-menu, and press ◀▶ or the <ENTER> button to change or adjust settings.

- Some items will switch in order as follows each time you press ◀▶.

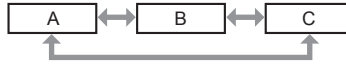

- For some items, press ◀▶ to display an individual adjustment screen with a bar scale as shown below.



Note

- Pressing the <MENU> button while the menu screen is displayed returns to the previous menu. Same operation is available by pressing the <RETURN> button.
- Some items or functions may not be adjusted or used for certain signals to be input to the projector. When the items cannot be adjusted or used, the items in the menu screen are shown in black characters, and they cannot be adjusted or set. If the item in the menu screen is displayed in black characters and the item cannot be adjusted or set, the factor causing it is displayed by pressing the <ENTER> button while the corresponding menu is selected.
- Some items can be adjusted even if signals are not input.
- Individual adjustment screen is cleared automatically if no operation is performed for approximately five seconds.
- For menu items, refer to “Main menu” (➔ page 58) and “Sub-menu” (➔ page 59).
- The cursor color depends on the setting in the [DISPLAY OPTION] menu → [ON-SCREEN DISPLAY] → [OSD DESIGN]. The selected item is displayed with the yellow cursor by the factory default.
- In the portrait setting, the on-screen menu is displayed sideways. To display the on-screen menu vertically, change the setting of the [DISPLAY OPTION] menu → [ON-SCREEN DISPLAY] → [OSD ROTATION].

Resetting adjustment values to the factory default

If the <DEFAULT> button on the remote control is pressed, the values adjusted in the menu items are restored to the factory default settings.



1) Press the <DEFAULT> button on the remote control.



Note

- You cannot reset all the settings to the factory default at a time.
- To reset all the settings adjusted in the sub-menu item to the factory default one at a time, execute the [PROJECTOR SETUP] menu → [INITIALIZE].
- Some items cannot be reset to the factory default settings even when the <DEFAULT> button on the remote control is pressed. Adjust those items individually.
- The triangular mark under the bar scale in the individual adjustment screen indicates the factory default setting. The position of the triangular mark varies according to the selected input signals.

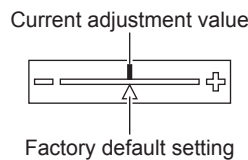









Main menu

The following items are in the main menu.

When a main menu item is selected, the screen changes to a sub-menu selection screen.

Main menu item		Page
	[PICTURE]	62
	[POSITION]	68
	[ADVANCED MENU]	73

Main menu item		Page
	[DISPLAY LANGUAGE]	78
	[DISPLAY OPTION]	79
	[PROJECTOR SETUP]	95
	[P IN P]	112
	[TEST PATTERN]	114
	[SIGNAL LIST]	115
	[SECURITY]	118
	[NETWORK]	122

Sub-menu

The sub-menu of the selected main menu item is displayed, and you can set and adjust items in the sub-menu.

[PICTURE]

Sub-menu item	Factory default	Page
[PICTURE MODE]	[GRAPHIC] ^{*1}	62
[CONTRAST]	[0]	62
[BRIGHTNESS]	[0]	62
[COLOR]	[0] ^{*2}	63
[TINT]	[0]	63
[COLOR TEMPERATURE]	[DEFAULT] ^{*2}	63
[WHITE GAIN]	[+10]	64
[GAMMA]	[DEFAULT]	65
[DAYLIGHT VIEW]	[AUTO] ^{*2}	65
[SHARPNESS]	[+6] ^{*2}	65
[NOISE REDUCTION]	[OFF] ^{*2}	66
[DYNAMIC CONTRAST]	[OFF] ^{*2}	66
[SYSTEM SELECTOR]	[AUTO] ^{*1}	66

*1 Depends on the signal input.

*2 Depends on the [PICTURE MODE].

[POSITION]

Sub-menu item	Factory default	Page
[SHIFT]	—	68
[ASPECT]	[DEFAULT] ^{*1}	68
[ZOOM]	—	69
[CLOCK PHASE]	[0] ^{*1}	70
[SCREEN ADJUSTMENT]	[OFF]	70

*1 Depends on the signal input.

[ADVANCED MENU]

Sub-menu item	Factory default	Page
[DIGITAL CINEMA REALITY]	[AUTO] ^{*1}	73
[BLANKING]	—	73
[INPUT RESOLUTION]	—	74

Sub-menu item	Factory default	Page
[CLAMP POSITION]	[24] ^{*1}	74
[EDGE BLENDING]	[OFF]	74
[FRAME RESPONSE]	[NORMAL]	76
[RASTER POSITION]	—	77

*1 Depends on the signal input.

Note

- The factory default setting varies depending on the selected input terminal.

[DISPLAY LANGUAGE]

Details (➔ page 78)

[DISPLAY OPTION]

Sub-menu item	Factory default	Page
[COLOR MATCHING]	[OFF]	79
[COLOR CORRECTION]	[OFF]	80
[SCREEN SETTING]	—	80
[AUTO SIGNAL]	[OFF]	81
[AUTO SETUP]	—	81
[COMPUTER IN/OUT]	—	82
[DVI-D IN]	—	84
[HDMI IN]	—	85
[DIGITAL LINK IN]	—	86
[ON-SCREEN DISPLAY]	—	87
[CLOSED CAPTION SETTING]	—	89
[BACK COLOR]	[BLUE]	90
[STARTUP LOGO]	[DEFAULT LOGO]	90
[UNIFORMITY]	—	91
[SHUTTER SETTING]	—	92
[FREEZE]	—	93
[WAVEFORM MONITOR]	[OFF]	93
[CUT OFF]	—	94

[PROJECTOR SETUP]

Sub-menu item	Factory default	Page
[PROJECTOR ID]	[ALL]	95
[PROJECTION METHOD]	—	95
[ECO MANAGEMENT]	—	96
[BRIGHTNESS CONTROL]	—	99
[SCHEDULE]	[OFF]	103
[INITIAL STARTUP]	[LAST MEMORY]	105
[STARTUP INPUT SELECT]	[LAST USED]	105
[RS-232C]	—	106
[FUNCTION BUTTON]	—	106
[AUDIO SETTING]	—	107
[STATUS]	—	108
[DATE AND TIME]	—	109
[SAVE ALL USER DATA]	—	110
[LOAD ALL USER DATA]	—	110
[INITIALIZE]	—	111
[SERVICE PASSWORD]	—	111

[P IN P] 

Details (➔ page 112)

[TEST PATTERN] 

Details (➔ page 114)

[SIGNAL LIST] 

Details (➔ page 115)

[SECURITY] 

Sub-menu item	Factory default	Page
[SECURITY PASSWORD]	[OFF]	118
[SECURITY PASSWORD CHANGE]	—	118
[DISPLAY SETTING]	[OFF]	118
[TEXT CHANGE]	—	119
[CONTROL DEVICE SETUP]	—	119
[CONTROL DEVICE PASSWORD CHANGE]	—	120

[NETWORK] 

Sub-menu item	Factory default	Page
[DIGITAL LINK MODE]	[AUTO]	122
[DIGITAL LINK STATUS]	—	122
[NETWORK SETUP]	—	123
[NETWORK CONTROL]	—	123
[NETWORK STATUS]	—	124
[DIGITAL LINK MENU]	—	124
[Art-Net SETUP]	[OFF]	124
[Art-Net CHANNEL SETTING]	[2]	125
[Art-Net STATUS]	—	125

Note

- Some items may not be adjusted or used for certain signal formats to be input to the projector.
When the items cannot be adjusted or used, the items in the menu screen are shown in black characters, and they cannot be adjusted or set.
- The factory default setting varies depending on the selected input terminal.

[PICTURE] menu

On the menu screen, select [PICTURE] from the main menu, and select an item from the sub-menu. Refer to “Navigating through the menu” (➔ page 57) for the operation of the menu screen.

[PICTURE MODE]

You can switch to the desired picture mode suitable for the image source and the environment in which the projector is used.

- 1) Press ▲▼ to select [PICTURE MODE].
- 2) Press ◀▶ or the <ENTER> button.
 - The [PICTURE MODE] individual adjustment screen is displayed.
- 3) Press ◀▶ to switch the item.
 - The items will switch each time you press the button.

[STANDARD]	The image becomes suitable for moving images in general.
[CINEMA]	The image becomes suitable for movie contents.
[NATURAL]	The image becomes sRGB compliant.
[REC709]	The image becomes Rec.709 compliant when the setting other than [PICTURE MODE] is set to the factory default.
[DICOM SIM.]	The image becomes similar to that of DICOM Part 14 Grayscale Standard.
[DYNAMIC]	The light output is maximized for use in bright areas.
[GRAPHIC]	The image becomes suitable for input from the personal computer.

Note

- The factory default picture mode is [GRAPHIC] for still image input signals and [STANDARD] for movie-based input signals.
- Rec.709 is an abbreviation of “ITU-R Recommendation BT.709” and is a color standard of high-vision broadcasting.
- DICOM is an abbreviation of “Digital Imaging and COmmunication in Medicine” and is a standard for medical imaging devices. Although the DICOM name is used, the projector is not a medical device, and display images should not be used for medical purposes such as diagnosis.

[CONTRAST]

You can adjust the contrast of the colors.

- 1) Press ▲▼ to select [CONTRAST].
- 2) Press ◀▶ or the <ENTER> button.
 - The [CONTRAST] individual adjustment screen is displayed.
- 3) Press ◀▶ to adjust the level.

Operation	Adjustment	Range of adjustment
Press ▶.	The screen becomes brighter.	-31 - +31
Press ◀.	The screen becomes darker.	

Attention

- Adjust the [PICTURE] menu → [BRIGHTNESS] first when you need to adjust the black level.

[BRIGHTNESS]

You can adjust the dark (black) part of the projected image.

- 1) Press ▲▼ to select [BRIGHTNESS].
- 2) Press ◀▶ or the <ENTER> button.
 - The [BRIGHTNESS] individual adjustment screen is displayed.
- 3) Press ◀▶ to adjust the level.

Operation	Adjustment	Range of adjustment
Press ▶.	Increases the brightness of the dark (black) parts of the screen.	-31 - +31
Press ◀.	Reduces the brightness of the dark (black) parts of the screen.	

[COLOR]

You can adjust the color saturation of the projected image.

- 1) Press ▲▼ to select [COLOR].
- 2) Press ◀▶ or the <ENTER> button.
 - The [COLOR] individual adjustment screen is displayed.
- 3) Press ◀▶ to adjust the level.

Operation	Adjustment	Range of adjustment
Press ▶.	Deepens colors.	-31 - +31
Press ◀.	Weakens colors.	

[TINT]

You can adjust the skin tone in the projected image.

- 1) Press ▲▼ to select [TINT].
- 2) Press ◀▶ or the <ENTER> button.
 - The [TINT] individual adjustment screen is displayed.
- 3) Press ◀▶ to adjust the level.

Operation	Adjustment	Range of adjustment
Press ▶.	Adjusts skin tone toward greenish color.	-31 - +31
Press ◀.	Adjusts skin tone toward reddish purple.	

[COLOR TEMPERATURE]

You can switch the color temperature if the white areas of the projected image are bluish or reddish.

Adjusting with color temperature

- 1) Press ▲▼ to select [COLOR TEMPERATURE].
- 2) Press ◀▶ or the <ENTER> button.
 - The [COLOR TEMPERATURE] individual adjustment screen is displayed.
- 3) Press ◀▶ to switch the item.
 - The items will switch each time you press the button.

[DEFAULT]	Factory default setting.
[USER]	Adjusts white balance as desired. Refer to "Adjusting desired white balance" (➔ page 63) for details.
[LOW]/[HIGH]	Select an item so that images become natural.

Note

- [DEFAULT] cannot be selected when the [PICTURE] menu → [PICTURE MODE] is set to [DICOM SIM].
- The item is fixed to [USER] when the [DISPLAY OPTION] menu → [COLOR MATCHING] is set to anything other than [OFF].

Adjusting desired white balance

- 1) Press ▲▼ to select [COLOR TEMPERATURE].
- 2) Press ◀▶ or the <ENTER> button.
 - The [COLOR TEMPERATURE] individual adjustment screen is displayed.
- 3) Press ◀▶ to select [USER].
- 4) Press the <ENTER> button.
 - The [COLOR TEMPERATURE] screen is displayed.

- 5) Press ▲▼ to select [WHITE BALANCE].
- 6) Press the <ENTER> button.
 - The [WHITE BALANCE] screen is displayed.
- 7) Press ▲▼ to select [WHITE BALANCE HIGH] or [WHITE BALANCE LOW].
- 8) Press the <ENTER> button.
 - The [WHITE BALANCE HIGH] screen or the [WHITE BALANCE LOW] screen is displayed.
- 9) Press ▲▼ to select [RED], [GREEN], or [BLUE].
- 10) Press ◀▶ to adjust the level.

Item	Operation	Adjustment	Range of adjustment
[RED]	Press ▶.	Deepens red.	[WHITE BALANCE HIGH]: 0 - +255 (factory default is +255) [WHITE BALANCE LOW]: -127 - +127 (factory default is 0)
	Press ◀.	Weakens red.	
[GREEN]	Press ▶.	Deepens green.	
	Press ◀.	Weakens green.	
[BLUE]	Press ▶.	Deepens blue.	
	Press ◀.	Weakens blue.	

Note

- Adjust [COLOR TEMPERATURE] correctly. All colors will not be displayed properly unless adequate adjustment is made. If the adjustment does not look suitable, you can press the <DEFAULT> button on the remote control to return the setting for the selected item only to the factory default setting.

Changing the [USER] name

- 1) Press ▲▼ to select [COLOR TEMPERATURE].
- 2) Press ◀▶ or the <ENTER> button.
 - The [COLOR TEMPERATURE] individual adjustment screen is displayed.
- 3) Press ◀▶ to select [USER].
- 4) Press the <ENTER> button.
 - The [COLOR TEMPERATURE] screen is displayed.
- 5) Press ▲▼ to select [COLOR TEMPERATURE NAME CHANGE].
- 6) Press the <ENTER> button.
 - The [COLOR TEMPERATURE NAME CHANGE] screen is displayed.
- 7) Press ▲▼◀▶ to select the text, and press the <ENTER> button to enter the text.
- 8) Press ▲▼◀▶ to select [OK], and press the <ENTER> button.
 - The name set to color temperature is changed.

Note

- When a name is changed, display of [USER] is also changed.

[WHITE GAIN]

Adjust the brightness of the white part of the image.

- 1) Press ▲▼ to select [WHITE GAIN].
- 2) Press ◀▶ or the <ENTER> button.
 - The [WHITE GAIN] individual adjustment screen is displayed.
- 3) Press ◀▶ to adjust the level.

Operation	Adjustment	Range of adjustment
Press ►.	Brightness of the white part gets stronger.	0 - +10
Press ◀.	The image becomes more natural.	

[GAMMA]

You can switch gamma mode.

- 1) Press ▲▼ to select [GAMMA].
- 2) Press ◀▶ or the <ENTER> button.
 - The [GAMMA] individual adjustment screen is displayed.
- 3) Press ◀▶ to switch the item.
 - The items will switch each time you press the button.

[DEFAULT]	Factory default setting.
[1.8]	Set so that images become as you like.
[2.0]	
[2.2]	

Note

- In the following conditions, the [DEFAULT] setting is disabled even when it is selected, and the same gamma mode as when [2.2] is set is applied.
 - When the [ADVANCED MENU] menu → [EDGE BLENDING] is set to anything other than [OFF]
 - When the levels of [WHITE], [RED], [GREEN], and [BLUE] are adjusted from the [DISPLAY OPTION] menu → [UNIFORMITY]
 - When the [DISPLAY OPTION] menu → [UNIFORMITY] → [PC CORRECTION] is set to [ON]

[DAYLIGHT VIEW]

You can correct the image to the optimal vividness even if it is projected under a bright light.

- 1) Press ▲▼ to select [DAYLIGHT VIEW].
- 2) Press ◀▶ or the <ENTER> button.
 - The [DAYLIGHT VIEW] individual adjustment screen is displayed.
- 3) Press ◀▶ to switch the item.
 - The items will switch each time you press the button.

[AUTO]	Detects the brightness of the installed environment by the luminance sensor, and automatically corrects the vividness of the image.
[OFF]	No correction.
[1]	Corrects the image to weaken vividness.
[2]	Corrects the image to medium vividness.
[3]	Corrects the image to high vividness.

Note

- [AUTO] cannot be selected when the [ADVANCED MENU] menu → [EDGE BLENDING] is set to [ON] or [USER].
- [AUTO] cannot be selected when the [PROJECTOR SETUP] menu → [FRONT/REAR] of [PROJECTION METHOD] is set to [REAR].
- The luminance may not be detected correctly when an object is placed on top of the projector, blocking the luminance sensor. In such a case, this function may not operate properly even if it is set to [AUTO].
- The factory default setting is [OFF] when the [PICTURE] menu → [PICTURE MODE] is set to [NATURAL], [REC709], or [DICOM SIM.]. In this case, [AUTO] cannot be selected.

[SHARPNESS]

You can adjust the sharpness of the projected image.

- 1) Press ▲▼ to select [SHARPNESS].
- 2) Press ◀▶ or the <ENTER> button.
 - The [SHARPNESS] individual adjustment screen is displayed.
- 3) Press ◀▶ to adjust the level.

Operation	Adjustment	Range of adjustment
Press ►.	Contours become sharper.	0 - +15
Press ◀.	Contours become softer.	

Note

- If you press ► while the adjustment value is [+15], the value will become [0]. If you press ◀ while the adjustment value is [0], the value will become [+15].

[NOISE REDUCTION]

You can reduce noises when the input image is degraded and noise is occurring in the image signal.

- 1) Press ▲▼ to select [NOISE REDUCTION].
- 2) Press ◀▶ or the <ENTER> button.
 - The [NOISE REDUCTION] individual adjustment screen is displayed.
- 3) Press ◀▶ to switch the item.
 - The items will switch each time you press the button.

[OFF]	No correction.
[1]	Slightly corrects the noise.
[2]	Moderately corrects the noise.
[3]	Strongly corrects the noise.

Attention

- When this is set for an input signal with less noise, the image may look different from the original image. In such a case, set it to [OFF].

[DYNAMIC CONTRAST]

Light adjustment of the light source is performed automatically according to the image to make the contrast optimum for the image.

- 1) Press ▲▼ to select [DYNAMIC CONTRAST].
- 2) Press ◀▶ or the <ENTER> button.
 - The [DYNAMIC CONTRAST] individual adjustment screen is displayed.
- 3) Press ◀▶ to switch the item.
 - The items will switch each time you press the button.

[OFF]	Disables the dynamic contrast function.
[ON]	Executes the light adjustment of the light source.

Note

- The brightness control function and the dynamic contrast function will operate simultaneously, but the dynamic contrast function will not operate while measuring the brightness and the color.

[SYSTEM SELECTOR]

The projector will automatically detect the input signal, but you can set the system method manually when an unstable signal is input. Set the system method matching the input signal.

- 1) Press ▲▼ to select [SYSTEM SELECTOR].
- 2) Press the <ENTER> button.
- 3) Press ▲▼ to select a system format.
 - Available system formats vary depending on the input signal.

Terminal	System format
<VIDEO IN> terminal, <COMPUTER 1 IN> terminal*	Select [AUTO], [NTSC], [NTSC4.43], [PAL], [PAL-M], [PAL-N], [SECAM], or [PAL60]. Select [AUTO] normally. ([AUTO] will automatically determine from [NTSC], [NTSC4.43], [PAL], [PAL-M], [PAL-N], [SECAM], or [PAL60].) Switch the setting to the appropriate TV signal format.

Terminal	System format	
<COMPUTER 1 IN> terminal*2, <COMPUTER 2 IN/1 OUT> terminal	480i, 576i, or 576p signal	Select [RGB] or [Y _C B _R].
	VGA60 or 480p signal	Select [VGA60], [480p Y _C B _R], or [480p RGB].
	Other moving image signals	Select [RGB] or [Y _P B _R].
<DVI-D IN> terminal	480i, 576i, 480p, or 576p signal	Select [RGB] or [Y _C B _R].
	Other moving image signals	Select [RGB] or [Y _P B _R].
<HDMI 1 IN> terminal, <HDMI 2 IN> terminal, <DIGITAL LINK/LAN> terminal	480i, 576i, 480p, or 576p signal	Select [AUTO], [RGB], or [Y _C B _R].
	Other moving image signals	Select [AUTO], [RGB], or [Y _P B _R].

*1 When the [DISPLAY OPTION] menu → [COMPUTER IN/OUT] → [INPUT SETTING] is set to [Y/C]

*2 When the [DISPLAY OPTION] menu → [COMPUTER IN/OUT] → [INPUT SETTING] is set to [RGB/Y_PB_R]

4) Press the <ENTER> button.

Note

- For details of the types of video signals that can be used with the projector, refer to “List of compatible signals” (➔ page 167).
- This may not function properly for some connected external devices.

sRGB-compliant video

sRGB is an international standard (IEC61966-2-1) for color reproduction defined by IEC (International Electrotechnical Commission).

Set according to the following steps to reproduce more faithful, sRGB compliant colors.

- 1) Set [COLOR MATCHING] to [OFF].
 - Refer to [COLOR MATCHING] (➔ page 79).
- 2) Display the [PICTURE] menu.
 - Refer to “[PICTURE] menu” (➔ page 62).
- 3) Press ▲▼ to select [PICTURE MODE].
- 4) Press ◀▶ to set [NATURAL].
- 5) Press ▲▼ to select [COLOR].
- 6) Press the <DEFAULT> button on the remote control to set the factory default setting.
- 7) Follow Steps 5) to 6) to set [TINT], [COLOR TEMPERATURE], [WHITE GAIN], [GAMMA], and [DAYLIGHT VIEW] to the factory default settings.

Note

- sRGB is available for RGB signal input only.

[POSITION] menu

On the menu screen, select [POSITION] from the main menu, and select an item from the sub-menu. Refer to “Navigating through the menu” (➔ page 57) for the operation of the menu screen.

Note

- When the optional DIGITAL LINK output supported device (Model No.: ET-YFB100G, ET-YFB200G) is connected to the <DIGITAL LINK/ LAN> terminal, adjust the shift, aspect, and clock phase from the menu of DIGITAL LINK output supported device at first.

[SHIFT]

Move the image position vertically or horizontally if the image projected on the screen is still out of position even when the positions of the projector and screen are correct.

- Press ▲▼ to select [SHIFT].
- Press the <ENTER> button.
 - The [SHIFT] screen is displayed.
- Press ▲▼◀▶ to adjust the position.

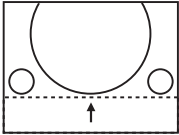
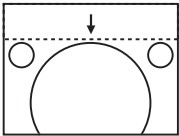
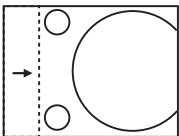
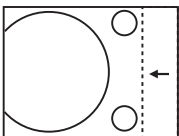
Orientation	Operation	Adjustment	
Vertical (up and down) adjustment	Press ▲.	The image position moves up.	
	Press ▼.	The image position moves down.	
Horizontal (right and left) adjustment	Press ▶.	The image position moves to the right.	
	Press ◀.	The image position moves to the left.	

Note

- For the portrait setting, image position is moved horizontally when “Vertical (up and down) adjustment” is made. Image position is moved vertically when “Horizontal (right and left) adjustment” is made.

[ASPECT]

You can switch the aspect ratio of the image.

The aspect ratio is switched within the screen range selected in the [DISPLAY OPTION] menu → [SCREEN SETTING] → [SCREEN FORMAT]. Set [SCREEN FORMAT] first. (➔ page 80)

- Press ▲▼ to select [ASPECT].
- Press ◀▶ or the <ENTER> button.
 - The [ASPECT] individual adjustment screen is displayed.
- Press ◀▶ to switch the item.
 - The items will switch each time you press the button.

[DEFAULT]	Displays images without changing the aspect ratio of the input signals.
[VID AUTO]*1	Identifies the video ID (VID) embedded in the video signal, and automatically switches the image size between 4:3 and 16:9. This is enabled when NTSC signal is input.

[AUTO] ^{*2}	Identifies the video ID (VID) embedded in the video signal, and automatically switches the image size between 4:3 and 16:9. This is enabled when 480i/480p signal is input.
[THROUGH]	Displays images without changing the resolution of the input signals.
[16:9]	Displays images with the aspect ratio converted to 16:9 when standard signals are input ^{*3} . When wide-screen signals are input ^{*4} , the images are displayed without changing the aspect ratio.
[4:3]	Displays images without changing the aspect ratio when standard signals are input ^{*3} . When wide-screen signals are input ^{*4} , the images are reduced to be displayed without changing input aspect ratio so that the images will fit in the 4:3 screen.
[H FIT]	Displays images using the entire width of the screen range selected in [SCREEN FORMAT]. When signals have the aspect ratio vertically longer than the screen aspect ratio selected in [SCREEN FORMAT], the images are displayed with the top and bottom parts cut off.
[V FIT]	Displays images using the entire height of the screen range selected in [SCREEN FORMAT]. When signals have the aspect ratio horizontally longer than the aspect ratio of the screen selected in [SCREEN FORMAT], the images are displayed with the right and left parts cut off.
[HV FIT]	Displays images in the entire screen range selected in [SCREEN FORMAT]. When the aspect ratio of the input signals differs from that of the screen range, the images are displayed with the aspect ratio converted to that of the screen selected in [SCREEN FORMAT].

*1 During video signals and Y/C signal (NTSC) input only

*2 During RGB signal (480i, 480p) input only

*3 Standard signals are input signals with an aspect ratio of 4:3 or 5:4.

*4 Wide-screen signals are input signals with an aspect ratio of 16:10, 16:9, 15:9 or 15:10.

Note

- Some size modes are not available for certain types of input signals. [DEFAULT] cannot be selected for video signal, Y/C signal (NTSC), or RGB (480i, 480p) signal.
- If an aspect ratio which is different from the aspect ratio for the input signals is selected, the images will appear differently from the originals. Be careful of this when selecting the aspect ratio.
- If using the projector in places such as cafes or hotels to display programs for a commercial purpose or for public presentation, note that adjusting the aspect ratio or using the zoom function to change the screen images may be an infringement of the rights of the original copyright owner for that program under copyright protection laws. Take care when using a function of the projector such as the aspect ratio adjustment and zoom function.
- If conventional (normal) 4:3 images which are not wide-screen images are displayed on a wide screen, the edges of the images may not be visible or they may become distorted. Such images should be viewed as with an aspect ratio of 4:3 in the original format intended by the creator of the images.

[ZOOM]

You can adjust the image size.

The adjustments in [ZOOM] will differ depending on the setting of the [POSITION] menu → [ASPECT].

When [ASPECT] is set to other than [DEFAULT] and [THROUGH]

- 1) Press ▲▼ to select [ZOOM].
- 2) Press the <ENTER> button.
 - The [ZOOM] screen is displayed.
- 3) Press ▲▼ to select [INTERLOCKED].
- 4) Press ◀▶ to switch the item.

[OFF]	Sets the [VERTICAL] and [HORIZONTAL] zoom ratio.
[ON]	Uses [BOTH] to set zoom ratio. Image can be enlarged or reduced vertically and horizontally at the same magnification.

- 5) Press ▲▼ to select [VERTICAL] or [HORIZONTAL].
 - If [ON] is selected, select [BOTH].
- 6) Press ◀▶ to adjust.

Note

- When the [POSITION] menu → [ASPECT] is set to [THROUGH], [ZOOM] cannot be adjusted.

When [ASPECT] is set to [DEFAULT]

- 1) Press ▲▼ to select [ZOOM].

- 2) Press the <ENTER> button.
 - The [ZOOM] screen is displayed.
- 3) Press ▲▼ to select [MODE].
- 4) Press ◀▶ to switch the item.

[INTERNAL]	Enlarges the size within the aspect range set with [SCREEN FORMAT].
[FULL]	Enlarges or reduces the size using the entire display area set with [SCREEN FORMAT].

- 5) Press ▲▼ to select [INTERLOCKED].
- 6) Press ◀▶ to switch the item.

[OFF]	Sets the [VERTICAL] and [HORIZONTAL] zoom ratio.
[ON]	Uses [BOTH] to set zoom ratio. Image can be enlarged or reduced vertically and horizontally at the same magnification.

- 7) Press ▲▼ to select [VERTICAL] or [HORIZONTAL].
 - If [ON] is selected, select [BOTH].
- 8) Press ◀▶ to adjust.

Note

- When the [POSITION] menu → [ASPECT] is set to anything other than [DEFAULT], [MODE] is not displayed.

[CLOCK PHASE]

You can adjust the image to achieve an optimal image when there is a flickering image or smeared outlines.

- 1) Press ▲▼ to select [CLOCK PHASE].
- 2) Press ◀▶ or the <ENTER> button.
 - The [CLOCK PHASE] individual adjustment screen is displayed.
- 3) Press ◀▶ to adjust.
 - Adjustment value will change between [0] and [+31]. Adjust the image so that the amount of interference is at a minimum.

Note

- Adjustment may not be possible depending on the signal.
- There may be no optimal value if the output from the input computer is unstable.
- There may be no optimal value when the total dot number is shifted.
- [CLOCK PHASE] can be adjusted when YC_BC_R/YP_BP_R signal or analog RGB signal is input to the <COMPUTER 1 IN> terminal or the <COMPUTER 2 IN/1 OUT> terminal.
- [CLOCK PHASE] cannot be adjusted when a digital signal is input.
- The adjustment value will change to [0] when ▶ is pressed while it was at [+31]. Also, the adjustment value will change to [+31] when ◀ is pressed while it was at [0].

[SCREEN ADJUSTMENT]

You can correct various types of distortion in a projected image.



Unique image processing technology enables projection of a square image on a special screen shape.

- 1) Press ▲▼ to select [SCREEN ADJUSTMENT].
- 2) Press ◀▶ to switch the item.
 - The items will switch each time you press the button.

[OFF]	Does not perform [SCREEN ADJUSTMENT].
[KEYSTONE]	Adjusts any trapezoidal distortion in the projected image.
[CORNER CORRECTION]	Adjusts any distortion in the four corners of the projected image.
[CURVED CORRECTION]	Adjusts any curved distortion in the projected image.

Setting [KEYSTONE] or [CURVED CORRECTION]

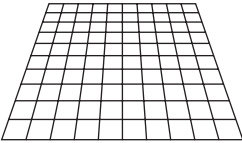
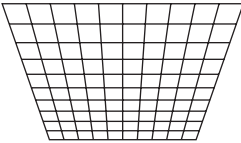
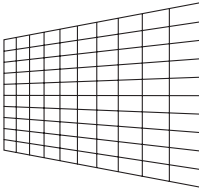
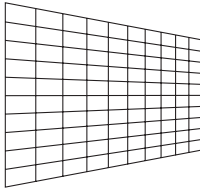
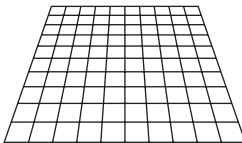
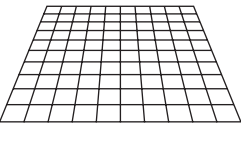
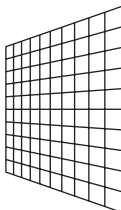
- 1) Press ▲▼ to select [SCREEN ADJUSTMENT].
- 2) Press ◀▶ to select [KEYSTONE] or [CURVED CORRECTION].
- 3) Press the <ENTER> button.
 - The [KEYSTONE] or [CURVED CORRECTION] screen is displayed.
- 4) Press ▲▼ to select the item to adjust.
- 5) Press ◀▶ to adjust.

[KEYSTONE]			
<p>[LENS THROW RATIO] Set the throw ratio. Select the value close to the actual projection distance divided by projected image width here.</p>			
<p>[VERTICAL KEYSTONE]</p> <div style="display: flex; justify-content: space-around;">   </div>	<p>[HORIZONTAL KEYSTONE]</p> <div style="display: flex; justify-content: space-around;">   </div>		
<p>[VERTICAL BALANCE]</p> <div style="display: flex; justify-content: space-around;">   </div> <p style="font-size: small;">Adjust the setting according to the lens shift range in the vertical direction.</p>	<p>[HORIZONTAL BALANCE]</p> <div style="display: flex; justify-content: space-around;">   </div> <p style="font-size: small;">Adjust the setting according to the lens shift range in the horizontal direction.</p>		

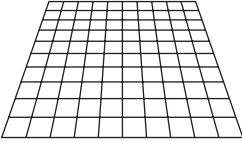
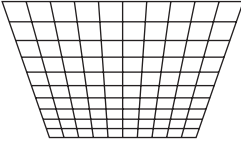
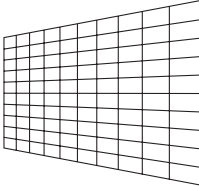
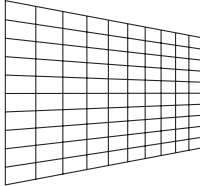
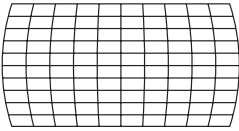
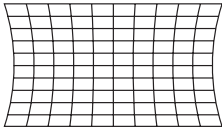
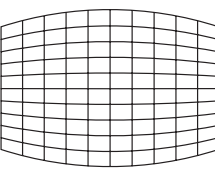
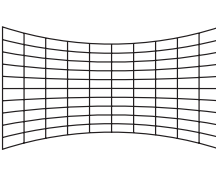
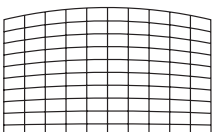
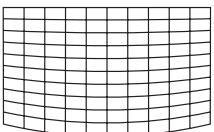
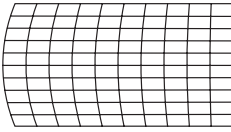
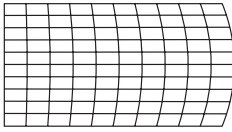
[CURVED CORRECTION]			
<p>[LENS THROW RATIO] Set the throw ratio. Select the value close to the actual projection distance divided by projected image width here.</p>			
<p>[VERTICAL KEYSTONE]</p> <div style="display: flex; justify-content: space-around;">   </div>	<p>[HORIZONTAL KEYSTONE]</p> <div style="display: flex; justify-content: space-around;">   </div>		
<p>[VERTICAL ARC]</p> <div style="display: flex; justify-content: space-around;">   </div>	<p>[HORIZONTAL ARC]</p> <div style="display: flex; justify-content: space-around;">   </div>		
<p>[VERTICAL BALANCE]</p> <div style="display: flex; justify-content: space-around;">   </div>	<p>[HORIZONTAL BALANCE]</p> <div style="display: flex; justify-content: space-around;">   </div>		
<p>[MAINTAIN ASPECT RATIO] Select [ON] to correct while keeping the aspect ratio.</p>			

Setting [CORNER CORRECTION]

- 1) Press ▲▼ to select [SCREEN ADJUSTMENT].
- 2) Press ◀▶ to select [CORNER CORRECTION].
- 3) Press the <ENTER> button.
 - The [CORNER CORRECTION] screen is displayed.
- 4) Press ▲▼ to select the item to adjust, and press the <ENTER> button.
- 5) Press ▲▼◀▶ to adjust.

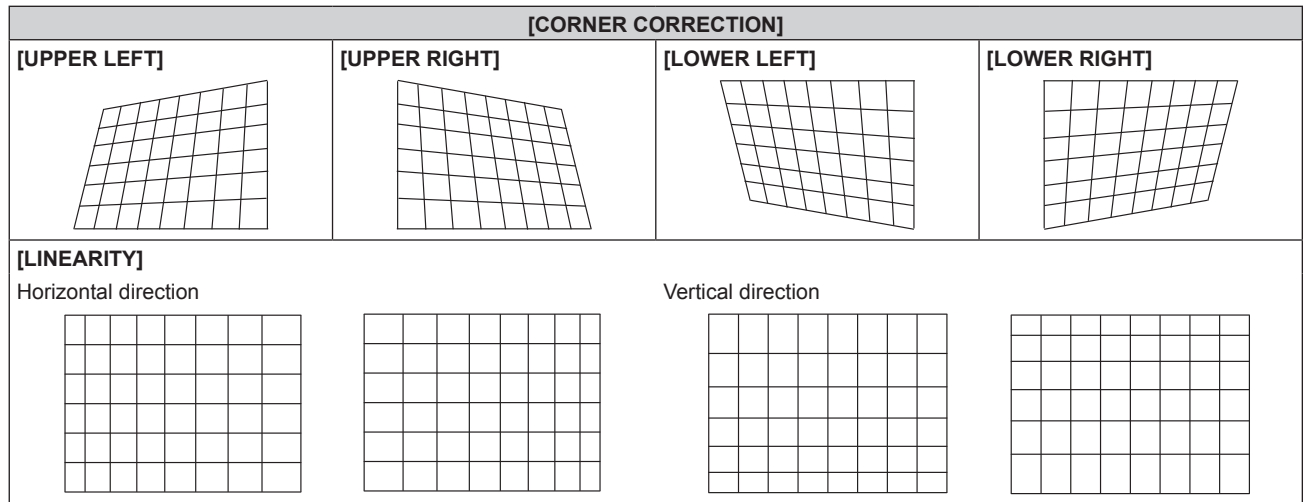
**Note**

- The picture quality will degrade more when the correction for [SCREEN ADJUSTMENT] increases, making it harder to focus. Install the projector so that the correction will be as small as possible.
- Image size will also change when [SCREEN ADJUSTMENT] is used to perform various adjustments.
- If [SCREEN ADJUSTMENT] and the adjustment in the [ADVANCED MENU] menu → [EDGE BLENDING] are used together, the edge blending may not be adjusted correctly depending on the environment.
- The image may disappear for a moment or may be disrupted while performing adjustment, but this is not a malfunction.

[ADVANCED MENU] menu

On the menu screen, select [ADVANCED MENU] from the main menu, and select an item from the sub-menu.

Refer to “Navigating through the menu” (➔ page 57) for the operation of the menu screen.

[DIGITAL CINEMA REALITY]

You can increase the vertical resolution and enhance the picture quality by performing cinema processing when the PAL (or SECAM) 576i signal, the NTSC 480i signal, and 1080/50i, 1080/60i are input.

- 1) Press ▲▼ to select [DIGITAL CINEMA REALITY].
- 2) Press ◀▶ to switch the item.
 - The items will switch each time you press the button.

[AUTO]	Automatically detects the signal and performs the cinema processing. (Factory default setting)	
[OFF]	Does not perform cinema processing.	
[30p FIXED]	When 480i or 1080/60i signal is input	Performs forced cinema processing (2:2 pull-down).
[25p FIXED]	When 576i or 1080/50i signal is input	

Note

- In [DIGITAL CINEMA REALITY], the picture quality will degrade when a signal other than the 2:2 pull-down is set as [25p FIXED] or [30p FIXED]. (Vertical resolution will degrade.)
- When the [ADVANCED MENU] menu → [FRAME RESPONSE] is set to [FAST], [DIGITAL CINEMA REALITY] cannot be set.

[BLANKING]

You can adjust the blanking width if there are noises at the edge of the screen or the image is slightly running out from the screen while an image from the VCR or other devices are projected.

- 1) Press ▲▼ to select [BLANKING].
- 2) Press the <ENTER> button.
 - The [BLANKING] adjustment screen is displayed.
- 3) Press ▲▼ to select [UPPER], [LOWER], [LEFT], or [RIGHT].
- 4) Press ◀▶ to adjust the blanking width.

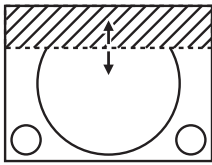
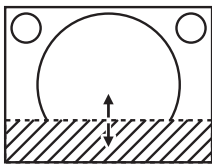
Blanking correction	Item	Operation	Adjustment	Range of adjustment	
Top of the screen	[UPPER]	Press ◀.	The blanking zone moves upward.		Top to bottom 0 - 599
		Press ▶.	The blanking zone moves downward.		
Bottom of the screen	[LOWER]	Press ▶.	The blanking zone moves upward.		
		Press ◀.	The blanking zone moves downward.		

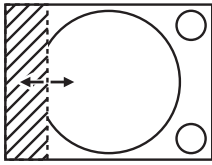
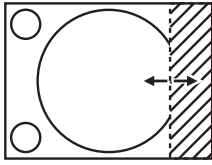
Blanking correction	Item	Operation	Adjustment	Range of adjustment	
Left side of the screen	[LEFT]	Press ▶.	The blanking zone moves to the right.		Left and right 0 - 959
		Press ◀.	The blanking zone moves to the left.		
Right side of the screen	[RIGHT]	Press ◀.	The blanking zone moves to the right.		
		Press ▶.	The blanking zone moves to the left.		

[INPUT RESOLUTION]

You can adjust the image to achieve an optimal image when there is a flickering image or smeared outlines.

- 1) Press ▲▼ to select [INPUT RESOLUTION].
- 2) Press the <ENTER> button.
 - The [INPUT RESOLUTION] screen is displayed.
- 3) Press ▲▼ to select [TOTAL DOTS], [DISPLAY DOTS], [TOTAL LINES], or [DISPLAY LINES], and press ◀▶ to adjust each item.
 - Values corresponding to the signal being input are displayed automatically for each item. Increase or decrease the displayed values and adjust to the optimal point while viewing the screen if there are vertical stripes or sections are missing from the screen.

Note

- Previously mentioned vertical banding will not occur with all white signal input.
- Image may be disrupted during automatic adjustment, but this is not a malfunction.
- [INPUT RESOLUTION] can be adjusted only when an RGB signal is input to the <COMPUTER 1 IN> terminal or the <COMPUTER 2 IN/1 OUT> terminal.
- Adjustment may not be possible depending on the signal.

[CLAMP POSITION]

You can adjust the optimal point when the black part of the image is blunt or it has turned green.

- 1) Press ▲▼ to select [CLAMP POSITION].
- 2) Press ◀▶ to adjust.

Status	Rough guide for optimal value	Range of adjustment
The black part is blunt.	The point where bluntness of the black part improves the most is the optimal value.	1 - 255
The black part is green.	The point where the green part becomes black, and the bluntness has improved is the optimal value.	

Note

- [CLAMP POSITION] can be adjusted only when a signal is input to the <COMPUTER 1 IN> terminal or the <COMPUTER 2 IN/1 OUT> terminal.
- Adjustment may not be possible depending on the signal.

[EDGE BLENDING]

The edge blending function allows multiple images to be seamlessly overlapped by using the inclination of the brightness at the overlapped area.

- 1) Press ▲▼ to select [EDGE BLENDING].
- 2) Press ◀▶ to switch the item.
 - The items will switch each time you press the button.

[OFF]	Sets the edge blending function to off.
-------	---

[ON]	Use the setting value preset in the projector for the inclination of the edge blending area.
[USER]	Use the user-setting value for the inclination of the edge blending area. (Configuration/registration requires separate software. Consult your dealer.)

- Proceed to Step 3) when anything other than [OFF] is selected.

3) Press the <ENTER> button.

- The [EDGE BLENDING] screen is displayed.

4) Press ▲▼ to specify the location to be corrected.

- When joining at top: Set [UPPER] to [ON]
- When joining at bottom: Set [LOWER] to [ON]
- When joining at left: Set [LEFT] to [ON]
- When joining at right: Set [RIGHT] to [ON]

5) Press ◀▶ to switch to [ON].

6) Press ▲▼ to select [START] or [WIDTH].

7) Press ◀▶ to adjust the starting position or correction width.

8) Press ▲▼ to select [MARKER].

9) Press ◀▶ to switch to [ON].

- A marker for image position adjustment is displayed. The position where the red and green lines overlap for the projectors to be joined will be the optimal point. Make sure to set the correction width for the projectors to be joined with the same value. Optimal joining is not possible with projectors that have different correction widths.

The optimal point is the point at which these lines overlap.

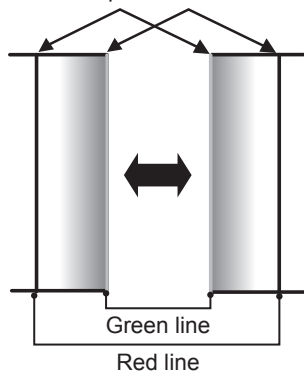

10) Press ▲▼ to select [BRIGHTNESS ADJUST].

11) Press the <ENTER> button.

- The [BRIGHTNESS ADJUST] screen is displayed.
- By setting [AUTO TESTPATTERN] to [ON] on the [EDGE BLENDING] screen, the black test pattern is displayed when you enter the [BRIGHTNESS ADJUST] screen.

12) Press ▲▼ to select [NON-OVERLAPPED BLACK LEVEL].

13) Press the <ENTER> button.

- The [NON-OVERLAPPED BLACK LEVEL] screen is displayed.
- [RED], [GREEN], and [BLUE] can be adjusted individually if [INTERLOCKED] is set to [OFF].

14) Press ▲▼ to select an item, and press ◀▶ to adjust the setting.

- Once the adjustment is completed, press the <MENU> button to return to the [BRIGHTNESS ADJUST] screen.

15) Press ▲▼ to select [UPPER], [LOWER], [LEFT], or [RIGHT] in [BLACK BORDER WIDTH].

16) Press ◀▶ to set the region (width) of the [BLACK BORDER WIDTH] adjustment.

17) Press ▲▼ to select [UPPER KEYSTONE AREA], [LOWER KEYSTONE AREA], [LEFT KEYSTONE AREA], or [RIGHT KEYSTONE AREA].

- 18) Press ◀▶ to adjust the tilt of the border between [NON-OVERLAPPED BLACK LEVEL] and [BLACK BORDER LEVEL].
- 19) Press ▲▼ to select [BLACK BORDER LEVEL].
- 20) Press the <ENTER> button.
 - The [BLACK BORDER LEVEL] screen is displayed.
 - [RED], [GREEN], and [BLUE] can be adjusted individually if [INTERLOCKED] is set to [OFF].
- 21) Press ▲▼ to select an item, and press ◀▶ to adjust the setting.
 - Once the adjustment is completed, press the <MENU> button to return to the [BRIGHTNESS ADJUST] screen.
- 22) Press ▲▼ to select [UPPER], [LOWER], [LEFT], or [RIGHT] for [OVERLAPPED BLACK LEVEL].
- 23) Press the <ENTER> button.
 - The [OVERLAPPED BLACK LEVEL] screen is displayed.
 - [RED], [GREEN], and [BLUE] can be adjusted individually if [INTERLOCKED] is set to [OFF].
- 24) Press ▲▼ to select an item, and press ◀▶ to adjust the setting.

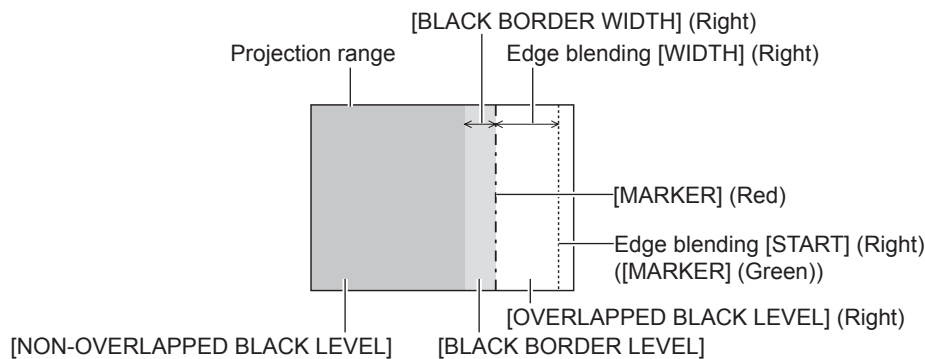

Note

- [BRIGHTNESS ADJUST] is a function that makes the increased brightness in black level of the overlapping image area difficult to notice when [EDGE BLENDING] is used to structure a multi-display screen. The optimal point of correction is set by adjusting [NON-OVERLAPPED BLACK LEVEL] so the black level of the overlapping image area will be the same level as the non-overlapping area. If the border area of the part where the image is overlapping and the non-overlapping part gets brighter after adjusting [NON-OVERLAPPED BLACK LEVEL], adjust the width of the top, bottom, left, or right. Adjust [BLACK BORDER LEVEL] when the width adjustment makes only the border area darker.
- The joining part may look discontinuous depending on the position you are looking from when a screen with high gain or rear screen is used.
- When structuring a multi-display screen using both horizontal and vertical edge blending, adjust [OVERLAPPED BLACK LEVEL] first before making adjustments in Step 12). Adjustment method is same as the procedure of [NON-OVERLAPPED BLACK LEVEL].
- If only horizontal or vertical edge blending is used, set all items in [OVERLAPPED BLACK LEVEL] to 0.
- The [AUTO TESTPATTERN] setting will change in conjunction with the setting in the [DISPLAY OPTION] menu → [COLOR MATCHING] → [AUTO TESTPATTERN].
- The tilt adjustment of the border between [NON-OVERLAPPED BLACK LEVEL] and [BLACK BORDER LEVEL] is a function to perform edge blending together with the adjustment in [SCREEN ADJUSTMENT] (➔ page 70). If the area of [NON-OVERLAPPED BLACK LEVEL] is tilted by correcting the keystone distortion with the [POSITION] menu → [SCREEN ADJUSTMENT] → [KEystone], perform Steps 17) and 18) to adjust the tilt and adjust the edge blending according to the shape of [NON-OVERLAPPED BLACK LEVEL].
- If [EDGE BLENDING] is set to anything other than [OFF], the setting of the [PICTURE] menu → [GAMMA] → [DEFAULT] is disabled, and the same gamma mode as when [2.2] is set is applied.

[FRAME RESPONSE]

Set image frame delay.

- 1) Press ▲▼ to select [FRAME RESPONSE].
- 2) Press ◀▶ to switch the item.
 - The items will switch each time you press the button.

[NORMAL]	Standard setting.
[FAST]	Simplifies the image processing to reduce image frame delay.

Note

- When [FAST] is set, the picture quality deteriorates. The [ADVANCED MENU] menu → [DIGITAL CINEMA REALITY] cannot be set.

- [FRAME RESPONSE] cannot be set while in the P IN P mode.

[RASTER POSITION]

This will allow the position of the image to move within the display area arbitrarily when the input image is not using the whole display area.

- 1) Press ▲▼ to select [RASTER POSITION].
- 2) Press the <ENTER> button.
 - The [RASTER POSITION] screen is displayed.
- 3) Press ▲▼◀▶ to adjust the position.

[DISPLAY LANGUAGE] menu

On the menu screen, select [DISPLAY LANGUAGE] from the main menu, and display the sub-menu. Refer to “Navigating through the menu” (➔ page 57) for the operation of the menu screen.

Changing the display language

You can select the language of the on-screen display.

1) Press ▲▼◀▶ to select the display language and press the <ENTER> button.

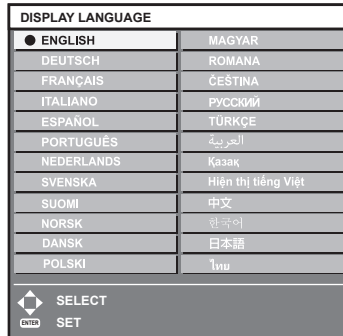

- Various menus, settings, adjustment screens, control button names, etc., are displayed in the selected language.
- The language can be switched to English, German, French, Italian, Spanish, Portuguese, Dutch, Swedish, Finnish, Norwegian, Danish, Polish, Hungarian, Romanian, Czech, Russian, Turkish, Arabic, Kazakh, Vietnamese, Chinese, Korean, Japanese, and Thai.

Note

- The on-screen display language is set to English in the factory default setting as well as when the [PROJECTOR SETUP] menu → [INITIALIZE] → [ALL USER DATA] is executed.

[DISPLAY OPTION] menu

On the menu screen, select [DISPLAY OPTION] from the main menu, and select an item from the sub-menu.

Refer to “Navigating through the menu” (➔ page 57) for the operation of the menu screen.

[COLOR MATCHING]

Correct the color difference between projectors when using multiple projectors simultaneously.

Adjusting the color matching as desired

- 1) Press ▲▼ to select [COLOR MATCHING].
- 2) Press ◀▶ to switch the item.
 - The items will switch each time you press the button.

[OFF]	Color matching adjustment is not carried out.
[3COLORS]	Adjusts the three colors [RED], [GREEN], or [BLUE].
[7COLORS]	Adjusts the seven colors [RED], [GREEN], [BLUE], [CYAN], [MAGENTA], [YELLOW], or [WHITE].
[MEASURED]	Refer to “Adjusting the color matching using a colorimeter” (➔ page 79) for details about this mode.

- 3) Select [3COLORS] or [7COLORS], and press the <ENTER> button.
 - The [3COLORS] or [7COLORS] screen is displayed.
- 4) Press ▲▼ to select [RED], [GREEN], [BLUE], or [WHITE] ([RED], [GREEN], [BLUE], [CYAN], [MAGENTA], [YELLOW], or [WHITE] when [7COLORS] is selected).
- 5) Press the <ENTER> button.
 - The [3COLORS:RED], [3COLORS:GREEN], [3COLORS:BLUE], or [3COLORS:WHITE] screen is displayed.
When [7COLORS] is selected, the [7COLORS:RED], [7COLORS:GREEN], [7COLORS:BLUE], [7COLORS:CYAN], [7COLORS:MAGENTA], [7COLORS:YELLOW], or [7COLORS:WHITE] screen is displayed.
 - By setting [AUTO TESTPATTERN] to [ON], the test pattern for the selected color is displayed.
- 6) Press ▲▼ to select [RED], [GREEN], or [BLUE].
 - Only [GAIN] can be adjusted when [WHITE] is selected for [3COLORS].
- 7) Press ◀▶ to adjust.
 - The adjustment value will change between 0*1 and 2 048.

*1 The lower limit varies depending on the color to be adjusted.

Note

- Operation when correcting the adjustment color
When the correction color same as the adjustment color is changed: The luminance of the adjustment color changes.
When correction color red is changed: Red is added to or subtracted from the adjustment color.
When correction color green is changed: Green is added to or subtracted from the adjustment color.
When correction color blue is changed: Blue is added to or subtracted from the adjustment color.
- Since advanced skills are necessary for the adjustment, this adjustment should be carried out by a person who is familiar with the projector or by a service person.
- Pressing the <DEFAULT> button on the remote control will restore the factory default settings for all items.
- When the item is set to anything other than [OFF], the [DISPLAY OPTION] menu → [COLOR CORRECTION] is fixed to [OFF], and the [PICTURE] menu → [COLOR TEMPERATURE] is fixed to [USER].

Adjusting the color matching using a colorimeter

Use a colorimeter that can measure chromaticity coordinates and luminance to change the colors [RED], [GREEN], [BLUE], [CYAN], [MAGENTA], [YELLOW], or [WHITE] to desired colors.

- 1) Press ▲▼ to select [COLOR MATCHING].
- 2) Press ◀▶ to select [MEASURED].

- 3) Press the <ENTER> button.
 - The [MEASURED MODE] screen is displayed.
- 4) Press ▲▼ to select [MEASURED DATA].
- 5) Press the <ENTER> button.
 - The [MEASURED DATA] screen is displayed.
- 6) Measure the current luminance (Y) and the chromaticity coordinates (x, y) using the colorimeter.
- 7) Press ▲▼ to select a color, and press ◀▶ to adjust the setting.
 - Set [AUTO TESTPATTERN] to [ON] to display a test pattern of selected colors.
- 8) Once all the input is completed, press the <MENU> button.
 - The [MEASURED MODE] screen is displayed.
- 9) Press ▲▼ to select [TARGET DATA].
- 10) Press the <ENTER> button.
 - The [TARGET DATA] screen is displayed.
- 11) Press ▲▼ to select a color and press ◀▶ to input coordinates for desired colors.
 - By setting [AUTO TESTPATTERN] to [ON], the test pattern for the selected color is displayed.
- 12) Once all the input is completed, press the <MENU> button.

Note

- Colors are not displayed properly when target data is a color outside the region of this projector.
- Set the [AUTO TESTPATTERN] to [ON] to automatically display a test pattern for use in adjusting the selected adjustment colors.
- The [AUTO TESTPATTERN] setting will change in conjunction with the setting in the [ADVANCED MENU] menu → [EDGE BLENDING] → [ON]/[USER] → [AUTO TESTPATTERN].
- When using a colorimeter or similar instrument to take measurement, measure the colors displayed in [AUTO TESTPATTERN].
- A difference in the color coordinates of target data and measurement value obtained from an instrument may occur for certain instrument and measurement environment used.

[COLOR CORRECTION]

Colors can be adjusted and registered for each input signal format.

- 1) Press ▲▼ to select [COLOR CORRECTION].
- 2) Press ◀▶ to switch the item.
 - The items will switch each time you press the button.

[OFF]	Standard setting
[USER]	For each of the four signal formats of VIDEO, Y/C, RGB, and YC _B C _R /YP _B P _R , six colors of red, green, blue, cyan, magenta, and yellow can be adjusted and registered. Press the <ENTER> button and set the details. Adjustment is possible within the range of -31 to +31.

[SCREEN SETTING]

Set the screen size.

Correct to the optimum image position for the set screen when the aspect ratio of a projected image is changed. Set as necessary for the screen in use.

- 1) Press ▲▼ to select [SCREEN SETTING].
- 2) Press the <ENTER> button.
 - The [SCREEN SETTING] screen is displayed.
- 3) Press ◀▶ to switch the [SCREEN FORMAT] item.
 - The items will switch each time you press the button.

[SCREEN FORMAT]	Range when [SCREEN POSITION] is selected
[16:10]	Cannot be adjusted.
[4:3]	Adjusts the horizontal position between -160 and 160.
[16:9]	Adjusts the vertical position between -60 and 60.

- 4) Press ▲▼ to select [SCREEN POSITION].
 - [SCREEN POSITION] cannot be selected or adjusted when [SCREEN FORMAT] is set to [16:10].
- 5) Press ◀▶ to adjust [SCREEN POSITION].

[AUTO SIGNAL]

Set whether to execute automatic setup of signals automatically.

The screen display position or signal level can be adjusted automatically without pressing the <AUTO SETUP> button on the remote control on each occasion if you input unregistered signals frequently at meetings, etc.

- 1) Press ▲▼ to select [AUTO SIGNAL].
- 2) Press ◀▶ to switch the item.
 - The items will switch each time you press the button.

[OFF]	Sets the auto signal function to off.
[ON]	Executes automatic setup automatically when images are changed to unregistered signals during projection.

[AUTO SETUP]

Set this when adjusting a special signal or horizontally long (such as 16:9) signal.

Setting with [MODE]

- 1) Press ▲▼ to select [AUTO SETUP].
- 2) Press the <ENTER> button.
 - The [AUTO SETUP] screen is displayed.
- 3) Press ▲▼ to select [MODE].
- 4) Press ◀▶ to switch the item.
 - The items will switch each time you press the button.

[DEFAULT]	Standard setting.
[WIDE]	Select this item when an image aspect ratio is a wide-screen signal, which does not meet the [DEFAULT] setting.
[USER]	Select this when receiving a signal with a special horizontal resolution (number of display dots).

- Proceed to Step 7) when [DEFAULT] or [WIDE] is selected.
 - Proceed to Step 5) when [USER] is selected.
- 5) Press ▲▼ to select [DISPLAY DOTS], and press ◀▶ to match [DISPLAY DOTS] to the horizontal resolution of the signal source.
 - 6) Press ▲▼ to select [MODE].
 - 7) Press the <ENTER> button.
 - Automatic adjustment is executed. [PROGRESS] is displayed while in automatic adjustment. When completed, the screen returns to the [AUTO SETUP] screen.

Adjusting position automatically

- 1) Press ▲▼ to select [AUTO SETUP].
- 2) Press the <ENTER> button.
 - The [AUTO SETUP] screen is displayed.
- 3) Press ▲▼ to select [POSITION ADJUST].
- 4) Press ◀▶ to switch the item.

[ON]	Adjust the screen position and size when automatic setup is executed.
------	---

[OFF]	Does not perform automatic adjustment.
-------	--

Adjusting signal level automatically

- 1) Press ▲▼ to select [AUTO SETUP].
- 2) Press the <ENTER> button.
 - The [AUTO SETUP] screen is displayed.
- 3) Press ▲▼ to select [SIGNAL LEVEL ADJUST].
- 4) Press ◀▶ to switch the item.

[OFF]	Does not perform automatic adjustment.
[ON]	Adjusts black level (the [PICTURE] menu → [BRIGHTNESS]) and white level (the [PICTURE] menu → [CONTRAST]) when automatic setup is executed.

Note

- [SIGNAL LEVEL ADJUST] may not function properly unless a still image containing clear blacks and whites is input.

[COMPUTER IN/OUT]

Set the <COMPUTER 1 IN> terminal and the <COMPUTER 2 IN/1 OUT> terminal.

Setting [INPUT SETTING] in [COMPUTER IN/OUT] (COMPUTER1 input)

- 1) Press ▲▼ to select [COMPUTER IN/OUT].
- 2) Press the <ENTER> button.
 - The [COMPUTER IN/OUT] screen is displayed.
- 3) Press ▲▼ to select [INPUT SETTING].
- 4) Press ◀▶ to switch the item.
 - The items will switch each time you press the button.

[RGB/YP _B P _R]	Select this item when RGB signal or YC _B C _R /YP _B P _R signal is input to the <COMPUTER 1 IN> terminal.
[Y/C]	Select this item when a luminance signal and color signal are input to the <COMPUTER 1 IN> terminal.

Note

- Use the optional D-SUB - S Video conversion cable (Model No.: ET-ADSV) when the Y/C signal is input to the <COMPUTER 1 IN> terminal. For connection method, refer to "Connecting example: AV equipment" (▶ page 35).

Switching the slice level of an input synchronization signal

- 1) Press ▲▼ to select [COMPUTER IN/OUT].
- 2) Press the <ENTER> button.
 - The [COMPUTER IN/OUT] screen is displayed.
- 3) Press ▲▼ to select [SYNC SLICE LEVEL] of [COMPUTER1] or [COMPUTER2].
- 4) Press ◀▶ to switch the item.

[LOW]	Set the slice level to [LOW].
[HIGH]	Set the slice level to [HIGH].

Note

- [SYNC SLICE LEVEL] of [COMPUTER2] cannot be set when [COMPUTER2 SELECT] is set to [COMPUTER1 OUT].

Setting [EDID MODE] in [COMPUTER IN/OUT] (COMPUTER1 input/COMPUTER2 input)

- 1) Press ▲▼ to select [COMPUTER IN/OUT].
- 2) Press the <ENTER> button.
 - The [COMPUTER IN/OUT] screen is displayed.
- 3) Press ▲▼ to select [EDID MODE] of [COMPUTER1] or [COMPUTER2].
- 4) Press the <ENTER> button.
 - The [EDID MODE] screen is displayed.
- 5) Press ◀▶ to switch the item.
 - The items will switch each time you press the button.

[DEFAULT]	Standard setting.
[SCREEN FIT]	Changes the EDID data according to the [SCREEN FORMAT] setting.
[USER]	Sets the [RESOLUTION] and [VERTICAL SCAN FREQUENCY] items as EDID.

- Proceed to Step 10) when [DEFAULT] or [SCREEN FIT] is selected.

- 6) Press the <ENTER> button.
 - The [RESOLUTION] screen is displayed.
- 7) Press ▲▼◀▶ to select [RESOLUTION].
 - Select [1024x768p], [1280x720p], [1280x768p], [1280x800p], [1280x1024p], [1366x768p], [1400x1050p], [1440x900p], [1600x900p], [1600x1200p], [1680x1050p], [1920x1080p], [1920x1080i], or [1920x1200p].
- 8) Press the <ENTER> button.
 - The [VERTICAL SCAN FREQUENCY] screen is displayed.
- 9) Press ◀▶ to select [VERTICAL SCAN FREQUENCY].
 - Select [60Hz], [50Hz], [30Hz], [25Hz], or [24Hz] when [1920x1080p] is selected for [RESOLUTION].
 - Select [60Hz], [50Hz], or [48Hz] when [1920x1080i] is selected for [RESOLUTION].
 - Select [60Hz] or [50Hz] when anything other than following is selected for [RESOLUTION].
 - [1920x1080p], [1920x1080i]
- 10) Press the <ENTER> button.
 - The confirmation screen is displayed.
- 11) Press ◀▶ to select [OK], and press the <ENTER> button.

Note

- Settings in [RESOLUTION] and [VERTICAL SCAN FREQUENCY] are displayed in the [COMPUTER IN/OUT] screen.
- Setting of the resolution and the vertical scanning frequency may be necessary on the computer or video device in use.
- The computer, video device, or projector in use may require the power to be turned off and on again after setting.
- The output with the set resolution or vertical scanning frequency may not be possible depending on the computer or video device in use.
- [EDID MODE] in [COMPUTER2] cannot be set when [COMPUTER2 SELECT] is set to [COMPUTER1 OUT].

Setting [COMPUTER2 SELECT] in [COMPUTER IN/OUT] (COMPUTER2 input/COMPUTER1 output)

- 1) Press ▲▼ to select [COMPUTER IN/OUT].
- 2) Press the <ENTER> button.
 - The [COMPUTER IN/OUT] screen is displayed.
- 3) Press ▲▼ to select [COMPUTER2 SELECT].
- 4) Press ◀▶ to switch the item.
 - The items will switch each time you press the button.

[COMPUTER2 IN]	Select this item when using the <COMPUTER 2 IN/1 OUT> terminal as the COMPUTER2 input.
[COMPUTER1 OUT]	Select this item when the analog RGB signal or YC _B C _R /YP _B P _R signal input to the <COMPUTER 1 IN> terminal is output from the <COMPUTER 2 IN/1 OUT> terminal.

Note

- [COMPUTER2 SELECT] cannot be set when the COMPUTER2 input is selected.

[DVI-D IN]

Set this item in accordance with the video signal input to the <DVI-D IN> terminal.

Setting [SIGNAL LEVEL] in [DVI-D IN]

- 1) Press ▲▼ to select [DVI-D IN].
- 2) Press the <ENTER> button.
 - The [DVI-D IN] screen is displayed.
- 3) Press ▲▼ to select [SIGNAL LEVEL].
- 4) Press ◀▶ to switch the item.
 - The items will switch each time you press the button.

[AUTO]	Automatically sets the signal level.
[0-255:PC]	Select this item when the signal output from the DVI-D terminal of the external device (such as a computer) is input to the <DVI-D IN> terminal.
[16-235]	Select this item when the signal output from the HDMI terminal of the external device (such as a Blu-ray disc player) is input to the <DVI-D IN> terminal using a conversion cable, etc.

Note

- The optimal setting varies depending on the output setting of the connected external device. Refer to the operating instructions of the external device regarding the output of the external device.

Setting [EDID SELECT] in [DVI-D IN]

- 1) Press ▲▼ to select [DVI-D IN].
- 2) Press the <ENTER> button.
 - The [DVI-D IN] screen is displayed.
- 3) Press ▲▼ to select [EDID SELECT].
- 4) Press ◀▶ to switch the item.
 - The items will switch each time you press the button.

[EDID3]	Determines the moving image or still image signal automatically.
[EDID1]	Select this item mainly when an external device that will output the moving image signal (such as a Blu-ray disc player) is connected to the <DVI-D IN> terminal.
[EDID2:PC]	Select this item mainly when an external device that will output the still image signal (such as a computer) is connected to the <DVI-D IN> terminal.

Note

- The data for plug and play will change when the setting is changed. Refer to “List of compatible signals” (➔ page 167) for details on a resolution that supports plug and play.

Setting [EDID MODE] in [DVI-D IN]

- 1) Press ▲▼ to select [DVI-D IN].
- 2) Press the <ENTER> button.
 - The [DVI-D IN] screen is displayed.
- 3) Press ▲▼ to select [EDID MODE].
- 4) Press the <ENTER> button.
 - The [DVI-D] screen is displayed.

5) Press ◀▶ to switch the item.

- The items will switch each time you press the button.

[DEFAULT]	Standard setting.
[SCREEN FIT]	Changes the EDID data according to the [SCREEN FORMAT] setting.
[USER]	Sets the [RESOLUTION] and [VERTICAL SCAN FREQUENCY] items as EDID.

- Proceed to Step 10) when [DEFAULT] or [SCREEN FIT] is selected.

6) Press the <ENTER> button.

- The [RESOLUTION] screen is displayed.

7) Press ▲▼◀▶ to select [RESOLUTION].

- Select [1024x768p], [1280x720p], [1280x768p], [1280x800p], [1280x1024p], [1366x768p], [1400x1050p], [1440x900p], [1600x900p], [1600x1200p], [1680x1050p], [1920x1080p], [1920x1080i], or [1920x1200p].

8) Press the <ENTER> button.

- The [VERTICAL SCAN FREQUENCY] screen is displayed.

9) Press ◀▶ to select [VERTICAL SCAN FREQUENCY].

- Select [60Hz], [50Hz], [30Hz], [25Hz], or [24Hz] when [1920x1080p] is selected for [RESOLUTION].
- Select [60Hz], [50Hz], or [48Hz] when [1920x1080i] is selected for [RESOLUTION].
- Select [60Hz] or [50Hz] when anything other than following is selected for [RESOLUTION].
 - [1920x1080p], [1920x1080i]

10) Press the <ENTER> button.

- The confirmation screen is displayed.

11) Press ◀▶ to select [OK], and press the <ENTER> button.

Note

- Settings in [RESOLUTION] and [VERTICAL SCAN FREQUENCY] are displayed in the [DVI-D IN] screen.
- Setting of the resolution and the vertical scanning frequency may be necessary on the computer or video device in use.
- The computer, video device, or projector in use may require the power to be turned off and on again after setting.
- The output with the set resolution or vertical scanning frequency may not be possible depending on the computer or video device in use.

[HDMI IN]

Set this item in accordance with the video signal input to the <HDMI 1 IN> terminal or the <HDMI 2 IN> terminal.

Setting [SIGNAL LEVEL] in [HDMI IN]

1) Press ▲▼ to select [HDMI IN].

2) Press the <ENTER> button.

- The [HDMI IN] screen is displayed.

3) Press ▲▼ to select [SIGNAL LEVEL] of [HDMI1] or [HDMI2].

4) Press ◀▶ to switch the item.

- The items will switch each time you press the button.

[AUTO]	Automatically sets the signal level.
[64-940]	Select this item when the signal output from the HDMI terminal of the external device (such as a Blu-ray disc player) is input to the <HDMI 1 IN> terminal or the <HDMI 2 IN> terminal.
[0-1023]	Select this item when the signal output from the DVI-D terminal of the external device (such as a computer) is input to the <HDMI 1 IN> terminal or the <HDMI 2 IN> terminal using a conversion cable, etc. Select this item also when the signal output from the HDMI terminal of a computer, etc., is input to the <HDMI 1 IN> terminal or the <HDMI 2 IN> terminal.

Note

- The optimal setting varies depending on the output setting of the connected external device. Refer to the operating instructions of the external device regarding the output of the external device.
- The HDMI signal level is displayed for 30 bits of input.

Setting [EDID MODE] in [HDMI IN]

- 1) Press ▲▼ to select [HDMI IN].
- 2) Press the <ENTER> button.
 - The [HDMI IN] screen is displayed.
- 3) Press ▲▼ to select [EDID MODE] of [HDMI1] or [HDMI2].
- 4) Press the <ENTER> button.
 - The [HDMI1] screen or the [HDMI2] screen is displayed.
- 5) Press ◀▶ to switch the item.
 - The items will switch each time you press the button.

[DEFAULT]	Standard setting.
[SCREEN FIT]	Changes the EDID data according to the [SCREEN FORMAT] setting.
[USER]	Set the [RESOLUTION] and [VERTICAL SCAN FREQUENCY] items as EDID.

- Proceed to Step 10) when [DEFAULT] or [SCREEN FIT] is selected.

- 6) Press the <ENTER> button.
 - The [RESOLUTION] screen is displayed.
- 7) Press ▲▼◀▶ to select [RESOLUTION].
 - Select [1024x768p], [1280x720p], [1280x768p], [1280x800p], [1280x1024p], [1366x768p], [1400x1050p], [1440x900p], [1600x900p], [1600x1200p], [1680x1050p], [1920x1080p], [1920x1080i], or [1920x1200p].
- 8) Press the <ENTER> button.
 - The [VERTICAL SCAN FREQUENCY] screen is displayed.
- 9) Press ◀▶ to select [VERTICAL SCAN FREQUENCY].
 - Select [60Hz], [50Hz], [30Hz], [25Hz], or [24Hz] when [1920x1080p] is selected for [RESOLUTION].
 - Select [60Hz], [50Hz], or [48Hz] when [1920x1080i] is selected for [RESOLUTION].
 - Select [60Hz] or [50Hz] when anything other than following is selected for [RESOLUTION].
 - [1920x1080p], [1920x1080i]
- 10) Press the <ENTER> button.
 - The confirmation screen is displayed.
- 11) Press ◀▶ to select [OK], and press the <ENTER> button.

Note

- Settings in [RESOLUTION] and [VERTICAL SCAN FREQUENCY] are displayed in the [HDMI IN] screen.
- Setting of the resolution and the vertical scanning frequency may be necessary on the computer or video device in use.
- The computer, video device, or projector in use may require the power to be turned off and on again after setting.
- The output with the set resolution or vertical scanning frequency may not be possible depending on the computer or video device in use.

[DIGITAL LINK IN]

Set this item in accordance with the video signal input to the <DIGITAL LINK/LAN> terminal.

Setting [SIGNAL LEVEL] in [DIGITAL LINK IN]

- 1) Press ▲▼ to select [DIGITAL LINK IN].
- 2) Press the <ENTER> button.
 - The [DIGITAL LINK IN] screen is displayed.
- 3) Press ▲▼ to select [SIGNAL LEVEL].
- 4) Press ◀▶ to switch the item.
 - The items will switch each time you press the button.

[AUTO]	Automatically sets the signal level.
--------	--------------------------------------

[64-940]	Select this item when the signal output from the HDMI terminal of an external device (Blu-ray disc player, etc.) is input to the <DIGITAL LINK/LAN> terminal via a twisted-pair-cable transmitter.
[0-1023]	Select this item when the signal output from the DVI-D terminal or HDMI terminal of an external device (such as a computer) is input to the <DIGITAL LINK/LAN> terminal via a twisted-pair-cable transmitter.

Note

- The optimal setting varies depending on the output setting of the connected external device. Refer to the operating instructions of the external device regarding the output of the external device.
- The signal level is displayed for 30 bits of input.

Setting [EDID MODE] in [DIGITAL LINK IN]

- 1) Press ▲▼ to select [DIGITAL LINK IN].
- 2) Press the <ENTER> button.
 - The [DIGITAL LINK IN] screen is displayed.
- 3) Press ▲▼ to select [EDID MODE].
- 4) Press the <ENTER> button.
 - The [DIGITAL LINK] screen is displayed.
- 5) Press ◀▶ to switch the item.
 - The items will switch each time you press the button.

[DEFAULT]	Standard setting.
[SCREEN FIT]	Changes the EDID data according to the [SCREEN FORMAT] setting.
[USER]	Sets the [RESOLUTION] and [VERTICAL SCAN FREQUENCY] items as EDID.

- Proceed to Step 10) when [DEFAULT] or [SCREEN FIT] is selected.

- 6) Press the <ENTER> button.
 - The [RESOLUTION] screen is displayed.
- 7) Press ▲▼◀▶ to select [RESOLUTION].
 - Select [1024x768p], [1280x720p], [1280x768p], [1280x800p], [1280x1024p], [1366x768p], [1400x1050p], [1440x900p], [1600x900p], [1600x1200p], [1680x1050p], [1920x1080p], [1920x1080i], or [1920x1200p].
- 8) Press the <ENTER> button.
 - The [VERTICAL SCAN FREQUENCY] screen is displayed.
- 9) Press ◀▶ to switch [VERTICAL SCAN FREQUENCY].
 - Select [60Hz], [50Hz], [30Hz], [25Hz], or [24Hz] when [1920x1080p] is selected for [RESOLUTION].
 - Select [60Hz], [50Hz], or [48Hz] when [1920x1080i] is selected for [RESOLUTION].
 - Select [60Hz] or [50Hz] when anything other than following is selected for [RESOLUTION].
 - [1920x1080p], [1920x1080i]
- 10) Press the <ENTER> button.
 - The confirmation screen is displayed.
- 11) Press ◀▶ to select [OK], and press the <ENTER> button.

Note

- Settings in [RESOLUTION] and [VERTICAL SCAN FREQUENCY] are displayed in the [DIGITAL LINK IN] screen.
- Setting of the resolution and the vertical scanning frequency may be necessary on the computer or video device in use.
- The computer, video device, or projector in use may require the power to be turned off and on again after setting.
- The output with the set resolution or vertical scanning frequency may not be possible depending on the computer or video device in use.

[ON-SCREEN DISPLAY]

Set the on-screen display.

Setting [OSD POSITION]

Set the position of the menu screen (OSD).

- 1) Press ▲▼ to select [ON-SCREEN DISPLAY].
- 2) Press the <ENTER> button.
 - The [ON-SCREEN DISPLAY] screen is displayed.
- 3) Press ▲▼ to select [OSD POSITION].
- 4) Press ◀▶ to switch the item.
 - The items will switch each time you press the button.

[2]	Sets to the center left of the screen.
[3]	Sets to the bottom left of the screen.
[4]	Sets to the top center of the screen.
[5]	Sets to the center of the screen.
[6]	Sets to the bottom center of the screen.
[7]	Sets to the upper right of the screen.
[8]	Sets to the center right of the screen.
[9]	Sets to the bottom right of the screen.
[1]	Sets to the upper left of the screen.

Setting [OSD ROTATION]

Set the orientation of the menu screen (OSD).

- 1) Press ▲▼ to select [ON-SCREEN DISPLAY].
- 2) Press the <ENTER> button.
 - The [ON-SCREEN DISPLAY] screen is displayed.
- 3) Press ▲▼ to select [OSD ROTATION].
- 4) Press ◀▶ to switch the item.
 - The items will switch each time you press the button.

[OFF]	Does not rotate the screen.
[CLOCKWISE]	Rotates the screen by 90° clockwise.
[COUNTERCLOCKWISE]	Rotates the screen by 90° counterclockwise.

Setting [OSD DESIGN]

Set the color of the menu screen (OSD).

- 1) Press ▲▼ to select [ON-SCREEN DISPLAY].
- 2) Press the <ENTER> button.
 - The [ON-SCREEN DISPLAY] screen is displayed.
- 3) Press ▲▼ to select [OSD DESIGN].
- 4) Press ◀▶ to switch the item.
 - The items will switch each time you press the button.

[1]	Sets to yellow.
[2]	Sets to blue.
[3]	Sets to white.
[4]	Sets to green.
[5]	Sets to peach.
[6]	Sets to brown.

Setting [OSD MEMORY]

Set hold for the position of the menu screen (OSD) cursor.

- 1) Press ▲▼ to select [ON-SCREEN DISPLAY].

- 2) Press the <ENTER> button.
 - The [ON-SCREEN DISPLAY] screen is displayed.
- 3) Press ▲▼ to select [OSD MEMORY].
- 4) Press ◀▶ to switch the item.
 - The items will switch each time you press the button.

[ON]	Holds the cursor position.
[OFF]	Does not hold the cursor position.

Note

- Even if [ON] is set, the cursor position is not maintained when the power is turned off.

Setting [INPUT GUIDE]

Set whether to display the input guide in the position set in [OSD POSITION].

The input guide is the screen to display the information such as currently selected input terminal name, signal name, memory number, and the input terminal and signal structuring [P IN P].

- 1) Press ▲▼ to select [ON-SCREEN DISPLAY].
- 2) Press the <ENTER> button.
 - The [ON-SCREEN DISPLAY] screen is displayed.
- 3) Press ▲▼ to select [INPUT GUIDE].
- 4) Press ◀▶ to switch the item.
 - The items will switch each time you press the button.

[ON]	Displays the input guide.
[OFF]	Hides the input guide.

Setting [WARNING MESSAGE]

Set the display/hide of the warning message.

- 1) Press ▲▼ to select [ON-SCREEN DISPLAY].
- 2) Press the <ENTER> button.
 - The [ON-SCREEN DISPLAY] screen is displayed.
- 3) Press ▲▼ to select [WARNING MESSAGE].
- 4) Press ◀▶ to switch the item.
 - The items will switch each time you press the button.

[ON]	Displays the warning message.
[OFF]	Hides the warning message.

Note

- If [OFF] is set, the warning message will not be displayed on the projected image even when warning condition such as [TEMPERATURE WARNING] is detected while using the projector. Also, the following countdown message is not displayed: the message until the power is turned off after the no signal lights-out function is executed; the message until the light source is turned off after the no signal lights-out function is executed

[CLOSED CAPTION SETTING] (for NTSC or 480i YC_BC_R signal input only)

Set closed captions.

Selecting the closed caption display

- 1) Press ▲▼ to select [CLOSED CAPTION SETTING].

- 2) Press the <ENTER> button.
 - The [CLOSED CAPTION SETTING] screen is displayed.
- 3) Press ▲▼ to select [CLOSED CAPTION].
- 4) Press ◀▶ to switch the item.
 - The items will switch each time you press the button.

[OFF]	Hides closed captions.
[ON]	Displays closed captions.

- Proceed to Step 5) when [ON] is selected.
- 5) When the confirmation screen is displayed, press ◀▶ to select [OK], and press the <ENTER> button.

Setting the closed caption mode

- 1) Press ▲▼ to select [CLOSED CAPTION SETTING].
- 2) Press the <ENTER> button.
 - The [CLOSED CAPTION SETTING] screen is displayed.
- 3) Press ▲▼ to select [MODE].
 - [MODE] cannot be selected when [CLOSED CAPTION] is set to [OFF].
- 4) Press ◀▶ to switch the item.
 - The items will switch each time you press the button.

[CC1]	Displays CC1 data.
[CC2]	Displays CC2 data.
[CC3]	Displays CC3 data.
[CC4]	Displays CC4 data.

Note

- Closed caption is a function that displays text information of video signals mainly used in North America. Captions may not be displayed depending on the connected devices or contents being played back.
- [CLOSED CAPTION SETTING] can be selected only if NTSC or 480i YC_BC_R signal is input.
- If [CLOSED CAPTION] is set to [ON], brightness of images may change depending on the external devices compatible with closed caption function to be connected or contents to be used.
- If a closed caption signal of the selected mode is input, the security message set in the [SECURITY] menu → [DISPLAY SETTING] is not displayed.
- Closed captions are not displayed when the menu screen is displayed.

[BACK COLOR]

Set the display of the projected screen when there is no signal input.

- 1) Press ▲▼ to select [BACK COLOR].
- 2) Press ◀▶ to switch the item.
 - The items will switch each time you press the button.

[BLUE]	Displays the entire projection area in blue.
[BLACK]	Displays the entire projection area in black.
[DEFAULT LOGO]	Displays the Panasonic logo.
[USER LOGO]	Displays the image registered by the user.

Note

- To create/register the [USER LOGO] image, use "Logo Transfer Software" included in the supplied CD-ROM.

[STARTUP LOGO]

Set the logo display when the power is turned on.

- 1) Press ▲▼ to select [STARTUP LOGO].

2) Press ◀▶ to switch the item.

- The items will switch each time you press the button.

[DEFAULT LOGO]	Displays the Panasonic logo.
[USER LOGO]	Displays the image registered by the user.
[NONE]	Disables the startup logo display.

Note

- When [USER LOGO] is selected, the display of the startup logo will be kept for approximately 15 seconds.
- To create/register the [USER LOGO] image, use "Logo Transfer Software" included in the supplied CD-ROM.
- If the [PROJECTOR SETUP] menu → [ECO MANAGEMENT] → [QUICK STARTUP] is set to [ON], the startup logo is not displayed when projection starts before the specified time elapses after the projector enters the standby mode.
The specified time is a time set in the [PROJECTOR SETUP] menu → [ECO MANAGEMENT] → [QUICK STARTUP] → [VALID PERIOD].

[UNIFORMITY]

Correct the brightness and color unevenness of the entire screen.

Setting each color

- 1) Press ▲▼ to select [UNIFORMITY].
- 2) Press the <ENTER> button.
 - The [UNIFORMITY] screen is displayed.
- 3) Press ▲▼ to select [WHITE], [RED], [GREEN], or [BLUE].
- 4) Press ◀▶ to adjust the level.

Item	Operation	Adjustment	Range of adjustment
[VERTICAL]	Press ▶.	The lower-side color becomes pale, or the upper-side color becomes dark.	-127 - +127
	Press ◀.	The upper-side color becomes pale, or the lower-side color becomes dark.	
[HORIZONTAL]	Press ▶.	The left-side color becomes pale, or the right-side color becomes dark.	
	Press ◀.	The right-side color becomes pale, or the left-side color becomes dark.	

Setting [PC CORRECTION]

Set the [PC CORRECTION] function to correct the brightness and the color unevenness of the entire screen using a computer.

To use the [PC CORRECTION] function, an optional software application is required. Consult your dealer.

- 1) Press ▲▼ to select [UNIFORMITY].
- 2) Press the <ENTER> button.
 - The [UNIFORMITY] screen is displayed.
- 3) Press ▲▼ to select [PC CORRECTION].
- 4) Press ◀▶ to switch the item.

[OFF]	Does not perform correction using a computer.
[ON]*1	Performs correction for the brightness and color unevenness of the entire screen using a computer.

*1 Advanced skills are necessary to use computer control correction. Consult your dealer.

Note

- The setting value for [UNIFORMITY] will not return to factory default even if the [PROJECTOR SETUP] menu → [INITIALIZE] → [ALL USER DATA] is executed.

- In the following conditions, the setting of the [PICTURE] menu → [GAMMA] → [DEFAULT] is disabled and the same gamma mode as when [2.2] is set is applied.
 - When the levels of [WHITE], [RED], [GREEN], and [BLUE] are adjusted
 - When [PC CORRECTION] is set to [ON]
- If you need to switch the gamma mode to [1.8] or [2.0], first set the [PICTURE] menu → [GAMMA].

[SHUTTER SETTING]

Set the operation of the shutter function.

Setting [FADE-IN] or [FADE-OUT]

- 1) Press ▲▼ to select [SHUTTER SETTING].
- 2) Press the <ENTER> button.
 - The [SHUTTER SETTING] screen is displayed.
- 3) Press ▲▼ to select [FADE-IN] or [FADE-OUT].
- 4) Press ◀▶ to switch the item.

Item		Adjustment
[FADE-IN] [FADE-OUT]	[OFF]	Does not set fade-in or fade-out.
	[0.5s] - [10.0s]	Sets the fade-in or fade-out time. Select an item from [0.5s] - [4.0s], [5.0s], [7.0s], or [10.0s]. [0.5s] - [4.0s] can be selected in increments of 0.5.

Note

- If the <SHUTTER> button on the remote control is pressed during fade-in or fade-out, the fade operation is canceled.
- Fade-in/fade-out is not performed on the audio. Audio is output or paused linked to the operation of the shutter function.

Setting [STARTUP]

Automatically enable/disable the shutter function (shutter: closed/open) when the power is turned on.

- 1) Press ▲▼ to select [SHUTTER SETTING].
- 2) Press the <ENTER> button.
 - The [SHUTTER SETTING] screen is displayed.
- 3) Press ▲▼ to select [STARTUP].
- 4) Press ◀▶ to switch the item.

[OPEN]	The projector goes into projection mode with the shutter function disabled (shutter: opened) when the power is turned on.
[CLOSE]	The projector goes into projection mode with the shutter function enabled (shutter: closed) when the power is turned on.

Using the shutter function

Image and audio is turned off when the projector is not used for a specific time.

- 1) Press ▲▼ to select [SHUTTER SETTING].
- 2) Press the <ENTER> button.
 - The [SHUTTER SETTING] screen is displayed.
- 3) Press ▲▼ to select [SHUTTER].
- 4) Press the <ENTER> button.
 - Press the <MENU> button to cancel the function.

Note

- The power indicator <ON (G)/STANDBY (R)> will blink slowly in green while the shutter function is in use (shutter: closed).
- To output audio while the shutter function is in use (shutter: closed), set the [PROJECTOR SETUP] menu → [AUDIO SETTING] → [IN SHUTTER] to [ON].

[FREEZE]

The projected image is paused and audio is turned off regardless of the playback of the external device.

- 1) Press ▲▼ to select [FREEZE].
- 2) Press the <ENTER> button.
 - Press the <MENU> button to release.

Note

- [FREEZE] is displayed on the screen when video is paused.

[WAVEFORM MONITOR]

Use the input signals from a connected external device to display in a waveform. Check whether video output (luminance) signal level is within the recommended range for the projector and adjust.

- 1) Press ▲▼ to select [WAVEFORM MONITOR].
- 2) Press ◀▶ to switch the item.

[OFF]	Does not display the waveform monitor.
[ON]	Displays the waveform monitor.

- 3) Press the <MENU> button two times to clear.
- 4) Press ▲▼ to select any horizontal line.
- 5) Press the <ENTER> button to switch the Select line to either luminance, red, green, or blue.
 - Line selection items switch each time the <ENTER> is pressed only when the waveform monitor is displayed.

“Select line (luminance)”	Displayed in white waveform.
“Select line (red)”	Displayed in red waveform.
“Select line (green)”	Displayed in green waveform.
“Select line (blue)”	Displayed in blue waveform.

Note

- Setting is also available from the [PROJECTOR SETUP] menu → [FUNCTION BUTTON].
- The waveform monitor cannot be displayed while in the P IN P mode.
- The waveform monitor turns off when the P IN P function is used while the waveform is being monitored.
- The waveform monitor is not displayed when on-screen display is hidden (off).

Adjusting the waveform

Project the luminance adjustment signal of a commercial test disk (0 % (0 IRE or 7.5 IRE) – 100 % (100 IRE)) and adjust.

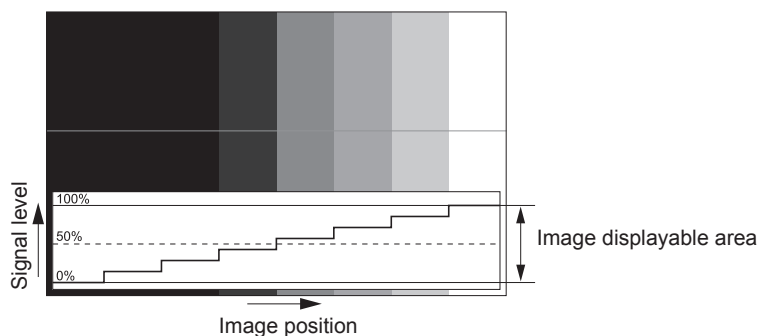

- 1) Select “Select line (luminance)” on the waveform monitor.
- 2) Adjust black level.
 - Adjust the black level 0 % of the video signal to the 0 % position of the waveform monitor using the [PICTURE] menu → [BRIGHTNESS].

3) Adjust white level.

- Adjust the white level 100 % of the video signal to the 100 % position of the waveform monitor using the [PICTURE] menu → [CONTRAST].

Adjusting red, green, and blue

1) Set [COLOR TEMPERATURE] to [USER]. (→ page 63)

2) Select “Select line (red)” on the waveform monitor.

3) Adjust dark red areas.

- Use [RED] in [WHITE BALANCE LOW] to adjust the black level 0 % of the video signal to the 0 % position of the waveform monitor.

4) Adjust bright red areas.

- Use [RED] in [WHITE BALANCE HIGH] to adjust the white level 100 % of the video signal to the 100 % position of the waveform monitor.

5) Use the procedure for [RED] to adjust [GREEN] and [BLUE].

Note

- Confirm that the [SIGNAL LEVEL] setting of the input signal is correct before adjusting the black level. Check the [SIGNAL LEVEL] setting from the [DISPLAY OPTION] menu → [DVI-D IN]/[HDMI IN]/[DIGITAL LINK IN] → [SIGNAL LEVEL].

[CUT OFF]

Each red, green, and blue color component can be removed.

1) Press ▲▼ to select [CUT OFF].

2) Press the <ENTER> button.

- The [CUT OFF] screen is displayed.

3) Press ▲▼ to select [RED], [GREEN], or [BLUE].

4) Press ◀▶ to switch the item.

[OFF]	Disables cutoff.
[ON]	Enables cutoff.

Note

- When input is switched or a signal is switched, the cutoff setting returns to its original setting (off).

[PROJECTOR SETUP] menu

On the menu screen, select [PROJECTOR SETUP] from the main menu, and select an item from the sub-menu.

Refer to “Navigating through the menu” (➔ page 57) for the operation of the menu screen.

[PROJECTOR ID]

The projector has an ID number setting function that can be used when multiple projectors are used side by side to enable simultaneous control or individual control via a single remote control.

- 1) Press ▲▼ to select [PROJECTOR ID].
- 2) Press ◀▶ to switch the item.
 - The items will switch each time you press the button.

[ALL]	Select this item when controlling projectors without specifying an ID number.
[1] - [64]	Select this item when specifying an ID number to control individual projector.

Note

- To specify an ID number for individual control, the ID number of a remote control must match the ID number of the projector.
- When the ID number is set to [ALL], the projector will operate regardless of the ID number specified during remote control or computer control.
If multiple projectors are set up side by side with IDs set to [ALL], they cannot be controlled separately from the projectors with other ID numbers.
- Refer to “Setting ID number of the remote control” (➔ page 54) for how to set the ID number on the remote control.

[PROJECTION METHOD]

Set the projection method in accordance with the installation status of the projector.

Change the [FRONT/REAR] setting when the screen display is inverted.

Change the [FLOOR/CEILING] setting when the screen display is upside down.

Setting [FRONT/REAR]

- 1) Press ▲▼ to select [FRONT/REAR] of [PROJECTION METHOD].
- 2) Press ◀▶ to switch the item.
 - The items will switch each time you press the button.

[FRONT]	Select this item when installing the projector in front of the screen.
[REAR]	Select this item when installing behind the screen (using translucent screen).

Setting [FLOOR/CEILING]

- 1) Press ▲▼ to select [FLOOR/CEILING] of [PROJECTION METHOD].
- 2) Press ◀▶ to switch the item.
 - The items will switch each time you press the button.

[AUTO]	Automatically detects the attitude of the projector by the built-in angle sensor. Set [AUTO] normally.
[FLOOR]	Select this item when installing the projector on a desk, etc.
[CEILING]	Select this item when installing the projector using the Ceiling Mount Bracket (optional). Projected image is inverted upside down.

Note

- Refer to “Angle sensor” (➔ page 31) for details on the range of the installation attitude that can be detected by the built-in angle sensor.

[ECO MANAGEMENT]

Set the operation method of the projector.

Setting [OPERATING MODE]

- 1) Press ▲▼ to select [ECO MANAGEMENT].
- 2) Press the <ENTER> button.
 - The [ECO MANAGEMENT] screen is displayed.
- 3) Press ▲▼ to select [OPERATING MODE].
- 4) Press ◀▶ to switch the item.
 - The items will switch each time you press the button.

[NORMAL]	Set this item when high luminance is required. [LIGHT OUTPUT] is 100 %, and the estimated runtime is approximately 20 000 hours.
[ECO]	Set this item to increase the life of the light source, though it will lower the luminance than [NORMAL]. [LIGHT OUTPUT] is 80 %, and the estimated runtime is approximately 24 000 hours.
[SILENT]	Select this item when operation with lower noise is preferred. [LIGHT OUTPUT] is 80 %, and the estimated runtime is approximately 20 000 hours.
[USER]	[LIGHT OUTPUT] can be set individually.

- Proceed to Step 5) when [USER] is selected.

- 5) Press ▲▼ to select [LIGHT OUTPUT].
- 6) Press ◀▶ to adjust.

Operation	Adjustment		Range of adjustment
	Brightness	Runtime (estimate)	
Press ▶.	The screen becomes brighter.	The runtime becomes shorter.	20 % - 100 %
Press ◀.	The screen becomes darker.	The runtime becomes longer.	

Note

- When [USER] is selected, the uniformity of brightness between multiple screens can be maintained by adjusting [LIGHT OUTPUT] of each projector when a multi-display screen is structure with multiple projectors.
- If the runtime exceeds 20 000 hours, replacement of the components inside the projector may be required. Consult your dealer for details.

Interrelation of luminance and runtime

When [OPERATING MODE] is set to [USER], the relationship between the luminance and the runtime is as follows. Make the settings depending on your desired duration of use and brightness of the projected image. Values of the luminance and runtime are rough estimations.

[LIGHT OUTPUT] (%)	Luminance (lm)	Runtime (hour)
100	5 200	20 000
80	4 100	22 700
60	3 100	24 800
40	2 000	26 400
20	1 000	27 400

Note

- Under influences of characteristics of each light source, conditions of use, installation environment, etc., the runtime may be shorter than the estimation.
- Runtime is a time until the luminance of the light source to become about half when using the projector continuously. The runtime is just an estimate, and is not the warranty period.
- If the runtime exceeds 20 000 hours, replacement of the components inside the projector may be required. Consult your dealer for details.

Setting [AUTO POWER SAVE]

Enable/disable the [AMBIENT LIGHT DETECTION] and [NO SIGNAL LIGHTS-OUT] functions.

- 1) Press ▲▼ to select [ECO MANAGEMENT].

- 2) Press the <ENTER> button.
 - The [ECO MANAGEMENT] screen is displayed.
- 3) Press ▲▼ to select [AUTO POWER SAVE].
- 4) Press ◀▶ to switch the item.
 - The items will switch each time you press the button.

[OFF]	Disables the auto power save setting.
[ON]	Enables the auto power save setting.

- 5) Press ▲▼ to select [AMBIENT LIGHT DETECTION] or [NO SIGNAL LIGHTS-OUT].

[AMBIENT LIGHT DETECTION]	Adjusts the power of the light source in accordance with the brightness of the installed location.
[NO SIGNAL LIGHTS-OUT]	Automatically turns off the light source of the projector when there is no input signal for specific period.

- 6) Press ◀▶ to switch the item.
 - The items will switch each time you press the button.

[AMBIENT LIGHT DETECTION]	[OFF]	Disables the ambient light detection function.
	[ON]	Enables the ambient light detection function.
[NO SIGNAL LIGHTS-OUT]	[DISABLE]	Disables the no signal lights-out function.
	[10SEC.] - [5MIN.]	Turns off the light source when there is no input signal for the preset period. Select [10SEC.], [20SEC.], [30SEC.], [1MIN.], [2MIN.], [3MIN.], or [5MIN.].

Note

- [AMBIENT LIGHT DETECTION] and [NO SIGNAL LIGHTS-OUT] cannot be set when [AUTO POWER SAVE] is set to [OFF].
- The power indicator <ON (G)/STANDBY (R)> will blink slowly in green while the no signal lights-out function is operating and the light source is turned off.
- When [NO SIGNAL LIGHTS-OUT] is set to anything other than [DISABLE], the conditions to turn on the light source again from the condition that the light source was turned off by this function are as follows.
 - When the signal has been input
 - When on-screen display such as menu screen (OSD) or input guide, a test pattern, or a warning message is displayed
 - When the power <⏻/⏪> button is pressed
 - When the operation to disable the shutter function (shutter: open) is performed, such as pressing the <SHUTTER> button
 - When the operating environment temperature is around 0 °C (32 °F) and the light source is forced to turn on due to warm-up
- The luminance may not be detected correctly when an object is placed on top of the projector, blocking the luminance sensor. In such a case, it may not operate properly even if [AMBIENT LIGHT DETECTION] is set to [ON].

Setting [NO SIGNAL SHUT-OFF]

This is a function to automatically set the power of the projector to standby mode when there is no input signal for specific period. The time before switching to standby can be set.

- 1) Press ▲▼ to select [ECO MANAGEMENT].
- 2) Press the <ENTER> button.
 - The [ECO MANAGEMENT] screen is displayed.
- 3) Press ▲▼ to select [NO SIGNAL SHUT-OFF].
- 4) Press ◀▶ to switch the item.
 - The items will switch each time you press the button.

[DISABLE]	Disables the no signal shut-off function.
[10MIN.] - [90MIN.]	Sets the time in increments of 10 minutes.

Setting [STANDBY MODE]

Set the power consumption during standby and whether to enable the [QUICK STARTUP] function.

- 1) Press ▲▼ to select [ECO MANAGEMENT].

- 2) Press the <ENTER> button.
 - The [ECO MANAGEMENT] screen is displayed.
- 3) Press ▲▼ to select [STANDBY MODE].
- 4) Press ◀▶ to switch the item.
 - The items will switch each time you press the button.

[NORMAL]	Select this item when using the network function during standby.
[ECO]	Select this item to reduce power consumption during standby.

- Proceed to Step 5) when [NORMAL] is selected.

- 5) Press ▲▼ to select [QUICK STARTUP].
- 6) Press ◀▶ to switch the item.
 - The items will switch each time you press the button.

[OFF]	Disables the [QUICK STARTUP] function.
[ON]	Enables the [QUICK STARTUP] function until the specified time set in [VALID PERIOD] elapses after the projector enters the standby mode. The time until the projection starts after the power is turned on will be reduced during the period when the [QUICK STARTUP] function is valid.

- Proceed to Step 7) when [ON] is selected.

- 7) Press the <ENTER> button.
 - The [QUICK STARTUP] screen is displayed.
- 8) Press ◀▶ to switch [VALID PERIOD].
 - The items will switch each time you press the button.

[30MIN.]	Sets the time until the [QUICK STARTUP] function is disabled after the projector enters the standby mode.
[60MIN.]	
[90MIN.]	Select a desired valid period.

Note

- When [STANDBY MODE] is set to [NORMAL], the network function can be used during standby.
- When [STANDBY MODE] is set to [ECO], the network function and the audio output function cannot be used during standby. Also, some RS-232C commands cannot be used.
- When [STANDBY MODE] is set to [ECO], it takes longer for the projection to start after the power is turned on, compared to when set to [NORMAL].
- [STANDBY MODE] is fixed to [NORMAL] when the [PROJECTOR SETUP] menu → [SCHEDULE] is set to [ON].
- [QUICK STARTUP] cannot be set when [STANDBY MODE] is set to [ECO].
- When [QUICK STARTUP] is set to [ON], the power consumption during standby becomes high during the period when the [QUICK STARTUP] function is valid.
- If [QUICK STARTUP] is set to [ON], the [QUICK STARTUP] function is disabled when the time set in [VALID PERIOD] elapses after the projector enters the standby mode. The startup time and power consumption will be the same as when [QUICK STARTUP] is set to [OFF].
- When [QUICK STARTUP] is set to [ON], the power indicator <ON (G)/STANDBY (R)> blinks in red while in the standby mode during the period when the [QUICK STARTUP] function is valid. When [IN STANDBY MODE] in [AUDIO SETTING] is set to [OFF], the power indicator <ON (G)/STANDBY (R)> will change to a red light when the specified time set in [VALID PERIOD] elapses after the projector enters the standby mode.
- When [QUICK STARTUP] is set to [ON], the period when the [QUICK STARTUP] function is valid will be added as the projector runtime.

[BRIGHTNESS CONTROL]

The projector is equipped with a brightness sensor to measure brightness and color of the light source, and corrects brightness and white balance of the projected image according to the changes in brightness and color of the light source.

By using this function while structuring the multi-display by combining the projected images from multiple projectors, the change in the brightness and white balance for the whole multi-display can be reduced or hold down the difference of the brightness and white balance to maintain uniformity, caused by the aging of the light source.

Setting [BRIGHTNESS CONTROL GAIN]

Adjust the brightness when displaying multiple images using multiple projectors.

- 1) Press ▲▼ to select [BRIGHTNESS CONTROL].
- 2) Press the <ENTER> button.
 - The [BRIGHTNESS CONTROL] screen is displayed.
- 3) Press ▲▼ to select [BRIGHTNESS CONTROL GAIN].
- 4) Press ◀▶ to adjust.

Operation	Adjustment		Range of adjustment
	Brightness	Runtime (estimate)	
Press ▶.	The screen becomes brighter.	Maximum correction will decrease.	20 % - 100 %
Press ◀.	The screen becomes darker.	Maximum correction will increase.	

Note

- When using only one projector, the value obtained by subtracting the value of the [BRIGHTNESS CONTROL GAIN] from 100 % is the maximum amount of brightness correction. Brightness cannot be corrected through brightness control since the maximum amount of correction becomes 0 % when [BRIGHTNESS CONTROL GAIN] is at 100 %.
- The luminance will not stabilize for eight minutes after turning on the light source. Perform the adjustment after at least eight minutes have elapsed after starting the projection.
- The adjustment result of [BRIGHTNESS CONTROL GAIN] is reflected in all of the video signal, internal test patterns, and on-screen menu.
- The [BRIGHTNESS CONTROL GAIN] setting is valid even when [CONSTANT MODE] in [BRIGHTNESS CONTROL SETUP] is set to [OFF].

Setting [BRIGHTNESS CONTROL SETUP]

Set the operation of the brightness control function.

- 1) Press ▲▼ to select [BRIGHTNESS CONTROL].
- 2) Press the <ENTER> button.
 - The [BRIGHTNESS CONTROL] screen is displayed.
- 3) Press ▲▼ to select [BRIGHTNESS CONTROL SETUP].
- 4) Press the <ENTER> button.
 - The [BRIGHTNESS CONTROL SETUP] screen is displayed.
- 5) Press ▲▼ to select [CONSTANT MODE].
- 6) Press ◀▶ to switch the item.
 - The items will switch each time you press the button.

[OFF]	Does not correct the brightness of the screen by the brightness sensor.
[AUTO]	Corrects the brightness of the screen by the brightness sensor. When the brightness of light source or white balance changes, the brightness of the projected image is automatically corrected.
[PC]	Synchronizes nine or more projectors using a computer and the dedicated software "Multi Monitoring & Control Software"*1.

*1 "Multi Monitoring & Control Software" is included in the supplied CD-ROM.

- When [PC] is selected, proceed to Step 9).

7) Press ▲▼ to select [LINK].

8) Press ◀▶ to switch the item.

- The items will switch each time you press the button.

[OFF]	Performs corrections by the brightness sensor on a single projector without synchronizing with the other projectors. The duration that the constant brightness is kept will become longer by setting the value of [LIGHT OUTPUT] smaller.
[GROUP A] [GROUP B] [GROUP C] [GROUP D]	Performs correction by the brightness sensor in multiple projectors in synchronization. Up to four groups (A to D) can be set within the same subnet by using the network function. You can register and synchronize up to eight projectors in one group.

9) Press ▲▼ to select [CALIBRATION TIME].

10) Press the <ENTER> button.

- The projector is in the adjustment mode (the time is blinking).

11) Press ◀▶ to select “hour” or “minute”, and press ▲▼ or the number (<0> - <9>) buttons to set a time.

- Selecting “hour” allows setting of only the hour in increments of one hour, and selecting “minute” allows setting of only the minute in increments of one minute between 00 and 59.
- When the time is not specified, select [OFF] between 23 and 00 of the hour, or between 59 and 00 of the minute.

12) Press the <ENTER> button.

- [CALIBRATION TIME] is set.
- Brightness and color are measured at the specified time. The dynamic contrast function does not operate during measurement.

13) Press ▲▼ to select [CALIBRATION MESSAGE].

14) Press ◀▶ to switch the item.

- The items will switch each time you press the button.

[ON]	Displays messages during calibration.
[OFF]	Does not display messages during calibration.

15) Press ▲▼ to select [APPLY].

16) Press the <ENTER> button.

- If the <ENTER> button is pressed with [CONSTANT MODE] set to anything other than [OFF], the brightness and white balance of light source at the time when the button is pressed is recorded as the standard brightness and white balance.
- If the <ENTER> button is pressed when [LINK] is set from [GROUP A] to [GROUP D], the group name is displayed on the screens of projectors that have been set in the same group.



Note

- When [CONSTANT MODE] is set to [AUTO] or [PC], keep the shutter function disabled (shutter: open) for at least 30 seconds to perform the brightness sensor calibration after the [BRIGHTNESS CONTROL SETUP] setting has been completed.
- If the projector is operating with [CONSTANT MODE] set to [AUTO] or [PC], brightness and color cannot be measured when the shutter function is enabled (shutter: closed) within approximately eight minutes after the light source is turned on. Therefore, brightness may be corrected after approximately 30 seconds have elapsed after the shutter function is disabled (shutter: open).
- If the projector is operating with [CONSTANT MODE] set to [AUTO] or [PC], the brightness and color of the light source do not stabilize for approximately eight minutes after the light source is turned on. Therefore, the brightness and color of the light source will be automatically measured after approximately eight minutes have elapsed after the light source is turned on. A correction is made based on this measurement result so that the brightness and color for the image will be the same as the standard brightness and color when adjusted with the brightness control.
- If the projector is operating with [CONSTANT MODE] set to [AUTO] or [PC], the items of [OPERATING MODE] and [LIGHT OUTPUT] cannot be changed.
- The variation in brightness may increase due to dust accumulating on the lens, screen, or inside the projector, depending on the installation environment of the projector.

- When the variation in brightness has increased due to aging of the light source, or when you replaced the light source, readjust the brightness control.
- When the projector is used continuously for more than 24 hours, set [CALIBRATION TIME]. If it is not set, correction will not be performed automatically.
- The brightness control function and the dynamic contrast function will operate simultaneously, but the dynamic contrast function will not operate while measuring the brightness and the color.
- The [CALIBRATION TIME] setting will be reflected when you enter the time.
- The [CALIBRATION MESSAGE] setting will be reflected at the time when the item is switched using ◀▶.

Displaying [BRIGHTNESS CONTROL STATUS]

Display the brightness control status.

- 1) Press ▲▼ to select [BRIGHTNESS CONTROL].
- 2) Press the <ENTER> button.
 - The [BRIGHTNESS CONTROL] screen is displayed.
- 3) Press ▲▼ to select [BRIGHTNESS CONTROL STATUS].
- 4) Press the <ENTER> button.
 - The [BRIGHTNESS CONTROL STATUS] screen is displayed.

[BRIGHTNESS CONTROL STATUS] screen display example

When [CONSTANT MODE] is set to [OFF]

The screen shows the status that the brightness control is disabled.

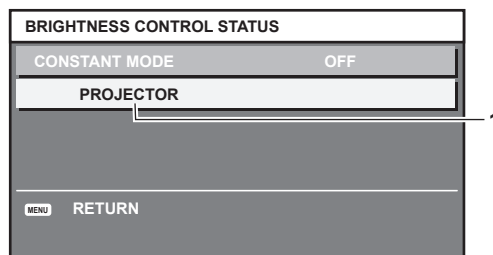

When [CONSTANT MODE] is set to [AUTO], and [LINK] is set to [OFF]

The screen shows the status of the brightness control in one projector.

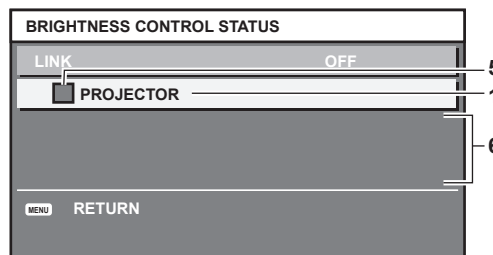

When [CONSTANT MODE] is set to [AUTO], and [LINK] is set to [GROUP A] through [GROUP D]

The screen shows the status of the brightness control of synchronized projectors (up to eight units), including the projector being controlled through the on-screen menu.

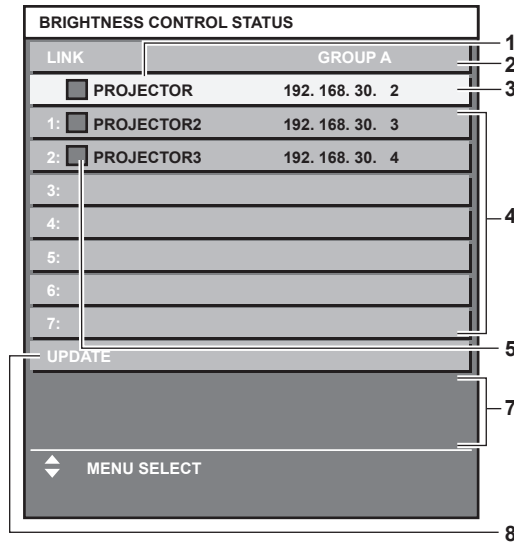

When [CONSTANT MODE] is set to [PC]

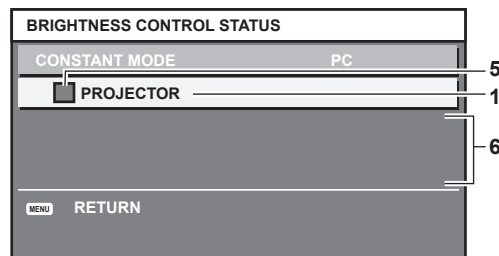

- 1 Display the name of the projector.
- 2 Display the synchronized group.
- 3 Display the IP address of the projector.
- 4 Display the names and IP addresses of projectors in same group detected over the network.
- 5 Display the status by color.
Green: There is an allowance for brightness correction.
Yellow: There is little allowance for brightness correction.
Red: There is a brightness control error.
- 6 Display error detailed messages.
- 7 Display error messages.
When the message [Failed to apply BRIGHTNESS CONTROL to some projectors.] appears, it means that synchronization with the projector displayed in red has failed.
Press ▲▼ to select the projector displayed in red, and press the <ENTER> button to display the error details.
- 8 Update to the latest status information.

■ Error details

Error message	Measures to take
[Exceed maximum number of projectors.]	<ul style="list-style-type: none"> • Limit the number of projectors in one group to eight. • To synchronize nine or more projectors, use a PC and the dedicated software “Multi Monitoring & Control Software”^{*1}.
[Please check the COMMAND CONTROL setting.]	<ul style="list-style-type: none"> • Set [NETWORK CONTROL] → [COMMAND CONTROL] to [ON] for the projector in error. • Set [NETWORK CONTROL] → [COMMAND PORT] of all projectors to be linked to the same value.
[Please check the USER NAME and PASSWORD in the COMMAND CONTROL setting.]	<ul style="list-style-type: none"> • Assign the same [User name] and [Password] strings that have web control administrator rights to all projectors to be linked.
[Cannot apply BRIGHTNESS CONTROL. Please check projector status.]	<ul style="list-style-type: none"> • The projector is in standby. Switch on the power.
[Brightness Sensor Error]	<ul style="list-style-type: none"> • There is a problem with the brightness sensor. If problems persist even after switching on the power, consult your dealer.

*1 “Multi Monitoring & Control Software” is included in the supplied CD-ROM.

Note

- If the synchronized projectors are not displayed in the list, check the following:
 - Are there devices with the same IP address on the network?
 - Are LAN cables connected correctly? (➔ page 127)
 - Are the subnets of the projectors the same?
 - Are the same [LINK] settings applied to a group?
- Refer to [NETWORK SETUP] (➔ page 123) or “[Network config] page” (➔ page 137) on how to change the projector name.

Brightness control adjustment procedure example

The steps exemplify an adjustment to link the brightness of eight projectors connected in a network.

- 1) **Connect all projectors to the hub using LAN cables.** (➔ page 127)
- 2) **Switch on all projectors and start projection.**
- 3) **Set [CONSTANT MODE] of [BRIGHTNESS CONTROL SETUP] to [OFF], and select [APPLY], and then press the <ENTER> button.**
- 4) **Set [OPERATING MODE] of each projector to the same setting.** (➔ page 96)
- 5) **Set [SUBNET MASK] and [IP ADDRESS] in each projector.**
 - To be able to communicate over the network, set the same value in [SUBNET MASK] for all projectors and set a different value in [IP ADDRESS] for each projector.
- 6) **Wait for at least eight minutes after projection has started until the light source brightness becomes steady.**
- 7) **Set all items in the [PICTURE] menu of all projectors to the same values.**
- 8) **Adjust [COLOR MATCHING] to match colors.**
- 9) **Display the internal test pattern “All white” in all projectors.**
- 10) **Set [BRIGHTNESS CONTROL GAIN] of all the projectors to 100 %.**
- 11) **Set [BRIGHTNESS CONTROL GAIN] of the projector with the least brightness to 90 %.**
- 12) **Adjust [BRIGHTNESS CONTROL GAIN] of each projector.**
 - Adjust [BRIGHTNESS CONTROL GAIN] of all the other projectors so that the brightness will be the same as the projector with the least brightness.
- 13) **Set [CONSTANT MODE] of [BRIGHTNESS CONTROL SETUP] to [AUTO], and [LINK] to [GROUP A] in all projectors.**
- 14) **Select [APPLY] of [BRIGHTNESS CONTROL SETUP] and press the <ENTER> button in all projectors.**
 - Brightness control starts.

Note

- Brightness is automatically corrected whenever the light source lights up by switching on/off the projector, etc.
- When the variation in brightness has increased due to aging of the light source, or when you replaced the light source, readjust the brightness control.

[SCHEDULE]

Set the command execution schedule for each day of the week.

Enabling/disabling the schedule function

- 1) **Press ▲▼ to select [SCHEDULE].**
- 2) **Press ◀▶ to switch the item.**
 - The items will switch each time you press the button.

[OFF]	Disables the schedule function.
[ON]	Enables the schedule function. Refer to “How to assign a program” (➔ page 104) or “How to set a program” (➔ page 104) for how to set the schedule.

Note

- The [STANDBY MODE] setting will be forced to [NORMAL] when the [PROJECTOR SETUP] menu → [ECO MANAGEMENT] → [STANDBY MODE] is set to [ECO], and [SCHEDULE] is set to [ON]. Changing the setting to [ECO] is not available. The [STANDBY MODE] setting will not change back even when [SCHEDULE] is set to [OFF] in this condition.

How to assign a program

- 1) Press ▲▼ to select [SCHEDULE].
- 2) Press ◀▶ to select [ON], and press the <ENTER> button.
 - The [SCHEDULE] screen is displayed.
- 3) Select and assign a program to each day of week.
 - Press ▲▼ to select the day of week, and press ◀▶ to select a program number.
 - You can set the program from No.1 to No.7. “- - -” indicates that the program number has not been set.

How to set a program

Set up to 16 commands to each program.

- 1) Press ▲▼ to select [SCHEDULE].
- 2) Press ◀▶ to select [ON], and press the <ENTER> button.
 - The [SCHEDULE] screen is displayed.
- 3) Press ▲▼ to select [PROGRAM EDIT].
- 4) Press ◀▶ to select a program number, and press the <ENTER> button.
- 5) Press ▲▼ to select a command number, and press the <ENTER> button.
 - You can change the page using ◀▶.
- 6) Press ▲▼◀▶ to select [TIME], and press the <ENTER> button.
 - The projector is in the adjustment mode (the time is blinking).
- 7) Press ◀▶ to select “hour” or “minute”, and press ▲▼ or the number (<0> - <9>) buttons to set a time, and then press the <ENTER> button.
- 8) Press ▲▼◀▶ to select [COMMAND].
- 9) Press the <ENTER> button.
 - The [COMMAND] detailed screen is displayed.
- 10) Press ▲▼ to select a [COMMAND].
 - For [COMMAND] which requires detailed settings, the items of the detailed settings will switch each time you press ◀▶.
 - When [INPUT] is selected, press the <ENTER> button, and then press ▲▼◀▶ to select the input to be set.

[COMMAND]	Detailed settings of [COMMAND]	Description
[POWER ON]	—	Switches on the projector.
[STANDBY]	—	Enters standby.
[QUICK STARTUP]	[ON]	Enables the function of the [PROJECTOR SETUP] menu → [ECO MANAGEMENT] → [QUICK STARTUP].
	[OFF]	Disables the function of the [PROJECTOR SETUP] menu → [ECO MANAGEMENT] → [QUICK STARTUP].
[SHUTTER]	[OPEN]	Disables the shutter function (shutter: open).
	[CLOSE]	Enables the shutter function (shutter: closed).

[COMMAND]	Detailed settings of [COMMAND]	Description
[INPUT]	[COMPUTER1]	Switches the input to COMPUTER1.
	[COMPUTER2]* ¹	Switches the input to COMPUTER2.
	[VIDEO]	Switches the input to VIDEO.
	[DVI-D]	Switches the input to DVI-D.
	[HDMI1]	Switches the input to HDMI1.
	[HDMI2]	Switches the input to HDMI2.
	[DIGITAL LINK]	Switches the input to DIGITAL LINK.
	[INPUT1] - [INPUT10]* ²	Switches the input to DIGITAL LINK, and switches the input of the Panasonic twisted-pair-cable transmitter to the specified input.
[OPERATING MODE]	[NORMAL]	Prioritizes luminance.
	[ECO]	Controls the power to increase the life of the light source although the luminance is lower than that of [NORMAL].
	[SILENT]	Prioritizes the operation with less noise although the luminance is lower than that of [NORMAL].
	[USER]	Controls the power with the setting set in [USER].
[P IN P]	[OFF]	P IN P function is not used.
	[USER1]	Places the sub screen with the setting set in [USER1].
	[USER2]	Places the sub screen with the setting set in [USER2].
	[USER3]	Places the sub screen with the setting set in [USER3].
[IN STANDBY MODE(AUDIO)]	[OFF]	Stops the audio output during standby.
	[ON]	Outputs the audio during standby.
[VOLUME]	[0] - [63]	Sets the volume.

*1 The [COMPUTER2] command is disabled when the [DISPLAY OPTION] menu → [COMPUTER IN/OUT] → [COMPUTER2 SELECT] is set to [COMPUTER1 OUT].

*2 When the optional DIGITAL LINK output supported device (Model No.: ET-YFB100G, ET-YFB200G) is connected to the projector, its input name is automatically reflected from [INPUT1] to [INPUT10]. When an item that does not reflect the input name is selected, it will be disabled.

11) Press the <ENTER> button.

- The command is fixed and ● is displayed at the left of the selected command.
- After the command is fixed, press the <MENU> button to close the detailed setting screen.

12) Press ▲▼◀▶ to select [STORE], and press the <ENTER> button.

Note

- To delete a command that has been already set, press the <DEFAULT> button on the remote control while the screen in Step 5) is displayed, or select [DELETE] at the screen in Step 6) and press the <ENTER> button.
- If multiple commands have been set for the same time, they are executed in chronological order starting from the smallest command number.
- The operating time will be the local time. (➡ page 109)
- If an operation is executed with the remote control or control panel of the projector or with a control command before the command set in [SCHEDULE] is executed, the command set with the schedule function may not be executed.

[INITIAL STARTUP]

Set the startup method when the <MAIN POWER> switch is set to <ON>.

1) Press ▲▼ to select [INITIAL STARTUP].

2) Press ◀▶ to switch the item.

- The items will switch each time you press the button.

[LAST MEMORY]	Starts up the projector in the condition before the <MAIN POWER> switch is set to <OFF>.
[STANDBY]	Starts up the projector in standby.
[ON]	Starts projecting immediately.

[STARTUP INPUT SELECT]

Set the input when the projector is switched on to start projection.

1) Press ▲▼ to select [STARTUP INPUT SELECT].

2) Press the <ENTER> button.

- The [STARTUP INPUT SELECT] screen is displayed.

3) Press ▲▼◀▶ to select the input, and press the <ENTER> button.

[LAST USED]	Keeps the input selected last.
[COMPUTER1]	Sets the input to COMPUTER1.
[COMPUTER2]	Sets the input to COMPUTER2.
[VIDEO]	Sets the input to VIDEO.
[DVI-D]	Sets the input to DVI-D.
[HDMI1]	Sets the input to HDMI1.
[HDMI2]	Sets the input to HDMI2.
[DIGITAL LINK]	Sets the input to DIGITAL LINK.
[INPUT1] - [INPUT10]*1	Sets the input to DIGITAL LINK, and switches the input of the Panasonic twisted-pair-cable transmitter to the specified input.

*1 When the optional DIGITAL LINK output supported device (Model No.: ET-YFB100G, ET-YFB200G) is connected to the projector, its input name is automatically reflected from [INPUT1] to [INPUT10]. When an item that does not reflect the input name is selected, it will be disabled.

[RS-232C]

Set the communication condition of the <SERIAL IN> terminal. Refer to “<SERIAL IN> terminal” (➡ page 163).

- 1) Press ▲▼ to select [RS-232C].
- 2) Press the <ENTER> button.
 - The [RS-232C] screen is displayed.
- 3) Press ▲▼ to select [INPUT SELECT].
- 4) Press ◀▶ to switch the item.

[PROJECTOR]	Performs the RS-232C communication with the <SERIAL IN> terminal of the projector.
[DIGITAL LINK]	Performs the RS-232C communication via the optional DIGITAL LINK output supported device (Model No.: ET-YFB100G, ET-YFB200G) and the <DIGITAL LINK/LAN> terminal.

- 5) Press ▲▼ to select [BAUDRATE].
- 6) Press ◀▶ to switch the item.
 - The items will switch each time you press the button.

[9600]	Select the proper speed.
[19200]	
[38400]	

- 7) Press ▲▼ to select [PARITY].
- 8) Press ◀▶ to switch the item.
 - The items will switch each time you press the button.

[NONE]	Select the parity condition.
[EVEN]	
[ODD]	

Note

- When [INPUT SELECT] is set to [DIGITAL LINK], communication using that serial terminal is available only when the corresponding device (such as the optional DIGITAL LINK output supported device (Model No.: ET-YFB100G, ET-YFB200G)) is connected to the <DIGITAL LINK/LAN> terminal.
- When transferring logos via the optional DIGITAL LINK output supported device (Model No.: ET-YFB100G, ET-YFB200G), setting for “NO SIGNAL SLEEP” of the DIGITAL LINK output supported device should be set to “OFF” to avoid interruption of communication.
- The input communication speed is fixed to 9 600 bps when [INPUT SELECT] is set to [DIGITAL LINK].

[FUNCTION BUTTON]

Set the function of the <FUNCTION> button on the remote control.

- 1) Press ▲▼ to select [FUNCTION BUTTON].

- 2) Press the <ENTER> button.
 - The [FUNCTION BUTTON] screen is displayed.
- 3) Press ▲▼ to select a function.

[DISABLE]	Disables the <FUNCTION> button.
[SUB MEMORY]	Displays the sub memory list. (➔ page 117)
[SYSTEM SELECTOR]	Switches the [SYSTEM SELECTOR] setting. (➔ page 66)
[DAYLIGHT VIEW]	Switches the [DAYLIGHT VIEW] setting. (➔ page 65)
[WAVEFORM MONITOR]	Displays the waveform of the input signal. (➔ page 93)

- 4) Press the <ENTER> button.

[AUDIO SETTING]

Set audio functions in detail.

Adjusting the volume

- 1) Press ▲▼ to select [AUDIO SETTING].
- 2) Press the <ENTER> button.
 - The [AUDIO SETTING] screen is displayed.
- 3) Press ▲▼ to select [VOLUME].
- 4) Press ◀▶ to adjust the level.

Operation	Adjustment	Range of adjustment
Press ▶.	Increases the volume.	0 - 63
Press ◀.	Decreases the volume.	

Adjusting the left to right audio balance

- 1) Press ▲▼ to select [AUDIO SETTING].
- 2) Press the <ENTER> button.
 - The [AUDIO SETTING] screen is displayed.
- 3) Press ▲▼ to select [BALANCE].
- 4) Press ◀▶ to adjust the level.

Operation	Adjustment	Range of adjustment
Press ▶.	Increases the volume on the right.	L16 - R16
Press ◀.	Decreases the volume on the left.	

Setting audio output in the standby mode

- 1) Press ▲▼ to select [AUDIO SETTING].
- 2) Press the <ENTER> button.
 - The [AUDIO SETTING] screen is displayed.
- 3) Press ▲▼ to select [IN STANDBY MODE].
- 4) Press ◀▶ to switch the item.
 - The items will switch each time you press the button.

[OFF]	Audio is not output during standby.
[ON]	Audio is output during standby.

Note

- Audio is not output in the standby mode when the [PROJECTOR SETUP] menu → [ECO MANAGEMENT] → [STANDBY MODE] is set to [ECO].

Setting audio output while using the shutter function

- 1) Press ▲▼ to select [AUDIO SETTING].
- 2) Press the <ENTER> button.
 - The [AUDIO SETTING] screen is displayed.
- 3) Press ▲▼ to select [IN SHUTTER].
- 4) Press ◀▶ to switch the item.
 - The items will switch each time you press the button.

[OFF]	Audio is not output while using the shutter function (shutter: closed).
[ON]	Audio is output while using the shutter function (shutter: closed).

Setting mute mode

- 1) Press ▲▼ to select [AUDIO SETTING].
- 2) Press the <ENTER> button.
 - The [AUDIO SETTING] screen is displayed.
- 3) Press ▲▼ to select [MUTE].
- 4) Press ◀▶ to switch the item.
 - The items will switch each time you press the button.

[OFF]	Audio is output.
[ON]	Audio is not output.

Setting audio input from a connected device

- 1) Press ▲▼ to select [AUDIO SETTING].
- 2) Press the <ENTER> button.
 - The [AUDIO SETTING] screen is displayed.
- 3) Press ▲▼ to select item to set in [AUDIO IN SELECT].
- 4) Press ◀▶ to switch the item.
 - The items will switch each time you press the button.

[AUDIO IN 1]	Audio connected to the <AUDIO IN 1> terminal is output during projection of image from the set input terminal.
[AUDIO IN 2]	Audio connected to the <AUDIO IN 2> terminal is output during projection of image from the set input terminal.
[AUDIO IN 3]	Audio connected to the <AUDIO IN 3> terminal is output during projection of image from the set input terminal.
[HDMI1 AUDIO IN]*1	Audio input to HDMI1 is output.
[HDMI2 AUDIO IN]*2	Audio input to HDMI2 is output.
[DIGITAL LINK AUDIO IN]*3	Audio input to DIGITAL LINK is output.

*1 Only when the input signal is HDMI1
 *2 Only when the input signal is HDMI2
 *3 Only when the input signal is DIGITAL LINK

[STATUS]

Display the status of the projector.

- 1) Press ▲▼ to select [STATUS].

- 2) Press the <ENTER> button.
 - The [STATUS] screen is displayed.
- 3) Press ◀▶ to switch the pages.
 - The page will change each time you press the button.

[PROJECTOR TYPE]	Displays the projector type and serial number of the projector.	
[PROJECTOR RUNTIME]	Displays the runtime of the projector.	
[LIGHT RUNTIME]	Displays the runtime of the light source.	
[MAIN/SUB VERSION]	Displays the main and sub versions of the firmware of the projector.	
[INTAKE AIR TEMP.]*1	Displays the status of the intake air temperature of the projector.	
[OPTICS MODULE TEMP.]*1	Displays the status of the internal temperature of the projector.	
[EXHAUST AIR TEMP.]*1	Displays the status of the exhaust air temperature of the projector.	
[LIGHT TEMP. 1]*1	Displays the temperature status for the front block of the light source (on the lens side).	
[LIGHT TEMP. 2]*1	Displays the temperature status for the rear block of the light source (on the air exhaust port side).	
[COOLING CONDITION]	Displays the set cooling conditions.	
[ATMOSPHERIC PRESSURE]	Displays the atmospheric pressure.	
[SELF TEST]	Displays the status of the projector.	
[INPUT]	Displays the input terminal currently selected.	
[SIGNAL NAME]	Displays the input signal name.	
[MEMORY NO.]	Displays the memory number of the input signal.	
[ON COUNT]	[POWER ON TIMES]	Displays the number of times the power is turned on.
[NUMBER OF REGISTERED SIGNAL]	Displays the number of registered signals.	
[SIGNAL INFORMATION]	[INPUT]	Displays the input terminal used for the projected image.
	[SIGNAL NAME]	Displays the input signal name.
	[SIGNAL FREQUENCY]	Displays the frequency of the input signal.
	[SYNC.STATE]	Displays the sync polarity of the input signal.
	[V.SYNC WIDTH]	Displays the vertical sync signal pulse width of the input signal.
	[SCAN TYPE]	Displays the scan type of the input signal.
	[TOTAL DOTS]	Displays the total dot count of the input signal.
	[DISPLAY DOTS]	Displays the number of input signal display dots.
	[TOTAL LINES]	Displays the total line count of the input signal.
	[DISPLAY LINES]	Displays the number of input signal display lines.
	[SAMPLING]	Displays the sampling information of the input signal.
	[SIGNAL LEVEL]	Displays the signal level of the input signal.

*1 The temperature status is indicated with text color (green/yellow/red) and bar scale. Use the projector within the range that the indication is green.

Note

- E-mail containing the status can be sent to the E-mail address (up to two addresses) set in "[E-mail set up] page" (➔ page 139) by pressing the <ENTER> button while the [STATUS] screen is displayed.
- There may be items that are displayed and items that are not displayed in [SIGNAL INFORMATION] depending on the setting or the input signal.
- If any abnormality has occurred on the projector, press the <DEFAULT> button while the [STATUS] screen is displayed to display the detail screen of the error information.
- For details on the contents displayed in [SELF TEST], refer to "[SELF TEST] indications" (➔ page 153).

[DATE AND TIME]

Set the time zone, date, and time of the built-in clock of the projector.

Setting the time zone

- 1) Press ▲▼ to select [DATE AND TIME].
- 2) Press the <ENTER> button.
 - The [DATE AND TIME] screen is displayed.
- 3) Press ▲▼ to select [TIME ZONE].
- 4) Press ◀▶ to switch [TIME ZONE].

Setting the date and time manually

- 1) Press ▲▼ to select [DATE AND TIME].
- 2) Press the <ENTER> button.
 - The [DATE AND TIME] screen is displayed.
- 3) Press ▲▼ to select [ADJUST CLOCK].
- 4) Press the <ENTER> button.
 - The [ADJUST CLOCK] screen is displayed.
- 5) Press ▲▼ to select an item, and press ◀▶ to set the local date and time.
- 6) Press ▲▼ to select [APPLY], and press the <ENTER> button.
 - The setting of the date and time will be completed.

Setting the date and time automatically

- 1) Press ▲▼ to select [DATE AND TIME].
- 2) Press the <ENTER> button.
 - The [DATE AND TIME] screen is displayed.
- 3) Press ▲▼ to select [ADJUST CLOCK].
- 4) Press the <ENTER> button.
 - The [ADJUST CLOCK] screen is displayed.
- 5) Press ▲▼ to select [NTP SYNCHRONIZATION], and press ◀▶ to change the setting to [ON].
- 6) Press ▲▼ to select [APPLY], and press the <ENTER> button.
 - The setting of the date and time will be completed.

Note

- To set the date and time automatically, the projector must be connected to the network.
- If synchronization with the NTP server fails just after [NTP SYNCHRONIZATION] is set to [ON], [NTP SYNCHRONIZATION] will return to [OFF]. If [NTP SYNCHRONIZATION] is set to [ON] while the NTP server is not set, [NTP SYNCHRONIZATION] will return to [OFF].
- Access the projector via a web browser to set the NTP server. Refer to “[Adjust clock] page” (► page 138) for details.
- The [TIME ZONE] setting is reset to the factory default when the [PROJECTOR SETUP] menu → [INITIALIZE] → [ALL USER DATA] is executed. However, the date and time based on the local date and time setting (Coordinated Universal Time, UTC, Universal Time, Coordinated) will be maintained without being initialized.

[SAVE ALL USER DATA]

Save the various setting values as a backup in the built-in memory of the projector.

- 1) Press ▲▼ to select [SAVE ALL USER DATA].
- 2) Press the <ENTER> button.
 - The [SECURITY PASSWORD] screen is displayed.
- 3) Enter a security password and press the <ENTER> button.
- 4) When the confirmation screen is displayed, press ◀▶ to select [OK], and press the <ENTER> button.
 - [PROGRESS] is displayed while saving data.

Note

- Data set from the computer application is not included in [ALL USER DATA].

[LOAD ALL USER DATA]

Load the various setting values saved as a backup in the built-in memory of the projector.

- 1) Press ▲▼ to select [LOAD ALL USER DATA].

- 2) Press the <ENTER> button.
 - The [SECURITY PASSWORD] screen is displayed.
- 3) Enter a security password and press the <ENTER> button.
- 4) When the confirmation screen is displayed, press ◀▶ to select [OK], and press the <ENTER> button.

Note

- The projector enters the standby mode to reflect the setting values when [LOAD ALL USER DATA] is executed.
- Data registered from a computer is not included in [ALL USER DATA].

[INITIALIZE]

Return various setting values to their factory default settings.

- 1) Press ▲▼ to select [INITIALIZE].
- 2) Press the <ENTER> button.
 - The [SECURITY PASSWORD] screen is displayed.
- 3) Enter a security password and press the <ENTER> button.
 - The [INITIALIZE] screen is displayed.
- 4) Press ▲▼ to select an item to initialize.

[ALL USER DATA]	Returns all setting values including [REGISTERED SIGNAL], [NETWORK/E-MAIL], and [LOGO IMAGE] to the factory default settings. The projector enters the standby mode to reflect the setting values.
[REGISTERED SIGNAL]	Deletes all the setting values saved for each input signal. To delete only a part of a registered signal, perform the procedure described in “Deleting the registered signal” (➔ page 115).
[NETWORK/E-MAIL]	Returns the setting of the [NETWORK] menu → [NETWORK SETUP] and the setting of “[E-mail set up] page” (➔ page 139) in the web control screen to the factory default settings.
[LOGO IMAGE]	Deletes the image registered in [USER LOGO].

- 5) Press the <ENTER> button.
- 6) When the confirmation screen is displayed, press ◀▶ to select [OK], and press the <ENTER> button.

Note

- The following settings are not initialized even if [ALL USER DATA] is executed.
 - The [DISPLAY OPTION] menu → [UNIFORMITY]
 - The [PROJECTOR SETUP] menu → [ECO MANAGEMENT] → [STANDBY MODE]

[SERVICE PASSWORD]

This function is used by a service person.

[P IN P] menu

On the menu screen, select [P IN P] from the main menu, and select an item from the sub-menu. Refer to “Navigating through the menu” (➔ page 57) for the operation of the menu screen.

Using P IN P function

Locate a separate, small sub screen in the main screen to project two images simultaneously.

- 1) Press ▲▼ to select [P IN P MODE].
- 2) Press the <ENTER> button.
 - The [P IN P MODE] screen is displayed.
- 3) Press ▲▼ to select a function.

[OFF]	P IN P function is not used.
[USER1]	The P IN P function is used with the setting set in “Setting P IN P function” (➔ page 112).
[USER2]	
[USER3]	

- 4) Press the <ENTER> button.

Setting P IN P function

P IN P function settings can be saved to [USER1], [USER2], and [USER3].

- 1) Press ▲▼ to select [P IN P MODE].
- 2) Press the <ENTER> button.
 - The [P IN P MODE] screen is displayed.
- 3) Press ▲▼ to select the desired mode from [USER1], [USER2], and [USER3], and press the <ENTER> button.
- 4) Press ▲▼ to select [MAIN WINDOW] or [SUB WINDOW], and press the <ENTER> button.
- 5) Press ▲▼ to select the input terminal to be displayed in the window, and press the <ENTER> button.
- 6) Press ▲▼ to select an item.

[SIZE]	Sets the window display size between 10 % and 100 %.
[POSITION]	Sets the window display position within the screen.
[CLOCK PHASE]	Sets the value between 0 and +31 when the sub window receives a signal from the <COMPUTER 1 IN> terminal or the <COMPUTER 2 IN/1 OUT> terminal and flickering image or smeared outline appears.

- 7) If [SIZE] is selected in Step 6), press the <ENTER> button.
 - The sub-menu is displayed.
- 8) Press ▲▼ to select an item.
- 9) Press ◀▶ to make adjustment, and press the <MENU> button.
- 10) If [POSITION] is selected in Step 6), press the <ENTER> button.
- 11) Press ▲▼◀▶ to adjust the position, and press the <MENU> button.
- 12) If [CLOCK PHASE] is selected in Step 6), press ◀▶ to make adjustment.
- 13) Press ▲▼ to select [FRAME LOCK].
- 14) Press ◀▶ to switch the item.
 - The items will switch each time you press the button.

[MAIN WINDOW]	Sets the frame lock for the input signal set in the main window.
[SUB WINDOW]	Sets the frame lock for the input signal set in the sub window.

15) Press ▲▼ to select [TYPE].

16) Press ◀▶ to switch the item.

[MAIN WINDOW]	The main window has display priority.
[SUB WINDOW]	The sub window has display priority.

Note

- The P IN P function may not be available for some signals being input or terminals being selected. Refer to “Two-window display combination list” (➔ page 166) for details.
- The main window setting values are applied as image adjustment values such as the [PICTURE] menu → [PICTURE MODE]/[GAMMA]/[COLOR TEMPERATURE].
- While in the normal screen (where no menu is displayed), the sizes and positions of the main window and the sub window can be switched using ▲▼ while P IN P is operating.
- [P IN P] cannot be set when the [ADVANCED MENU] menu → [FRAME RESPONSE] is set to [FAST].

[TEST PATTERN] menu

On the menu screen, select [TEST PATTERN] from the main menu.

Refer to “Navigating through the menu” (➔ page 57) for the operation of the menu screen.

[TEST PATTERN]

Display the test pattern built-in to the projector.

Settings of position, size, and other factors will not be reflected in test patterns. Make sure to display the input signal before performing various adjustments.

1) Press ◀▶ to switch the [TEST PATTERN] item.

- The items will switch each time you press the button.

Menu screen + All white	Displays a test pattern with the menu screen. Select a desired test pattern.
Menu screen + All black	
Menu screen + Window	
Menu screen + Window (inversion)	
Menu screen + Color bar (vertical)	
Menu screen + Color bar (horizontal)	
Menu screen + 16:9/4:3 aspect frame	
Menu screen + Focus	
Menu screen + Input screen	Displays the menu screen and input signal. Internal test patterns are not displayed.

Note

- Press the <ON SCREEN> button on the remote control while the test pattern is displayed to hide the menu screen.

Changing color or a focus test pattern

The color can be changed when the “Menu screen + Focus” test pattern is displayed.

1) Press ◀▶ to select the “Menu screen + Focus” test pattern.

2) Press the <ENTER> button.

- The [TEST PATTERN COLOR] screen is displayed.

3) Press ▲▼ to select a color, and press the <ENTER> button.

- The color of the focus test pattern will be changed to the selected color.

Note

- The [TEST PATTERN COLOR] setting returns to [WHITE] when the projector is switched off.
- Colors of the test patterns other than focus test patterns cannot be changed.

[SIGNAL LIST] menu

On the menu screen, select [SIGNAL LIST] from the main menu.

Refer to “Navigating through the menu” (➔ page 57) for the operation of the menu screen.

■ Registered signal details

Memory number: A1 (1-2)



When the address number (A1, A2, ... L7, L8) signal is registered

- A name can be set for each sub memory (➔ page 117).

Registering new signals

After a new signal is input and the <MENU> button on the remote control or the control panel is pressed, the registration is completed and the [MAIN MENU] screen is displayed.

Note

- Up to 96 signals, including sub memories, can be registered to the projector.
- There are 12 pages (eight memories of A through L, with eight memories possible on each page) for memory numbers, and the signal is registered to the lowest number that is available. If there is no available memory number it will be overwritten from the oldest signal.
- The name to be registered is automatically determined by the input signal.
- If a menu is being displayed, the new signals will be registered at the instant they are input.

Renaming the registered signal

Registered signals can be renamed.

- 1) Press ▲▼◀▶ to select the signal of which name is to be changed.
- 2) Press the <ENTER> button.
 - The [REGISTERED SIGNAL STATUS] screen is displayed.
 - The memory number, input terminal, input signal name, frequency, synch polarity, etc., are displayed.
 - Press the <MENU> button to return to the [SIGNAL LIST] screen.
- 3) Press the <ENTER> button.
 - The [REGISTERED SIGNAL SETUP] screen is displayed.
- 4) Press ▲▼ to select [SIGNAL NAME CHANGE].
- 5) Press the <ENTER> button.
 - The [SIGNAL NAME CHANGE] screen is displayed.
- 6) Press ▲▼◀▶ to select the text, and press the <ENTER> button to enter the text.
- 7) After the name is changed, press ▲▼◀▶ to select [OK], and press the <ENTER> button.
 - The registration is completed and the [REGISTERED SIGNAL SETUP] screen returns.
 - When pressing ▲▼◀▶ to select [CANCEL] and pressing the <ENTER> button, the changed signal name will not be registered and an automatically registered signal name will be used.

Deleting the registered signal

Registered signals can be deleted.

- 1) Press ▲▼◀▶ to select the signal to delete.
- 2) Press the <DEFAULT> button on the remote control.
 - The [REGISTERED SIGNAL DELETE] screen is displayed.
 - To cancel the deletion, press the <MENU> button to return to the [REGISTERED SIGNAL LIST] screen.
- 3) Press the <ENTER> button.
 - The selected signal will be deleted.

Note

- A registered signal can also be deleted from [REGISTERED SIGNAL DELETE] on the [REGISTERED SIGNAL SETUP] screen.

Protecting the registered signal

- 1) Press **▲▼◀▶** to select the signal to protect.
- 2) Press the **<ENTER>** button.
 - The [REGISTERED SIGNAL STATUS] screen is displayed.
- 3) Press the **<ENTER>** button.
 - The [REGISTERED SIGNAL SETUP] screen is displayed.
- 4) Press **▲▼** to select [LOCK].
- 5) Press **◀▶** to switch the item.
 - The items will switch each time you press the button.

[OFF]	The signal is not protected.
[ON]	The signal is protected.

- A lock icon is displayed at the right of the [SIGNAL LIST] screen when [LOCK] is set to [ON].

**Note**

- When [LOCK] is set to [ON], signal deletion, image adjustment, and automatic setup are not available. To perform these operations, set [LOCK] to [OFF].
- A signal can be registered to the sub memory even if it is protected.
- Even a protected signal will be deleted if [INITIALIZE] is executed.

Expanding signal lock-in range

- 1) Press **▲▼◀▶** to select the signal to set.
- 2) Press the **<ENTER>** button.
 - The [REGISTERED SIGNAL STATUS] screen is displayed.
- 3) Press the **<ENTER>** button.
 - The [REGISTERED SIGNAL SETUP] screen is displayed.
- 4) Press **▲▼** to select [LOCK-IN RANGE].
- 5) Press **◀▶** to switch the item.
 - The items will switch each time you press the button.

[NARROW]	Select this item usually.
[WIDE]	Widens the lock-in range.

- An expansion icon is displayed at the right of the [SIGNAL LIST] screen when [LOCK-IN RANGE] is set to [WIDE].

**Note**

- Switch the range where the signal to be input is determined to be the same signal as the already registered signal.
- To prioritize the determination that a signal is the same as the already registered signal, set this function to [WIDE].
- Use in cases such as when the synchronizing frequency of a signal to be input has changed slightly, or multiple signal lists are registered.
- This function can be used only when a signal is input from the <COMPUTER 1 IN> terminal, the <COMPUTER 2 IN/1 OUT> terminal, the <DVI-D IN> terminal, the <HDMI 1 IN> terminal, the <HDMI 2 IN> terminal, or the <DIGITAL LINK/LAN> terminal.
- When [WIDE] is set, the image may be distorted because a signal is recognized as the same even if its synchronizing frequency varies slightly.
- When a signal to be input corresponds to multiple signals set in [WIDE], a registered signal with a high memory number receives priority. Example: a signal to be input that corresponds to memory numbers A2, A4 and B1 will be determined to be B1.
- When a registration signal is deleted, the settings are also deleted.

- In an environment where multiple types of signals are input to the same terminal, signals are sometimes not determined correctly when the setting is set to [WIDE].

Sub memory

The projector has a sub memory function that can register the multiple image adjustment data, even if it is recognized as the same signal by the frequency or format of the synchronization signal source.

Use this function when you need to switch the aspect or adjust the picture quality such as the white balance while using the same signal source. The sub memory includes all the data that can be adjusted for each signal, such as the image aspect ratio and data adjusted in the [PICTURE] menu (items such as [CONTRAST] and [BRIGHTNESS]).

Registering to the sub memory

- 1) **While in the normal screen (where no menu is displayed), press ▲▼.**
 - The sub memory registration screen is displayed if the sub memory is not registered. Proceed to Step 3).
 - A list of sub memories registered to the signal currently input is displayed.
 - The <FUNCTION> button on the remote control can be used instead of ▲▼ when [SUB MEMORY] is selected from the [PROJECTOR SETUP] menu → [FUNCTION BUTTON].
- 2) **Press ▲▼◀▶ to select the sub memory number to register in [SUB MEMORY LIST].**
- 3) **Press the <ENTER> button.**
 - The [SIGNAL NAME CHANGE] screen is displayed.
- 4) **Press ▲▼◀▶ to select [OK], and press the <ENTER> button.**
 - To rename the registered signal, follow the procedure in Steps 6) and 7) in “Renaming the registered signal” (➔ page 115).

Switching to the sub memory

- 1) **While in the normal screen (where no menu is displayed), press ▲▼.**
 - A list of sub memories registered to the signal currently input is displayed.
- 2) **Press ▲▼◀▶ to select the signal to switch in [SUB MEMORY LIST].**
- 3) **Press the <ENTER> button.**
 - This switches to the signal selected in Step 2).

Deleting the sub memory

- 1) **While in the normal screen (where no menu is displayed), press ▲▼.**
 - The [SUB MEMORY LIST] screen is displayed.
- 2) **Press ▲▼◀▶ to select the sub memory to be deleted, and press the <DEFAULT> button on the remote control.**
 - The [REGISTERED SIGNAL DELETE] screen is displayed.
 - To cancel the deletion, press the <MENU> button to return to the [SUB MEMORY LIST] screen.
- 3) **Press the <ENTER> button.**
 - The selected sub memory will be deleted.

[SECURITY] menu

On the menu screen, select [SECURITY] from the main menu, and select an item from the sub-menu. Refer to “Navigating through the menu” (➔ page 57) for the operation of the menu screen.

- When the projector is used for the first time
Initial password: Press ▲▶▼◀▲▶▼◀ in order, and press the <ENTER> button.

Attention

- When you select the [SECURITY] menu and press the <ENTER> button, entering a password is prompted. Enter the preset password and then continue operations of the [SECURITY] menu.
- When the password has been changed previously, enter the changed password, and press the <ENTER> button.

Note

- The entered password is displayed with * marks on the screen.
- An error message is displayed on the screen when the entered password is incorrect. Re-enter the correct password.

[SECURITY PASSWORD]

Display the [SECURITY PASSWORD] screen when the power is turned on with the <MAIN POWER> switch set to the <OFF> side. When the entered password is incorrect, the operation will be restricted to the power <⏻/⏻> button.

- 1) Press ▲▼ to select [SECURITY PASSWORD].
- 2) Press ◀▶ to switch the item.
 - The items will switch each time you press the button.

[OFF]	Disables the security password entry.
[ON]	Enables the security password entry.

Note

- This item is set to [OFF] in the factory default setting or when the [PROJECTOR SETUP] menu → [INITIALIZE] → [ALL USER DATA] is executed. Set it to [ON] as necessary.
- Change the password periodically that is hard to guess.
- The security password is enabled after setting the item to [ON] and setting the <MAIN POWER> switch to <OFF>.

[SECURITY PASSWORD CHANGE]

Change the security password.

- 1) Press ▲▼ to select [SECURITY PASSWORD CHANGE].
- 2) Press the <ENTER> button.
 - The [SECURITY PASSWORD CHANGE] screen is displayed.
- 3) Press ▲▼◀▶ and the number (<0> - <9>) buttons to set the password.
 - Up to eight button operations can be set.
- 4) Press the <ENTER> button.
- 5) Re-enter the password for the confirmation.
- 6) Press the <ENTER> button.

Note

- The entered password is displayed with * marks on the screen.
- When numerical values are used for the security password, the security password is required to be initialized if the remote control is lost. Consult your dealer for the method of initialization.

[DISPLAY SETTING]

Overlap the security message (text or image) over the projecting image.

- 1) Press ▲▼ to select [DISPLAY SETTING].

2) Press ◀▶ to switch the item.

- The items will switch each time you press the button.

[OFF]	Hides the security message.
[TEXT]	Displays the text set in the [SECURITY] menu → [TEXT CHANGE].
[USER LOGO]	Displays the image registered by the user.

Note

- To create/register the [USER LOGO] image, use “Logo Transfer Software” included in the supplied CD-ROM.

[TEXT CHANGE]

Edit the text to be displayed when [TEXT] is selected in [DISPLAY SETTING].

- 1) Press ▲▼ to select [TEXT CHANGE].
- 2) Press the <ENTER> button.
 - The [TEXT CHANGE] screen is displayed.
- 3) Press ▲▼◀▶ to select the text, and press the <ENTER> button to enter the text.
- 4) Press ▲▼◀▶ to select [OK], and press the <ENTER> button.
 - The text is changed.

[CONTROL DEVICE SETUP]

Enable/disable the button operations on the control panel and the remote control.

- 1) Press ▲▼ to select [CONTROL DEVICE SETUP].
- 2) Press the <ENTER> button.
 - The [CONTROL DEVICE SETUP] screen is displayed.
- 3) Press ▲▼ to select [CONTROL PANEL] or [REMOTE CONTROL].

[CONTROL PANEL]	Sets the limitation on the control from the control panel.
[REMOTE CONTROL]	Sets the limitation on the control from the remote control.

- 4) Press the <ENTER> button.
 - The [CONTROL PANEL] screen or the [REMOTE CONTROL] screen is displayed.
- 5) Press ▲▼ to select [CONTROL PANEL] or [REMOTE CONTROL].
- 6) Press ◀▶ to switch the item.
 - You can set the operation restriction from the control panel or the remote control.

[ENABLE]	Enables all button operations.
[DISABLE]	Disables all button operations.
[USER]	Operation of all buttons can be enabled/disabled separately. Refer to “Enabling/disabling any button” (➔ page 119) for details.

- 7) Press ▲▼ to select [APPLY], and press the <ENTER> button.
 - The confirmation screen is displayed.
- 8) Press ◀▶ to select [OK], and press the <ENTER> button.

Enabling/disabling any button

- 1) Press ▲▼ to select [CONTROL DEVICE SETUP].
- 2) Press the <ENTER> button.
 - The [CONTROL DEVICE SETUP] screen is displayed.
- 3) Press ▲▼ to select [CONTROL PANEL] or [REMOTE CONTROL].

- 4) Press the <ENTER> button.
 - The [CONTROL PANEL] screen or the [REMOTE CONTROL] screen is displayed.
- 5) Press ▲▼ to select [CONTROL PANEL] or [REMOTE CONTROL].
- 6) Press ◀▶ to switch [USER].
- 7) Press ▲▼ to select the button item to set.
 - When [INPUT SELECT BUTTON] is selected in [REMOTE CONTROL], press the <ENTER> button, and then press ▲▼ to select the button to set.

	Buttons that can be set	
	[CONTROL PANEL]	[REMOTE CONTROL]
[POWER BUTTON]	Power <⏻/ >button	
[INPUT SELECT BUTTON]	<INPUT SELECT> button	<COMPUTER 1/2> button, <VIDEO> button, <DVI-D> button, <HDMI 1> button, <HDMI 2> button, <DIGITAL LINK> button
[MENU BUTTON]	<MENU> button	
[AUTO SETUP BUTTON]	—	<AUTO SETUP> button
[ON SCREEN BUTTON]	—	<ON SCREEN> button
[OTHER BUTTON]	▲▼◀▶, <ENTER> button	Buttons not listed above

- 8) Press ◀▶ to switch the item.

[ENABLE]	Enables button operations.
[DISABLE]	Disables button operations.

- Following items can be selected only when [COMPUTER1/2 BUTTON] is selected in [INPUT SELECT BUTTON].

[TOGGLE]	Switches between [COMPUTER1] and [COMPUTER2] when the button is operated.
[COMPUTER1]	Fixes to [COMPUTER1].
[COMPUTER2]	Fixes to [COMPUTER2].
[DISABLE]	Disables button operations.

- When [INPUT SELECT BUTTON] is selected in Step 7), pressing the <MENU> button returns to the [CONTROL PANEL] screen or the [REMOTE CONTROL] screen once the item is switched.

- 9) Press ▲▼ to select [APPLY], and press the <ENTER> button.
 - The confirmation screen is displayed.
- 10) Press ◀▶ to select [OK], and press the <ENTER> button.

Note

- When a button operation is performed on the device set to [DISABLE], the [CONTROL DEVICE PASSWORD] screen is displayed. Enter the control device password.
- The [CONTROL DEVICE PASSWORD] screen will disappear when there is no operation for approx. 10 seconds.
- If the operations of both [CONTROL PANEL] and [REMOTE CONTROL] are set to [DISABLE], the projector cannot be turned off (cannot enter standby).
- When the setting has completed, the menu screen will disappear. To operate continuously, press the <MENU> button to display the main menu.
- Even when you set button operations on the remote control disabled, operations of the <ID SET> and <ID ALL> buttons on the remote control are kept enabled.

[CONTROL DEVICE PASSWORD CHANGE]

The control device password can be changed.

- 1) Press ▲▼ to select [CONTROL DEVICE PASSWORD CHANGE].
- 2) Press the <ENTER> button.
 - The [CONTROL DEVICE PASSWORD CHANGE] screen is displayed.
- 3) Press ▲▼◀▶ to select the text, and press the <ENTER> button to enter the text.
- 4) Press ▲▼◀▶ to select [OK], and press the <ENTER> button.
 - To cancel, select [CANCEL].

Attention

- The initial password is “AAAA” as the factory default or when the [PROJECTOR SETUP] menu → [INITIALIZE] → [ALL USER DATA] is executed.
- Change the password periodically that is hard to guess.

[NETWORK] menu

On the menu screen, select [NETWORK] from the main menu, and select an item from the sub-menu. Refer to “Navigating through the menu” (➔ page 57) for the operation of the menu screen.

[DIGITAL LINK MODE]

Switch the communication method of the <DIGITAL LINK/LAN> terminal of the projector.

- 1) Press ▲▼ to select [DIGITAL LINK MODE].
- 2) Press ◀▶ to switch the item.
 - The items will switch each time you press the button.

[AUTO]	Switches the communication method automatically to DIGITAL LINK, long reach, or Ethernet.
[DIGITAL LINK]	Fixes the communication method to DIGITAL LINK.
[LONG REACH]	Fixes the communication method to long reach.
[ETHERNET]	Fixes the communication method to Ethernet.

Possible communication modes

- ✓: Communication possible
—: Communication not possible

Setting		Communication possible			
		Video transfer (100 m (328'1"))	Video transfer (150 m (492'2"))	Ethernet	RS-232C
[AUTO]	For DIGITAL LINK	✓	—	✓	✓
	For long reach	—	✓	✓	✓
	For Ethernet	—	—	✓*1	—
[DIGITAL LINK]		✓	—	✓	✓
[LONG REACH]		—	✓	✓	✓
[ETHERNET]		—	—	✓*1	—

*1 Communication via a twisted-pair-cable transmitter is not available. Connect the projector to the network directly.

Note

- The maximum transmission distance when connected with the long-reach communication method is 150 m (492'2"). In this case, the signal that the projector can receive is only up to 1080/60p (1 920 x 1 080 dots, dot clock frequency 148.5 MHz).
- If the communication method of the twist-pair-cable transmitter is set to long reach, the projector will connect with long-reach communication method when the item is set to [AUTO]. To connect with the optional DIGITAL LINK Switcher (Model No.: ET-YFB200G) with the long-reach communication method, set the item to [LONG REACH].
- Even when the item is set to [LONG REACH], connection will not be made correctly if the twist-pair-cable transmitter is not supporting the long-reach communication method.

[DIGITAL LINK STATUS]

Display the DIGITAL LINK connection environment.

- 1) Press ▲▼ to select [DIGITAL LINK STATUS].
- 2) Press the <ENTER> button.
 - The [DIGITAL LINK STATUS] screen is displayed.

[LINK STATUS]	One of [NO LINK], [DIGITAL LINK], [LONG REACH], or [ETHERNET] is displayed.
[HDCP STATUS]	One of [NO SIGNAL], [OFF], or [ON] is displayed.
[SIGNAL QUALITY]	<p>[SIGNAL QUALITY] is a numerical value of the amount of error, and the display color changes to green, yellow, or red depending on that value. Check the signal quality level while receiving a signal from the twisted-pair-cable transmitter.</p> <ul style="list-style-type: none"> • [MAX]/[MIN]: Maximum/minimum value of the amount of error • Green (–12 dB or lower) → normal signal quality level. • Yellow (–11 to –8 dB) → caution level that noise may appear on the screen. • Red (–7 dB or higher) → abnormal level with interrupted synchronization and receiving not possible.

[NETWORK SETUP]

Perform the initial setting of the network before using the network function.

- 1) Press ▲▼ to select [NETWORK SETUP].
- 2) Press the <ENTER> button.
 - The [NETWORK SETUP] screen is displayed.
- 3) Press ▲▼ to select an item, and change the settings according to the operation instructions of the menu.

[PROJECTOR NAME]	Allows to change the projector name. Enter the host name if it is required to use a DHCP server.	
[DHCP]	[ON]	If a DHCP server exists in the network where the projector is to be connected, obtains the IP address automatically.
	[OFF]	If a DHCP server does not exist in the network where the projector is to be connected, set [IP ADDRESS], [SUBNET MASK], and [DEFAULT GATEWAY].
[IP ADDRESS]	Enter the IP address when a DHCP server is not used.	
[SUBNET MASK]	Enter the subnet mask when a DHCP server is not used.	
[DEFAULT GATEWAY]	Enter the default gateway address when a DHCP server is not used.	

- 4) Press ▲▼ to select [STORE], and press the <ENTER> button.
- 5) When the confirmation screen is displayed, press ◀▶ to select [OK], and press the <ENTER> button.

Note

- When using a DHCP server, confirm that the DHCP server is running.
- Consult your network administrator regarding the IP address, subnet mask, and default gateway.
- The network setting is common for the <LAN> terminal and the <DIGITAL LINK/LAN> terminal.
- [NETWORK SETUP] cannot be selected when the [NETWORK] menu → [Art-Net SETUP] is set to [ON(2.X.X.X)] or [ON(10.X.X.X)].

[NETWORK CONTROL]

Set up the control method of the network.

- 1) Press ▲▼ to select [NETWORK CONTROL].
- 2) Press the <ENTER> button.
 - The [NETWORK CONTROL] screen is displayed.
- 3) Press ▲▼ to select an item, and press ◀▶ to change the setting.

[WEB CONTROL]	Set to [ON] to control with the web browser.
[PJLink CONTROL]	Set to [ON] to control with the PJLink protocol.
[COMMAND CONTROL]	Set to [ON] to control with the control command format (➡ page 165) for the <SERIAL IN> terminal. Refer to "Control commands via LAN" (➡ page 160).
[COMMAND PORT]	Set the port number used for command control.
[Crestron Connected(TM)]	Set to [ON] to control with Crestron Connected™ of Crestron Electronics, Inc.
[AMX D.D.]	Set to [ON] to control with the controller of AMX Corporation. Setting this function to [ON] enables detection through "AMX Device Discovery". For details, visit the website of AMX Corporation. URL http://www.amx.com/
[EXTRON XTP]	Set to [ON] when connecting the "XTP transmitter" of Extron Electronics to the <DIGITAL LINK/LAN> terminal. Set to [OFF] when connecting the optional DIGITAL LINK output supported device (Model No.: ET-YFB100G, ET-YFB200G). For details of the "XTP transmitter", visit the website of Extron Electronics. URL http://www.extron.com/

- 4) Press ▲▼ to select [STORE], and press the <ENTER> button.
- 5) When the confirmation screen is displayed, press ◀▶ to select [OK], and press the <ENTER> button.

[NETWORK STATUS]

Display the status of the projector network.

- 1) Press ▲▼ to select [NETWORK STATUS].
- 2) Press the <ENTER> button.
 - The [NETWORK STATUS] screen is displayed.

[DHCP]	Displays the status of use of the DHCP server.
[IP ADDRESS]	Displays the [IP ADDRESS].
[SUBNET MASK]	Displays the [SUBNET MASK].
[DEFAULT GATEWAY]	Displays the [DEFAULT GATEWAY].
[DNS1]	Displays the address of the preferred DNS server.
[DNS2]	Displays the address of the alternate DNS server.
[MAC ADDRESS]	Displays the [MAC ADDRESS].

Note

- The network setting is common for the <LAN> terminal and the <DIGITAL LINK/LAN> terminal.

[DIGITAL LINK MENU]

When the optional DIGITAL LINK output supported device (Model No.: ET-YFB100G, ET-YFB200G) is connected to the <DIGITAL LINK/LAN> terminal, the main menu of the connected DIGITAL LINK output supported device is displayed. Refer to the Operating Instructions of the DIGITAL LINK output supported device for details.

Note

- [DIGITAL LINK MENU] cannot be selected when the [NETWORK] menu → [NETWORK CONTROL] → [EXTRON XTP] is set to [ON].

[Art-Net SETUP]

Make settings to use the Art-Net function.

- 1) Press ▲▼ to select [Art-Net SETUP].
- 2) Press ◀▶ to switch the item.
 - The items will switch each time you press the button.

[OFF]	Disables the Art-Net function.
[ON(2.X.X.X)]	Enables the Art-Net function and sets the IP address to 2.X.X.X.
[ON(10.X.X.X)]	Enables the Art-Net function and sets the IP address to 10.X.X.X.
[ON(MANUAL)]	Enables the Art-Net function and uses the IP address set in [NETWORK SETUP].

- Proceed to Step 3) when anything other than [OFF] is selected.

- 3) Press the <ENTER> button.
 - The [Art-Net SETUP] screen is displayed.
- 4) Press ▲▼ to select an item, and press ◀▶ to switch the setting.

[NET]	Enter [NET] to be used when the projector processes Art-Net.
[SUB NET]	Enter [SUB NET] to be used when the projector processes Art-Net.
[UNIVERSE]	Enter [UNIVERSE] to be used when the projector processes Art-Net.
[START ADDRESS]	Enter [START ADDRESS] to be used when the projector processes Art-Net.

- 5) Press ▲▼ to select [STORE], and press the <ENTER> button.
- 6) When the confirmation screen is displayed, press ◀▶ to select [OK], and press the <ENTER> button.

Note

- If [ON(2.X.X.X)] or [ON(10.X.X.X)] is selected, IP address is calculated and set automatically.
- The network setting is common for the <LAN> terminal and the <DIGITAL LINK/LAN> terminal.

[Art-Net CHANNEL SETTING]

Set the assignment of the channel.

For the channel definitions used for controlling the projector with the Art-Net function, refer to “Using Art-Net function” (➔ page 157).

- 1) Press ▲▼ to select [Art-Net CHANNEL SETTING].
- 2) Press ◀▶ to switch the item.

[2]	Uses the channel assignment in standard setting.
[USER]	Changes the channel assignment.
[1]	Uses the channel assignment with DZ21K series compatible. DZ21K series: DZ21K series, DS20K series, DW17K series, DZ16K series

- When [2] or [1] is selected, the function assigned to the channel is displayed by pressing the <ENTER> button.
 - When [USER] is selected, proceed to Step 3).
- 3) Press the <ENTER> button.
 - The [Art-Net CHANNEL SETTING] screen is displayed.
 - 4) Press ▲▼ to select the channel to set, and press ◀▶ to switch the item.

[LIGHT OUTPUT]	Adjusts the amount of light.
[INPUT SELECT]	Switches the input.
[POWER]	Controls the power status.
[SHUTTER]	Controls the shutter function.
[FADE-IN]	Sets the fade-in time.
[FADE-OUT]	Sets the fade-out time.
[SCREEN ADJUSTMENT]	Performs screen correction.
[FREEZE]	Freezes the projected image, and turns off the audio.
[COLOR]	Adjusts the color saturation.
[TINT]	Adjusts the tint.
[RASTER PATTERN]	Displays the raster pattern.
[VOLUME]	Adjusts the volume.
[ENABLE / DISABLE]	Enables/disables the control of the projector with the Art-Net function.
[NONE]	No definition

- The setting can be also made by pressing ▲▼ to select the channel, pressing the <ENTER> button to display the item list, pressing ▲▼◀▶ to select the item, and pressing the <ENTER> button.
- Same item cannot be set for multiple channels, except for [NONE].

[Art-Net STATUS]

Display the content of control assigned to each channel and the received data of that channel.

- 1) Press ▲▼ to select [Art-Net STATUS].
- 2) Press the <ENTER> button.
 - The [Art-Net STATUS] screen is displayed.

Chapter 5 Operations

This chapter describes how to use each function.

Network connection

The projector is equipped with the network function, and following is possible by connecting to a computer.

- **Web control**

Setting, adjustment, and displaying status of the projector are possible by accessing the projector from a computer.

Refer to “Web control function” (➔ page 130) for details.

- **Multi Monitoring & Control Software**

“Multi Monitoring & Control Software”, which is a software application to monitor and control multiple display devices (projector or flat panel display) connected via LAN, can be used.

Refer to the Operating Instructions of the “Multi Monitoring & Control Software” in the supplied CD-ROM for details.

- **Early Warning Software**

“Early Warning Software”, which is a software application to monitor the status of the display devices (projector or flat panel display) or the peripheral device within the intranet, and to notify the problem or to detect the sign of possible problem of the device, can be used.

Visit the Panasonic website (<http://panasonic.net/avc/projector/pass/>) for details.

- **PJLink**

Operation or status query of the projector can be performed from a computer using the PJLink protocol.

Refer to “PJLink protocol” (➔ page 156) for details.

- **Art-Net**

Setting of the projector can be operated by the DMX controller or application software using the Art-Net protocol.

Refer to “Using Art-Net function” (➔ page 157) for details.

- **Command control**

Operation or status query of the projector can be performed from a computer using the control command.

Refer to “Control commands via LAN” (➔ page 160) for details.

Connecting to the network

The projector can be connected to the network using the <LAN> terminal or the <DIGITAL LINK/LAN> terminal. The Ethernet signal from a twisted-pair-cable transmitter can be received in the <DIGITAL LINK/LAN> terminal together with the video, audio, and serial control signal via a LAN cable.

- Use either of the <LAN> terminal or the <DIGITAL LINK/LAN> terminal when a twisted-pair-cable transmitter is not used.
- To connect a twisted-pair-cable transmitter that is not supporting send/receive of the Ethernet signal, use the <LAN> terminal.
- To send/receive the Ethernet signal via a twisted-pair-cable transmitter, use the <DIGITAL LINK/LAN> terminal.

Example of a normal network connection

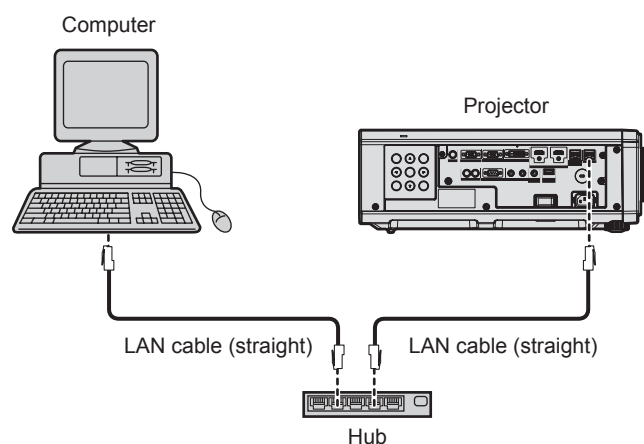

Attention

- When a LAN cable is directly connected to the projector, the network connection must be made indoors.

Note

- A LAN cable is required to use the network function.

- Connect a LAN cable to send/receive the Ethernet signal to the <LAN> terminal or the <DIGITAL LINK/LAN> terminal of the projector.
- Use a straight or crossover LAN cable that is compatible with CAT5 or higher. Either the straight or the crossover cable, or both cables can be used depending on the system configuration. Consult your network administrator. The projector will determine the type of the cable (straight or crossover) automatically.
- Use a LAN cable of 100 m (328'1") or shorter.

Example of network connections via a twisted-pair-cable transmitter

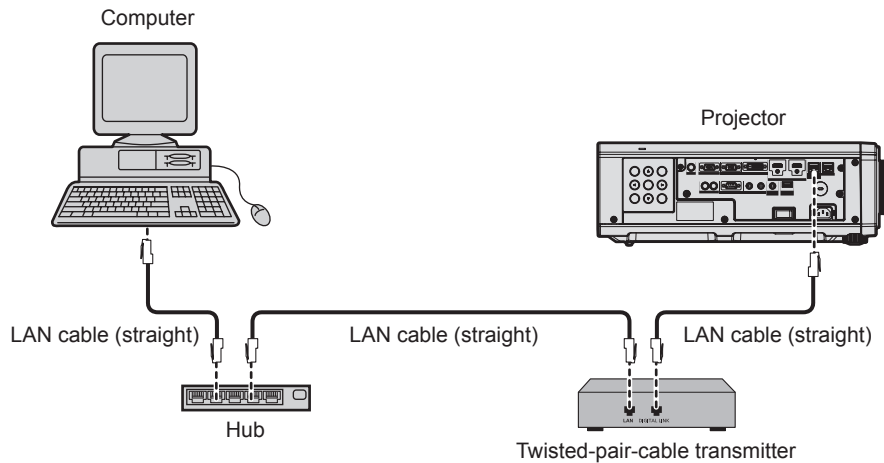

Attention

- When a LAN cable is directly connected to the projector, the network connection must be made indoors.

Note

- For the LAN cable between the twisted-pair-cable transmitter and the projector, use a cable that meets the following criteria:
 - Conforming to CAT5e or higher standards
 - Shielded type (including connectors)
 - Straight-through
 - Single wire
- The maximum transmission distance between the twisted-pair-cable transmitter and the projector is 100 m (328'1"). It is possible to transmit up to 150 m (492'2") if the twisted-pair-cable transmitter supports the long-reach communication method. However, the signal that the projector can receive is only up to 1080/60p (1 920 x 1 080 dots, dot clock frequency 148.5 MHz) for the long-reach communication method. If this distance is exceeded, image may be disrupted or a malfunction may occur in LAN communication.
- When laying cables between the twisted-pair-cable transmitter and the projector, confirm that cable characteristics are compatible with CAT5e or higher using tools such as a cable tester or cable analyzer.
When a relay connector is used, include it in the measurement.
- Do not use a hub between the twisted-pair-cable transmitter and the projector.
- Do not pull cables forcefully. Also, do not bend or fold cables unnecessarily.
- To reduce the effects of noise as much as possible, stretch out the cables between the twisted-pair-cable transmitter and the projector without any loops.
- Lay the cables between the twisted-pair-cable transmitter and the projector away from other cables, particularly power cables.
- When laying multiple cables, run them side by side along the shortest distance possible without bundling them together.
- After laying the cables, go to the [NETWORK] menu → [DIGITAL LINK STATUS] and confirm that the value of [SIGNAL QUALITY] is displayed in green which indicates normal quality.
- For twisted-pair-cable transmitters of other manufacturers of which the operation has been verified with the projector, visit the Panasonic website (<http://panasonic.net/avc/projector/>). Note that the verification for devices of other manufacturers has been made for the items set by Panasonic Corporation, and not all the operations have been verified. For operation or performance problems caused by the devices of other manufacturers, contact the respective manufacturers.

Setting the projector

- 1) **Connect the projector to a computer using a LAN cable.**
- 2) **Turn on the power of the projector.**
- 3) **Press the <MENU> button to open the [NETWORK] menu, select [NETWORK SETUP], and press the <ENTER> button.**
- 4) **Perform the [NETWORK SETUP] setting.**
 - Refer to [NETWORK SETUP] (➡ page 123) for details.

Note

- To connect to an existing network, perform after consulting your network administrator.

■ Factory default setting

- Following setting has been made as a factory default.

[DHCP]	OFF
[IP ADDRESS]	192.168.0.8
[SUBNET MASK]	255.255.255.0
[DEFAULT GATEWAY]	192.168.0.1
[DNS1]/[DNS2]	None

Operating the computer

1) Turn on the power of the computer.

2) Perform the network setting following the instruction of your network administrator.

- Operation from the computer is possible by configuring the network setting of the computer as follows if the projector is in the factory default setting.

[IP ADDRESS]	192.168.0.10
[SUBNET MASK]	255.255.255.0
[DEFAULT GATEWAY]	192.168.0.1

Web control function

Following operation is possible from a computer using the web control function.

- Setting and adjustment of the projector
- Display of the projector status
- Sending E-mail messages when there is a problem with the projector

The projector supports “Crestron Connected™”, and the following application software of Crestron Electronics, Inc. can be used.

- RoomView Express
- Fusion RV
- RoomView Server Edition

Note

- Communication with an E-mail server is required to use the E-mail function. Confirm that the E-mail can be used beforehand.
- “Crestron Connected™” is a system of Crestron Electronics, Inc. that collectively manages and controls devices on multiple systems connected to a network using a computer.
- For details of the “Crestron Connected™”, visit the website of Crestron Electronics, Inc. (English only.)
URL <http://www.crestron.com>
Download “RoomView Express” from the Crestron Electronics, Inc. website. (English only.)
URL <http://www.crestron.com/getroomview>

Computer that can be used for setting

To use the web control function, a web browser is required. Confirm that the web browser can be used in advance.

OS	Compatible browser
Windows	Internet Explorer 9.0/10.0/11.0, Microsoft Edge
Mac OS	Safari 6.0/7.0/8.0/9.0

Accessing from the web browser

- 1) Start up the web browser on the computer.
- 2) Enter the IP address set on the projector into the URL entry field of the web browser.
- 3) Enter the user name and the password.
 - The factory default setting of the user name is user1 (user rights)/admin1 (administrator rights) and the password is panasonic (lower case).

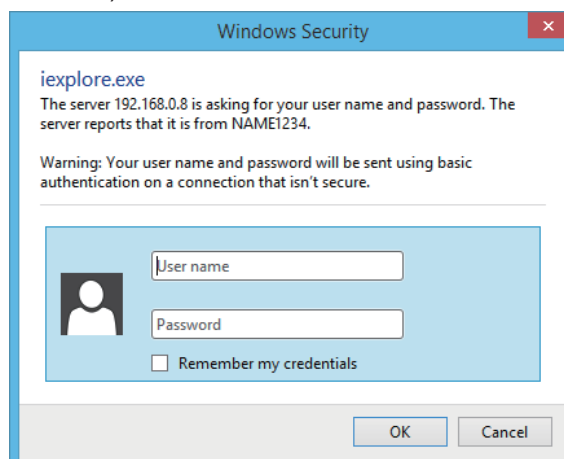

4) Click OK.

- The [Projector status] page is displayed.

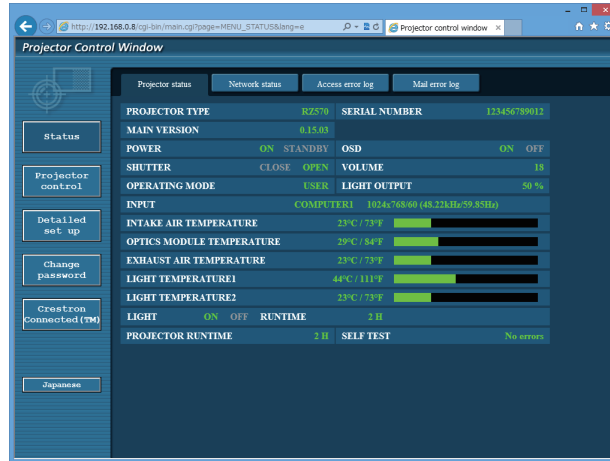

Note

- If you use a web browser to control the projector, set the [NETWORK] menu → [NETWORK CONTROL] → [WEB CONTROL] to [ON].
- Do not perform setting or control simultaneously by starting up multiple web browsers. Do not set or control the projector from multiple computers.
- Change the password first. (➡ page 143)
- Access will be locked for few minutes when an incorrect password is entered three times consecutively.
- Some items on the projector setting page use the Javascript function of the web browser. Correct control may not be possible when the web browser is set not to use this function.
- If the screen for the web control is not displayed, consult your network administrator.
- While updating the screen for the web control, the screen may appear white for a moment, but it is not a malfunction.
- Screenshot of a computer
The size or the display of the screen may be different from this manual depending on the OS or the Web browser, or the type of computer in use.

Rights for each account

The administrator rights allow use of all functions. There is a limitation in the rights that can be used with the user rights. Select the rights depending on the purpose.

The function that has ✓ in the administrator rights/user rights column indicates that it can be operated with that rights.

Item	Function	Administrator rights	User rights	Page
[Projector status]	[Projector status]	✓	✓	132
	Error information page	✓	✓	133
	[Network status]	✓	✓	134
	[Access error log]	✓	—	135
	[Mail error log]	✓	—	135
[Projector control]	[Basic control]	✓	✓	136
	[Detail control]	✓	—	136
[Detailed set up]	[Network config]	✓	—	137
	[Adjust clock]	✓	—	138
	[Ping test]	✓	—	138
	[E-mail set up]	✓	—	139
	[Authentication set up]	✓	—	140
	[ECO management set up]	✓	—	140
[Change password]	User name of [Administrator]	✓	—	143
	User name of [User]	✓	—	144
	Password of [Administrator]	✓	—	143
	Password of [User]	✓	✓	144, 144
[Crestron Connected(TM)]	Operation page	✓	—	145
	[Tools]	✓	—	145
	[Info]	✓	—	146
	[Help]	✓	—	146

Descriptions of items

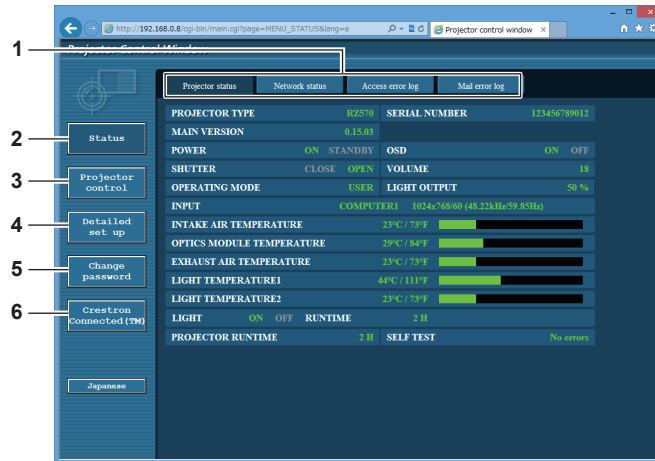

- 1 **Page tab**
Switches pages by clicking this item.
- 2 **[Status]**
The status of the projector is displayed by clicking this item.
- 3 **[Projector control]**
The [Projector control] page is displayed by clicking this item.
- 4 **[Detailed set up]**
The [Detailed set up] page is displayed by clicking this item.
- 5 **[Change password]**
The [Change password] page is displayed by clicking this item.
- 6 **[Crestron Connected(TM)]**
The operation page of Crestron Connected™ is displayed by clicking this item.

[Projector status] page

Click [Status] → [Projector status].

Display the status of the projector for the following items.

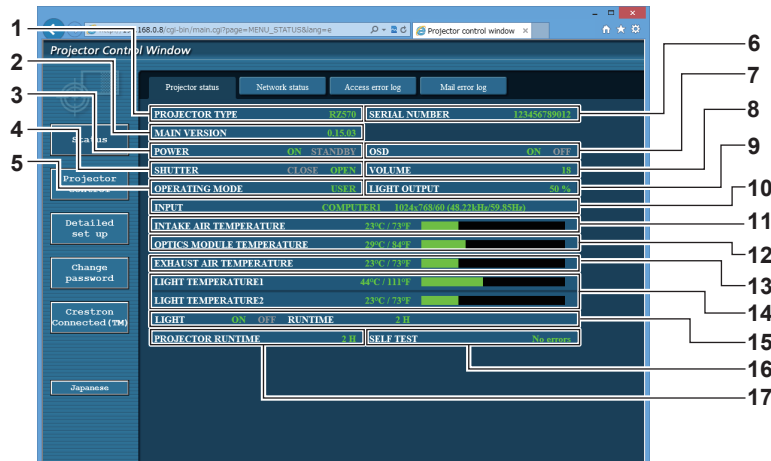

- 1 **[PROJECTOR TYPE]**
Displays the type of the projector.
- 2 **[MAIN VERSION]**
Displays the firmware version of the projector.
- 3 **[POWER]**
Displays the status of the power.
- 4 **[SHUTTER]**
Displays the status of the shutter function ([CLOSE]: Enabled (closed), [OPEN]: Disabled (open)).
- 5 **[OPERATING MODE]**
Displays the setting status of [OPERATING MODE].
- 6 **[SERIAL NUMBER]**
Displays the serial number of the projector.
- 7 **[OSD]**
Displays the status of the on-screen display.
- 8 **[VOLUME]**
Display the volume status.
- 9 **[LIGHT OUTPUT]**
Displays the setting status of [LIGHT OUTPUT].
- 10 **[INPUT]**
Displays the status of the selected input.
- 11 **[INTAKE AIR TEMPERATURE]**
Displays the status of the intake air temperature of the projector.
- 12 **[OPTICS MODULE TEMPERATURE]**
Displays the status of the internal temperature of the projector.
- 13 **[EXHAUST AIR TEMPERATURE]**
Displays the status of the exhaust air temperature of the projector.
- 14 **[LIGHT TEMPERATURE1], [LIGHT TEMPERATURE2]**
Displays the temperature status of the light source.
- 15 **[LIGHT]**
Displays the lighting status and runtime of the light source.
- 16 **[SELF TEST]**
Displays the self-diagnosis information.
- 17 **[PROJECTOR RUNTIME]**
Displays the runtime of the projector.

Error information page

When [Error (Detail)] or [Warning (Detail)] is displayed in the [SELF TEST] display field of the [Projector status] screen, click it to display the content of the error/warning.

- The projector may go into the standby status to protect the projector depending on the contents of the error.

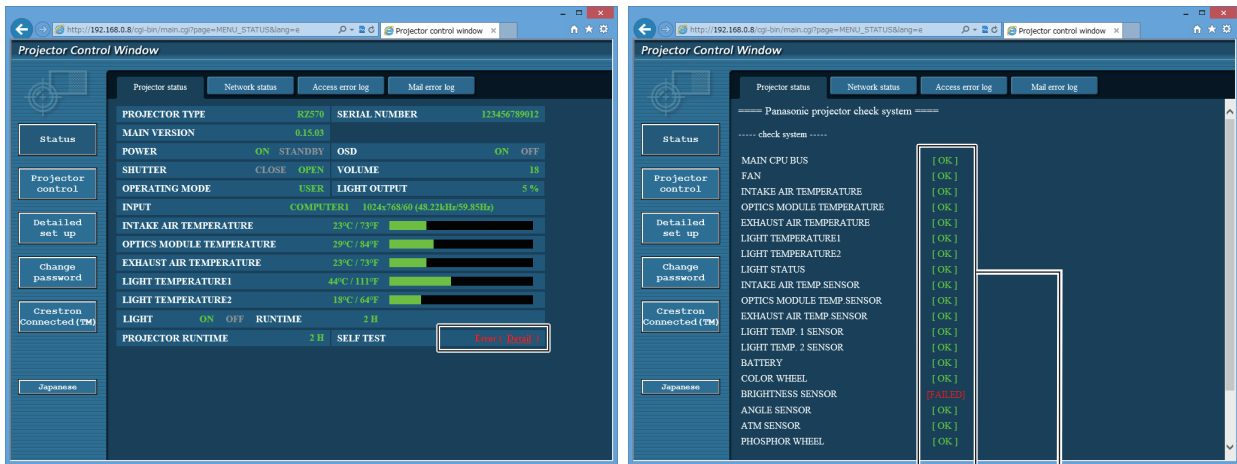

1

1 Self-diagnosis result display

Displays the item check results.

[OK]:

Indicates that operation is normal.

[FAILED]:

Indicates that there is a problem.

[WARNING]:

Indicates that there is a warning.

■ [FAILED] items

Item	Description
[MAIN CPU BUS]	There is a problem with the microcomputer circuitry. Consult your dealer.
[FAN]	There is a problem with the fan or the fan drive circuit. Consult your dealer.
[INTAKE AIR TEMPERATURE]	The intake air temperature is high. The projector may be used in an environment where the temperature is high, such as near a heating appliance.
[OPTICS MODULE TEMPERATURE]	The temperature around the optics module inside the projector is high. The projector may be used in an environment where the temperature is high, such as near a heating appliance.
[EXHAUST AIR TEMPERATURE]	The exhaust air temperature is high. The projector may be used in an environment where the temperature is high, such as near a heating appliance. Or the air exhaust port may be blocked.
[LIGHT TEMPERATURE1]	The temperature of the light source is high. The projector may be used in an environment where the temperature is high, such as near a heating appliance.
[LIGHT TEMPERATURE2]	
[LIGHT STATUS]	The light source has failed to turn on. Consult your dealer.
[INTAKE AIR TEMP.SENSOR]	There is a problem with the sensor used to detect intake air temperature. Consult your dealer.
[OPTICS MODULE TEMP.SENSOR]	There is a problem with the sensor used to detect temperature inside the projector. Consult your dealer.
[EXHAUST AIR TEMP.SENSOR]	There is a problem with the sensor used to detect exhaust air temperature. Consult your dealer.
[LIGHT TEMP.1 SENSOR]	There is a problem with the temperature detection sensor of light source. Consult your dealer.
[LIGHT TEMP.2 SENSOR]	
[COLOR WHEEL]	There is a problem with the color wheel or the color wheel drive circuit. Consult your dealer.
[BRIGHTNESS SENSOR]	There is a problem with the luminance sensor. If problems persist even after switching on the power, consult your dealer.
[ANGLE SENSOR]	There is a problem with the angle sensor. Consult your dealer.
[ATM SENSOR]	There is a problem with the air pressure sensor. Consult your dealer.
[PHOSPHOR WHEEL]	There is a problem with the phosphor wheel or phosphor wheel drive circuit. Consult your dealer.

■ [WARNING] items

Item	Description
[LOW-TEMPERATURE]	The temperature around the optics module inside the projector is low. Image cannot be projected until the optics module becomes warm.
[INTAKE AIR TEMPERATURE]	The intake temperature is high. The projector may be used in an environment where the temperature is high, such as near a heating appliance.
[OPTICS MODULE TEMPERATURE]	The temperature around the optics module inside the projector is high. The projector may be used in an environment where the temperature is high, such as near a heating appliance.
[EXHAUST AIR TEMPERATURE]	The exhaust air temperature is high. The air exhaust port may be blocked.
[LIGHT TEMPERATURE1]	The temperature of the light source is high. The projector may be used in an environment where the temperature is high, such as near a heating appliance.
[LIGHT TEMPERATURE2]	
[BATTERY]	Battery replacement is required. Consult your dealer.

[Network status] page

Click [Status] → [Network status].

The current network setting status is displayed.

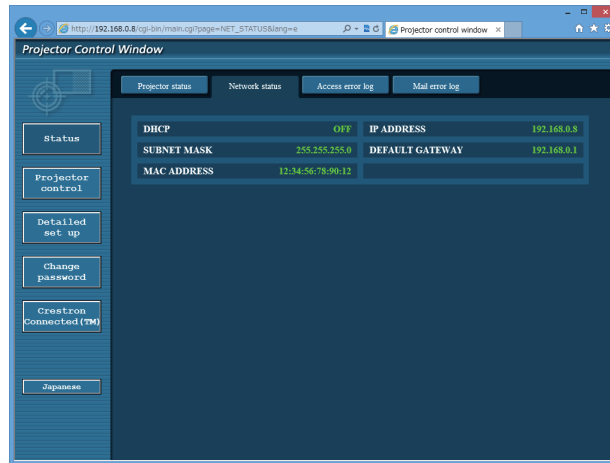

[Access error log] page

Click [Status] → [Access error log].

The error log on the web server is displayed such as access to the pages that do not exist or access with unauthorized user names or passwords.

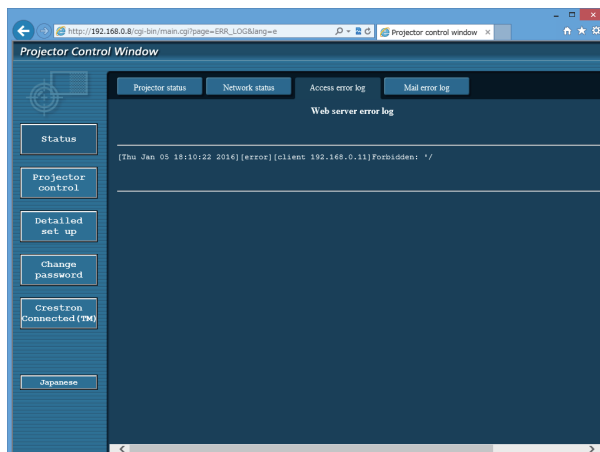

[Mail error log] page

Click [Status] → [Mail error log].

E-mail error log is displayed if periodic E-mail sending has failed.

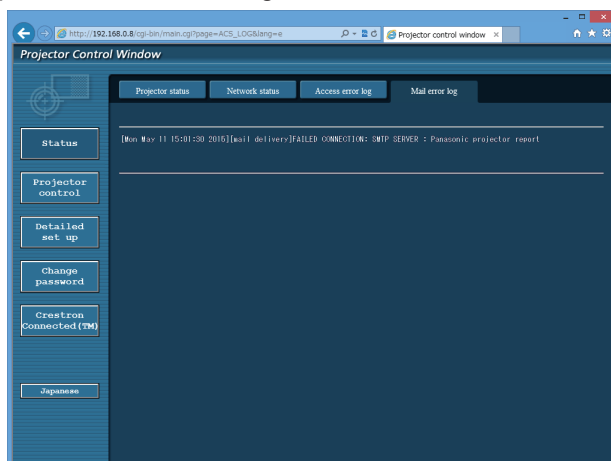

Note

- [Access error log] and [Mail error log] display the recent few thousand accesses/requests. All information may not be displayed when many accesses/requests are made at once.
- Logs in [Access error log] and [Mail error log] are deleted from the oldest when exceeding a certain amount.
- Check [Access error log] and [Mail error log] periodically.

[Basic control] page

Click [Projector control] → [Basic control].

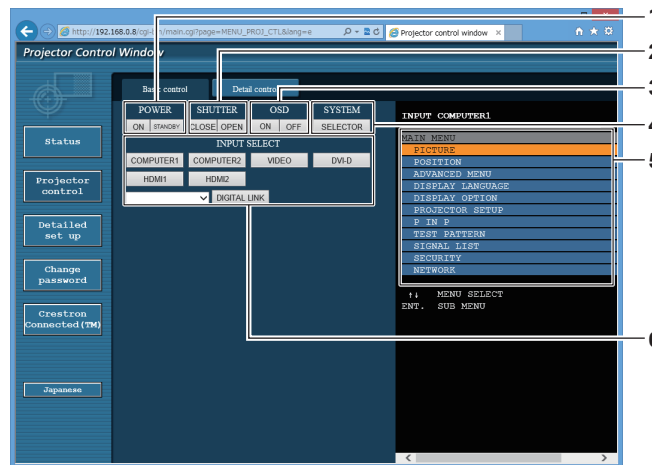

- | | |
|---|---|
| <p>1 [POWER]
Turns on/off the power.</p> <p>2 [SHUTTER]
Switches whether to use the shutter function (enabled (shutter: closed)/disabled (shutter: open)).</p> <p>3 [OSD]
Switches on (display)/off (hide) the on-screen display function.</p> | <p>4 [SYSTEM]
Switches the system method.</p> <p>5 On-screen display of the projector
Displays the same items as shown on the on-screen display of the projector. You can check or change the settings of the menus. It is displayed even if the on-screen display function is set to off (hide).</p> <p>6 [INPUT SELECT]
Switches the input signal.</p> |
|---|---|

[Detail control] page

Click [Projector control] → [Detail control].

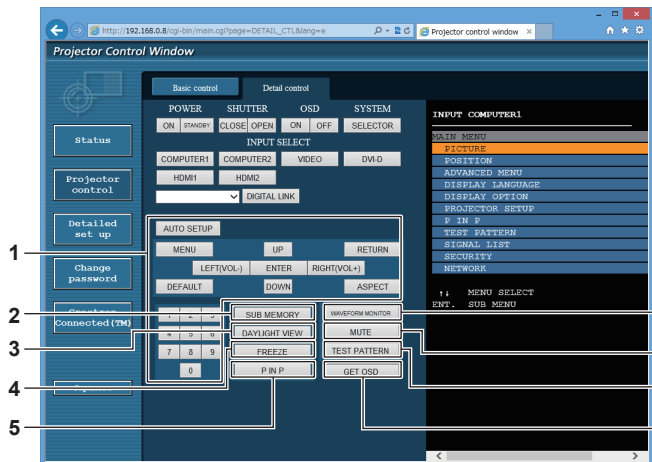

- | | |
|---|--|
| <p>1 Control of the projector
The projector is controlled by clicking the buttons in the same way as the buttons on the remote control. After control, the on-screen display of the projector at the right of the control page is updated.</p> <p>2 [SUB MEMORY]
Switches the sub memory.</p> <p>3 [DAYLIGHT VIEW]
Switches the day light view setting.</p> <p>4 [FREEZE]
Temporarily pauses the image.</p> | <p>5 [P IN P]
Switches the P IN P setting.</p> <p>6 [WAVEFORM MONITOR]
Displays the waveform of the input signal.</p> <p>7 [MUTE]
Switches whether to use the mute function.</p> <p>8 [TEST PATTERN]
Displays the test pattern.</p> <p>9 [GET OSD]
Updates the on-screen display of the projector at the right of the control page.</p> |
|---|--|

[Network config] page

Click [Detailed set up] → [Network config].

- Click [Network config] to display the **[CAUTION!]** screen.
- Click the [Next] button to display the current settings.
- Click the [Change] button to display the setting change screen.

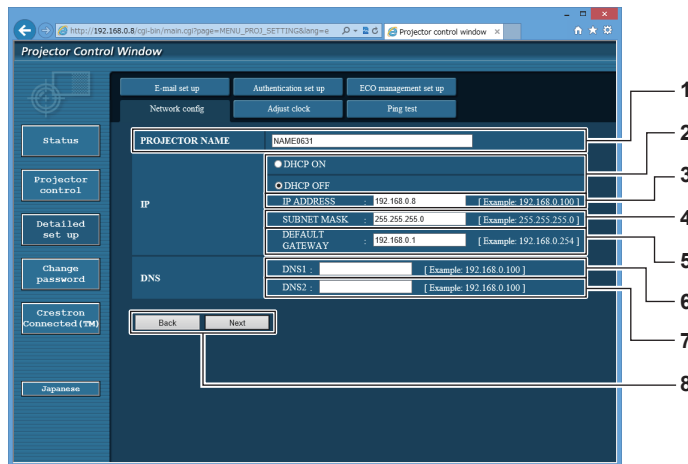

- | | |
|---|---|
| <p>1 [PROJECTOR NAME]
Enter the name of the projector. Enter the host name if it is required when using a DHCP server etc.</p> <p>2 [DHCP ON], [DHCP OFF]
To enable the DHCP client function, set to [DHCP ON].</p> <p>3 [IP ADDRESS]
Enter the IP address when not using a DHCP server.</p> <p>4 [SUBNET MASK]
Enter the subnet mask when not using a DHCP server.</p> <p>5 [DEFAULT GATEWAY]
Enter the default gateway address when not using a DHCP server.</p> | <p>6 [DNS1]
Enter the DNS1 server address.
Permissible characters for the entry of DNS1 server address (primary):
Numbers (0 - 9), period (.)
(Example: 192.168.0.253)</p> <p>7 [DNS2]
Enter the DNS2 server address.
Available characters for the entry of DNS2 server address (secondary):
Numbers (0 - 9), period (.)
(Example: 192.168.0.254)</p> <p>8 [Back], [Next]
Click the [Back] button to return to the original screen. Click the [Next] button to display the setting confirmation screen. Click the [Submit] button to update the setting.</p> |
|---|---|

Note

- When you use the “Forward” and “Back” functions of your browser, a warning message “Page has Expired” may appear. In that case, click [Network config] again since the following operation will not be guaranteed.
- The connection may be disconnected when the LAN setting is changed while connected with LAN.

[Adjust clock] page

Click [Detailed set up] → [Adjust clock].

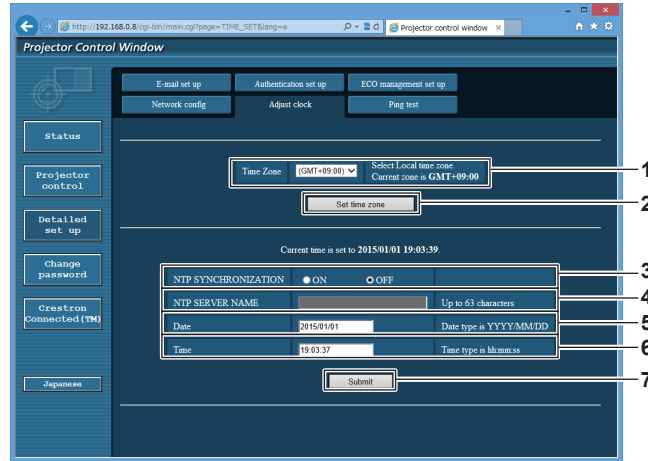

- | | |
|---|---|
| <p>1 [Time Zone]
Select the time zone.</p> <p>2 [Set time zone]
Updates the time zone setting.</p> <p>3 [NTP SYNCHRONIZATION]
Set [ON] when adjusting the date and time automatically.</p> <p>4 [NTP SERVER NAME]
Enter the IP address or server name of the NTP server when you set to adjust the date and time manually.
(To enter the server name, the DNS server needs to be set up.)</p> | <p>5 [Date]
Enter the date to be changed.</p> <p>6 [Time]
Enter the time to be changed.</p> <p>7 [Submit]
Updates the date and time settings.</p> |
|---|---|

Note

- The replacement of the battery inside the projector is required when the time goes out of alignment right after correcting the time. Consult your dealer.

[Ping test] page

Check whether the network is connected to the E-mail server, POP server, DNS server, etc.

Click [Detailed set up] → [Ping test].

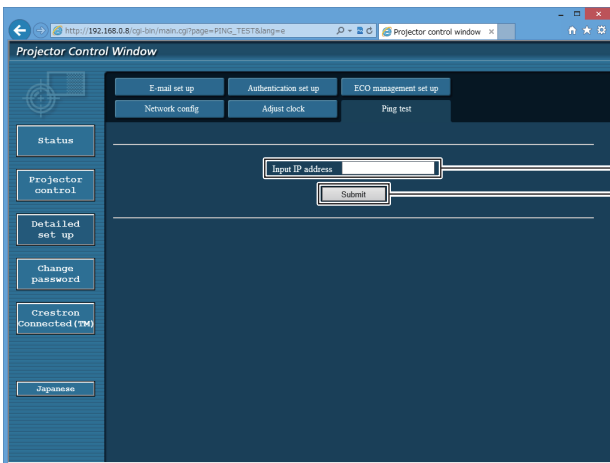

```
PING 192.168.0.8 (192.168.0.8): 56 data bytes
64 bytes from 192.168.0.8: seq=0 ttl=128 time=1 ms
64 bytes from 192.168.0.8: seq=1 ttl=128 time=1 ms
64 bytes from 192.168.0.8: seq=2 ttl=128 time=1 ms
64 bytes from 192.168.0.8: seq=3 ttl=128 time=1 ms

--- 192.168.0.8 ping statistics ---
4 packets transmitted, 4 packets received, 0% packet loss
round-trip min/avg/max = 1/1/1 ms
```

```
PING 192.168.0.15 (192.168.0.15): 56 data bytes

--- 192.168.0.15 ping statistics ---
4 packets transmitted, 0 packets received, 100% packet loss
```

- | | |
|--|--|
| <p>1 [Input IP address]
Enter the IP address of the server to be tested.</p> <p>2 [Submit]
Executes the connection test.</p> | <p>3 Example of display when the connection has succeeded</p> <p>4 Example of display when the connection has failed</p> |
|--|--|

[E-mail set up] page

When there is a problem or the runtime of the light source reaches the preset value, an E-mail can be sent to previously set E-mail addresses (up to two addresses).

Click [Detailed set up] → [E-mail set up].

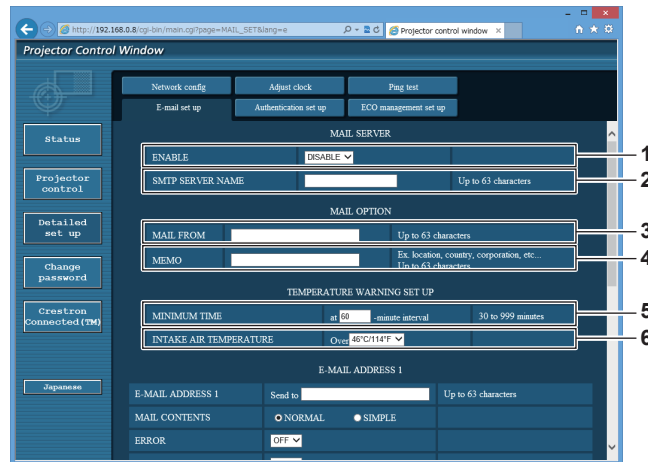

- 1 **[ENABLE]**
Select [ENABLE] to use the E-mail function.
- 2 **[SMTP SERVER NAME]**
Enter the IP address or the server name of the E-mail server (SMTP). To enter the server name, the DNS server needs to be set up.
- 3 **[MAIL FROM]**
Enter the E-mail address of the projector. (Up to 63 characters in single byte)
- 4 **[MEMO]**
Enter information such as the location of the projector that notifies the sender of the E-mail. (Up to 63 characters in single byte)

- 5 **[MINIMUM TIME]**
Change the minimum interval for the temperature warning E-mail. The default value is 60 minutes. In this case, another E-mail will not be sent for 60 minutes after sending the temperature warning E-mail even if it reaches the warning temperature.
- 6 **[INTAKE AIR TEMPERATURE]**
Change the temperature setting for the temperature warning mail. A temperature warning E-mail is sent when the temperature exceeds this value.

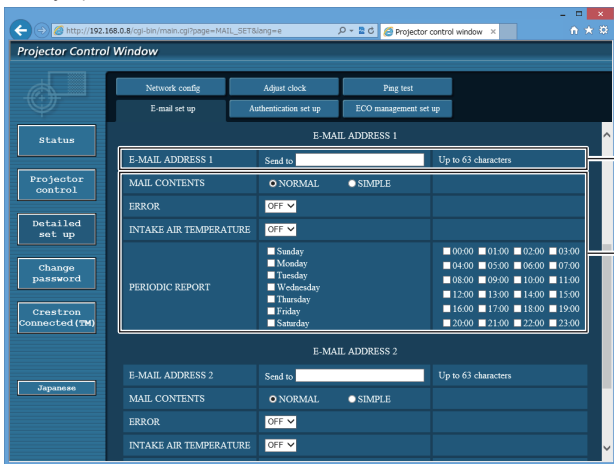

- 7 **[E-MAIL ADDRESS 1], [E-MAIL ADDRESS 2]**
Enter the E-mail address to be sent. Leave [E-MAIL ADDRESS 2] blank when two E-mail addresses are not to be used.

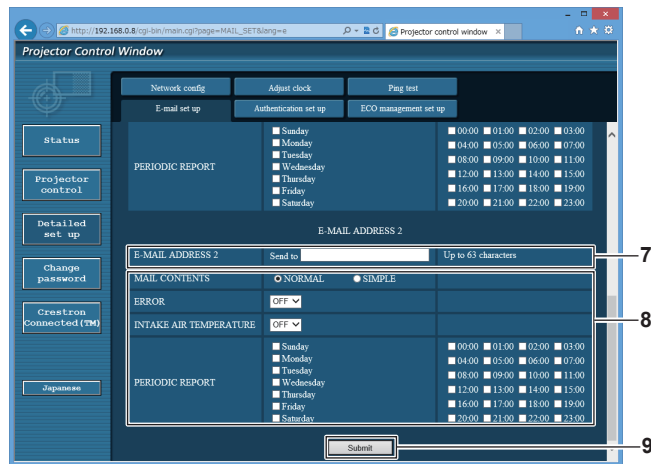

- 8 **Settings of the conditions to send E-mail**
Select the conditions to send E-mail.
[MAIL CONTENTS]:
Select either [NORMAL] or [SIMPLE].
[ERROR]:
Send an E-mail when an error occurred in the self-diagnosis.
[INTAKE AIR TEMPERATURE]:
Send an E-mail when the intake air temperature has reached the value set at the above field.
[PERIODIC REPORT]:
Place a check mark on this to send an E-mail periodically. It will be sent on the days and time with the check mark.
- 9 **[Submit]**
Update the settings.

[Authentication set up] page

Set the authentication items when POP authentication or SMTP authentication is necessary to send an E-mail. Click [Detailed set up] → [Authentication set up].

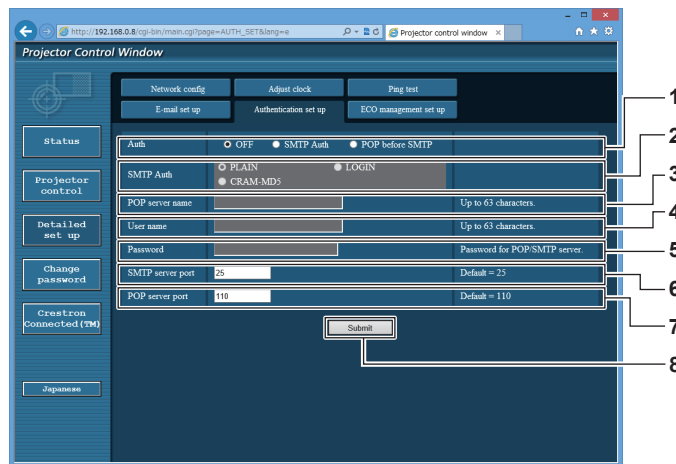

- | | |
|--|---|
| <p>1 [Auth]
Select the authentication method specified by your Internet service provider.</p> <p>2 [SMTP Auth]
Set when the SMTP authentication is selected.</p> <p>3 [POP server name]
Enter the POP server name.
Allowed characters:
Alphanumerics (A - Z, a - z, 0 - 9)
Minus sign (-) and period (.)</p> <p>4 [User name]
Enter the user name for the POP server or the SMTP server.</p> | <p>5 [Password]
Enter the password for the POP server or the SMTP server.</p> <p>6 [SMTP server port]
Enter the port number of the SMTP server.
(Normally 25)</p> <p>7 [POP server port]
Enter the port number of the POP server.
(Normally 110)</p> <p>8 [Submit]
Update the settings.</p> |
|--|---|

[ECO management set up] page

Settings related to the ECO management function of the projector can be made. Click [Detailed set up] → [ECO management set up].

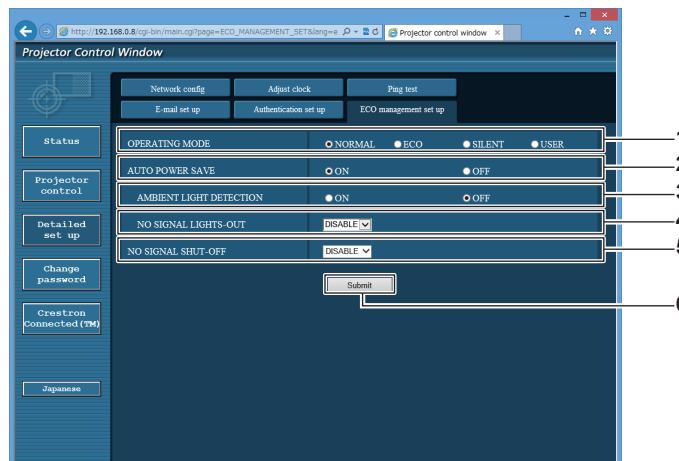

- | | |
|--|--|
| <p>1 [OPERATING MODE]
Select the [OPERATING MODE] setting.</p> <p>2 [AUTO POWER SAVE]
Set [ON] when setting [AMBIENT LIGHT DETECTION] and [NO SIGNAL LIGHT-OUT].</p> <p>3 [AMBIENT LIGHT DETECTION]
Enables ([ON])/disables ([OFF]) the ambient light detection function.</p> | <p>4 [NO SIGNAL LIGHT-OUT]
Select the duration until the light source is turned off when the no signal light-out function is used.</p> <p>5 [NO SIGNAL SHUT-OFF]
Select the duration until the standby mode is entered when the no signal shut-off function is used.</p> <p>6 [Submit]
Updates the setting.</p> |
|--|--|

Note

- For details of each setting item, refer to the [PROJECTOR SETUP] menu of the projector → [ECO MANAGEMENT].

Contents of E-mail sent

Example of the E-mail sent when E-mail is set

The following E-mail is sent when the E-mail settings have been established.

```

=== Panasonic projector report(CONFIGURE) ===
Projector Type      : RZ570
Serial No          : 123456789012

---- E-mail setup data ----
TEMPERATURE WARNING SETUP
MINIMUM TIME      at [ 60 ] minutes interval
INTAKE AIR TEMPERATURE Over [ 31 degC / 87 degF ]

ERROR [ ON ]
INTAKE AIR TEMPERATURE [ ON ]
PERIODIC REPORT
Sunday [ ON ] Monday [ ON ] Tuesday [ ON ] Wednesday [ ON ]
Thursday [ ON ] Friday [ ON ] Saturday [ ON ]

00:00 [ ON ] 01:00 [ ON ] 02:00 [ ON ] 03:00 [ ON ]
04:00 [ ON ] 05:00 [ ON ] 06:00 [ ON ] 07:00 [ ON ]
08:00 [ ON ] 09:00 [ ON ] 10:00 [ ON ] 11:00 [ ON ]
12:00 [ ON ] 13:00 [ ON ] 14:00 [ ON ] 15:00 [ ON ]
16:00 [ ON ] 17:00 [ ON ] 18:00 [ ON ] 19:00 [ ON ]
20:00 [ ON ] 21:00 [ ON ] 22:00 [ ON ] 23:00 [ ON ]

---- check system ----
MAIN CPU BUS [ OK ]
FAN [ OK ]
INTAKE AIR TEMPERATURE [ OK ]
OPTICS MODULE TEMPERATURE [ OK ]
EXHAUST AIR TEMPERATURE [ OK ]
LIGHT TEMPERATURE1 [ OK ]
LIGHT TEMPERATURE2 [ OK ]
LIGHT STATUS [ OK ]
INTAKE AIR TEMP.SENSOR [ OK ]
OPTICS MODULE TEMP.SENSOR [ OK ]
EXHAUST AIR TEMP.SENSOR [ OK ]
LIGHT TEMP. 1 SENSOR [ OK ]
LIGHT TEMP. 2 SENSOR [ OK ]
BATTERY [ OK ]
COLOR WHEEL [ OK ]
BRIGHTNESS SENSOR [ OK ]
ANGLE SENSOR [ OK ]
ATM SENSOR [ OK ]
PHOSPHOR WHEEL [ OK ]
(Error code 00 00 00 00 00 00 00 00 00 00 00 00 00 00 00)

Intake air temperature : 26 degC / 78 degF
Optics module temperature : 35 degC / 95 degF
Exhaust air temperature : 30 degC / 86 degF
Light temperature1 : 44 degC / 111 degF
Light temperature2 : 33 degC / 91 degF
PROJECTOR RUNTIME 16 H
POWER ON 72 times
LIGHT RUNTIME 16 H
LIGHT ON 78 times

----- Current status -----
MAIN VERSION 1.00
SUB VERSION 1.00
LIGHT STATUS LIGHT=ON
INPUT COMPUTER1
SIGNAL NAME 1024x768
SIGNAL FREQUENCY 48.22kHz / 59.85Hz

---- Wired Network configuration ----
DHCP Client OFF
IP address 192.168.0.8
MAC address 12:34:56:78:90:12

Mon Jan 01 12:34:56 20XX

---- Memo ----

```

Example of the E-mail sent for an error

The following E-mail is sent when an error has occurred.

```
=== Panasonic projector report(ERROR) ===
Projector Type      : RZ570
Serial No          : 123456789012

---- check system ----
MAIN CPU BUS       [ OK ]
FAN                [ OK ]
INTAKE AIR TEMPERATURE [ OK ]
OPTICS MODULE TEMPERATURE [ OK ]
EXHAUST AIR TEMPERATURE [ OK ]
LIGHT TEMPERATURE1 [ OK ]
LIGHT TEMPERATURE2 [ OK ]
LIGHT STATUS       [ OK ]
INTAKE AIR TEMP.SENSOR [ OK ]
OPTICS MODULE TEMP.SENSOR [ OK ]
EXHAUST AIR TEMP.SENSOR [ OK ]
LIGHT TEMP. 1 SENSOR [ OK ]
LIGHT TEMP. 2 SENSOR [ OK ]
BATTERY            [ OK ]
COLOR WHEEL        [ OK ]
BRIGHTNESS SENSOR [ FAILED ]
ANGLE SENSOR       [ OK ]
ATM SENSOR         [ OK ]
PHOSPHOR WHEEL     [ OK ]
(Error code 00 00 00 00 00 00 00 00 00 00 80 00 00)

Intake air temperature : 28 degC / 82 degF
Optics module temperature : 35 degC / 95 degF
Exhaust air temperature : 29 degC / 84 degF
Light temperature1      : 44 degC / 111 degF
Light temperature2      : 28 degC / 82 degF
PROJECTOR RUNTIME       16 H
POWER ON                 72 times
LIGHT RUNTIME           16 H
LIGHT ON                 78 times

----- Current status -----
MAIN VERSION             1.00
SUB VERSION              1.00
LIGHT STATUS             LIGHT=ON
INPUT                   COMPUTER1
SIGNAL NAME              1024x768
SIGNAL FREQUENCY         48.22kHz / 59.85Hz

---- Wired Network configuration ----
DHCP Client              OFF
IP address               192.168.0.8
MAC address              12:34:56:78:90:12

Mon Jan 01 12:34:56 20XX

----- Memo -----
```

[Change password] page

Click [Change password].

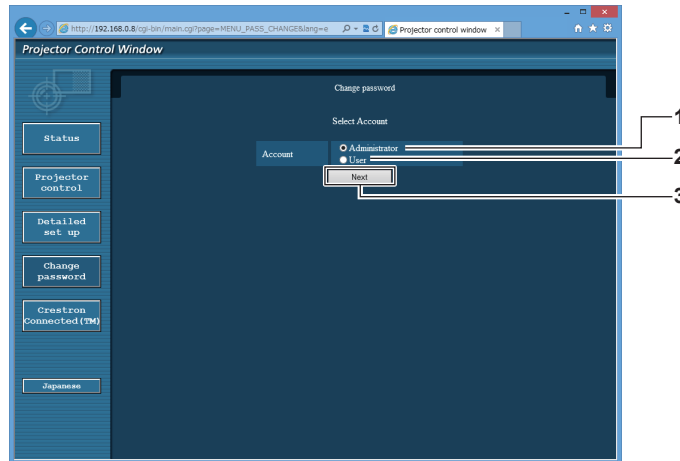

- 1 **[Administrator]**
Used to change the setting of the [Administrator].
- 2 **[User]**
Used to change the setting of the [User].
- 3 **[Next]**
Used to change the setting of the password.

[Administrator] account

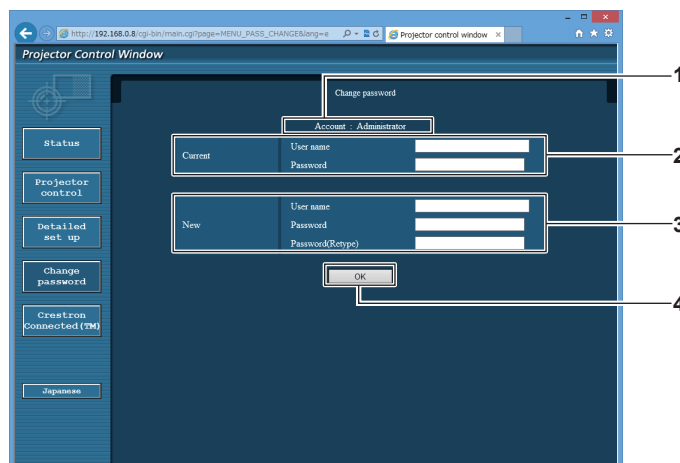

- 1 **[Account]**
Displays the account to change.
- 2 **[Current]**
[User name]:
Enter the user name before the change.
[Password]:
Enter the current password.
- 3 **[New]**
[User name]:
Enter the desired new user name. (Up to 16 characters in single byte)
[Password]:
Enter the desired new password. (Up to 16 characters in single byte)
[Password(Retyp)]:
Enter the desired new password again.
- 4 **[OK]**
Determines the change of password.

[User] account

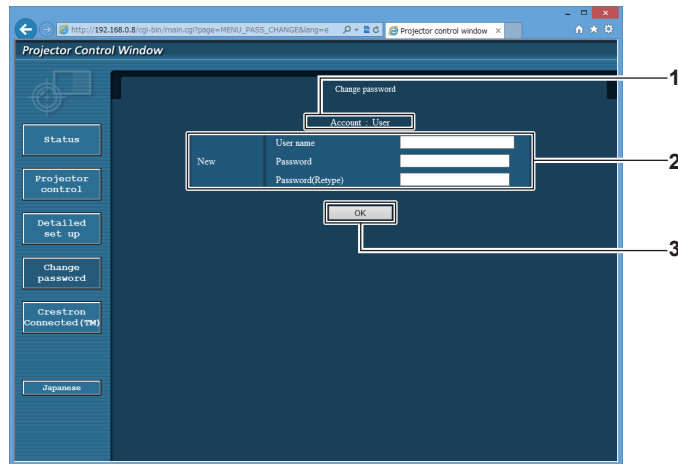

- | | |
|--|---|
| <p>1 [Account]
Displays the account to change.</p> <p>2 [New]
[User name]:
Enter the desired new user name. (Up to 16 characters in single byte)
[Password]:
Enter the desired new password. (Up to 16 characters in single byte)
[Password(Retype)]:
Enter the desired new password again.</p> | <p>3 [OK]
Determines the change of password.</p> |
|--|---|

[Change password] (For user rights)

Only the change of password is enabled under the user rights.

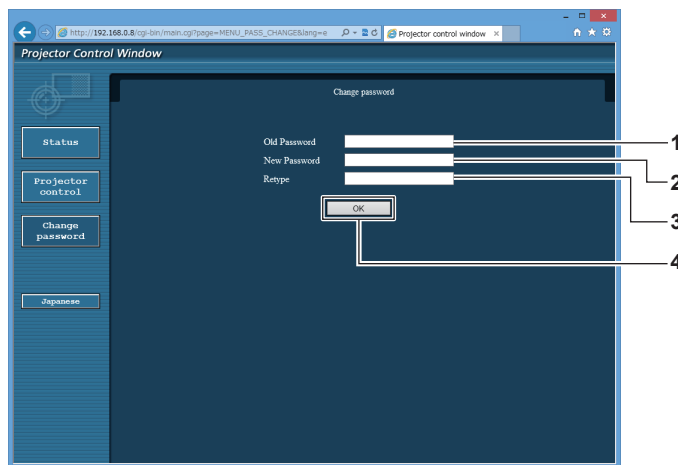

- | | |
|--|--|
| <p>1 [Old Password]
Enter the current password.</p> <p>2 [New Password]
Enter the desired new password. (Up to 16 characters in single byte)</p> | <p>3 [Retype]
Enter the desired new password again.</p> <p>4 [OK]
Determines the change of password.</p> |
|--|--|

Note

- To change the account of the administrator, you must enter the [User name] and [Password] in [Current].

[Crestron Connected(TM)] page

The projector can be monitored/controlled with Crestron Connected™.

It is necessary to access with the administrator rights to start the operation screen of Crestron Connected™ from the web control screen. (The [Crestron Connected(TM)] button is not displayed in the web control screen with the user rights.)

The operation page of Crestron Connected™ is displayed by clicking [Crestron Connected(TM)].

It is not displayed if Adobe Flash Player is not installed on your computer, or the browser you use does not support Flash. In such a case, click [Back] in the operation page to go back to the previous page.

Operation page

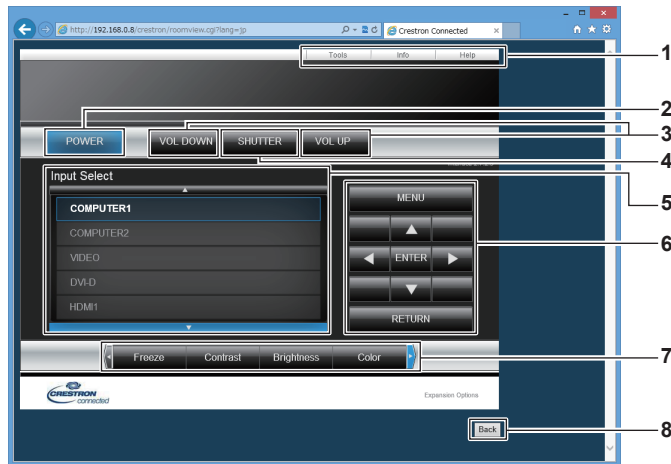

- | | |
|---|---|
| <p>1 [Tools], [Info], [Help]
Tabs for selecting the setting, information, or help page of the projector.</p> <p>2 [POWER]
Turns on/off the power.</p> <p>3 [VOL DOWN], [VOL UP]
Adjusts the volume.</p> <p>4 [SHUTTER]
Switches whether to use the shutter function (enabled (shutter: closed)/disabled (shutter: open)).</p> | <p>5 [Input Select]
Controls input selection.
Not available when the power of the projector is turned off.</p> <p>6 Menu screen control buttons
Navigates the menu screen.</p> <p>7 Freeze/image quality adjustment
Controls items related to freeze/image quality.</p> <p>8 [Back]
Returns to the previous page.</p> |
|---|---|

[Tools] page

Click [Tools] in the operation page.

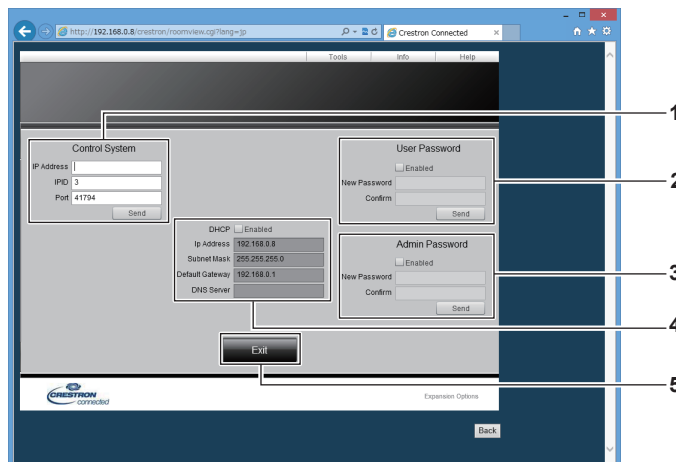

- | | |
|---|--|
| <p>1 [Control System]
Set the information required for communicating with the controller to be connected with the projector.</p> <p>2 [User Password]
Set the user rights password for the operation page of Crestron Connected™.</p> <p>3 [Admin Password]
Set the administrator rights password for the operation page of Crestron Connected™.</p> | <p>4 Network status
Displays the settings of wired LAN.
[DHCP]
Displays the current setting.
[Ip Address]
Displays the current setting.
[Subnet Mask]
Displays the current setting.
[Default Gateway]
Displays the current setting.
[DNS Server]
Displays the current setting.</p> <p>5 [Exit]
Returns to the operation page.</p> |
|---|--|

[Info] page

Click [Info] in the operation page.

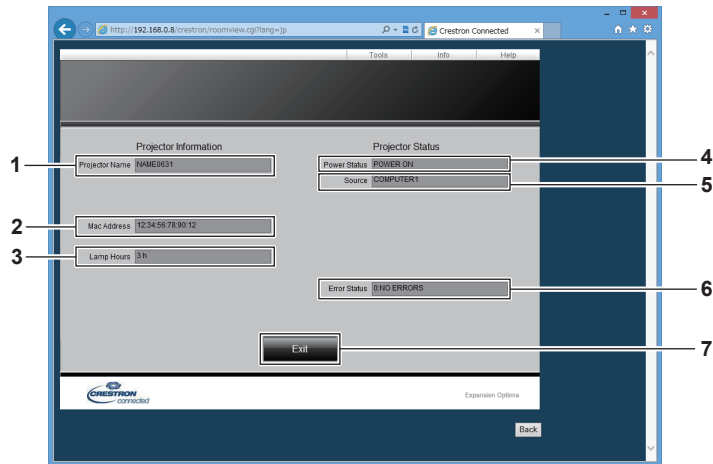

- | | |
|---|---|
| <p>1 [Projector Name]
Displays the projector name.</p> <p>2 [Mac Address]
Displays the MAC address.</p> <p>3 [Lamp Hours]
Displays the runtime of the light source.</p> <p>4 [Power Status]
Displays the status of the power.</p> | <p>5 [Source]
Displays the selected input.</p> <p>6 [Error Status]
Displays the error status.</p> <p>7 [Exit]
Returns to the operation page.</p> |
|---|---|

[Help] page

Click [Help] in the operation page.
The [Help Desk] window is displayed.

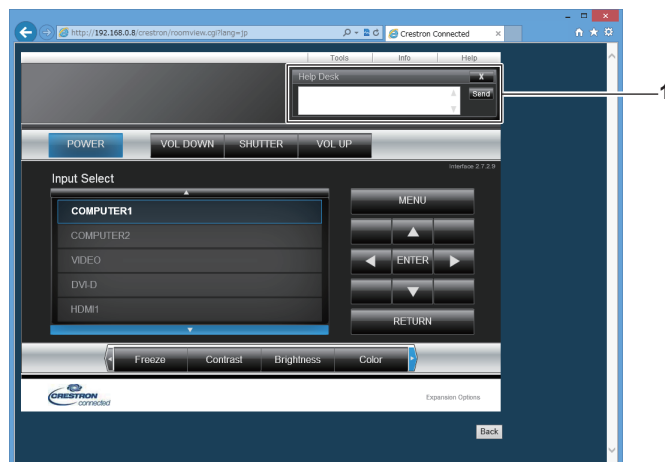

- 1 **[Help Desk]**
A message can be sent/received with the administrator using the Crestron Connected™.

Chapter 6 Maintenance

This chapter describes inspection methods when there are problems, and maintenance methods.

Light source/temperature indicators

When an indicator lights up

If a problem occurs inside the projector, the light source indicator <LIGHT> or the temperature indicator <TEMP> will inform you by lighting or blinking. Check the status of the indicators and take following measures.

Attention

- When switching off the projector to deal with problems, make sure to follow the procedure in “Switching off the projector” (➔ page 46).

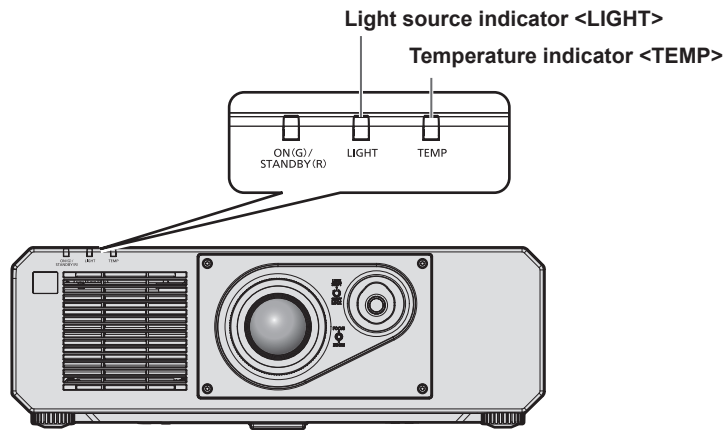

Light source indicator <LIGHT>

Indicator status	Lighting in red	Blinking in red (2 times)	Blinking in red (3 times)
Status	Some of the elements of the light source are defective and the light output has decreased.	The light source does not light up, or the light source turns off while the projector is in use.	
Cause	—		
Solution	<ul style="list-style-type: none"> Turn the <MAIN POWER> switch to <OFF> (➔ page 46), and turn on the power again. 		

Note

- If the light source indicator <LIGHT> continues to light or blink even after the measure is taken, set the <MAIN POWER> switch to <OFF>, and ask your dealer for repair.
- The light source indicator <LIGHT> lights in green while the projector is in projection mode if there is no notification by lighting or blinking in red.

Temperature indicator <TEMP>

Indicator status	Lighting in red		Blinking in red (2 times)	Blinking in red (3 times)
Status	Warm-up status	Internal temperature is high (warning).	Internal temperature is high (standby status).	The cooling fan has stopped.
Cause	<ul style="list-style-type: none"> Did you turn on the power when the temperature was low (around 0 °C (32 °F))? 	<ul style="list-style-type: none"> Is the air intake/exhaust port blocked? Is the room temperature high? 		—
Solution	<ul style="list-style-type: none"> Wait at least five minutes in the current status. Use the projector in an appropriate operating environment temperature*1. 	<ul style="list-style-type: none"> Remove any objects that are blocking the air intake/exhaust port. Use the projector in an appropriate operating environment temperature*1. Do not use the projector at an altitude of 4 200 m (13 780') or higher above sea level*2. 		<ul style="list-style-type: none"> Turn the <MAIN POWER> switch to <OFF> (➡ page 46), and consult your dealer.

*1 The operating environment temperature of the projector differs depending on the altitude or the setting of the [PROJECTOR SETUP] menu → [ECO MANAGEMENT] → [OPERATING MODE]. Refer to “Operating environment temperature” (➡ page 170) for details.

*2 When the [PROJECTOR SETUP] menu → [ECO MANAGEMENT] → [OPERATING MODE] is set to [ECO] or [SILENT], the projector cannot be used at an altitude of 2 700 m (8 858') or higher above sea level.

Note

- If the temperature indicator <TEMP> is still lit or blinking after taking the measures, ask your dealer for repair.

Maintenance

Before maintaining the projector

- Make sure to turn off the power before performing the maintenance of the projector. (➔ pages 40, 46)
- When switching off the projector, make sure to follow the procedures in “Switching off the projector” (➔ page 46).

Maintenance

Outer case

Wipe off dirt and dust with a soft, dry cloth.

- If the dirt is persistent, soak the cloth with water and wring it thoroughly before wiping. Dry off the projector with a dry cloth.
- Do not use benzene, thinner, or rubbing alcohol, other solvents, or household cleaners. Doing so may deteriorate the outer case.
- When using chemically treated dust cloths, follow the instructions written on its packaging.

Lens front surface

Wipe off dirt and dust from the front surface of the lens with a soft clean cloth.

- Do not use a cloth that is fluffy, dusty, or soaked with oil/water.
- Since the lens is fragile, do not use excessive force when wiping the lens.

Attention

- The lens is made of glass. Impacts or excessive force when wiping may scratch its surface. Handle with care.

Note

- Dust may accumulate around the air intake/exhaust port depending on the environment and operating condition when used in an environment with excessive dust. This may adversely affect the ventilation, cooling, and heat dissipation inside the projector, thus causing reduced brightness.

Troubleshooting

Review the following points. For details, see the corresponding pages.

Problems	Points to be checked	Page
Power does not turn on.	• Is the power plug firmly inserted into the outlet?	—
	• Is the <MAIN POWER> switch set to <OFF>?	46
	• Is the wall outlet supplying electricity?	—
	• Have the circuit breakers tripped?	—
	• Is the light source indicator <LIGHT> blinking?	148
	• Is the temperature indicator <TEMP> lit or blinking?	149
No image appears.	• Are connections to external devices correctly performed?	34
	• Is the input selection setting correct?	47
	• Is the [BRIGHTNESS] adjustment setting at a minimum?	62
	• Is the external device that is connected to the projector working properly?	—
	• Is the shutter function in use?	50, 92
	• If the power indicator <ON (G)/STANDBY (R)> is blinking in red, consult your dealer.	—
Image is fuzzy.	• Is the lens focus set correctly?	48
	• Is the projection distance appropriate?	31
	• Is the lens dirty?	20
	• Is the projector installed perpendicular to the screen?	—
Color is pale or grayish.	• Are [COLOR] and [TINT] adjusted correctly?	63
	• Is the external device connected to the projector adjusted correctly?	34
	• Is the computer cable damaged?	—
Audio is not output.	• Is the external device connected correctly to the audio input terminal?	27
	• Is the mute function used?	50, 108
	• Is [AUDIO IN SELECT] in [AUDIO SETTING] correctly set?	108
Remote control does not respond.	• Are the batteries depleted?	—
	• Is the polarity of the batteries set correctly?	28
	• Are there any obstructions between the remote control and the remote control signal receiver of the projector?	24
	• Is the remote control being used beyond its effective operation range?	24
	• Are other forms of light, such as fluorescent light, affecting the projection?	24
	• Is the [REMOTE CONTROL] setting in [CONTROL DEVICE SETUP] set to [DISABLE]?	119
	• Is the ID number setting operation correct?	54
Menu screen does not appear.	• Is the on-screen display function turned off (hidden)?	51
Buttons on the control panel do not operate.	• Is the [CONTROL PANEL] setting in [CONTROL DEVICE SETUP] set to [DISABLE]?	119
Image does not display correctly.	• Is [SYSTEM SELECTOR] set properly?	66
	• Is [COMPUTER IN/OUT] set correctly?	82
	• Is there a problem with the video tape or other image sources?	—
	• Is a signal which is not compatible with the projector being input?	167
Image from a computer does not appear.	• Is the cable too long? (For D-Sub cables, the cable length should be 10 m (32'10") or shorter.)	—
	• Is the external video output on the laptop computer set correctly? (Ex.: The external output settings may be switched by pressing the "Fn" + "F3" keys or the "Fn" + "F10" keys simultaneously. This will differ depending on the model of the computer. Refer to the user manual provided with your computer.)	—
Image output from DVI-D of the computer does not appear.	• Is [EDID SELECT] in [DVI-D IN] set to [EDID3] or [EDID2:PC]?	84
	• It may improve by updating the graphic accelerator driver of the computer to the latest version.	—
	• It may improve by performing the [EDID SELECT] setting in [DVI-D IN], and then rebooting the computer.	84
Video from HDMI compatible device does not appear or it appears jumbled.	• Is the HDMI cable connected securely?	34
	• Turn the power of the projector and the external device off and on.	—
	• Is a signal which is not compatible with the projector being input?	167

Chapter 6 Maintenance — Troubleshooting

Problems	Points to be checked	Page
Cannot control the projector with Art-Net.	• Are the connections between the twisted-pair-cable transmitter and an external device, and between the twisted-pair-cable transmitter and projector correctly done?	—
	• Is [Art-Net SETUP] set to other than [OFF]?	124
	• Are [NET], [SUB NET], [UNIVERSE], and [START ADDRESS] set correctly?	124
The DIGITAL LINK input image is not displayed.	• Is the cable compatible to the condition of the projector used?	37
	• Are the connections between the twisted-pair-cable transmitter and an external device, and between the twisted-pair-cable transmitter and projector correctly done?	—
	• Is [DIGITAL LINK MODE] set to [AUTO] or [DIGITAL LINK]? Is it set to [ETHERNET]?	122
	• Is a signal which is not compatible with a twisted-pair-cable transmitter being input?	—

Attention

- If problems persist even after checking the preceding points, consult your dealer.

[SELF TEST] indications

[SELF TEST] can be checked in the [PROJECTOR SETUP] menu → [STATUS] → [SELF TEST].

The following list shows the alphanumeric symbol that is displayed when an error or a warning has occurred and its details. Confirm “Action number”, and follow the measure in “Measure for error and warning” (➔ page 154).

The input supply voltage is displayed only with the numeric value.

Error/warning display	Details	Action number
U11	Intake temperature warning	1
U12	Optical module temperature warning	1
U13	Exhaust air temperature warning	1
U14	Low temperature warning	2
U16	Temperature warning for the front block of the light source (on the lens side)	1
U18	Temperature warning for the rear block of the light source (on the air exhaust port side)	1
U21	Intake temperature error	1
U22	Optical module temperature error	1
U23	Exhaust air temperature error	1
U24	Low temperature error	2
U25	Temperature error for the front block of the light source (on the lens side)	1
U27	Temperature error for the rear block of the light source (on the air exhaust port side)	1
H01	Battery replacement for the internal clock	3
H11	Intake air temperature sensor error	4
H12	Optical module temperature sensor error	4
H13	Exhaust air temperature sensor error	4
H14	Temperature sensor error for the front block of the light source (on the lens side)	4
H16	Temperature sensor error for the rear block of the light source (on the air exhaust port side)	4
F15	Luminance sensor warning	4
F16	Angle sensor error	4
F18	Air pressure sensor error	4
F50	Heat pipe fan 1 warning	4
F51	Heat pipe fan 2 warning	4
F52	DMD fan warning	4
F53	Circuit intake fan warning	4
F54	Exhaust fan 1 warning	4
F55	Exhaust fan 2 warning	4
F56	Center fan warning	4
F61	Light source driver communication error	4
F85	Color wheel error (FM)	4
F86	Color wheel error (FPGA)	4
F90	FPGA configuration error	4
F97	Geometric adjustment board communication error	4
F99	Internal error	4
FE1	Heat pipe fan 1 error	4
FE2	Heat pipe fan 2 error	4
FE3	DMD fan error	4
FE4	Circuit intake fan error	4
FE5	Exhaust fan 1 error	4
FE6	Exhaust fan 2 error	4
FE7	Center fan error	4
FH0	PW ERROR (FM/SUB)	4
FL1	Light source unit error	5
FL5	Light source bank 1 warning	4
FL6	Light source bank 2 warning	4
FL7	Light source bank 3 warning	4
FL8	Light source bank 4 warning	4

Note

- The self-diagnosis display and the details of the malfunction may be different.

- For errors and warnings that are not described in the table, consult your dealer.

■ Measure for error and warning

Action number	Measure
1	The operating environment temperature is too high. Use the projector in an appropriate operating environment temperature*1.
2	The operating environment temperature is too low. Use the projector in an appropriate operating environment temperature*1.
3	Battery replacement is required. Consult your dealer.
4	If the display does not clear after switching the main power off and on, consult your dealer.
5	The light source has failed to turn on. If the light source does not light up after turning the power off and on, consult your dealer.

*1 The operating environment temperature of the projector differs depending on the altitude or the setting of the [PROJECTOR SETUP] menu → [ECO MANAGEMENT] → [OPERATING MODE]. Refer to "Operating environment temperature" (➔ page 170) for details.

Chapter 7 Appendix

This chapter describes specifications and after-sales service for the projector.

Technical information

PJLink protocol

The network function of this projector supports the PJLink class 1, and the PJLink protocol can be used to perform projector setting and projector status query operations from a computer.

Control commands

The following table lists the PJLink protocol commands that can be used to control the projector.

• x characters in tables are non-specific characters.

Command	Control details	Parameter/response string	Remark		
POWR	Power supply control	0 1	Standby Power on		
POWR?	Power supply status query	0 1 2 3	Standby Power on Preparing for switching off the projector Warm-up		
INPT	Input selection	11 12 21	COMPUTER1 COMPUTER2 VIDEO		
INPT?	Input selection query	31 32 33 36	DVI-D HDMI1 DIGITAL LINK HDMI2		
AVMT	Shutter control/audio output control	10 11 20	Shutter function disabled (shutter: open), mute function disabled Shutter function enabled (shutter: closed), mute function disabled Shutter function disabled (shutter: open), mute function disabled		
AVMT?	Shutter status query/ audio output status query	21 30 31	Shutter function disabled (shutter: open), mute function enabled (muted) Shutter function disabled (shutter: open), mute function disabled Shutter function enabled (shutter: closed), mute function enabled (muted)		
ERST?	Error status query	xxxxxx	1st byte	Indicates fan errors, and returns 0 or 2.	<ul style="list-style-type: none"> • 0 = No error is detected • 1 = Warning • 2 = Error
			2nd byte	Indicates light source errors, and returns 0 or 2.	
			3rd byte	Indicates temperature errors, and returns 0 - 2.	
			4th byte	Returns 0.	
			5th byte	Returns 0.	
			6th byte	Indicates other errors, and returns 0 - 2.	
LAMP?	Light source status query	xxxxxx	1st number (1 - 5 digits): Light source runtime 2nd number: 0 = Light source off, 1 = Light source on		
INST?	Input selection list query	11 12 21 31 32 33 36	—		
NAME?	Projector name query	xxxxx	Returns the name set in the [NETWORK] menu → [NETWORK SETUP] → [PROJECTOR NAME].		
INF1?	Manufacturer name query	Panasonic	Returns manufacturer name.		
INF2?	Model name query	RZ570	Returns model name.		
INF0?	Other information queries	xxxxx	Returns the main version of the firmware.		
CLSS?	Class information query	1	Returns class for PJLink.		

PJLink security authentication

The password used for PJLink is the same as that of the password set for web control.

When using the projector without security authentication, do not set a password for web control.

- For specifications related to PJLink, visit the website of Japan Business Machine and Information System Industries Association.

URL <http://pjlink.jbmia.or.jp/english/>

Using Art-Net function

Since the network function of the projector supports the Art-Net function, you can control the projector settings with the DMX controller and application software using the Art-Net protocol.

Channel definition

The following table lists the channel definitions used for controlling the projector with the Art-Net function.

Channel settings can be switched using the [NETWORK] menu → [Art-Net CHANNEL SETTING] (➡ page 125).

The control details assigned to each channel are listed in the following table.

- Channel assignment for [USER] is in factory default setting. Assignment can be changed.

Channel	Control details		
	[2]	[USER]	[1]
CHANNEL1	LIGHT OUTPUT	LIGHT OUTPUT	SHUTTER
CHANNEL2	INPUT SELECT	INPUT SELECT	INPUT SELECT
CHANNEL3	NONE	NONE	NONE
CHANNEL4	NONE	NONE	NONE
CHANNEL5	NONE	NONE	POWER
CHANNEL6	NONE	NONE	LIGHT OUTPUT
CHANNEL7	NONE	NONE	ENABLE / DISABLE
CHANNEL8	POWER	POWER	FADE-IN
CHANNEL9	SCREEN ADJUSTMENT	SCREEN ADJUSTMENT	FADE-OUT
CHANNEL10	NONE	NONE	NONE
CHANNEL11	ENABLE / DISABLE	ENABLE / DISABLE	SCREEN ADJUSTMENT
CHANNEL12	NONE	NONE	NONE

Control details

■ LIGHT OUTPUT

This can be set in 256 steps between 100 % and 0 %.

Performance	Parameter	Default value
100 %	0	0
...	...	
0 %	255	

■ INPUT SELECT (when [Art-Net CHANNEL SETTING] is set to [1])

Performance	Parameter	Default value
No operation	0-7	0
COMPUTER1	8-15	
COMPUTER2	16-23	
VIDEO	24-31	
DVI-D	32-39	
HDMI1	40-47	
DIGITAL LINK	48-55	
No operation	56-127	
Execute P IN P, USER1	128-135	
Execute P IN P, USER2	136-143	
Execute P IN P, USER3	144-151	
No operation	152-255	

■ INPUT SELECT (when [Art-Net CHANNEL SETTING] is set to [2] or [USER])

Performance	Parameter	Default value
No operation	0-7	0
COMPUTER1	8-15	
COMPUTER2	16-23	
DVI-D	24-31	
HDMI1	32-39	
DIGITAL LINK	40-47	
No operation	48-63	
VIDEO	64-71	
HDMI2	72-79	
No operation	80-119	
P IN P OFF	120-127	
Execute P IN P, USER1	128-135	
Execute P IN P, USER2	136-143	
Execute P IN P, USER3	144-151	
No operation	152-255	

■ POWER

Performance	Parameter	Default value
Standby	0-63	128
No operation	64-191	
Power on	192-255	

■ SHUTTER

Performance	Parameter	Default value
SHUTTER: Open, mute clear	0-63	128
No operation	64-191	
SHUTTER: Closed, mute	192-255	

■ FADE-IN, FADE-OUT (when [Art-Net CHANNEL SETTING] is set to [1])

Operate together with SHUTTER.

Performance	Parameter	Default value
OFF	0-15	255
0.5s	16-31	
1.0s	32-47	
1.5s	48-63	
2.0s	64-79	
2.5s	80-95	
3.0s	96-111	
3.5s	112-127	
4.0s	128-143	
5.0s	144-159	
7.0s	160-175	
10.0s	176-191	
No operation	192-255	

■ SCREEN ADJUSTMENT

Performance	Parameter	Default value
OFF	0-15	255
KEystone	16-31	
CURVED CORRECTION	32-47	
No operation	48-95	
CORNER CORRECTION	96-111	
No operation	112-255	

■ FREEZE

Performance	Parameter	Default value
No operation	0-31	128
OFF	32-95	
No operation	96-159	
ON	160-223	
No operation	224-255	

■ COLOR, TINT

Performance	Parameter	Default value
No operation	0-31	0
Factory default setting	32-63	
-31	64	
...	...	
0	128-129	
...	...	
+31	191	
No operation	192-255	

■ RASTER PATTERN

Performance	Parameter	Default value
No operation	0-15	0
OFF	16-31	
WHITE	32-47	
YELLOW	48-63	
CYAN	64-79	
GREEN	80-95	
MAGENTA	96-111	
RED	112-127	
BLUE	128-143	
BLACK	144-159	
USER LOGO	160-175	
No operation	176-255	

■ [AUDIO VOLUME]

Performance	Parameter	Default value
No operation	0-31	0
Factory default setting	32-63	
0	64-65	
...	...	
63	190-191	
No operation	192-255	

■ ENABLE / DISABLE

Operation for all channels is not accepted when set to “Disable”.

Performance	Parameter	Default value
Disable	0-127	0
Enable	128-255	

Note

- If the projector is operated using the remote control or the control panel, or by the control command while controlling the projector using the Art-Net function, the setting of the DMX controller or computer application may be different from the projector status. To reflect the controls of all channels to the projector, set “ENABLE / DISABLE” of channel 11 to “Disable” and then back to “Enable”.
- To create/register the USER LOGO image, use “Logo Transfer Software” included in the supplied CD-ROM.

Control commands via LAN

When web control administrator rights password is set (Protect mode)

Connecting

- 1) Obtain the IP address and port number (Initial set value = 1024) of the projector and request a connection to the projector.

- You can obtain both the IP address and the port number from the menu screen of the projector.

IP address	Obtain from the [NETWORK] menu → [NETWORK STATUS].
Port number	Obtain from the [NETWORK] menu → [NETWORK CONTROL] → [COMMAND PORT].

- 2) Check the response from the projector.

	Data section	Blank	Mode	Blank	Random number section	Termination symbol
Command example	“NTCONTROL” (ASCII string)	‘ ’ 0x20	‘1’ 0x31	‘ ’ 0x20	“ZZZZZZZZ” (ASCII code hex number)	(CR) 0x0d
Data length	9 bytes	1 byte	1 byte	1 byte	8 bytes	1 byte

- Mode: 1 = Protect mode
- Example: Response during protect mode (random number section is undefined value)
“NTCONTROL 1 23181e1e” (CR)

- 3) Generate a 32-byte hash value from the following data using MD5 algorithm.

- “xxxxxx:yyyy:ZZZZZZZZ”

xxxxxx	Administrator rights user name for the web control (default user name is “admin1”)
yyyyy	Password of above administrator rights user (default password is “panasonic”)
ZZZZZZZZ	8-byte random number obtained in Step 2)

Command transmission method

Transmit using the following command formats.

■ **Transmitted data**

	Header			Data section	Termination symbol
Command example	Hash value "Connecting" (➔ page 160)	'0' 0x30	'0' 0x30	Control command (ASCII string)	(CR) 0x0d
Data length	32 bytes	1 byte	1 byte	Undefined length	1 byte

- Example: Transmission of power supply status acquisition command (hash value is calculated from default user name, password, and acquired random number)
"dbdd2dabd3d4d68c5dd970ec0c29fa6400QPW" (CR)

■ **Received data**

	Header		Data section	Termination symbol
Command example	'0' 0x30	'0' 0x30	Control command (ASCII string)	(CR) 0x0d
Data length	1 byte	1 byte	Undefined length	1 byte

- Example: The projector is powered on
"00001" (CR)

■ **Error response**

	String	Details	Termination symbol
Message	"ERR1"	Undefined control command	(CR) 0x0d
	"ERR2"	Out of parameter range	
	"ERR3"	Busy state or no-acceptable period	
	"ERR4"	Timeout or no-acceptable period	
	"ERR5"	Wrong data length	
	"ERRA"	Password mismatch	
Data length	4 bytes	—	1 byte

When web control administrator rights password is not set (Non-protect mode)

Connecting

- 1) **Obtain the IP address and port number (Initial set value = 1024) of the projector and request a connection to the projector.**
 - You can obtain both the IP address and the port number from the menu screen of the projector.

IP address	Obtain from the [NETWORK] menu → [NETWORK STATUS].
Port number	Obtain from the [NETWORK] menu → [NETWORK CONTROL] → [COMMAND PORT].

- 2) **Check the response from the projector.**

	Data section	Blank	Mode	Termination symbol
Command example	"NTCONTROL" (ASCII string)	' ' 0x20	'0' 0x30	(CR) 0x0d
Data length	9 bytes	1 byte	1 byte	1 byte

- Mode: 0 = Non-protect mode
- Example: Response during non-protect mode
"NTCONTROL 0" (CR)

Command transmission method

Transmit using the following command formats.

■ **Transmitted data**

	Header		Data section	Termination symbol
Command example	'0' 0x30	'0' 0x30	Control command (ASCII string)	(CR) 0x0d
Data length	1 byte	1 byte	Undefined length	1 byte

- Example: Transmission of power supply status acquisition command
"00QPW" (CR)

■ **Received data**

	Header		Data section	Termination symbol
Command example	'0' 0x30	'0' 0x30	Control command (ASCII string)	(CR) 0x0d
Data length	1 byte	1 byte	Undefined length	1 byte

- Example: The power of the projector is in standby status
"00000" (CR)

■ **Error response**

	String	Details	Termination symbol
Message	"ERR1"	Undefined control command	(CR) 0x0d
	"ERR2"	Out of parameter range	
	"ERR3"	Busy state or no-acceptable period	
	"ERR4"	Timeout or no-acceptable period	
	"ERR5"	Wrong data length	
	"ERRA"	Password mismatch	
Data length	4 bytes	—	1 byte

<SERIAL IN> terminal

The <SERIAL IN> terminal of the projector conforms with RS-232C so that the projector can be connected to and controlled from a computer.

Connection

When connecting directly

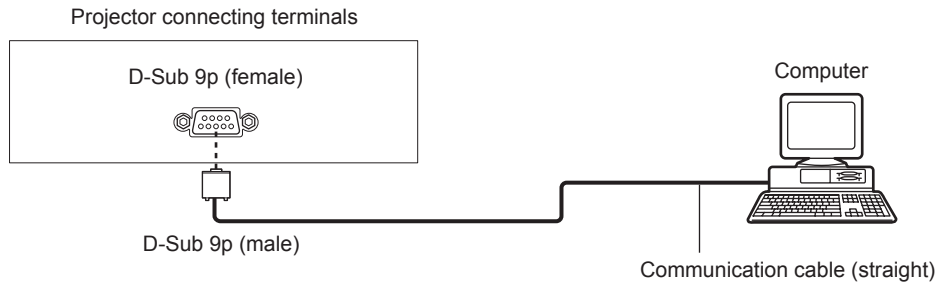

When connecting using DIGITAL LINK compatible device

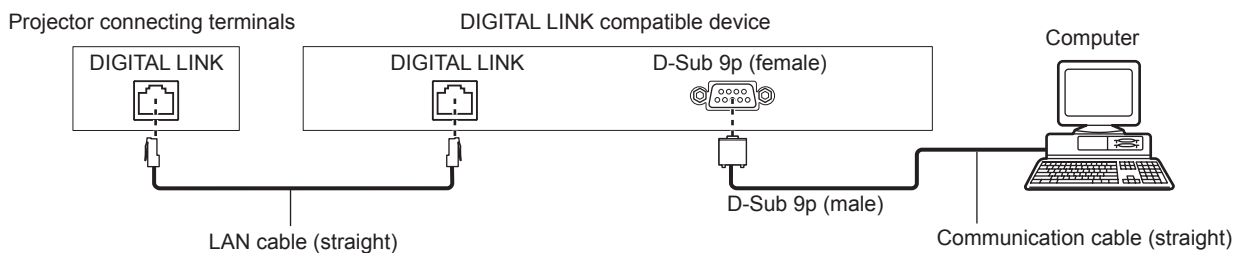

Note

- The destination of [RS-232C] (➔ page 106) must be set according to the connection method.
- When connecting using a DIGITAL LINK compatible device, set the [PROJECTOR SETUP] menu → [ECO MANAGEMENT] → [STANDBY MODE] to [NORMAL] to control the projector in the standby mode.
When [STANDBY MODE] is set to [ECO], the projector cannot be control during standby.

Pin assignments and signal names

D-Sub 9-pin (female) Outside view	Pin No.	Signal name	Details
	(1)	—	NC
	(2)	TXD	Transmitted data
	(3)	RXD	Received data
	(4)	—	NC
	(5)	GND	Earth
	(6)	—	NC
	(7)	CTS	Connected internally
	(8)	RTS	
	(9)	—	NC

Communication conditions (Factory default)

Signal level	RS-232C-compliant
Sync. method	Asynchronous
Baud rate	9 600 bps
Parity	None
Character length	8 bits
Stop bit	1 bit
X parameter	None
S parameter	None

Basic format

Transmission from the computer starts with STX, then the ID, command, parameter, and ETX are sent in this order. Add parameters according to the details of control.

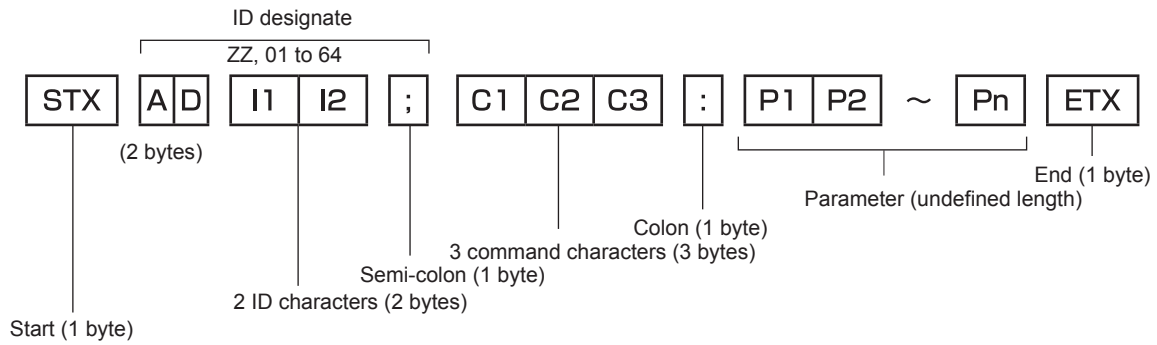

Basic format (has subcommands)

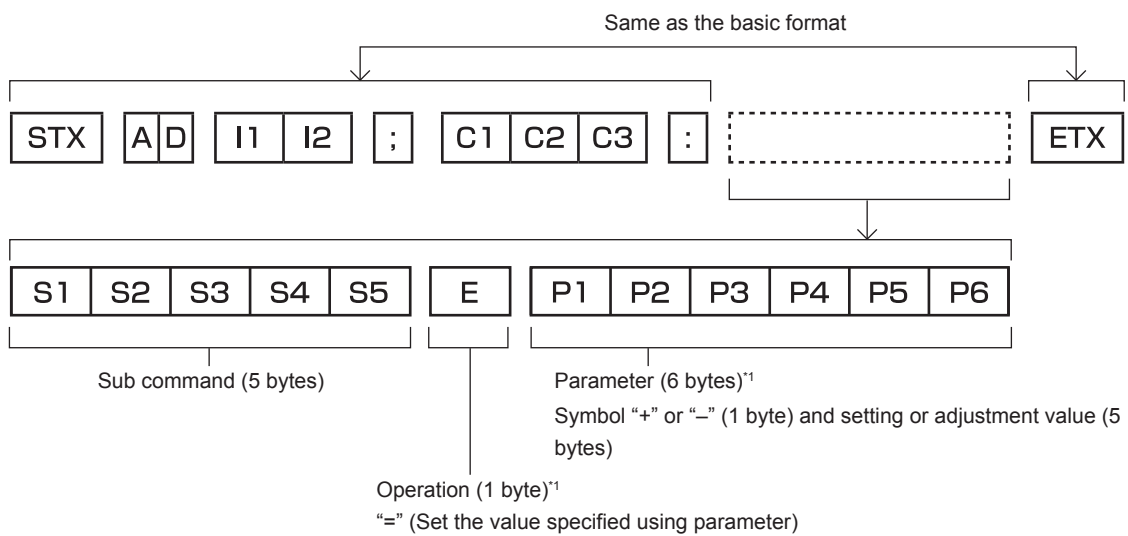

*1 When transmitting a command which does not need a parameter, an operation (E) and parameter are not necessary.

Attention

- If a command is sent after the light source starts lighting, there may be a delay in response or the command may not be executed. Try sending or receiving any command after 60 seconds.
- When transmitting multiple commands, be sure to wait until 0.5 seconds has elapsed after receiving the response from the projector before sending the next command. When transmitting a command which does not need a parameter, a colon (:) is not necessary.

Note

- If a command cannot be executed, the "ER401" response is sent from the projector to the computer.
- If an invalid parameter is sent, the "ER402" response is sent from the projector to the computer.
- ID transmission in RS-232C supports ZZ (ALL) and 01 to 64.
- If a command is sent with an ID designated, a response will be sent to the computer only in the following cases.
 - It matches the projector ID
 - ID is designated as ALL and [RESPONSE(ID ALL)] is set to [ON]
- STX and ETX are character codes. STX shown in hexadecimal is 02, and ETX shown in hexadecimal is 03.

Cable specification

When connected to a computer

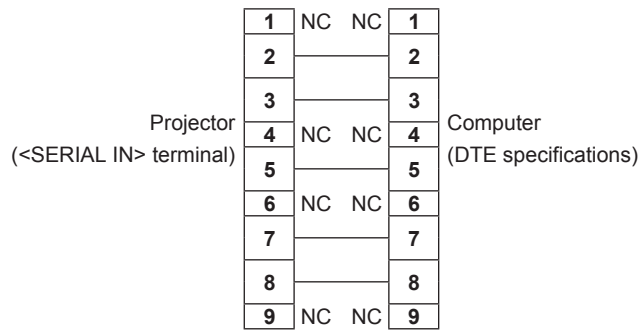

Control command

The following table lists the commands that can be used to control the projector using a computer.

■ Projector control command

Command	Details	Parameter/response string	Remark (parameter)
PON	Power on	—	To check if the power is on, use the “Power query” command.
POF	Power standby		
QPW	Power query	000 001	STANDBY Power on
IIS	Switching the input signal	VID RG1 RG2 DVI HD1 HD2 DL1	VIDEO COMPUTER1 COMPUTER2 DVI-D HDMI1 HDMI2 DIGITAL LINK
OSH	Shutter control	0	OPEN
QSH	Shutter status query	1	CLOSE
VSE	Aspect ratio switch	0 1 2 5	DEFAULT/VID AUTO/AUTO 4:3 16:9 THROUGH
QSE	Aspect ratio settings query	6 9 10	HV FIT H FIT V FIT
OPP	P IN P execution	0 1	OFF USER1
QPP	P IN P setting query	2 3	USER2 USER3
OCS	Sub memory switch	01 - 96	Sub memory number
QSB	Sub memory status query		

■ Projector control command (with sub command)

Command	Sub command	Details	Remark
VXX	RYC11	COMPUTER1 input setting	+00000 = RGB/YP _B P _R , +00001 = Y/C

Two-window display combination list

✓: P IN P (picture in picture) combination is possible

—: P IN P (picture in picture) combination is not possible

Main window		Sub window						
		COMPUTER1	COMPUTER2	DVI-D	VIDEO	HDMI1	HDMI2	DIGITAL LINK
COMPUTER1 input	Still image signal							
	Moving image signal	—	✓	—	✓*1	—	✓	✓
	Y/C signal							
COMPUTER2 input	Still image signal	✓	—	✓	✓	✓	—	—
	Moving image signal							
DVI-D input	Still image signal	—	✓	—	✓	—	✓	✓
	Moving image signal							
VIDEO input	Video signal	✓*1	✓	✓	—	✓	✓	✓
HDMI1 input	Still image signal	—	✓	—	✓	—	✓	✓
	Moving image signal							
HDMI2 input	Still image signal	✓	—	✓	✓	✓	—	—
	Moving image signal							
DIGITAL LINK input	Still image signal	✓	—	✓	✓	✓	—	—
	Moving image signal							

*1 Only when the [DISPLAY OPTION] menu → [COMPUTER IN/OUT] (COMPUTER1 input) → [INPUT SETTING] is set to [RGB/YP_BP_R]

Control device password

To initialize your password, consult your distributor.

List of compatible signals

The following table specifies the video signals compatible with the projector.

- Symbols that indicate formats are as follows.
 - V: VIDEO, Y/C
 - R: RGB
 - Y: YC_BC_R/YP_BP_R
 - D: DVI-D
 - H: HDMI
- Input corresponding to each item in the plug and play column is as follows.
 - COMPUTER: COMPUTER1/COMPUTER2 input
 - DVI-D: DVI-D input
 - HDMI/DL: HDMI1/HDMI2 input, DIGITAL LINK input

Compatible signal	Resolution (Dots)	Scanning freq.		Dot clock freq. (MHz)	Format	Plug and play ¹				
		Horizontal (kHz)	Vertical (Hz)			COMPUTER	DVI-D			HDMI/DL
							EDID1	EDID2	EDID3	
NTSC/NTSC4.43/ PAL-M/PAL60	720 x 480i	15.7	59.9	—	V	—	—	—	—	—
PAL/PAL-N/SECAM	720 x 576i	15.6	50.0	—	V	—	—	—	—	—
525i (480i)	712 x 483i	15.7	59.9	13.5	R/Y	—	—	—	—	—
625i (576i)	702 x 575i	15.6	50.0	13.5	R/Y	—	—	—	—	—
525i (480i)	720 (1 440) x 480i ²	15.7	59.9	27.0	D/H	—	—	—	—	—
625i (576i)	720 (1 440) x 576i ²	15.6	50.0	27.0	D/H	—	—	—	—	—
525p (480p)	720 x 480	31.5	59.9	27.0	R/Y/D/H	—	✓	—	✓	✓
625p (576p)	720 x 576	31.3	50.0	27.0	R/Y/D/H	—	✓	—	✓	✓
750 (720)/60p	1 280 x 720	45.0	60.0	74.3	R/Y/D/H	—	✓	—	✓	✓
750 (720)/50p	1 280 x 720	37.5	50.0	74.3	R/Y/D/H	—	✓	—	✓	✓
1125 (1080)/60i ³	1 920 x 1 080i	33.8	60.0	74.3	R/Y/D/H	—	✓	—	✓	✓
1125 (1080)/50i	1 920 x 1 080i	28.1	50.0	74.3	R/Y/D/H	—	✓	—	✓	✓
1125 (1080)/24p	1 920 x 1 080	27.0	24.0	74.3	R/Y/D/H	—	✓	—	✓	✓
1125 (1080)/24sF	1 920 x 1 080i	27.0	48.0	74.3	R/Y/D/H	—	—	—	—	—
1125 (1080)/25p	1 920 x 1 080	28.1	25.0	74.3	R/Y/D/H	—	✓	—	✓	—
1125 (1080)/30p	1 920 x 1 080	33.8	30.0	74.3	R/Y/D/H	—	—	—	—	—
1125 (1080)/60p	1 920 x 1 080	67.5	60.0	148.5	R/Y/D/H	—	✓	—	✓	✓
1125 (1080)/50p	1 920 x 1 080	56.3	50.0	148.5	R/Y/D/H	—	✓	—	✓	✓
640 x 400/70	640 x 400	31.5	70.1	25.2	R/D/H	—	—	—	—	—
640 x 400/85	640 x 400	37.9	85.1	31.5	R/D/H	—	—	—	—	—
640 x 480/60	640 x 480	31.5	59.9	25.2	R/D/H	✓	✓	✓	✓	✓
640 x 480/67	640 x 480	35.0	66.7	30.2	R/D/H	—	—	—	—	—
640 x 480/73	640 x 480	37.9	72.8	31.5	R/D/H	✓	—	✓	✓	✓
640 x 480/75	640 x 480	37.5	75.0	31.5	R/D/H	✓	—	✓	✓	✓
640 x 480/85	640 x 480	43.3	85.0	36.0	R/D/H	—	—	—	—	—
800 x 600/56	800 x 600	35.2	56.3	36.0	R/D/H	✓	—	✓	✓	✓
800 x 600/60	800 x 600	37.9	60.3	40.0	R/D/H	✓	—	✓	✓	✓
800 x 600/72	800 x 600	48.1	72.2	50.0	R/D/H	✓	—	✓	✓	✓
800 x 600/75	800 x 600	46.9	75.0	49.5	R/D/H	✓	—	✓	✓	✓
800 x 600/85	800 x 600	53.7	85.1	56.3	R/D/H	—	—	—	—	—
832 x 624/75	832 x 624	49.7	74.6	57.3	R/D/H	✓	—	✓	✓	✓
1024 x 768/50	1 024 x 768	39.6	50.0	51.9	R/D/H	—	—	—	—	—
1024 x 768/60	1 024 x 768	48.4	60.0	65.0	R/D/H	✓	—	✓	✓	✓
1024 x 768/70	1 024 x 768	56.5	70.1	75.0	R/D/H	✓	—	✓	✓	✓
1024 x 768/75	1 024 x 768	60.0	75.0	78.8	R/D/H	✓	—	✓	✓	✓
1024 x 768/82	1 024 x 768	65.5	81.6	86.0	R/D/H	—	—	—	—	—
1024 x 768/85	1 024 x 768	68.7	85.0	94.5	R/D/H	—	—	—	—	—
1024 x 768/100	1 024 x 768	81.4	100.0	113.3	R/D/H	—	—	—	—	—
1024 x 768/120	1 024 x 768	98.7	120.0	139.1	R/D/H	✓	—	✓	✓	✓

Chapter 7 Appendix — Technical information

Compatible signal	Resolution (Dots)	Scanning freq.		Dot clock freq. (MHz)	Format	Plug and play ^{*1}				
		Horizontal (kHz)	Vertical (Hz)			COMPUTER	DVI-D			HDMI/DL
							EDID1	EDID2	EDID3	
1152 x 864/60	1 152 x 864	53.7	60.0	81.6	R/D/H	—	—	—	—	—
1152 x 864/70	1 152 x 864	64.0	70.0	94.2	R/D/H	—	—	—	—	—
1152 x 864/75	1 152 x 864	67.5	75.0	108.0	R/D/H	—	—	—	—	—
1152 x 864/85	1 152 x 864	77.1	85.0	119.7	R/D/H	—	—	—	—	—
1152 x 870/75	1 152 x 870	68.7	75.1	100.0	R/D/H	✓	—	✓	✓	✓
1280 x 720/50	1 280 x 720	37.1	49.8	60.5	R/D/H	—	—	—	—	—
1280 x 720/60	1 280 x 720	44.8	59.9	74.5	R/D/H	—	—	—	—	—
1280 x 720/100	1 280 x 720	76.3	100.0	131.8	R/D/H	—	—	—	—	—
1280 x 720/120	1 280 x 720	92.6	120.0	161.6	R/D/H	—	—	—	—	—
1280 x 768/50	1 280 x 768	39.6	49.9	65.3	R/D/H	—	—	—	—	—
1280 x 768/60	1 280 x 768	47.8	59.9	79.5	R/D/H	—	—	—	—	—
	1 280 x 768 ^{*4}	47.4	60.0	68.3	R/D/H	—	—	—	—	—
1280 x 768/75	1 280 x 768	60.3	74.9	102.3	R/D/H	—	—	—	—	—
1280 x 768/85	1 280 x 768	68.6	84.8	117.5	R/D/H	—	—	—	—	—
1280 x 800/50	1 280 x 800	41.3	50.0	68.0	R/D/H	—	—	—	—	—
1280 x 800/60	1 280 x 800	49.7	59.8	83.5	R/D/H	—	—	—	—	—
	1 280 x 800 ^{*4}	49.3	59.9	71.0	R/D/H	—	—	—	—	—
1280 x 800/75	1 280 x 800	62.8	74.9	106.5	R/D/H	—	—	—	—	—
1280 x 800/85	1 280 x 800	71.6	84.9	122.5	R/D/H	—	—	—	—	—
1280 x 960/60	1 280 x 960	60.0	60.0	108.0	R/D/H	—	—	—	—	—
1280 x 1024/50	1 280 x 1 024	52.4	50.0	88.0	R/D/H	—	—	—	—	—
1280 x 1024/60	1 280 x 1 024	64.0	60.0	108.0	R/D/H	—	—	—	—	—
1280 x 1024/66	1 280 x 1 024	72.3	66.3	125.0	R/D/H	—	—	—	—	—
1280 x 1024/72	1 280 x 1 024	78.2	72.0	135.1	R/D/H	—	—	—	—	—
1280 x 1024/75	1 280 x 1 024	80.0	75.0	135.0	R/D/H	✓	—	✓	✓	✓
1280 x 1024/85	1 280 x 1 024	91.1	85.0	157.5	R/D/H	—	—	—	—	—
1366 x 768/50	1 366 x 768	39.6	49.9	69.0	R/D/H	—	—	—	—	—
1366 x 768/60	1 366 x 768	47.7	59.8	85.5	R/D/H	—	—	—	—	—
1400 x 1050/50	1 400 x 1 050	54.1	50.0	99.9	R/D/H	—	—	—	—	—
1400 x 1050/60	1 400 x 1 050	64.0	60.0	108.0	R/D/H	—	—	—	—	—
	1 400 x 1 050	65.3	60.0	121.8	R/D/H	—	—	—	—	—
	1 400 x 1 050	65.2	60.0	122.6	R/D/H	✓	—	✓	✓	✓
1400 x 1050/72	1 400 x 1 050	78.8	72.0	149.3	R/D/H	—	—	—	—	—
1400 x 1050/75	1 400 x 1 050	82.2	75.0	155.9	R/D/H	—	—	—	—	—
1440 x 900/50	1 440 x 900	46.3	49.9	86.8	R/D/H	—	—	—	—	—
1440 x 900/60	1 440 x 900	55.9	59.9	106.5	R/D/H	—	—	—	—	—
1600 x 900/50	1 600 x 900	46.4	49.9	96.5	R/D/H	—	—	—	—	—
1600 x 900/60	1 600 x 900	55.9	60.0	119.0	R/D/H	✓	—	✓	✓	✓
1600 x 1200/50	1 600 x 1 200	61.8	49.9	131.5	R/D/H	—	—	—	—	—
1600 x 1200/60	1 600 x 1 200	75.0	60.0	162.0	R/D/H	✓	—	✓	✓	✓
1680 x 1050/50	1 680 x 1 050	54.1	50.0	119.5	R/D/H	—	—	—	—	—
1680 x 1050/60	1 680 x 1 050	65.3	60.0	146.3	R/D/H	—	—	—	—	—
1920 x 1080/50	1 920 x 1 080	55.6	49.9	141.5	R/D/H	—	—	—	—	—
1920 x 1080/60	1 920 x 1 080 ^{*4}	66.6	59.9	138.5	R/D/H	—	—	—	—	—
	1 920 x 1 080 ^{*5}	67.2	60.0	173.0	R	—	—	—	—	—
1920 x 1200/50	1 920 x 1 200	61.8	49.9	158.3	R/D/H	—	—	—	—	—
1920 x 1200/60	1 920 x 1 200 ^{*5}	74.6	59.9	193.3	R	—	—	—	—	—
1920 x 1200/60RB	1 920 x 1 200 ^{*4}	74.0	60.0	154.0	R/D/H	✓	—	✓	✓	✓

*1 Signal with ✓ in the plug and play column is a signal described in the EDID (extended display identification data) of the projector. The signal that does not have ✓ in the plug and play column can also be input if it is described in the format column. The resolution may not be selected in the computer even if the projector is compatible for the signal that does not have ✓ in the plug and play column.

*2 Pixel-Repetition signal (dot clock frequency 27.0 MHz) only

*3 When a 1125 (1035)/60i signal is input, the image is displayed as a 1125 (1080)/60i signal.

*4 VESA CVT-RB (Reduced Blanking)-compliant

*5 Samples the pixels in the image processing circuit and projects the image.

Note

- A signal with a different resolution is converted to the number of display dots. The number of display dots is as follows.

– 1 920 x 1 200

- The “i” at the end of the resolution indicates an interlaced signal.
- When interlaced signals are connected, flickering may occur on the projected image.
- DIGITAL LINK input compatible signal is the same as HDMI input compatible signal.

Specifications

The specifications of the projector are as follows.

Power supply		PT-RZ570B, PT-RZ570W, PT-RZ570BD, PT-RZ570WD, PT-RZ570BA, PT-RZ570WA	100 V - 240 V ~ (100 V - 240 V alternating current), 50 Hz/60 Hz
		PT-RZ570BT, PT-RZ570WT	110 V ~ (110 V alternating current), 60 Hz
Power consumption		PT-RZ570B, PT-RZ570W, PT-RZ570BD, PT-RZ570WD, PT-RZ570BA, PT-RZ570WA	500 W (5.9 A - 2.3 A)
		PT-RZ570BT, PT-RZ570WT	500 W (5.2 A)
Power consumption (during standby)		When [STANDBY MODE] is set to [ECO]: approx. 0.5 W	
		When [STANDBY MODE] is set to [NORMAL]: approx. 10 W	
		When [IN STANDBY MODE] in [AUDIO SETTING] is set to [ON], and the [QUICK STARTUP] function is disabled: approx. 22 W	
		When the [QUICK STARTUP] function is enabled: approx. 50 W	
DLP chip	Size	17 mm (0.67") (aspect ratio 16:10)	
	Display system	DLP chip x 1, DLP projection system	
	Number of pixels	2 304 000 pixels (1 920 x 1 200 dots)	
Lens	Zoom	1.5 to 2.9:1	
	Focus	F = 2.0 to 3.4 f = 21.5 mm to 43.0 mm	
Light source		Laser	
Light output*1		5 200 lm (ANSI)	
Contrast ratio*1		20 000:1 (when [DYNAMIC CONTRAST] is set to [ON])	
Color system		7 standards (NTSC/NTSC4.43/PAL/PAL-N/PAL-M/SECAM/PAL60)	
Projected image size		1.02 m (40") to 7.62 m (300")	
Image aspect ratio		16:10	
Projection method		[FRONT/REAR]/[FLOOR/CEILING]	
Power cord length		3.0 m (118-1/8")	
Outer case		Molded plastic	
Outer color		Black model	Black
		White model	White
Dimensions	Width	498 mm (19-5/8")	
	Height	168 mm (6-5/8") (with the feet at shortest position)	
	Depth	492 mm (19-3/8") (including the lens)	
Weight		Approx. 16.3 kg (35.9 lbs.) ²	
Noise level*1		33 dB	
Operating environment	Operating environment temperature	0 °C (32 °F) to 45 °C (113 °F) ³	
	Operating environment humidity	10 % to 80 % (no condensation)	
Remote control	Power supply	DC 3 V (AAA/R03/LR03 battery x 2)	
	Operating range	Within approx. 30 m (98'5") (when operated directly in front of signal receiver)	
	Weight	102 g (3.6 ozs.) (including batteries)	
	Dimensions	Width: 48 mm (1-29/32"), Height: 145 mm (5-23/32"), Depth: 27 mm (1-1/16")	

*1 Measurement, measuring conditions and method of notation all comply with ISO21118 international standards.

*2 Average value. Weight varies for each product.

*3 The operating environment temperature should be between 0 °C (32 °F) and 40 °C (104 °F) if the projector is used at an altitude between 1 400 m (4 593') and 4 200 m (13 780') above sea level. When the [PROJECTOR SETUP] menu → [ECO MANAGEMENT] → [OPERATING MODE] is set to [ECO] or [SILENT], the projector cannot be used at an altitude of 2 700 m (8 858') or higher above sea level. When using the projector at an altitude lower than 2 700 m (8 858') above sea level, and the operating environment temperature becomes 35 °C (95 °F) or higher, the light output may be reduced to protect the projector. When using the projector at an altitude between 2 700 m (8 858') and 4 200 m (13 780'), and the operating environment temperature becomes 25 °C (77 °F) or higher, the light output may be reduced to protect the projector.

Note

- The model numbers of accessories and optional accessories are subject to change without prior notice.

■ Connecting terminal

<COMPUTER 1 IN> terminal	<p>1 set, high-density D-Sub 15 p (female)</p> <p>RGB signal 0.7 V [p-p] 75 Ω (SYNC ON GREEN: 1.0 V [p-p] 75 Ω) SYNC/HD TTL high impedance, automatic positive/negative polarity compatible VD TTL high impedance, automatic positive/negative polarity compatible</p> <p>Y_BP_R signal Y: 1.0 V [p-p] including synchronization signal, P_BP_R: 0.7 V [p-p] 75 Ω Y/C signal Y: 1.0 V [p-p], C: 0.286 V [p-p] 75 Ω</p>
<COMPUTER 2 IN/1 OUT> terminal	<p>1 set, high-density D-Sub 15 p (female)</p> <p>RGB signal 0.7 V [p-p] 75 Ω (SYNC ON GREEN: 1.0 V [p-p] 75 Ω) SYNC/HD TTL high impedance, automatic positive/negative polarity compatible VD TTL high impedance, automatic positive/negative polarity compatible</p> <p>Y_BP_R signal Y: 1.0 V [p-p] including synchronization signal, P_BP_R: 0.7 V [p-p] 75 Ω</p>
<DVI-D IN> terminal	1 set, DVI-D 24 p, single link, DVI 1.0 compliant, HDCP compatible
<HDMI 1 IN> terminal	Total 2 sets, HDMI 19 p, HDCP compatible, Deep Color compatible
<HDMI 2 IN> terminal	Audio signal Linear PCM (sampling frequency: 48 kHz/44.1 kHz/32 kHz)
<VIDEO IN> terminal	1 set, pin jack, 1.0 V [p-p] 75 Ω
<AUDIO IN 1> terminal	1 set, pin jack x 2 (L-R), 0.5 V [rms], input impedance 22 kΩ or more
<AUDIO IN 2> terminal	Total 2 sets, M3 stereo mini jack, 0.5 V [rms], input impedance 22 kΩ or more
<AUDIO IN 3> terminal	Total 2 sets, M3 stereo mini jack, 0.5 V [rms], input impedance 22 kΩ or more
<VARIABLE AUDIO OUT> terminal	1 set, M3 stereo mini jack (monitor output, stereo compatible), 0 V [rms] to 1.80 V [rms] (variable), output impedance 2.2 kΩ or less
<SERIAL IN> terminal	D-Sub 9 p, 1 set, RS-232C compliant, for computer control
<DIGITAL LINK/LAN> terminal	1 set, RJ-45, for network and DIGITAL LINK connections (HDBaseT™ compliant), PJLink compatible, 100Base-TX, Art-Net compatible, HDCP 2.2 compatible, Deep Color compatible
<LAN> terminal	1 set, RJ-45, for network connection, PJLink compatible, 10Base-T/100Base-TX, Art-Net compatible
<DC OUT> terminal	USB connector (type A) x 1, for power supply only (DC 5 V, maximum 900 mA)

■ Compatible signal

For details of the types of video signals that can be used with the projector, refer to “List of compatible signals” (➔ page 167).

Video input, Y/C input
Horizontal: 15.73 kHz, Vertical: 59.94 Hz; Horizontal: 15.63 kHz, Vertical: 50 Hz
RGB input
<ul style="list-style-type: none"> • Resolution: 640 x 400 to 1 920 x 1 200 • Dot clock frequency: 162 MHz or less • PIAS (Panasonic Intelligent Auto Scanning) system
Y_CC_R/Y_PP_R input
<ul style="list-style-type: none"> • Resolution: 480i/576i to 1 920 x 1 080 • Dot clock frequency: 148.5 MHz or lower • The HD/SYNC and VD terminals do not support 3 value SYNC.
DVI-D input
<ul style="list-style-type: none"> • Moving image signal resolution: 480i^{*1}/576i^{*1} to 1 920 x 1 080 • Still image signal resolution: 640 x 400 to 1 920 x 1 200 (non-interlace) • Dot clock frequency: 25 MHz to 162 MHz
HDMI input
<ul style="list-style-type: none"> • Moving image signal resolution: 480i^{*1}/576i^{*1} to 1 920 x 1 080 • Still image signal resolution: 640 x 400 to 1 920 x 1 200 (non-interlace) • Dot clock frequency: 25 MHz to 162 MHz

*1 Pixel-Repetition signal (dot clock frequency 27.0 MHz) only

Note

- DIGITAL LINK input compatible signal is the same as HDMI input compatible signal.

Dimensions

Unit: mm

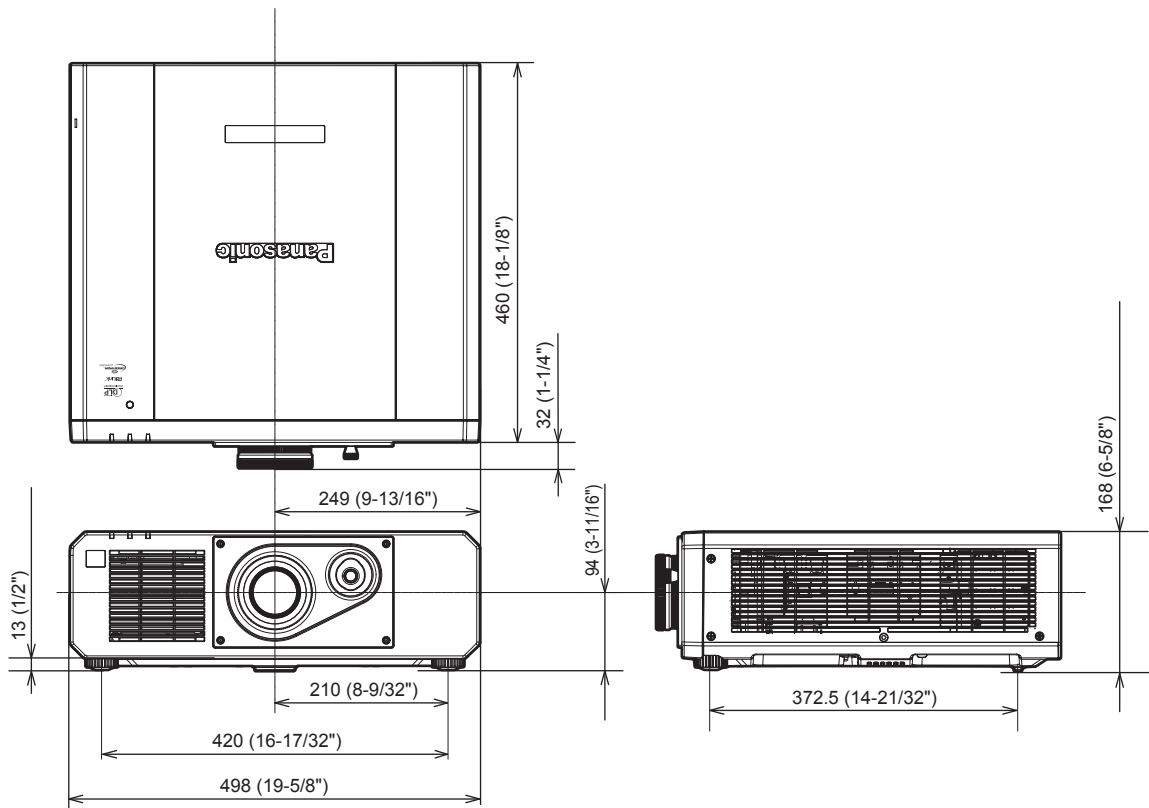

* Actual dimensions may differ depending on the product.

Precautions for attaching the Ceiling Mount Bracket

- When installing the projector to a ceiling, be sure to use the specified optional Ceiling Mount Bracket (Model No.: ET-PKD120H (for High Ceilings), ET-PKD120S (for Low Ceilings), ET-PKD130B (Projector Mount Bracket)). The Ceiling Mount Bracket (Model No.: ET-PKD120H (for High Ceilings), ET-PKD120S (for Low Ceilings)) is used in combination with the Ceiling Mount Bracket (Model No.: ET-PKD130B (Projector Mount Bracket)).
- Attach the drop-prevention set that comes with the Ceiling Mount Bracket to the projector. If you need the drop-prevention set (Service Model No.: TTRA0214) is necessary, consult your dealer.
- Ask a qualified technician to do the installation work such as mounting the projector on the ceiling.
- Panasonic takes no responsibility for any damage to the projector resulting from use of the Ceiling Mount Bracket not manufactured by Panasonic or the inappropriate choice of location for installing the Ceiling Mount Bracket, even if the warranty period of the projector has not expired.
- Unused products must be removed promptly by a qualified technician.
- Use a torque screwdriver or Allen torque wrench to tighten bolts to their specified tightening torques. Do not use electric screwdrivers or impact screwdrivers.
- Read the Installation Instructions of the Ceiling Mount Bracket for details.
- The model numbers of accessories and optional accessories are subject to change without prior notice.

Bottom view

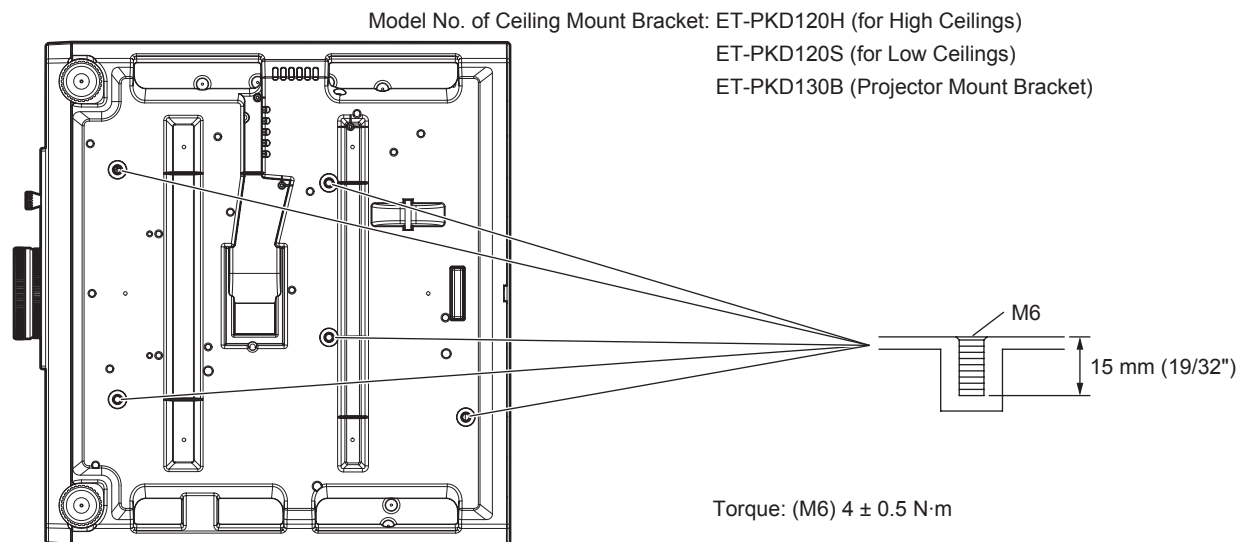

Index

- A**
- Accessories 22
 - <AC IN> terminal 27, 40
 - Adjusting adjustable feet 33
 - [ADVANCED MENU] 59, 73
 - Art-Net 20, 157
 - [Art-Net CHANNEL SETTING] 125
 - [Art-Net SETUP] 124
 - [Art-Net STATUS] 125
 - [ASPECT] 68
 - <ASPECT> button
 - Remote control 24, 53
 - Aspect function 53
 - [AUDIO SETTING] 107
 - Automatic setup function 52
 - [AUTO SETUP] 81
 - <AUTO SETUP> button
 - Remote control 24, 52
 - [AUTO SIGNAL] 81
- B**
- [BACK COLOR] 90
 - [BLANKING] 73
 - [BRIGHTNESS] 62
 - [BRIGHTNESS CONTROL] 99
- C**
- Cautions on use 20
 - Cautions when installing 17
 - Cautions when transporting 17
 - Ceiling Mount Bracket 174
 - [CLAMP POSITION] 74
 - [CLOCK PHASE] 70
 - [CLOSED CAPTION SETTING] 89
 - [COLOR] 63
 - [COLOR CORRECTION] 80
 - [COLOR MATCHING] 79
 - [COLOR TEMPERATURE] 63
 - <COMPUTER 1/2> button
 - Remote control 24, 47
 - [COMPUTER IN/OUT] 82
 - Connecting the power cord 40
 - Connection 34
 - [CONTRAST] 62
 - [CONTROL DEVICE PASSWORD CHANGE] 120
 - [CONTROL DEVICE SETUP] 119
 - [Crestron Connected(TM)] 144
 - [CUT OFF] 94
- D**
- [DATE AND TIME] 109
 - [DAYLIGHT VIEW] 65
 - <DEFAULT> button
 - Remote control 24, 58
 - Deleting the registered signal 115
 - [DIGITAL CINEMA REALITY] 73
 - DIGITAL LINK 20
 - <DIGITAL LINK> button
 - Remote control 24, 47
 - [DIGITAL LINK IN] 86
 - [DIGITAL LINK MENU] 124
 - [DIGITAL LINK MODE] 122
 - [DIGITAL LINK STATUS] 122
 - Dimensions 173
 - Display language 60, 78
 - [DISPLAY OPTION] 60, 79
 - [DISPLAY SETTING] 118
 - Disposal 20
 - <DVI-D> button
 - Remote control 24, 47
 - [DVI-D IN] 84
 - [DYNAMIC CONTRAST] 66
- E**
- Early Warning Software 20
 - <ECO> button
 - Remote control 24, 54
 - [ECO MANAGEMENT] 96
 - [EDGE BLENDING] 74
 - <ENTER> button
 - Projector body 27
 - Remote control 24, 57
 - Expanding signal lock-in range 116
- F**
- [FRAME RESPONSE] 76
 - [FREEZE] 93
 - <FREEZE> button
 - Remote control 24, 51
- G**
- [GAMMA] 65
- H**
- <HDMI 1> button
 - Remote control 24, 47
 - <HDMI 2> button
 - Remote control 24, 47
 - [HDMI IN] 85
- I**
- <ID ALL> button
 - Remote control 24, 54
 - <ID SET> button
 - Remote control 24, 54
 - [INITIALIZE] 111
 - Initial setting 42
 - [INITIAL STARTUP] 105
 - [INPUT RESOLUTION] 74
 - <INPUT SELECT> button
 - Projector body 27, 48
 - Installation mode 30
- L**
- Light source indicator 148
 - List of compatible signals 167
 - [LOAD ALL USER DATA] 110
- M**
- Main menu 58
 - Main power switch 27, 41
 - Maintenance 150
 - <MENU> button
 - Projector body 27, 57
 - Remote control 24, 57
 - Menu item 59
 - <MUTE> button
 - Remote control 24, 50
- N**
- Navigating through the menu 57
 - [NETWORK] 61, 122
 - Network connection 127
 - [NETWORK CONTROL] 123
 - [NETWORK SETUP] 123
 - [NETWORK STATUS] 124
 - [NOISE REDUCTION] 66
- O**
- <ON SCREEN> button
 - Remote control 24, 51
 - [ON-SCREEN DISPLAY] 87
 - On-screen menu 57
 - Optional accessories 23
- P**
- [PICTURE] 59, 62
 - [PICTURE MODE] 62
 - [P IN P] 61, 112
 - <P IN P> button
 - Remote control 24, 53
 - P IN P function 112
 - [POSITION] 59, 68
 - Power button
 - Projector body 27
 - Remote control 24
 - Power cord 40
 - Power indicator 40
 - Precautions for attaching the Ceiling Mount Bracket 174
 - Precautions for use 17
 - Projecting 47
 - [PROJECTION METHOD] 95
 - Projector body 26
 - [PROJECTOR ID] 95
 - [PROJECTOR SETUP] 60, 95
 - Protecting the registered signal 116
- R**
- [RASTER POSITION] 77
 - Read this first! 5
 - Registering new signals 115
 - Remote control 24
 - Freeze function 51
 - Function button 53
 - <FUNCTION> button
 - Remote control 24, 53
 - [FUNCTION BUTTON] 106
- Remote control operations** 50
- Renaming the registered signal 115
 - Resetting to the factory default 58
 - <RETURN> button
 - Projector body 27
 - Remote control 24
 - [RS-232C] 106, 163
- S**
- [SAVE ALL USER DATA] 110
 - [SCHEDULE] 103
 - <SCREEN ADJ> button
 - Remote control 24, 52
 - [SCREEN ADJUSTMENT] 70
 - [SCREEN SETTING] 80
 - Security 19
 - [SECURITY] 61, 118
 - [SECURITY PASSWORD] 118
 - [SECURITY PASSWORD CHANGE] 118
 - Selecting the input signal 47
 - Self-test indication 153
 - <SERIAL IN> terminal 163
 - [SERVICE PASSWORD] 111
 - Setting ID number of the remote control 54
 - Setting up 30
 - [SHARPNESS] 65
 - [SHIFT] 68
 - <SHUTTER> button
 - Remote control 24, 50
 - [SHUTTER SETTING] 92
 - [SIGNAL LIST] 61, 115
 - Specifications 170
 - sRGB-compliant video 67
 - [STARTUP INPUT SELECT] 105
 - [STARTUP LOGO] 90
 - [STATUS] 108
 - <STATUS> button
 - Remote control 24, 54
 - Sub memory 117
 - Switching off the projector 46
 - Switching on the projector 41
 - [SYSTEM SELECTOR] 66
- T**
- Temperature indicator 148
 - [TEST PATTERN] 61, 114
 - <TEST PATTERN> button
 - Remote control 24, 53
 - [TEXT CHANGE] 119
 - [TINT] 63
 - Troubleshooting 151
 - Two-window 166
- U**
- [UNIFORMITY] 91
- V**
- <VIDEO> button
 - Remote control 24, 47
 - Volume adjustment 51
 - <VOL->/<VOL+> button
 - Remote control 24, 51
- W**
- [WAVEFORM MONITOR] 93
 - Web control 130
 - [WHITE GAIN] 64
- Z**
- [ZOOM] 69

Information for Users on Collection and Disposal of Old Equipment and used Batteries



These symbols on the products, packaging, and/or accompanying documents mean that used electrical and electronic products and batteries should not be mixed with general household waste. For proper treatment, recovery and recycling of old products and used batteries, please take them to applicable collection points, in accordance with your national legislation and the Directives 2002/96/EC and 2006/66/EC.

By disposing of these products and batteries correctly, you will help to save valuable resources and prevent any potential negative effects on human health and the environment which could otherwise arise from inappropriate waste handling.



For more information about collection and recycling of old products and batteries, please contact your local municipality, your waste disposal service or the point of sale where you purchased the items.

Penalties may be applicable for incorrect disposal of this waste, in accordance with national legislation.



For business users in the European Union

If you wish to discard electrical and electronic equipment, please contact your dealer or supplier for further information.

Cd

Information on Disposal in other Countries outside the European Union

These symbols are only valid in the European Union. If you wish to discard these items, please contact your local authorities or dealer and ask for the correct method of disposal.

Note for the battery symbol (bottom two symbol examples):

This symbol might be used in combination with a chemical symbol. In this case it complies with the requirement set by the Directive for the chemical involved.

Product Information (for Turkey only)



AEEE Yönetmeliğine Uygundur.

Eski Ekipman ve Bataryaların İşlenmesi.

Sadece geri dönüşüm sistemleri olan Avrupa Birliği ve ülkeleri için geçerlidir.

Ürünler, ambalaj ve/veya ekli belgeler üzerindeki bu semboller kullanılmış elektrik ve elektronik ürünlerin ve pillerin genel ev atığı ile karıştırılmaması gerektiğini ifade eder.

Eski ürünlerin ve pillerin toplanması ve geri kazanılması için bu atıkları lütfen yasayla belirlenmiş olan uygun toplama merkezlerine teslim ediniz.

Bu atıkların doğru işlenmesiyle, değerli kaynakların korunmasına ve insan sağlığı ve çevreye olası negatif etkilerinin engellenmesine yardımcı olabilirsiniz.

Atıkların toplanması ve geri dönüşümü için detaylı bilgi için lütfen bağlı olduğunuz yerel yönetimlerle iletişime geçiniz.

Atıkların atılmasıyla ilgili yanlış uygulamalar yasayla belirlenmiş olan cezalara sebebiyet verebilir.

Panasonic Corporation

Web Site : <http://panasonic.net/avc/projector/>

© Panasonic Corporation 2016

Panasonic System Communications Company of North America

5th Floor, Two Riverfront Plaza, Newark, NJ 07102-5490

TEL: (877) 803 - 8492

Panasonic Canada Inc.

5770 Ambler Drive, Mississauga, Ontario L4W 2T3

TEL: (905) 624 - 5010