

+



+

REMEMBRANCE

DMX-512 AND ANALOG CONTROL STATIONS

USER GUIDE

Copyright® 2004
Leviton Manufacturing Co., Inc.

+

Table of Contents

System Overview	5
Remember When	5
Welcome Back to Simplicity.	5
What experience is Prerequisite?	5
What is needed?	5
What is not needed?	6
Control Station Operation	7
Play Mode	7
DMX Snapshot Record Mode	7
Record Example:	8
DMX Channel Mode	9
Component Functions	10
Take control PCB	10
2 Channel Analog Fader PCB	10
ANA-2-DMX Scene Processor PCB	10
System Design Considerations	11
Place HHR or DMX-512 IN jacks near DMX stations	11
Power Supply Requirements	11
Current Calculation Examples:	12
System Cable Requirements	13
Cross Referenced Analog Compatible Cable Types:	13
Cable Derating Requirements:	13
Eliminate Ground Loops	14
What is ground?	14
Keep COM and GND separate.	14
Make star or daisy chain connections.	14
DMX daisy-chain configuration rules:	14
DMX bridge rules:	14
Advanced topics	15
Use of blocking (steering) Diodes.	15
Addendum	16
Wiring Details	16
Jumper Settings	16
Preset Station DMX-512 Snapshot Record Procedure	17

Sample System Configurations 18
Multi-Purpose Room With A/V Control Booth 18
Small Church (All Analog Stations) 19
Theater With Houselights / Rehearsal Lights 20
Dual DMX-512 Bridge 21

Wiring Diagrams 22
1 Channel Analog Station (Cat. No. 001-RMB81-001) 22
2 Channel Analog Station (Cat. No. 002-RMB81-002) 23
3 Channel Analog Station (Cat. No. 003-RMB81-003) 24
4 Channel Analog Station (Cat. No. 004-RMB81-004) 25
5 Channel Analog Station (Cat. No. 005-RMB81-005) 26
6 Channel Analog Station (Cat. No. 006-RMB81-006) 27
8 Channel Analog Station (Cat. No. 007-RMB81-008) 28
10 Channel Analog Station (Cat. No. 008-RMB81-010) 29
12 Channel Analog Station (Cat. No. 009-RMB81-012) 30
Entry Station (Cat. No. 010-RMB81-021) 31
Panic Station (Cat. No. 011-RMB81-022) 32
4 Channel DMX-512 Station (Cat. No. 017-RMB81-104) 33
6 Channel DMX-512 Station (Cat. No. 018-RMB81-106) 34
12 Channel DMX-512 Station (Cat. No. 019-RMB81-112) 35
0-10V Analog Dimmer 36

Warranty 38
LIMITED TWO YEAR WARRANTY AND EXCLUSIONS 38

SYSTEM OVERVIEW

Remember When ...

Remember when anyone could add a house light channel or a submaster to a lighting control system by wiring a slide pot to a diode and attaching it to which ever dimmers they wanted to control? Remember when control stations could be set up as independents, or group them with masters all without having to have a lap top, memorize DMX-512, know Windows 95 or battle the great configuration labyrinths envisioned by dyslexic software engineers? Everything was modular and simple. There was not a central "brain" that required programming, and there was not the hidden central processor costs and LAN limitations of most conventional architectural control systems.

Welcome Back to Simplicity.

This control system uses 3 small printed circuit board and 2 standard control protocols – DMX-512 and 0-10VDC as tools to create complex configurations in the simplest and least expensive way.

The three PCB's are:

- An on/off Take Control card
- A break-away, configurable, 0-10 VDC fader board.
- A 6 Channel 0-10VDC to DMX512 Scene Processor.

What experience is Prerequisite?

The only principles a designer needs to understand is:

- Take Control
- Master
- Slave
- Independent
- Snapshot DMX stream
- Pile-On (highest takes precedence)

Previous experience with 0-10VDC, diode patching and/or DMX-512 control protocols and control wiring is helpful, but not essential.

What is needed?

- 0-10 VDC or DMX-512 Dimmers/Ballast's
- A DMX-512 Control Console for developing Scenes (DMX stations only)
- A +12to +16 VDC Power Supply or Analog Stations (This power supply is not required when used in conjunction with a DMX Station. See page 3 for current requirements)
- 10V/5VA bell transformer for DMX Stations (The DMX station will provide 150mA of +V to drive several Analog Stations).

User Guide

- Standard NEMA Gang Boxes
- Imagination

What is not needed?

- A PC, DOS, Windows. Configuration files, disks or download cables. Station thumbwheel settings, A central processing cabinet. Lots of patience.

CONTROL STATION OPERATION

Play Mode

Action	➔	Result
<ul style="list-style-type: none"> • Press the ON/OFF (Panic) button to activate the station. 	➔	The LED will light, indicating the station is active. An Entry or Panic station will automatically activate a scene.
<ul style="list-style-type: none"> • Adjust Master Fader if applicable. controls all channel levels. 	➔	The Master Fader Proportionally
<ul style="list-style-type: none"> • Adjust Channel Fader if applicable. 	➔	Channel Faders may control one light, a group of lights, or an entire scene.
<ul style="list-style-type: none"> • Press the ON/OFF (Panic) button to turn off the lights. 	➔	The lights will fade out and the LED will turn off.

DMX Snapshot Record Mode

(For DMX control stations only)







Action	➔	Result
<ul style="list-style-type: none"> • Insure JP1 Jumper is out on ANA2DMX Processor 	➔	The remove jumper on JP1 puts the Processor in DMX Snapshot mode.
<ul style="list-style-type: none"> • Insure Record Lock is off. 	➔	Record Lock disables any attempt to record scenes, D19 LED on ANA2DMX Processor will be Orange if able to record. Green if unable to record.

NOTE

Record Lock can be activated any of 3 ways:

1. Jumper JP1 shorted on 2 Channel Analog PCB on station.
2. Jumper JP2 shorted on ANA2DMX processor on station.
3. REC LOCK terminal on ANA2DMX processor on station driven with external +10VDC signal.

User Guide

- Turn off all control stations.  This insures only console levels will be recorded.
- Bring up the desired scene or look on  This is the scene that will be the main console recorded.
- Go to the DMX control station.  This gets the station ready to be put in record mode.
Slide Master Fader all the way up to full.
Slide all the channel faders down to out.
- Push and hold the ON/OFF button when turning the station “ON”  The Green LED will light.
- Count to 5 (approximately 5 seconds) (continue to hold the ON/OFF Button).  This puts the Station into record mode. (LED on ANA2DMX PCB turns green).
- Slide the Channel Fader up to full where the scene is to be recorded. (continue to hold the ON/OFF Button).  This snapshots the DMX-512 data stream, saving the entire scene under the proportional control of the channel fader that slid to full. The LED on the ANA2DMX Processor will blink red when it is finished recording the scene.
- Release the ON/OFF button.  This exits Record Mode.

Record Example:









To record scene into fader 1: (assuming REC LOCK is off)

Action

- Slide master fader to full, channel faders to out.
- Push & hold ON/OFF button when it goes from OFF to ON.
- Count out loud while continuing to hold ON/OFF button:
“One one thousand”
“Two one thousand”
“Three one thousand”
“Four one thousand”
“Five one thousand”
- Slide channel fader 1 to full.
- Release ON/OFF button.

DMX Channel Mode

(for DMX control stations only)

Action		Result
<ul style="list-style-type: none"> • Install Jumper JP1 on ANA2DMX PCB. 		This puts processor in channel mode.
<ul style="list-style-type: none"> • Dial up the starting address on rotary Switches SW1, SW2, & SW3 		This selects the DMX start address for fader A1.
<ul style="list-style-type: none"> • For fader channel single pattern operation, remove JP4. 		Faders 1-6 will respond to DMX channels 1-6. (assuming start address – 001).
<ul style="list-style-type: none"> • For fader channel dual wraparound Pattern operation, install JP4. 		Fader 1 controls DMX channels 1 & 7; Fader 2 controls DMX channels 2 & 8; Fader 3 controls DMX channels 3 & 9; Fader 4 controls DMX channels 4 & 10; Fader 5 controls DMX channels 5 & 11; Fader 6 controls DMX channels 6 & 12; (assuming start address = 001) (and 6 channel operation – see JP6)
<ul style="list-style-type: none"> • For highest takes precedence fader operation, remove JP5 		The fader channel will pile-onto the appropriate incoming DMX channels.
<ul style="list-style-type: none"> • To replace the incoming DMX channel levels with the fader levels, install JP5 		The fader channels will replace the appropriate incoming DMX channel levels.
<ul style="list-style-type: none"> • For 4 channel operation install JP6 on ANA2DMX Processor. 		This puts the processor in 4 channel on wraparound mode.
<ul style="list-style-type: none"> • For 6 & 12 channel operation remove JP6 on ANA2DMX Processor. 		This puts the processor in 6 channel on wraparound mode.

COMPONENT FUNCTIONS

Take control PCB

The take control PCB has a single switch for ON/OFF operation. The take control PCB requires +12 to +16 Volts DC 25mA connected across +V and common to operate. The PCB provides a regulated +10.6 VDC source when the ON/OFF switch is activated (turned on) and 0 Volts when off.

Pressing the ON/OFF switch sends a +10VDC pulse out the T/C terminal on TB1 and down the T/C wire to reset any other stations connected to the T/C wire and TB1. The Take Control line determines and connects the stations you want to respond in a group. Not connecting the take control line makes the stations or groups respond independently of each other.

When the ON led is lit, +10VDC is available on the VOUT terminal. The VOUT signal can be used to activate a single analog channel, or when used with prep cable PRP-31316-02, it can be used to activate several channels at once. The VOUT signal's most common application is to implement Panic or Entry Stations. See the Wiring Diagrams for Entry or Panic stations for more details.

2 Channel Analog Fader PCB

The Fader PCB is a breakable PCB array that can be easily be configured for 1-12 channels with or without a master fader. The input/output bussed connector scheme of J1/P1 passes DC power, analog 0-10V levels, and take control across the control station to the terminal block on the take control card, or to a header for the ANA-2-DMX PCB. All 0-10V analog channels are buffered by an op-amp and diode blocked before leaving the PCB.

ANA-2-DMX Scene Processor PCB

The ANA-2-DMX PCB utilizes six 0-10 VDC analog control inputs to proportionally drive 6 DMX submaster scenes that pile-onto each other and to the incoming DMX signal whether active or inactive. To record a scene, first bring up the desired look on the console running to the DMX IN terminal. Next, slide the master to full and the channels to off. Push and hold the ON/OFF button to ON for about 5 seconds on the station, putting the station in record mode. Finally, slide the fader up to full for the channel you wish to record the scene into. As long as the record lockout is not enabled, the scene will be saved onto that channel, and will proportionally fade relative to the slide pot. For user convenience, the record lockout function which disables re-recording scenes is available on the DMX terminal Block, as a jumper on the ANA-2-DMX PCB itself, and also as a jumper on the 2 channel fader PCB. Record lock is perfect for setting up house light channels or looks, and then disabling the record function for patrons. A DMX bypass relay is provided in the event of a power supply failure.

SYSTEM DESIGN CONSIDERATIONS

Place HHR or DMX-512 IN jacks near DMX stations

Place a Hand Held Remote Jack from the control console or a DMX-512 IN Jack where the console could be plugged in near any station that will be used to snapshot scenes on a frequent basis. This way scenes can be activated from the console in the same place they are to be recorded.

Power Supply Requirements

DMX Station Current Supply:

(+V/COM power supply source for a single station connected to a single 10V/5VA transformer)

Station Type	Supply Current	Catalog No.	# of Gang
4 Channel DMX Station	150mA	017-RMB81-104	4
6 Channel DMX Station	150mA	018-RMB81-106	5
12 Channel DMX Station	100mA	019-RMB81-112	8
12 Channel DMX station connected to qty 2-10V/5VA transformers. (transformers connected to separate AC1/AC2 inputs)			
	250ma.		

NOTE

The +V/COM current through a DMX station should not exceed 750mA.

Analog Station Current Demands:

+V power supply requirements for a single station (+12 to +16 VDC)

Station Type	ON	OFF	Catalog Bo.	# of Gangs
Entry Station	25 mA	5mA	010-RMB81-021	1
Panic Station	25 mA	5mA	011-RMB81-022	1
1 Channel Analog	30 mA	5mA	001-RMB81-001	2
2 Channel Analog	30 mA	5mA	002-RMB81-002	2
3 Channel Analog	35 mA	5mA	003-RMB81-003	4
4 Channel Analog	40 mA	5mA	004-RMB81-004	4
5 Channel Analog	45 mA	5mA	005-RMB81-005	5
6 Channel Analog	50 mA	5mA	006-RMB81-006	5
8 Channel Analog	60 mA	5mA	007-RMB81-008	6
10 Channel Analog	70 mA	5mA	008-RMB81-010	7
12 Channel Analog	80 mA	5mA	009-RMB81-012	8

Current Calculation Examples:

3 Grouped Stations

Current demand calculation for qty 3, 6 channel stations connected in a group: T/C connected between stations, therefore only one station can be on at a time.

$$+V \text{ Amps} = 50\text{mA (station 1)} + 5\text{mA (station 2)} + 5\text{mA (Station 3)} = 60\text{mA}$$

3 Independent Stations

Current demand calculation for qty 3, 6 channel stations connected independently; T/C not used. All 3 could be on at the same time.

$$+V \text{ Amps} = 50\text{mA (station 1)} + 50\text{mA (station 2)} + 50\text{mA (Station 3)} = 150\text{mA}$$

ELIMINATE GROUND LOOPS

What is ground?

This control system, like most other control systems requires a common reference for the electronics to function properly. This reference is typically denoted as Common or Ground. Control voltages are measured with respect to this ground reference, just like the height of a person would normally be measured with respect to the ground they are standing on. Without a proper common reference, the electronics can not make accurate voltage measurements, and therefore will not function correctly.

Keep COM and GND separate.

The ANA 2DMX PCB has 2 different control references. COM (Analog Common) and GND (Digital Ground). The two are nearly the same, except COM is the reference for all the analog control levels and GND (digital ground) is the reference for the digital electronics and the incoming power supply. COM and GND should never be connected together with external wiring. Never place This control systems control lines in conduit with other wires, or flickering problems could occur.

Make star or daisy chain connections.

In this electronics system, it is important for all the COM signals to be connected in a start or daisy-chain configuration, as opposed to a ring or loop configuration. The reason is that a ring or loop configuration usually acts like a big antenna which is excited and aggravated by adjacent power lines. Apply the following rules:

DMX daisy-chain configuration rules:

(multiple DMX Stations connected in serial along one DMX-512 line)

1. Do not connect COM between DMX stations.
2. Use a separate power supply for each DMX station.
3. Daisy-chain the DMX-512 signal as normal, connecting the shield drain to DGND.

DMX bridge rules:

(2 or more DMX Stations tied together with COM, each processing its' own DMX-512 line)

1. Tie stations together using COM
2. Use a separate 10V/5VA transformer for each DMX Station
3. Connect the shield drain wire to DGND on the DMX-1 station.
4. Do not connect the shield drain wire to DGND on additional DMX stations (DMX-2, 3, 4 _). Leave the DGND Terminals or DMX IN/OUT empty. The DMX shield can be passed through the station location, but it should not touch or connect to anything in the box.

ADVANCED TOPICS

Use of blocking (steering) Diodes.

What is a Diode?

A diode is a one-way valve. It allows current to flow in a forward direction, but not in a reverse direction. The input is the anode, or un-banded end of the part; and the output is the cathode, or banded end of the part. When the input (anode) is at a voltage potential higher than the output (cathode), current will pass from the input to the output until it fills up the output connection to nearly the same voltage level as available on the input connection. When the output voltage rises higher than the input voltage, the part shuts off

Analog Channel Grouping

Use 1N4148 or 1N914 diodes to select multiple Analog Channels to be controlled by a single fader, Entry, or Panic station. This is done by connecting the banded end (cathode) of the diodes to each of the Analog Channels to be controlled. Tie the un-banded ends together, and to the single VOUT or A (1-6) single fader control line that is to control the channels. The diodes will keep the channels to be controlled separate except when the source channel is active. The 1N4148 or 1N914 is considered a signal diode. It is excellent for quick linear response in low-current applications, however it has a tendency to fail in high current applications.

Master/Slave Take Control

Use 1N4004 diodes to create Master/Slave take Control relationships between control stations. This is implemented by attaching the un-banded end (anode) to the master station, and the banded end (cathode) to the slave station(s). The master station will now be able to take control away from the slave station(s), but the slave station(s) will not be able to take control away from the master station. The master station will act as an independent from the slave(s) stations point of view. The slave station will also be unable to record presets if the master station is a DMX station, as the record operation is a function of the take control circuit. The 1N4004 is considered a rectifier diode, and is excellent for high-current applications, like the take control circuitry, but it would perform poorly as a signal diode, because it requires significant current to operate properly.

ADDENDUM

Concerning New REMEMBRANCE Preset Stations:

Wiring Details

8 Preset Station:
(8-1028, 8-1148, 8-1188)

Refer to 8 Channel Analog Station Wiring Diagram and Colortran Colortran Production Drawings for connection details of this Preset Station in your specific system.

4 Preset Station:
(8-1024, 8-1144)

Refer to Colortan Production Drawings for connection details of this Preset Station in your specific system. Note the following control wire mapping.

Station Terminal A2 = Preset #1 (usually System A1)
Station Terminal A3 = Preset #2 (usually System A2)
Station Terminal A6 = Preset #3 (usually System A3)
Station Terminal A7 = Preset #4 (usually System A4)
Station Terminal +V = +V for system
Station Terminal COM = COM for system
Station Terminal T/C = T/C as applicable in system design.

NOTE

Connect Station Terminal A1 to Station Terminal A2 on 4 preset stations to activate Preset 1 on power up.

Jumper Settings

- JP3 IN:** Enable Snapshot Record feature from this Station DMX-512 Scene Snapshot Record may be enabled if T/C is connected to recording processor (either i series e control module, or REMEMBRANCE ANA2DMX processor). The station will also activate presets, and take control away from other stations connected to its' T/C line. Refer to Colortan Production Drawings for connection details, and refer to the snapshot record procedure below for operational details. The "OFF" LED will stay red while the "OFF" switch is pressed.
- JP3 OUT:** Disable Snapshot Record from this station. The station will only activate presets, and take control away from other stations connected to its' T/C. Line. The OFF LED will pulse red when the "OFF" switch is pressed.
- JP5 IN:** Activate Preset 1 on power up. Preset 1 will automatically turn on when power is applied to the station.
- JP5OUT:** Activate OFF on power up. All preset will be off when power is applied to the control station.

Preset Station DMX-512 Snapshot Record Procedure

1. JP3 must be installed on this station.
2. Activate DMX-512 scene from control console or DMX-512 portion of control station. On i series e racks, or i series e Quad racks, a relative fade time for the preset may be assigned by setting DMX channels 511 and 512 to the same control level as follows:
 - Full = 90 seconds
 - 90% = 9 seconds
 - 80% = 8 seconds
 - 70% = 7 seconds
 - 60% = 6 seconds
 - 50% = 5 seconds
 - 40% = 4 seconds
 - 30% = 3 seconds
 - 20% = 2 seconds
 - 10% = 1 seconds
 - 0% = Instantaneous
3. Turn off all other control sources, so only DMX-512 generated scene is active.
4. Press and hold the "OFF" Button. The "OFF" LED will turn and stay red.
5. Continue pressing the OFF switch for at least 5 seconds. If the preset station is connected to an i series e rack, the lights will dim when the snapshot mode has been enabled. If the station is connected to an ANA2DMX processor, wait an extra second or two to insure that the processor is in snapshot mode.
6. While holding the OFF switch, press the preset switch where you would like the DMX512 scene stored.
7. Continue to hold the OFF button for another second or until the lights return to their normal levels.
8. Release the OFF button.

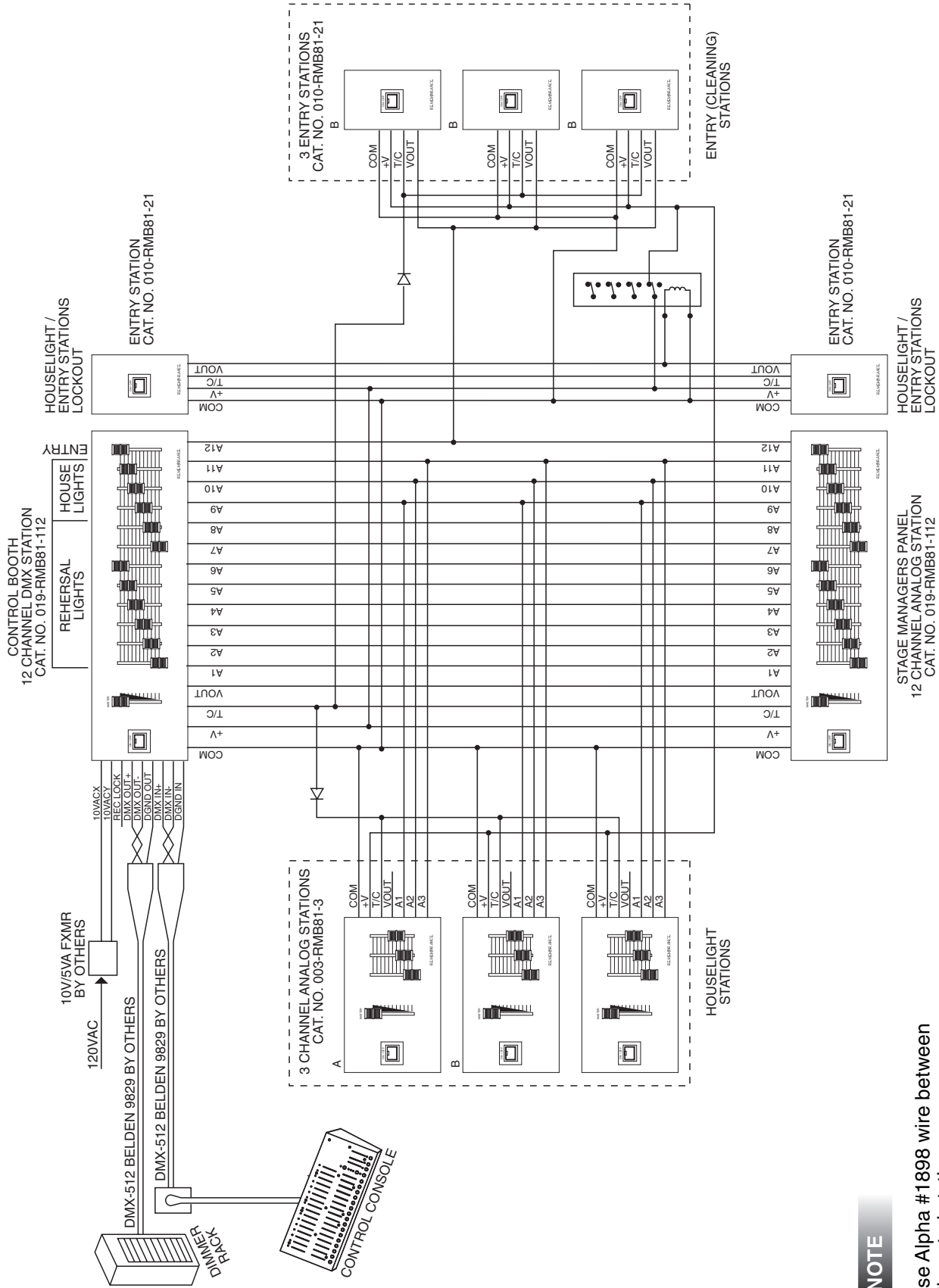

NOTE

Use Alpha #1898 wire between all control stations.

Theater With Houselights / Rehearsal Lights

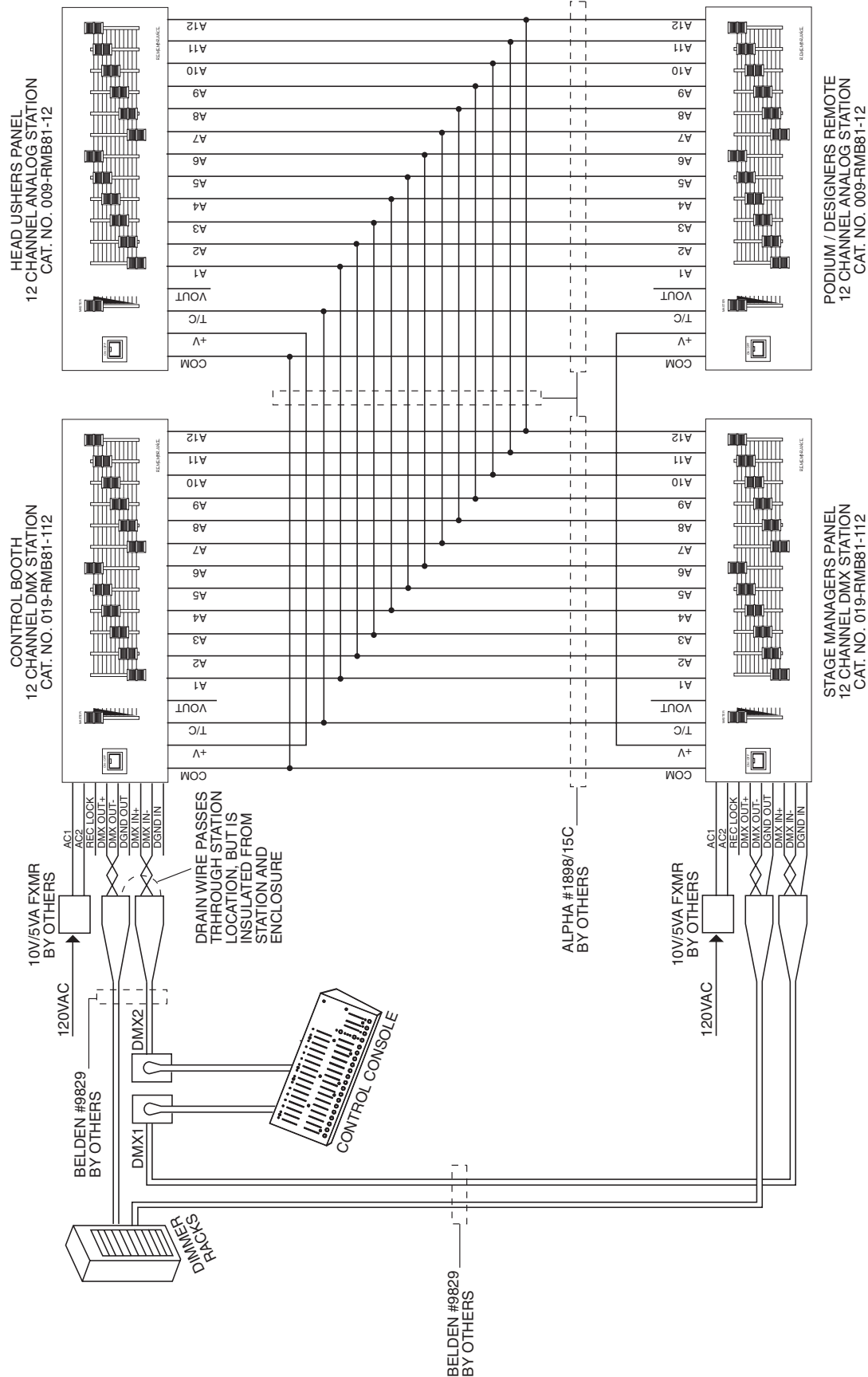

NOTE

Use Alpha #1898 wire between all control stations.

Dual DMX-512 Bridge

WIRING DIAGRAMS

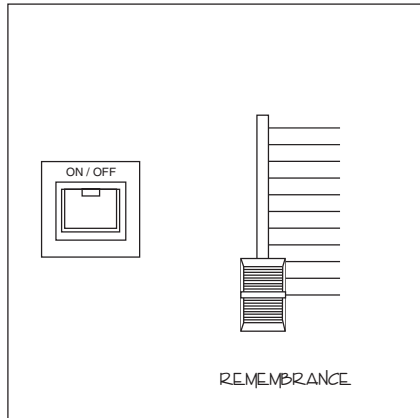

FRONT VIEW

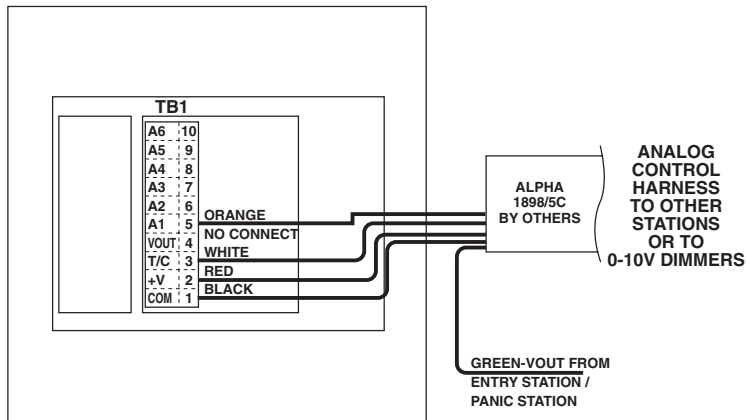

REAR VIEW

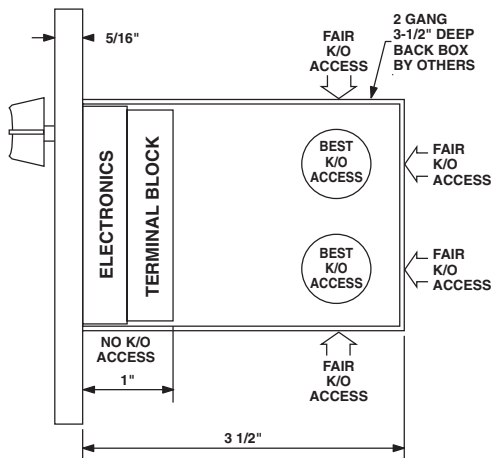

SIDE VIEW

1 Channel Analog Station (Cat. No. 001-RMB81-001)

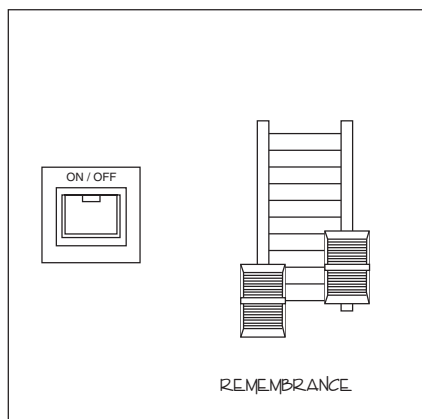

FRONT VIEW

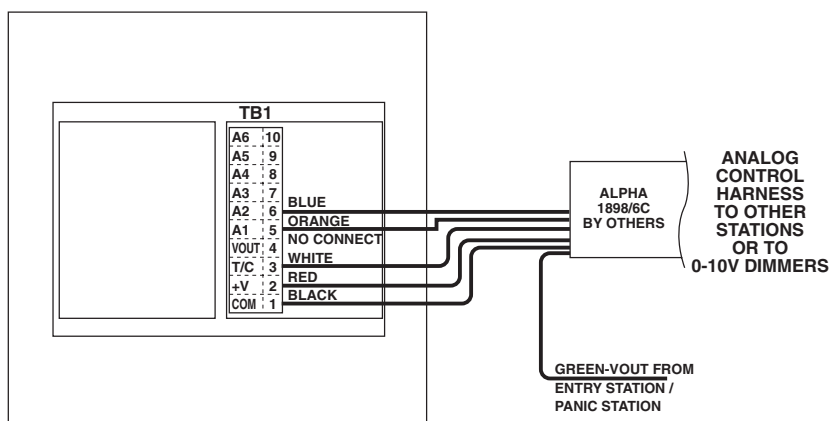

REAR VIEW

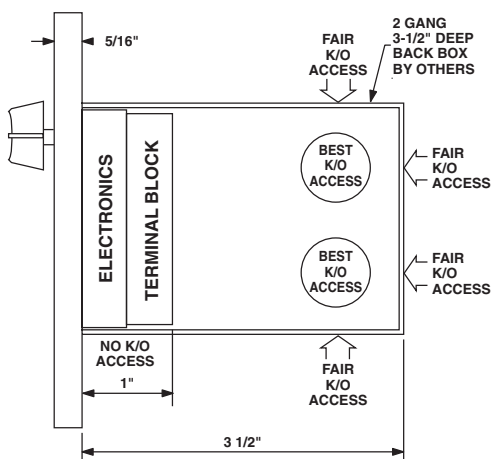

SIDE VIEW

2 Channel Analog Station (Cat. No. 002-RMB81-002)

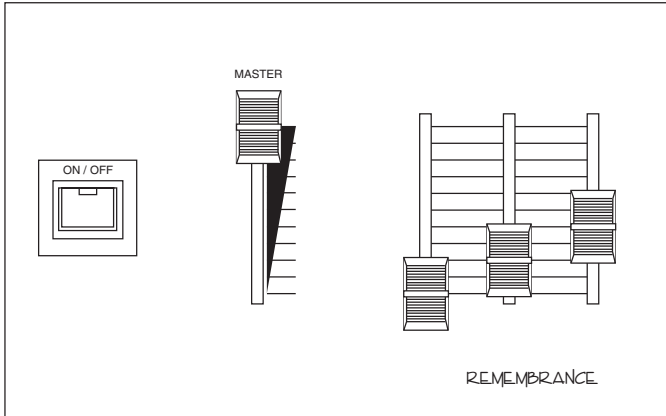

FRONT VIEW

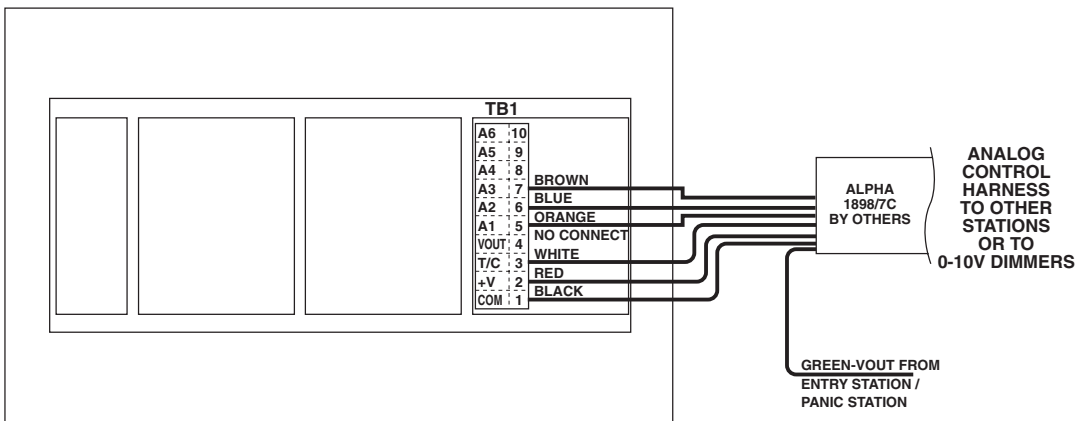

REAR VIEW

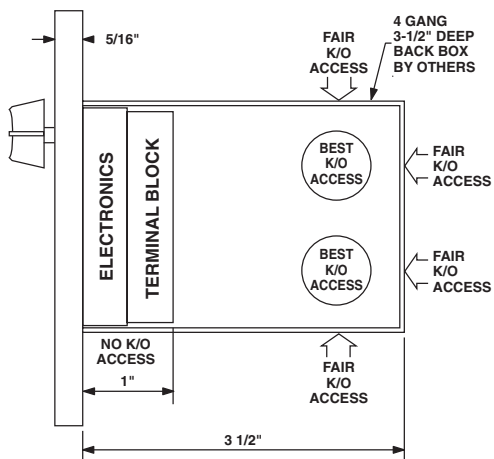

SIDE VIEW

3 Channel Analog Station (Cat. No. 003-RMB81-003)

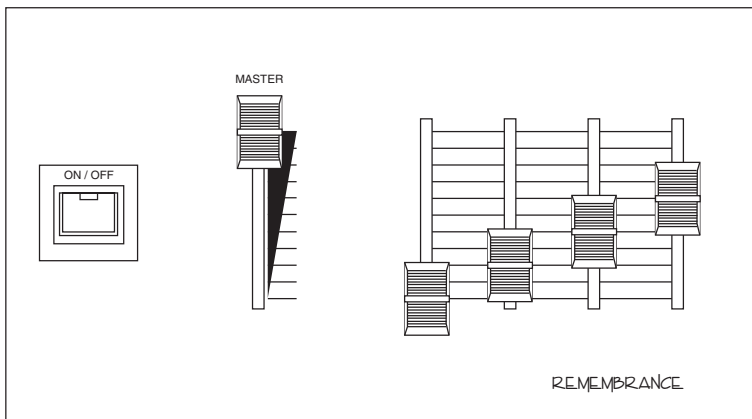

FRONT VIEW

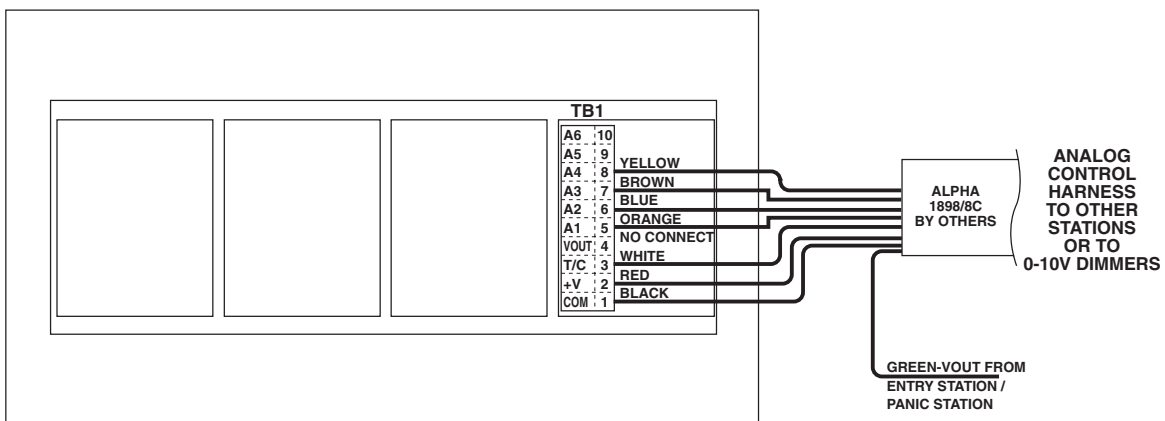

REAR VIEW

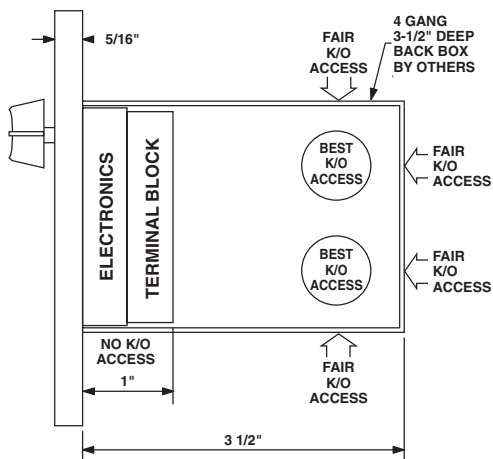

SIDE VIEW

4 Channel Analog Station (Cat. No. 004-RMB81-004)

User Guide

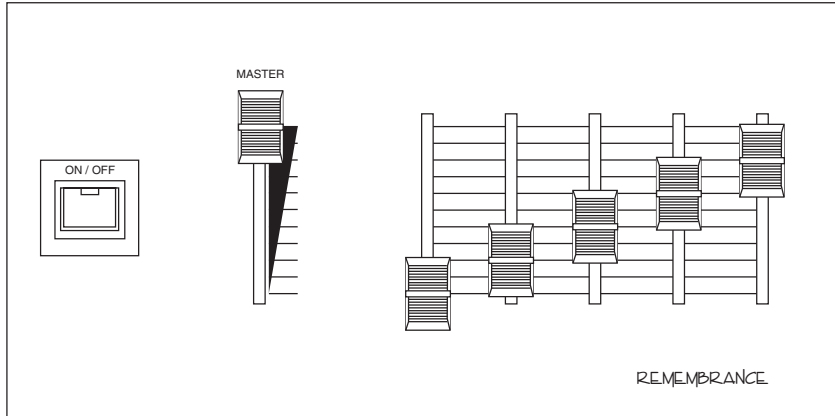

FRONT VIEW

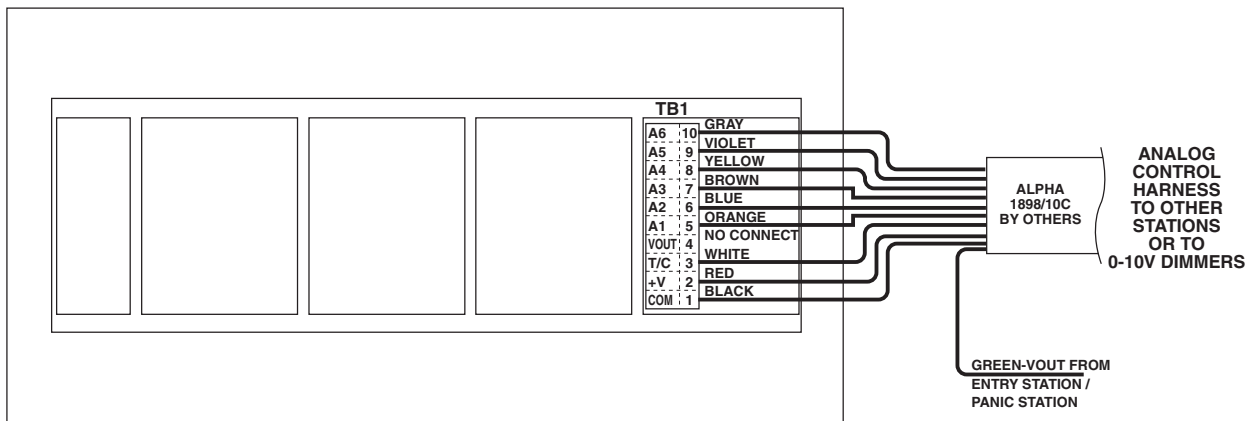

REAR VIEW

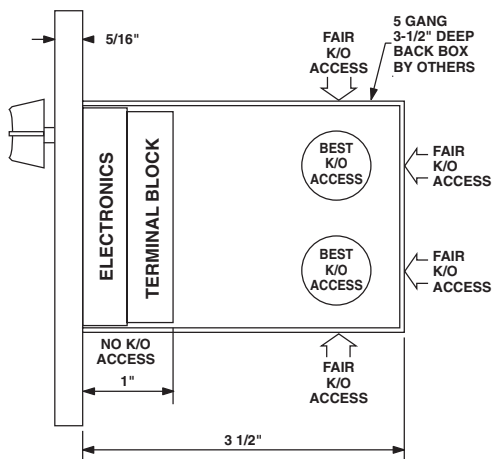

SIDE VIEW

5 Channel Analog Station (Cat. No. 005-RMB81-005)

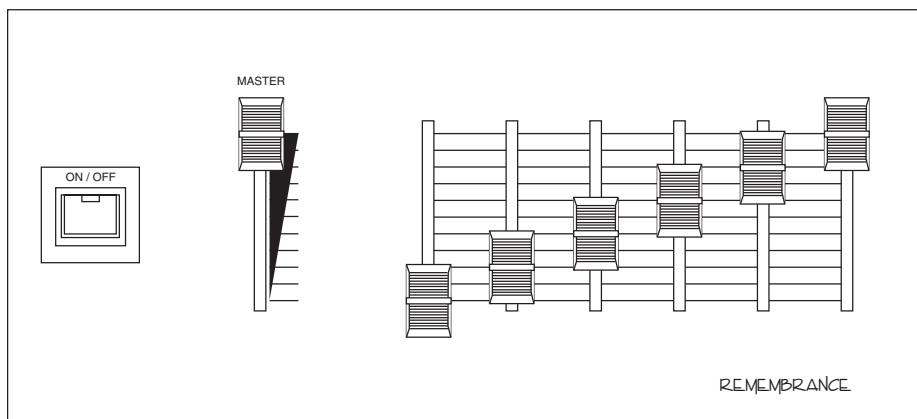

FRONT VIEW

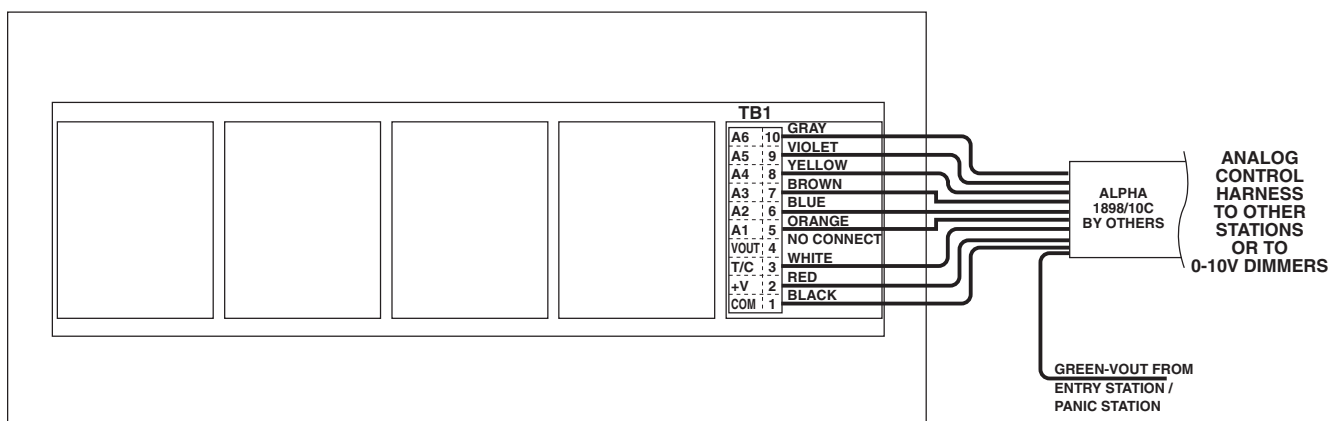

REAR VIEW

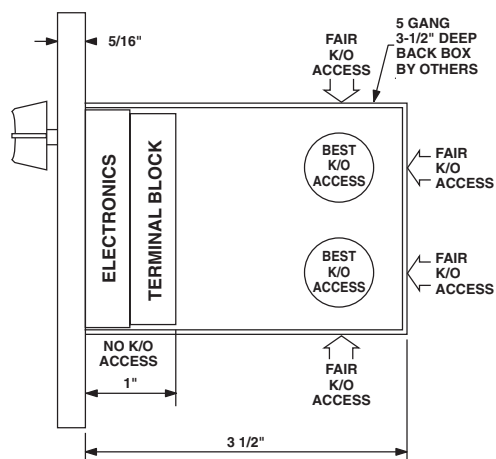

SIDE VIEW

6 Channel Analog Station (Cat. No. 006-RMB81-006)

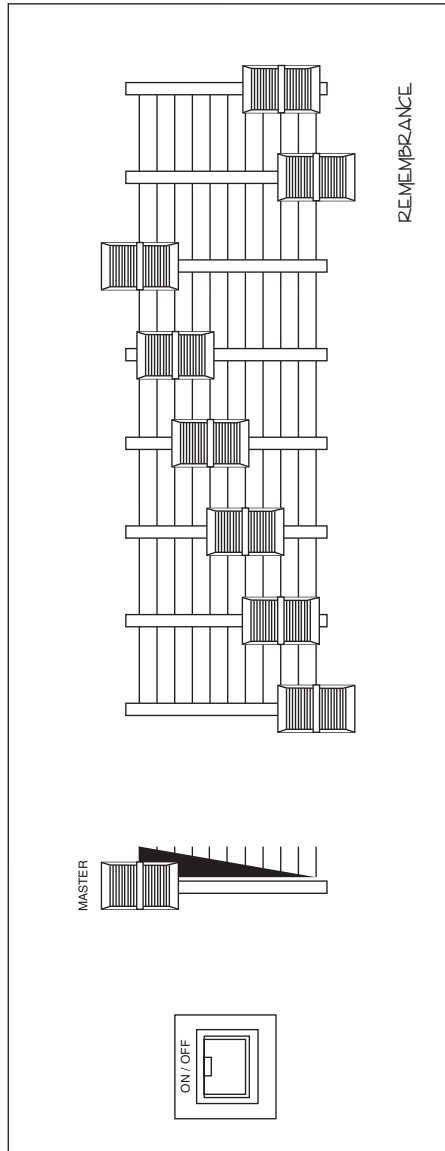
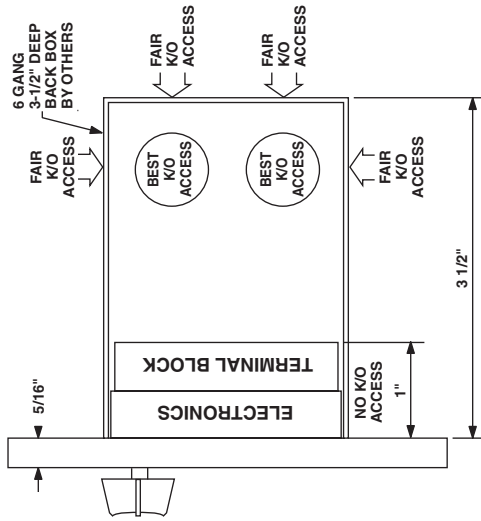

FRONT VIEW

SIDE VIEW

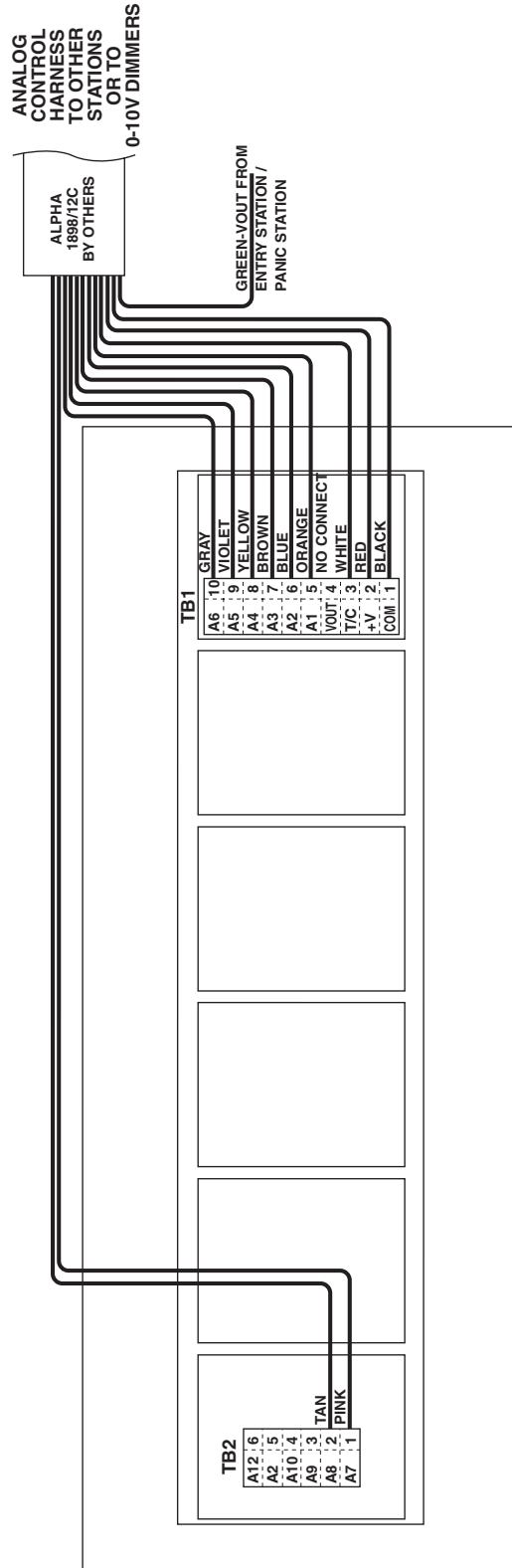

REAR VIEW

8 Channel Analog Station (Cat. No. 007-RMB81-008)

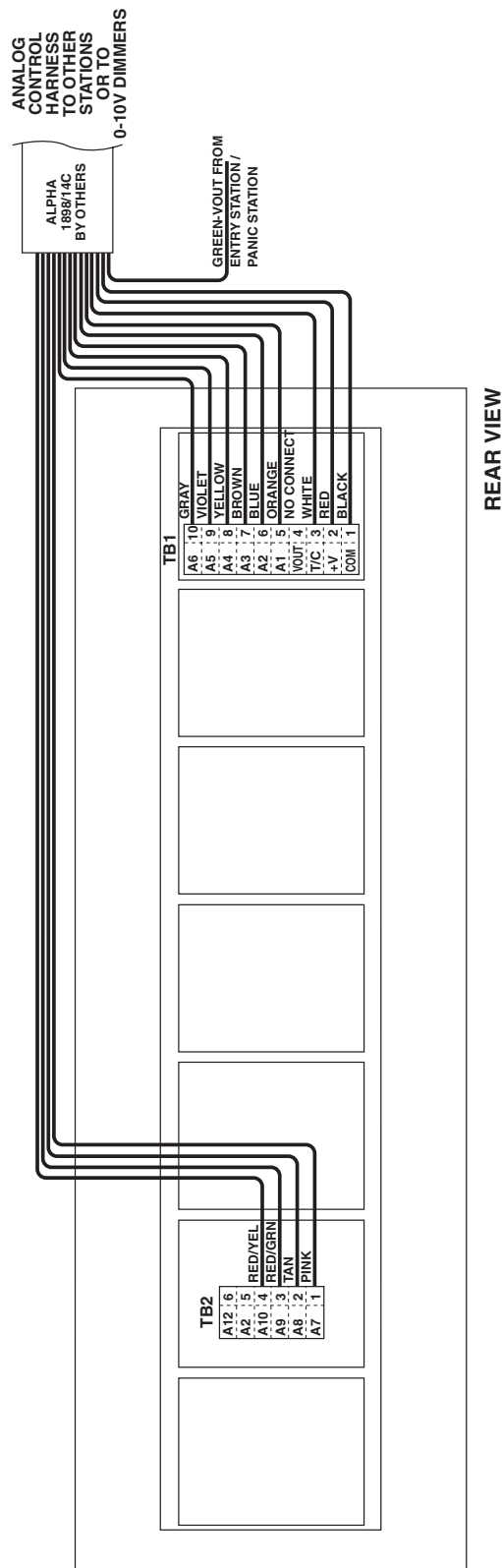
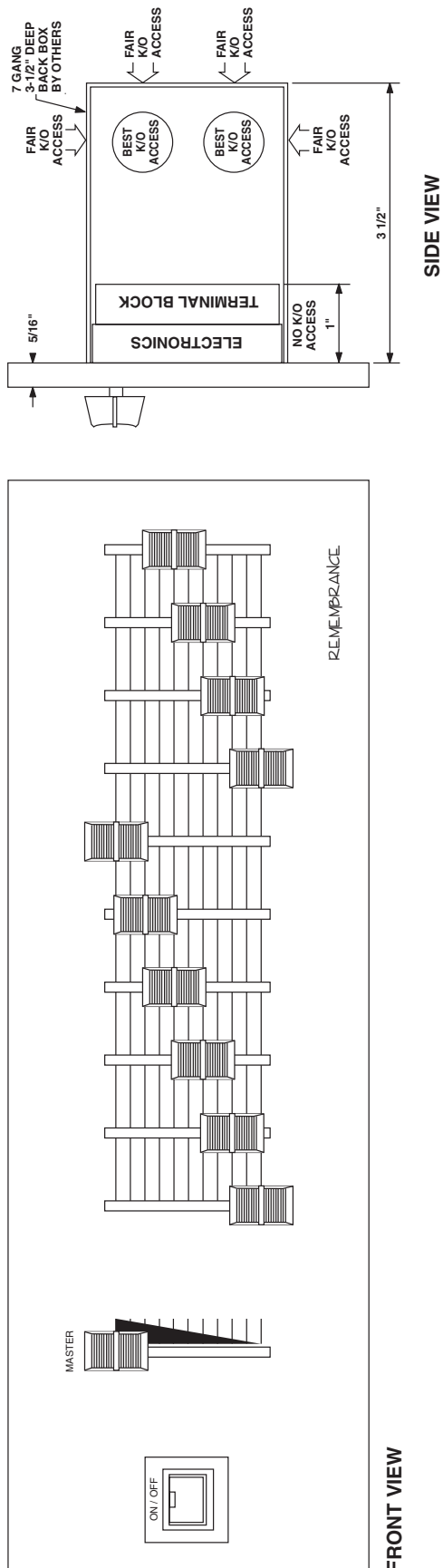

10 Channel Analog Station (Cat. No. 008-RMB81-010)

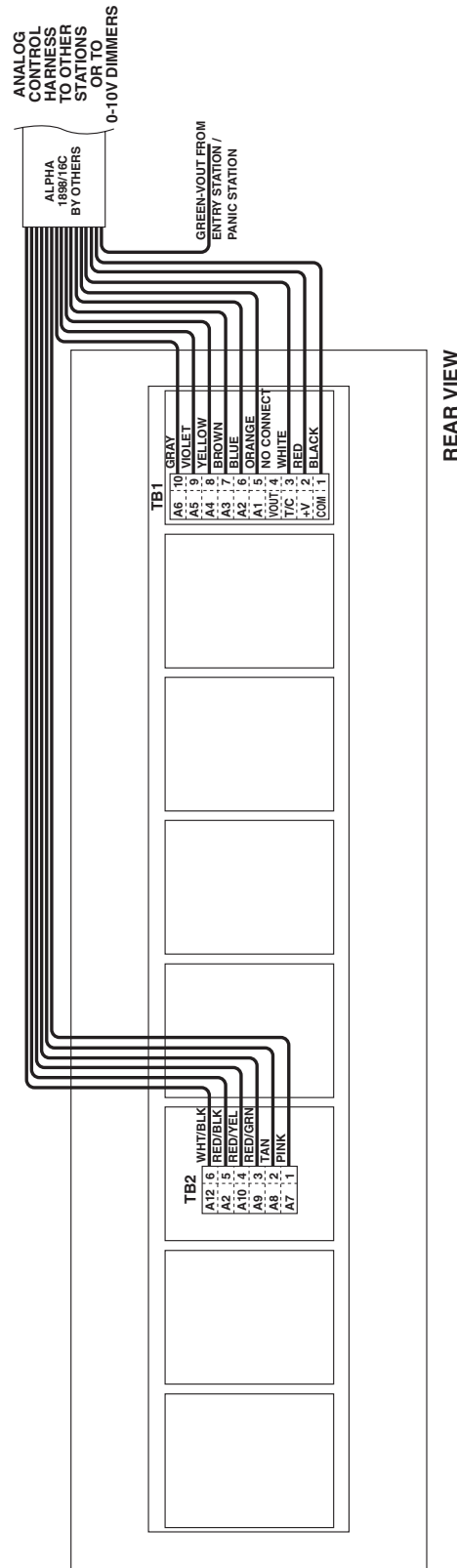
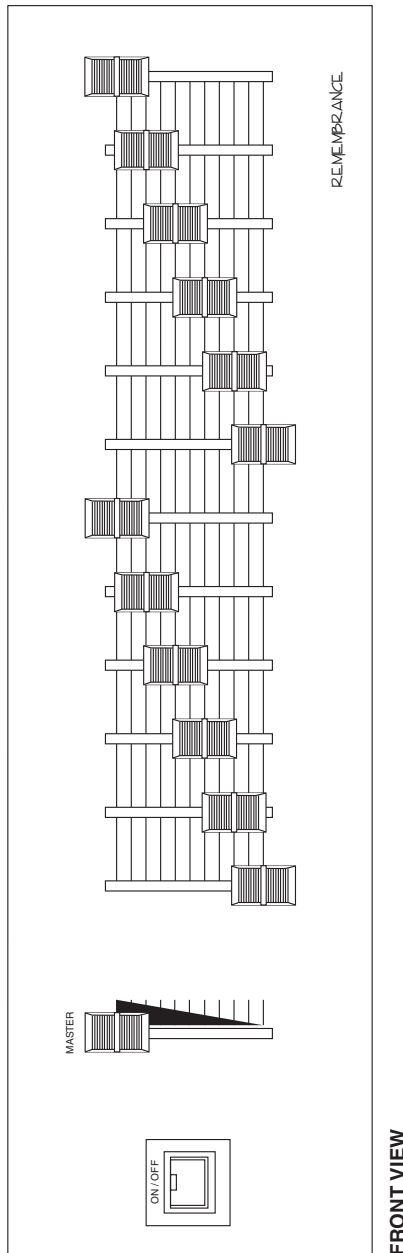
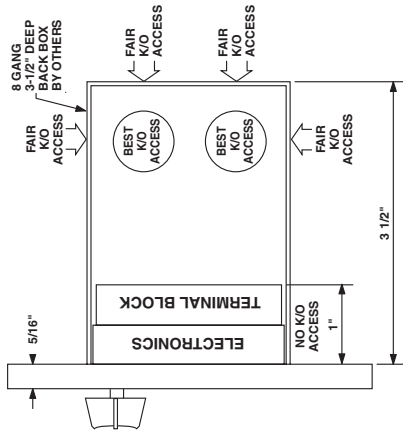

12 Channel Analog Station (Cat. No. 009-RMB81-012)

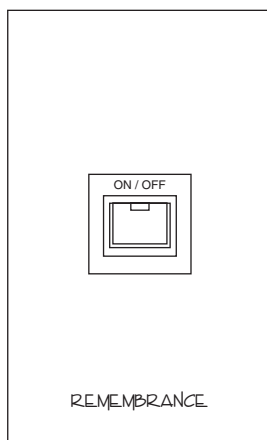

FRONT VIEW

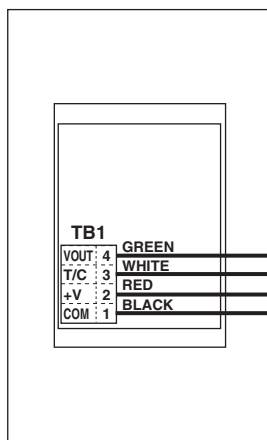

REAR VIEW

ANALOG / DMX STATION TERMINATION REFERENCE

PRP-31316-02 IS CALLED OUT SEPERATELY. SHOWN HERE FOR REFERENCE ONLY.

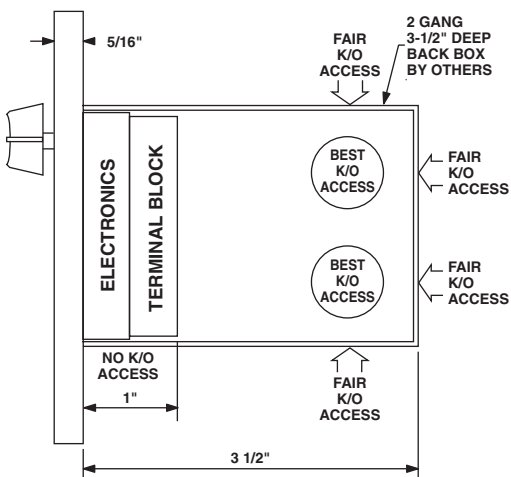
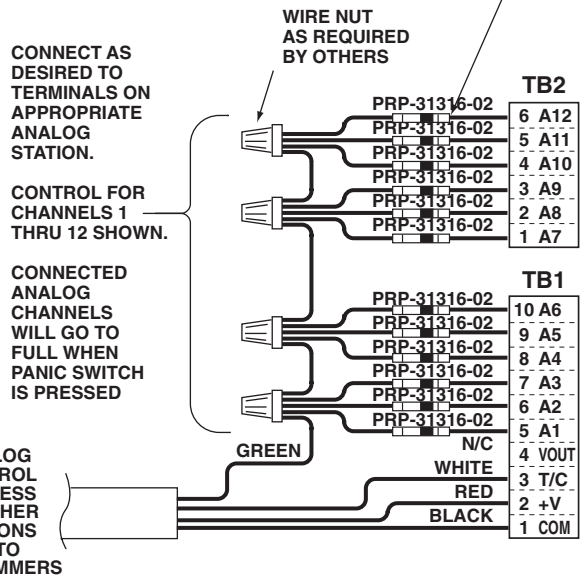

SIDE VIEW

Entry Station (Cat. No. 010-RMB81-021)

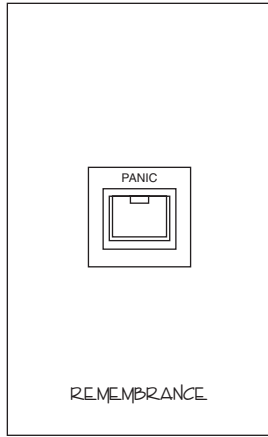

FRONT VIEW

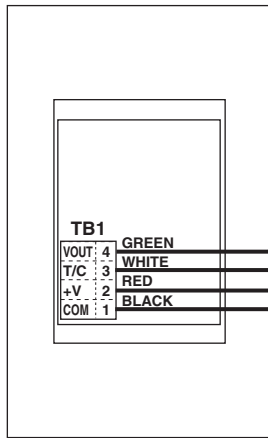

REAR VIEW

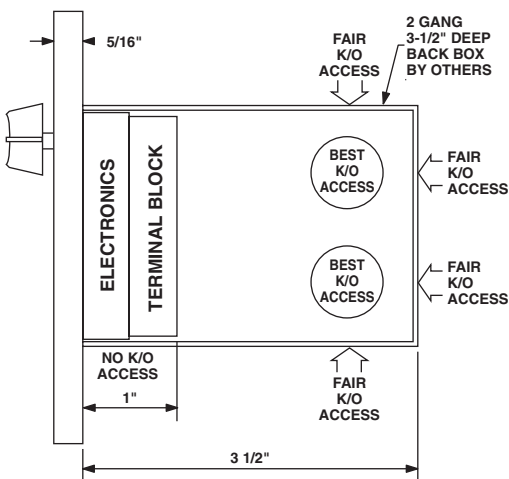
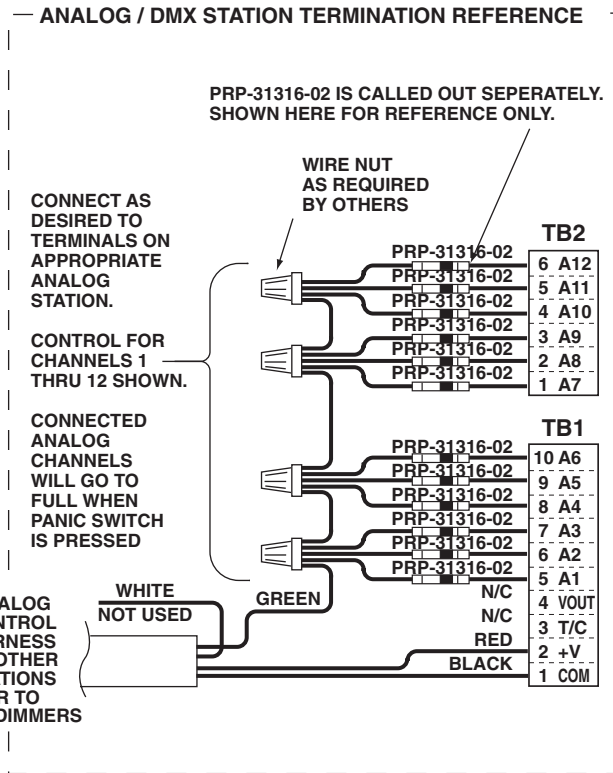

SIDE VIEW

Panic Station (Cat. No. 011-RMB81-022)

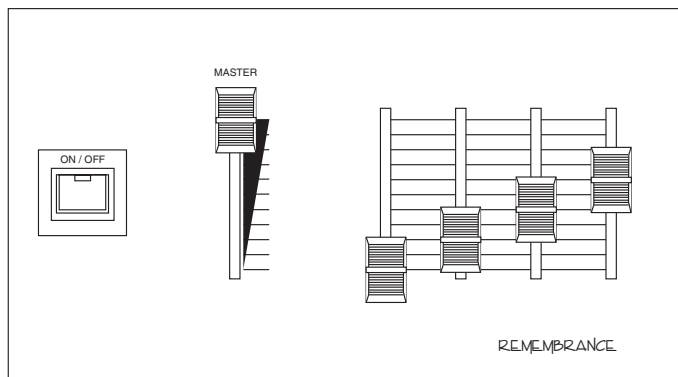

FRONT VIEW

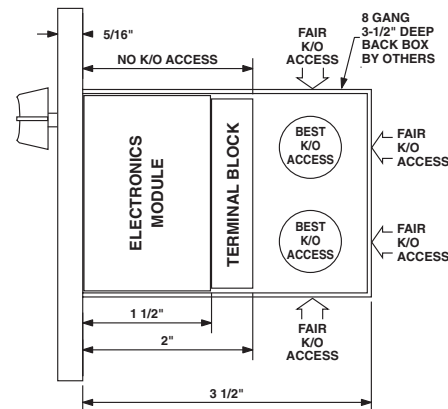

SIDE VIEW

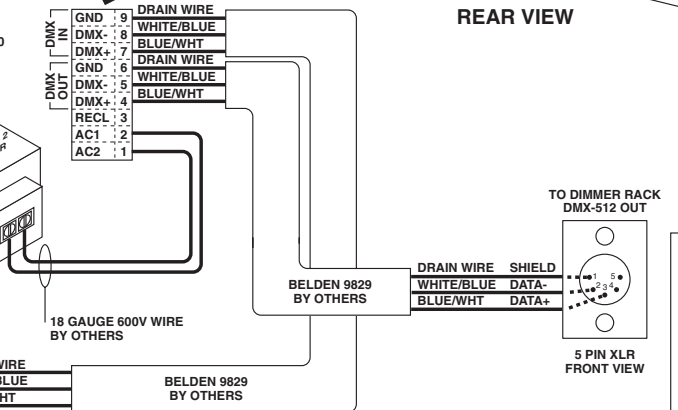
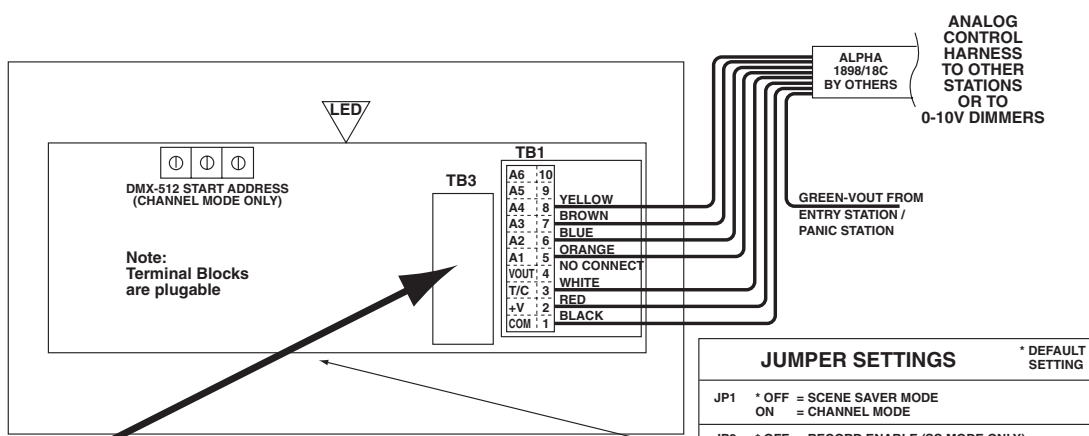

JUMPER SETTINGS		* DEFAULT SETTING
JP1	* OFF = SCENE SAVER MODE ON = CHANNEL MODE	
JP2	* OFF = RECORD ENABLE (SS MODE ONLY) ON = RECORD LOCKOUT (SS MODE ONLY)	
JP3	* OFF = STATION ALWAYS OUTPUTS DMX-512 ON = NO DMX OUTPUT WHEN STATION IS OFF	
JP4	* OFF = CHANNEL MODE SINGLE SEQUENCE ON = CHANNEL MODE DUAL REPEAT SEQUENCE	
JP5	* OFF = CHANNELS PILE ONTO DMX-512 IN ON = CHANNELS REPLACE DMX-512 IN LVLS.	
JP6	* OFF = 6 CHANNEL STATION ON = 4 CHANNEL STATION	
JP7	RESERVED	

DIAGNOSTIC LED FUNCTION	
BLINKING RED	= RECORD MODE
BLINKING YELLOW	= PLAY MODE WITH ACTIVE DMX-512 IN AND RECORD ENABLED
BLINKING GREEN	= PLAY MODE WITH ACTIVE DMX-512 IN AND RECORD DISABLED OR CHANNEL MODE
SOLID GREEN	= PLAY MODE WITH NO DMX IN AND RECORD DISABLED OR CHANNEL MODE
SOLID YELLOW	= PLAY MODE WITH NO DMX IN AND RECORD ENABLED

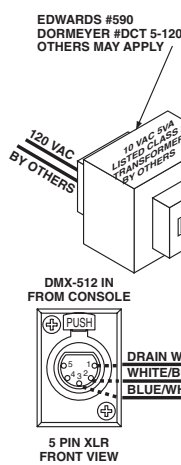

4 Channel DMX-512 Station (Cat. No. 017-RMB81-104)

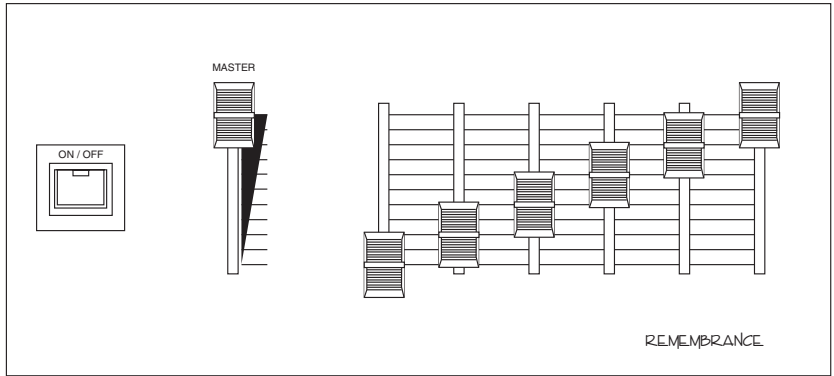

FRONT VIEW

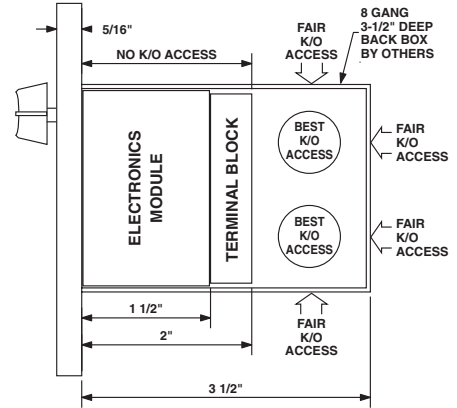

SIDE VIEW

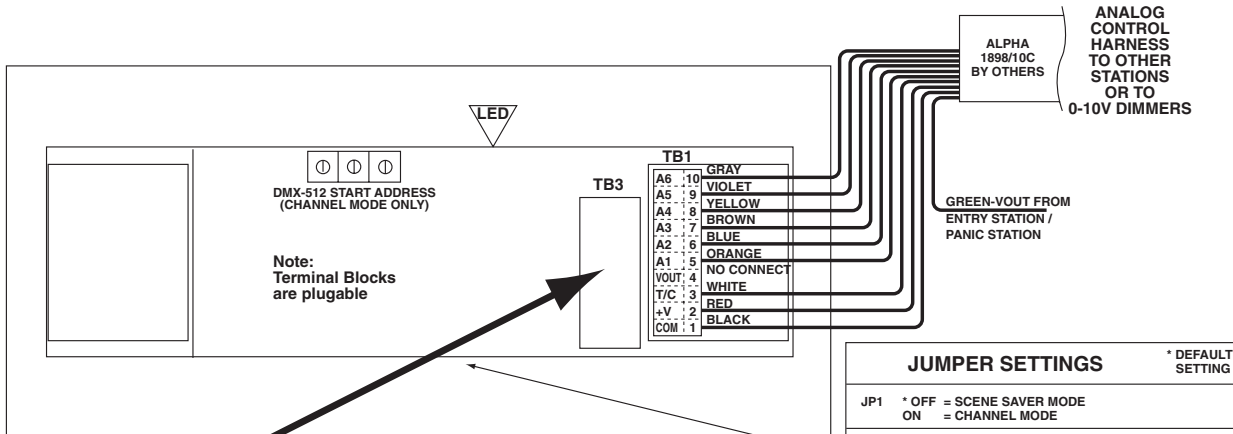

REAR VIEW

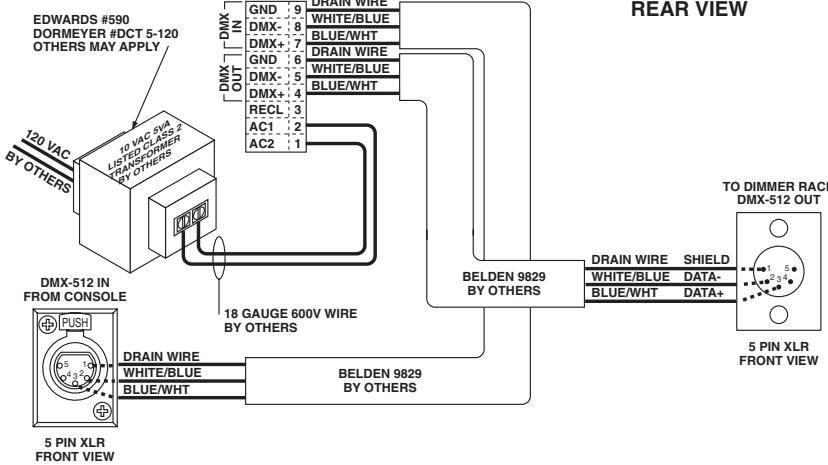

JUMPER SETTINGS		* DEFAULT SETTING
JP1	* OFF = SCENE SAVER MODE ON = CHANNEL MODE	
JP2	* OFF = RECORD ENABLE (SS MODE ONLY) ON = RECORD LOCKOUT (SS MODE ONLY)	
JP3	* OFF = STATION ALWAYS OUTPUTS DMX-512 ON = NO DMX OUTPUT WHEN STATION IS OFF	
JP4	* OFF = CHANNEL MODE SINGLE SEQUENCE ON = CHANNEL MODE DUAL REPEAT SEQUENCE	
JP5	* OFF = CHANNELS PILE ONTO DMX-512 IN ON = CHANNELS REPLACE DMX-512 IN LVLS.	
JP6	* OFF = 6 CHANNEL STATION ON = 4 CHANNEL STATION	
JP7	RESERVED	

DIAGNOSTIC LED FUNCTION	
BLINKING RED	= RECORD MODE
BLINKING YELLOW	= PLAY MODE WITH ACTIVE DMX-512 IN AND RECORD ENABLED
BLINKING GREEN	= PLAY MODE WITH ACTIVE DMX-512 IN AND RECORD DISABLED OR CHANNEL MODE
SOLID GREEN	= PLAY MODE WITH NO DMX IN AND RECORD DISABLED OR CHANNEL MODE
SOLID YELLOW	= PLAY MODE WITH NO DMX IN AND RECORD ENABLED

6 Channel DMX-512 Station (Cat. No. 018-RMB81-106)

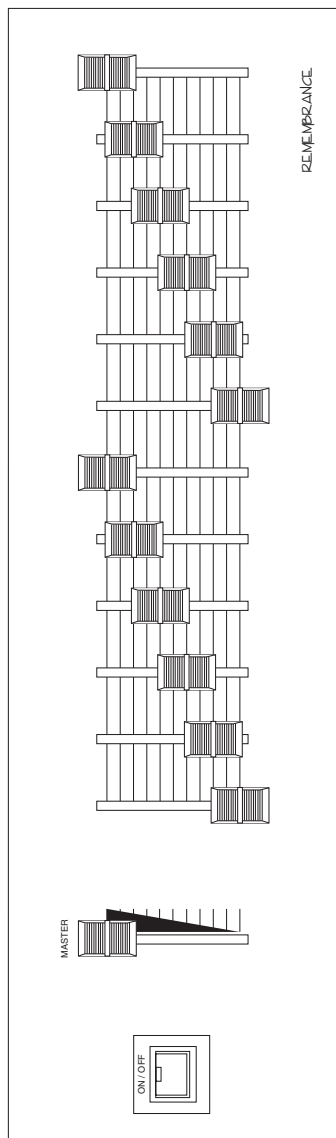
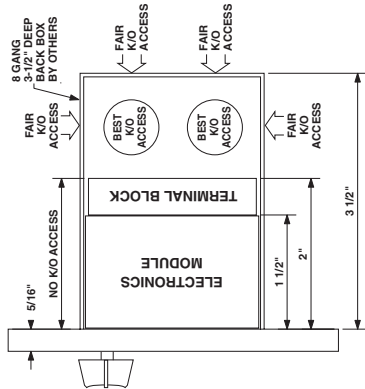

FRONT VIEW

SIDE VIEW

ANALOG CONTROL PANELS TO OTHER STATIONS OR TO 0-10V DIMMERS

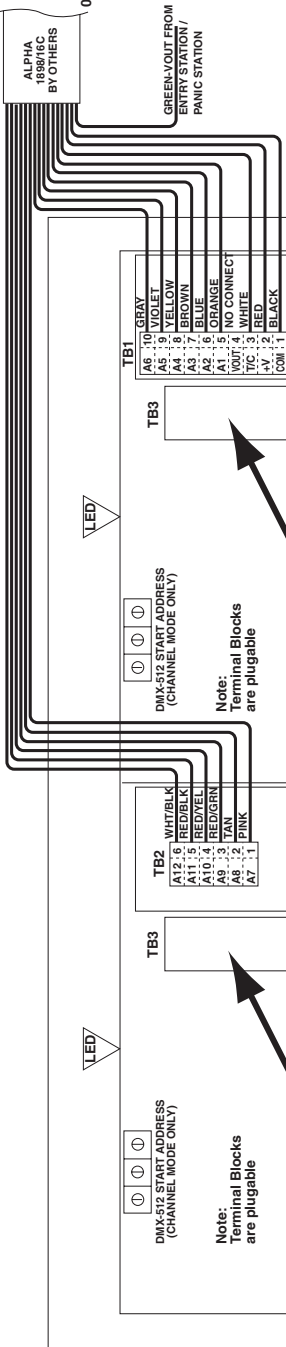

JUMPER SETTINGS	*DEFAULT SETTING
JP1	* OFF = SCENE SAVER MODE ON = CHANNEL MODE
JP2	* OFF = RECORD ENABLE (SS MODE ONLY) ON = RECORD LOCKOUT (SS MODE ONLY)
JP3	* OFF = STATION ALWAYS OUTPUTS DMX-512 ON = NO DMX OUTPUT WHEN STATION IS OFF
JP4	* OFF = CHANNEL MODE SINGLE SEQUENCE ON = CHANNEL MODE DUAL REPEAT SEQUENCE
JP5	* OFF = CHANNELS RILE ONTO DMX-512 IN ON = CHANNELS REPLACE DMX-512 IN L.V.L.S.
JP6	* OFF = 6 CHANNEL STATION ON = 4 CHANNEL STATION
JP7	RESERVED

LED DIAGNOSTIC FUNCTION	DIAGNOSTIC LED FUNCTION
BLINKING RED	= RECORD MODE
BLINKING YELLOW	= PLAY MODE WITH ACTIVE DMX-512 IN AND RECORD ENABLED
BLINKING GREEN	= PLAY MODE WITH ACTIVE DMX-512 IN OR RECORD DISABLED OR CHANNEL MODE
SOLID GREEN	= PLAY MODE WITH NO DMX IN AND RECORD ENABLED OR CHANNEL MODE
SOLID YELLOW	= PLAY MODE WITH NO DMX IN AND RECORD DISABLED

REAR VIEW

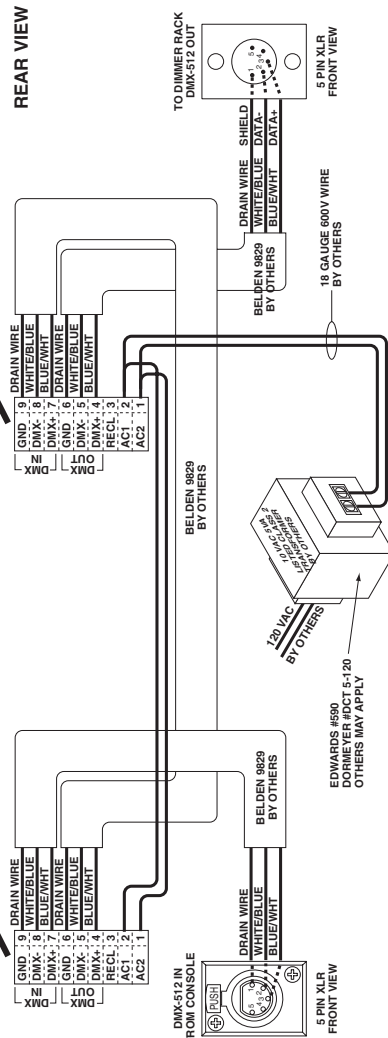

12 Channel DMX-512 Station (Cat. No. 019-RMB81-112)

**NSI Cat. No. N2408
1:1 DIMMER
TERMINATION**

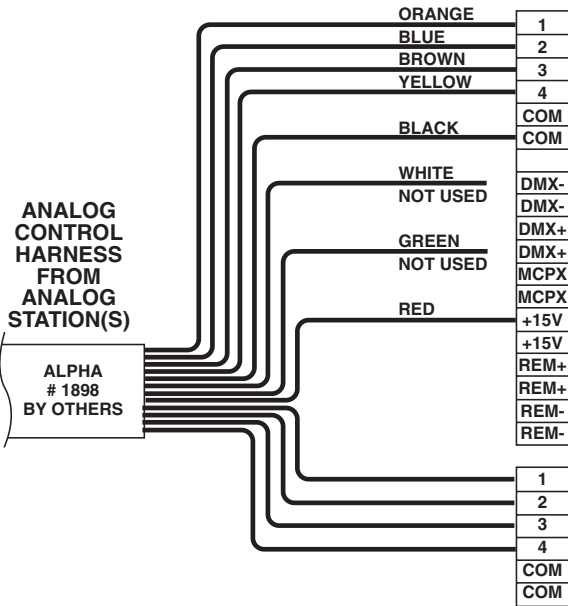

**Colortran Model ENR 12 OR 24 with
Universal Control Module # 166-902 (3)
1:1 (1-12) DIMMER TERMINATION**

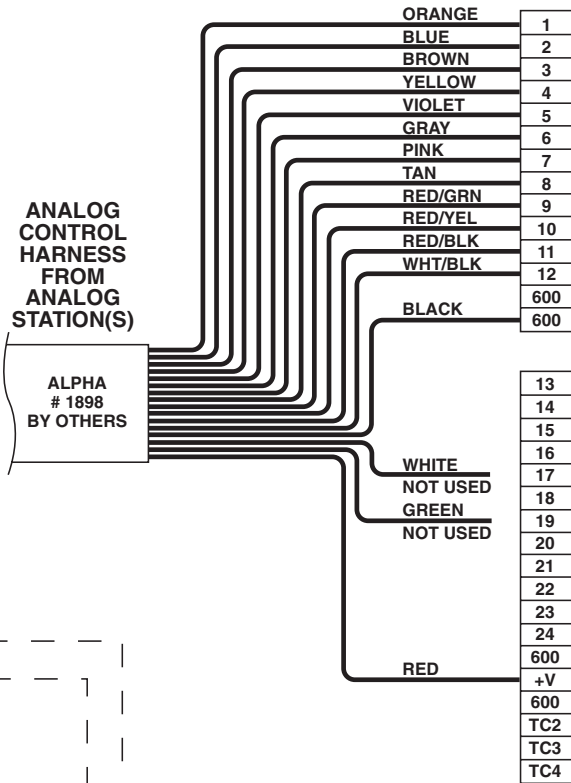

**Colortran Model ENR 96
8 Channel Houselight
DIMMER TERMINATION**

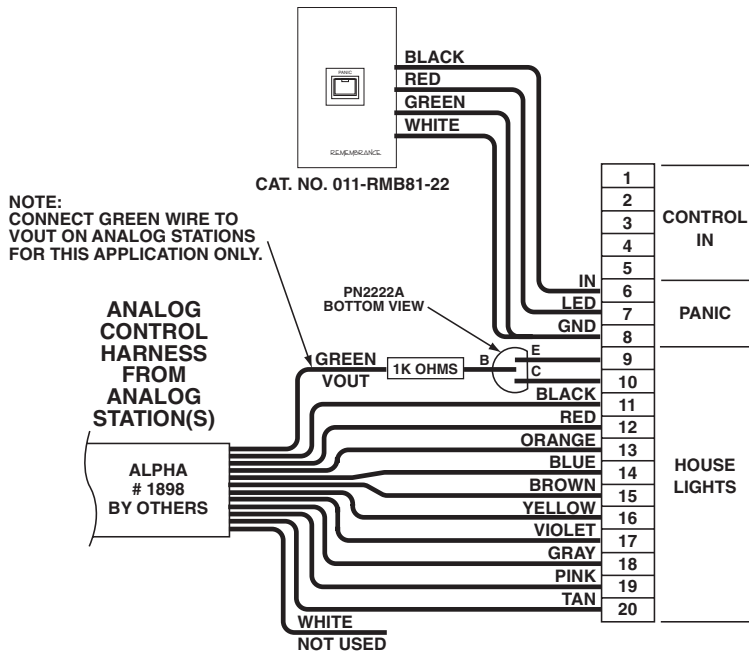

0-10V Analog Dimmer

WARRANTY

LIMITED TWO YEAR WARRANTY AND EXCLUSIONS

Leviton warrants to the original consumer purchaser and not for the benefit of anyone else that this product at the time of its sale by Leviton is free of defects in materials and workmanship under normal and proper use for two years from the purchase date. Leviton's only obligation is to correct such defects by repair or replacement, at its option, if within such two year period the product is returned prepaid, with proof of purchase date, and a description of the problem to **Leviton Manufacturing Co., Inc., Att: Service Department, 20497 SW Teton Ave., Tualatin, Oregon 97062**. All products returned to Leviton-NSI must have factory authorization for return prior to shipping. The purchaser is responsible for completing and mailing to Leviton, within 15 days of purchase, the warranty registration card enclosed with each product. This warranty excludes and there is disclaimed liability for labor for removal of this product or reinstallation. This warranty is void if this product is installed improperly or in an improper environment, overloaded, misused, opened, abused, or altered in any manner, or is not used under normal operating conditions or not in accordance with any labels or instructions. There are no other or implied warranties of any kind, including merchantability and fitness for a particular purpose, but if any implied warranty is required by the applicable jurisdiction, the duration of any such implied warranty, including merchantability and fitness for a particular purpose, is limited to two years. Leviton is not liable for incidental, indirect, special, or consequential damages, including without limitation, damage to, or loss of use of, any equipment, lost sales or profits or delay or failure to perform this warranty obligation. The remedies provided herein are the exclusive remedies under this warranty, whether based on contract, tort or otherwise.



Leviton NSI Division Headquarters
20497 SW Teton Avenue, Tualatin, OR 97062

Customer Service Telephone: 800.736.6682
Customer Service Fax: 503.404.5594
Technical Services: 800.959.6004

Leviton Manufacturing Company, Incorporated
59-25 Little Neck Parkway, Little Neck, NY 11362-2591

Visit Leviton's websites at <http://www.nsicorp.com> & <http://www.leviton.com>

Copyright© 2003. Leviton Manufacturing Company, Inc. All Rights Reserved
Specifications and pricing subject to change at any time.

PK-93382-00-01-1B