

INGENIA

IG4T

Quick start user manual
Section 1

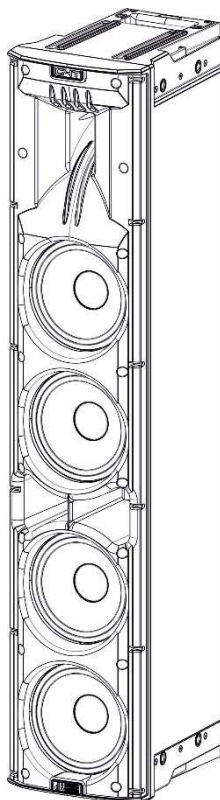

The warnings in this manual must be observed together with the "User Manual - Section 2".

Le avvertenze nel presente manuale devono essere osservate congiuntamente al "MANUALE D'USO - Sezione2".

Die Warnungen in diesem Handbuch müssen in Verbindung mit der "BEDIENUNGSANLEITUNG - Abschnitt 2" beobachtet werden".

Les avertissements spécifiés dans ce manuel doivent être respectés ainsi que les "CARACTERISTIQUES TECHNIQUES - Section 2".

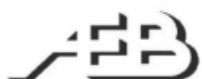

A.E.B. Industriale Srl Via Brodolini, 8 Località Crespellano 40053 VALSAMOGGIA BOLOGNA (ITALIA)
Tel +39 051 969870 Fax +39 051 969725 www.dbtechnologies.com info@dbtechnologies-aeb.com



Thank you for choosing a dBTechnologies Product!

INGENIA IG4T is a powerful 2-way vertical speaker, equipped with one 1.4" compression driver with a 3" voice coil and four 6.5" woofers, in an innovative shape. The horn of the driver is vertically asymmetrical, for a precise acoustical coverage in different kind of installations, indoor and outdoor. The powerful DIGIPRO® G3 amplifier section, capable of handling up to 900 W (RMS power), is controlled by a DSP, which can perform a detailed customization of the output sound of the speaker. In particular, the DSP can recognize if 2 INGENIA IG4Ts are installed together, stacked or flown, through the special IR communication handles, and can perform a digital steering, making them sound as one single source with a selectable inclination. All the DSP parameters can be viewed and selected in the user-friendly interface, equipped with a self-rotating OLED display, and can be saved and reloaded in different custom settings by the user, who can protect his choices with a password.

Check the site www.dbtechnologies.com for the complete user manual!

1) Unpacking

The box contains:

- N°1 INGENIA IG4T
- N°1 Mains cable with Neutrik® powerCON TRUE connector
- N°1 100-120 V FUSE
- This quick start and warranty documentation.

2) Easy Assembly

The speaker can be configured in 5 main modes:

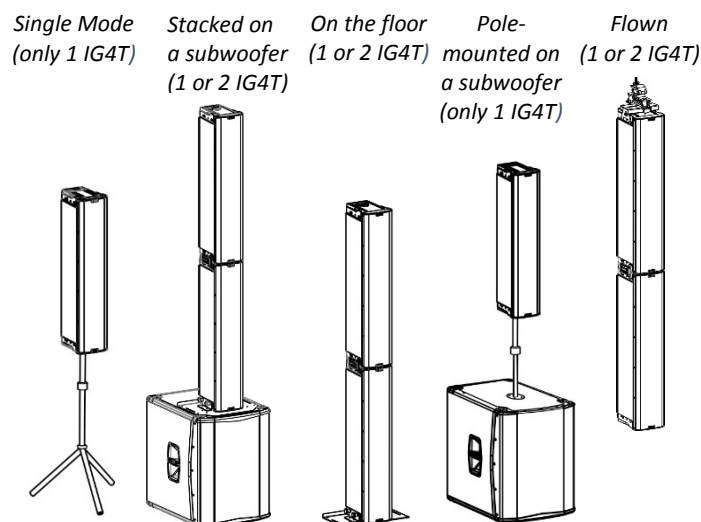

Option 1: Single Mode (1 speaker mounted on an optional pole stand)

The speaker is equipped with a standard pole-mounting hole, so it can be mounted on a D35 mm optional pole stand (tripod). For a safe installation, it is not admitted a 2-speakers mounting, and the user must check the stability of the system. The maximum admitted height is 120 cm (47.25 inch.).

Option 2: Stacked on a subwoofer (1 or 2 speakers)

The speaker can be mounted on a subwoofer with D35 pole mounting hole, using a GSA-IG optional adapter. It is mandatory to use an additional fastening system.

Option 3: On the floor (1 or 2 speakers)

The speaker can be mounted on the floor, only using a GSA-IG optional adapter. In this case it is mandatory to use an additional fastening system or straps.

Option 4: Pole-mounted on a subwoofer (1 speaker)

Only one speaker can be installed on a D35 pole,

(maximum height: 120 cm – 47.25 in.), mounted on a subwoofer. It is mandatory to use an additional fastening system to secure properly the installation.

Option 5: Flown (1 or 2 speakers)

The speaker can be mounted flown, using the optional DRK-IG fly bar and TGA-IG truss adapter.

In a 2-speakers configuration, it is mandatory to use a couple of LP-IG optional link brackets to mount them together. / Other kinds of installation not illustrated in this manual are not admitted. / Don't cover the handles in any way, they are equipped with infrared ports!

3) Connections and Oled Display

The INGENIA speakers are equipped with an intuitive OLED display. All the connections are in the amplifier panel side:

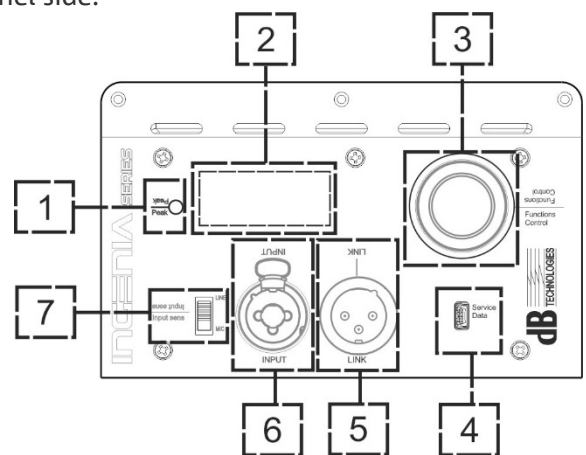

- 1 – Peak led.
- 2 – OLED Display.
- 3 – Push rotary encoder (rotate: select, push: confirm).
- 4 – Mini B-type USB port (for firmware updating).
- 5 – Link audio output.
- 6 – Combo line/mic input.
- 7 – Input sense switch (LINE/MIC).

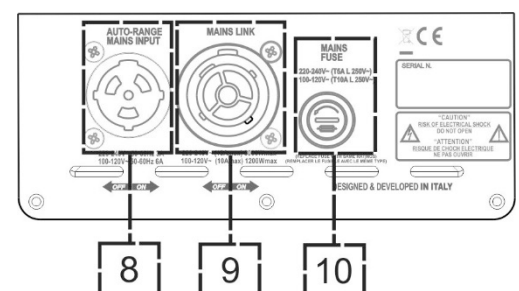

- 8 – Auto-range mains (power) input.
- 9 – Mains (power) link output.
- 10 – Mains fuse.

The fuse is factory setted for 220-240 V operation.

If it is necessary to change the fuse to 100-120V range:

1. Disconnect the speaker from any cable
2. Wait 5 minutes
3. Substitute the fuse with the correct one supplied

Use only cables with Neutrik® connectors!

4) Ready in less than a minute – Build System menu

The internal DSP provides an easy setup of installation and allows to configure quickly the IG4T. Even if you turn off the speaker, your setting will be saved for the next session!

Set up instructions

Once you have properly connected the power supply and audio input (remember to select the proper "LINE"/"MIC" choice in input sense switch (7)), select the gain level in the first display window, rotating the push rotary encoder, then push it to access the menu choice wizard.

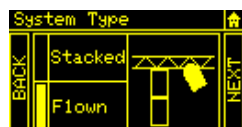
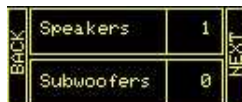
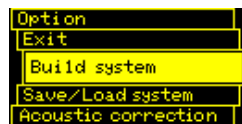

1. Select and confirm "Build System".
2. Select and confirm the "Selfcheck System" to launch the automatic recognition procedure and select and confirm "NEXT".
3. In the next "System Structure" menu you can find the number of "Speakers" automatically recognized, and you can choose and confirm the number of "Subwoofers" you want to use in your configuration. Then select and confirm "NEXT".
4. In "System Type" you can specify the "Stacked" (on the floor - pole mounting - subwoofer mounting) or "Flown" (fly-bar mounting) type of installation. Then select and confirm "NEXT".

Holding the rotary encoder, you return to the main Gain/Level window, from each submenu window.

If the system has automatically recognized the presence of 2 speakers, the next menu will be "System coverage". If you have selected the presence of a subwoofer in your installation, the next menu will be the "Subwoofer Matching" menu.

5) System Coverage

The INGENIA IG4T's powerful DSP can act as a custom delay line on the transducers, in order to direct the

final acoustical coverage of the speaker. This menu will appear only when the DSP has recognized 2 IG4Ts thanks to the infrared handles.

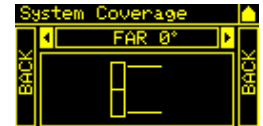

You can choose up to 7 factory settings:

- a. UP +10°, for the maximum inclination angle (with speakers mounted on the floor, on a stand or a subwoofer)
- b. UP +5°, for a medium inclination angle (with speakers mounted on a floor, on a stand or a subwoofer)
- c. UP +2.5°, for a low inclination angle (with speakers mounted on the floor, on a stand or a subwoofer)
- d. FAR 0°, for the maximum distance coverage in a position directly at the level of the audience
- e. DOWN -2.5°, for a long-distance coverage (flown speakers)
- f. DOWN -5°, for a medium-distance coverage (flown speakers)
- g. DOWN -10°, for a short-distance coverage (flown speakers)

6) Subwoofer Matching

Once you have chosen to match the system to one or more subwoofers, a menu will appear allowing you to select: the model and the HP Filter frequency, and the system will suggest you the correct subwoofer delay.

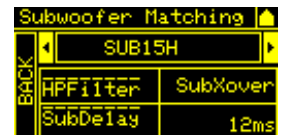

7) System Delay

You can set a custom delay on your speakers in milliseconds, meters or feet, in order to align your speakers with the main sound system (see the picture below).

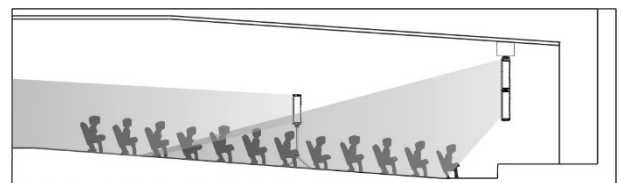

8) Stage Alignment

When you are on stage and you have different acoustic sources (for example the drums of a band) you can choose to align your speaker with those sources. In this menu you can set the distance in meters or feet, or the time in ms.



SUPERUSER PASSWORD

You can set a Password in OPTIONS → PASSWORD in order to protect your custom settings. If you forget the password, use the code: **Q2R5D9** to unlock the system.

Technical Data

Speaker Type: 2-way Active Speaker

Acoustical data

Frequency Response [-10dB]: 74 - 20.000 Hz

Frequency Response [-6dB]: 88 - 19.200 Hz

Max SPL: 132 dB

HF compression driver: 1.4" Exit

HF voice coil: 3" Titanium

Horn Coverage (HxV): 110 x 90° (+20°/-70°)

Directivity: Vertical asymmetric

HF type: Neodymium compression driver

Crossover frequency: 1100 Hz

LF: 4x6.5"

LF Voice Coil: 1.5"

LF Type: Neodymium

Amplifier

Amp Technology: Digipro® G3

Amp Class: Class-D

RMS Power: 900 W

Peak Power: 1800 W

Self-rotating display: yes

Positioning: EPD (Element Position Detection)

Display mirroring: Yes

User Interface: OLED display + push rotary encode

Processor

Controller: DSP 56 bit

AD/DA Converter: 24 bit / 48 kHz

Limiters: Dual Active, Peak, RMS, Thermal

Input

Signal Input: 1x Combo IN (XLR/Jack)

Signal Out: 1 XLR link OUT

USB connector: Yes - mini USB

Mechanics

Housing: Polypropylene PP reinforced by internal metal structure

Grille: FULL / Invisible screws

Flyable: Yes

Handles: 1x on TOP / 1x on BOTTOM

Pole Mount: Yes, 36 mm

Width: 195 mm (7.68 in)

Height: 956 mm (37.64 in)

Depth: 271 mm (10.67 in)

Weight: 18.2 kg - 40 lbs



Scan with your QR Reader
App to download the
complete User Manual

Download the complete user manual on:
www.dbtechnologies.com/EN/Downloads.aspx

EMI CLASSIFICATION

According to the standards EN 55103 this equipment is designed and suitable to operate in E3 (or lower E2, E1) Electromagnetic environments.

FCC CLASS B STATEMENT ACCORDING TO TITLE 47, PART 15, SUBPART B, §15.105

This equipment has been tested and found to comply with the limits for a Class B digital device, pursuant to part 15 of the FCC Rules.

These limits are designed to provide reasonable protection against harmful interference in a residential installation.

This equipment generates, uses and can radiate radio frequency energy and, if not installed and used in accordance with the instructions, may cause harmful interference to radio communications.

However, there is no guarantee that interference will not occur in a particular installation. If this equipment does cause harmful interference to radio or television reception, which can be determined by turning the equipment off and on, the user is encouraged to try to correct the interference by one or more of the following measures:

1. Reorient or relocate the receiving antenna.
2. Increase the separation between the equipment and receiver.
3. Connect the equipment into an outlet on a circuit different from that to which the receiver is connected.
4. Consult the dealer or an experienced radio/TV technician for help.

WARNING: Make sure that the loudspeaker is securely installed in a stable position to avoid any injuries or damages to persons or properties. For safety reasons do not place one loudspeaker on top of another without proper fastening systems. Before hanging the loudspeaker check all the components for damages, deformations, missing or damaged parts that may compromise safety during installation. If you use the loudspeakers outdoor avoid spots exposed to bad weather conditions.

Contact dB Technologies for accessories to be used with speakers. dBTechnologies will not accept any responsibility for damages caused by inappropriate accessories or additional devices.

Features, specification and appearance of products are subject to change without notice.

dBTechnologies reserves the right to make changes or improvements in design or manufacturing without assuming any obligation to change or improve products previously manufactured.