

SCM125 product information sheet



The SCM125 is a sturdy single TV ceiling mount, with universal adapter, that's ideal for any ceiling application – whether TV viewing or digital signage. Our professional-grade ceiling mounts provide single or back-to-back mounting options.

Product Benefits*

- Portrait or landscape orientation
- Includes universal adapter for greater VESA compatibility
- Tension adjustment for variable tilt or locking pin mechanism for precise positioning
- Integrated cable management routes cables through NPT pipe and ceiling plate
- Lift n' Lock™ for quick installation
- Includes 24" of 1.5" NPT
- Threaded bottom pipe for additional accessories
- Includes ceiling plate
- Includes Grade 5 hardware kit
- NPT extension pipes available in 12", 18" and 24" lengths

Product Specifications*

Fits most: 32–65" TVs
Supports up to: 125 lbs (56.7 kg)
Tilt: Up to +25°
VESA compliance: 200x100 to 600x400
Warranty: 5 years
Color: Black



Series



SCM125



DCM250



The SCM125 is equipped with a pin tilt mechanism which tilts the TV at precise increments making it well-suited for single or multiple TV installations.

*Subject to change

800.MOUNT.IT (800.668.6848)



OMNI MOUNT

04032014

SCM125 technical data sheet

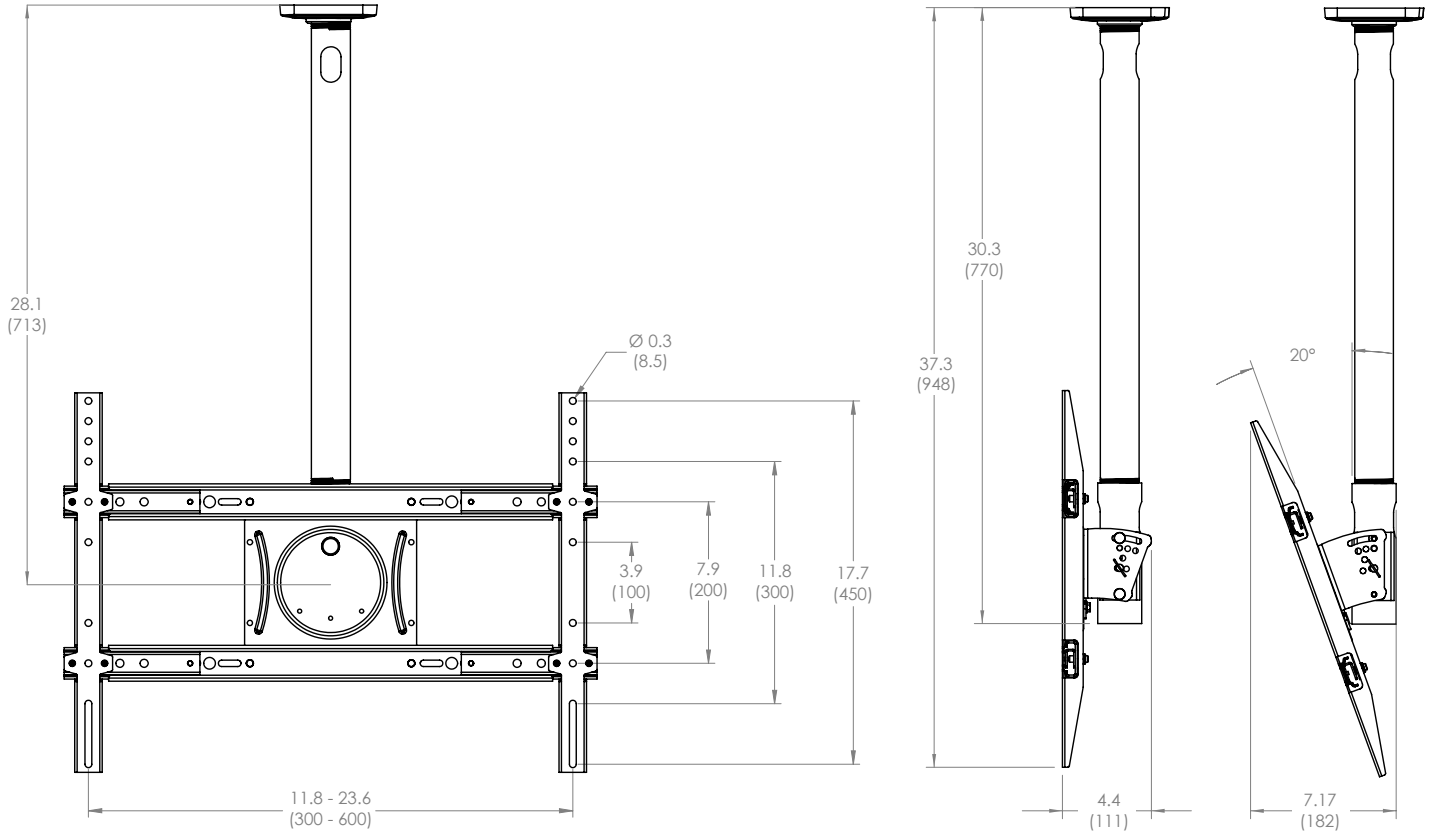

inches (mm)

	Packaging UPC	MC UPC
Americas	698833022933	NA
International	698833022933	NA

	Dimensions WxDxH Inches (mm)	Wt lbs (kg)	Qty
Box	24.4 x 20.9 x 3.9 (620x532x98)	24 (10.9)	NA
MC	NA	NA	NA

Box Contents	Qty
Ceiling plate	1
NPT pipe	1
Tilt hanger	1
Universal adapter	1
VESA plate	1

Box Contents	Qty
Monitor kit	1
Ceiling kit	1
Instruction manual	1
Complete hardware kit	1