



# User Manual

DV-HSW4K-41

HDMI 4x1 Switcher

Based on firmware 01.09











244 Bergen Boulevard, Woodland Park, NJ 07424 • Tel 973-785-4347 •  
FAX 973-785-3318 • Web: [www.fsrinc.com](http://www.fsrinc.com)

# Important Safety Instructions

Contents are subject to change without notice

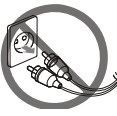
## Warnings

To reduce the risk of fire, electric shock or product damage:

- |   |  |   |  |
|---|--|---|--|
|    | <p><b>1.</b> Do not expose this device to rain, moisture, dripping or splashing and that no objects filled with liquids, such as vases, shall be placed on the unit.</p>                         |    | <p><b>6.</b> Clean this device only with dry cloth.</p>  |
|    | <p><b>2.</b> Do not install or place this unit in a bookcase, built-in cabinet or in another confined space. Ensure the unit is well ventilated.</p>   |    | <p><b>7.</b> Unplug this device during lightning storms or when unused for long periods of time.</p> |
|    | <p><b>3.</b> To prevent risk of electric shock or fire hazard due to overheating, do not obstruct the unit's ventilation openings with newspapers, tablecloths, curtains, and similar items.</p> |    | <p><b>8.</b> Protect cables and cords from being walked on or pinched particularly at plugs.</p>     |
|   | <p><b>4.</b> Do not install near any heat sources such as radiators, heat registers, stoves, or other device (including amplifiers) that produce heat.</p>                                       |   | <p><b>9.</b> Only use attachments/accessories specified by FSR.</p>                                  |
|  | <p><b>5.</b> Do not place sources of open flames, such as lighted candles, on the unit.</p>  |  | <p><b>10.</b> Refer all servicing to qualified service personnel.</p>                                |

# Table of Contents

Important Safety Instructions .....	2
Overview .....	4
Features .....	4
Package Contents .....	5
Typical Application .....	5
Dimensions .....	6
DV-HSW4K-41 Front Panel .....	7
DV-HSW4K-41 Rear Panel .....	8
Hardware Installation .....	9
EDID Management .....	10
RS-232 Operation .....	11
RS-232 Serial Protocol .....	11
Request/Response Format .....	11
Field Separators .....	12
Command Request Syntax: .....	12
Acknowledging Receipt of Commands .....	13
Error Response .....	13
REQUEST LIST QUICK REFERENCE .....	13
Connection Request .....	14
Disconnect Request .....	14
HDCP Request .....	15
Model Request .....	16
Reconnect Request .....	16
Status Request .....	17
Version Request .....	18
Specifications .....	19
Limited Warranty .....	20

# Overview

The DV-HSW4K-41 is a 4 by 1 4K HDMI switcher, a perfect solution for managing multiple sources. It provides four inputs for direct connection of HDMI devices, which gives you a high performance connection between four sources and a display without signal loss.

Simply pressing one button to selects the desired HDMI source for display on the HDTV. The front panel indicators show the currently selected source.

It can be widely used in digital entertainment centers, control centers, conference rooms, schools and corporate training environments.

The DV-HSW4K-41 is also an integral part of FSR's HuddleVU Collaboration Systems

# Features

- Easy installation
- Resolutions up to 4K@30Hz
- Both input/output port support HDMI cable up to 10m
- Four push buttons to select the input source
- HDMI 1.4 with 4K
- HDCP compliant
- EDID management
- 12V DC Power Supply with locking connector included

# Package Contents

- 1 x HDMI Switcher DV-HSW4K-41
- 1 x 12VDC Power Supply
- 2 x Mounting Ears
- 1 x 3.81mm Phoenix Connector (3 Pin)

# Typical Application

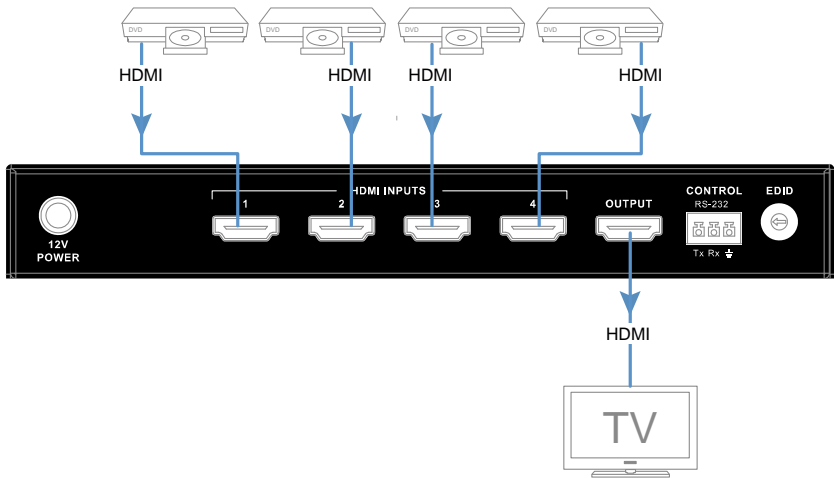

# Dimensions

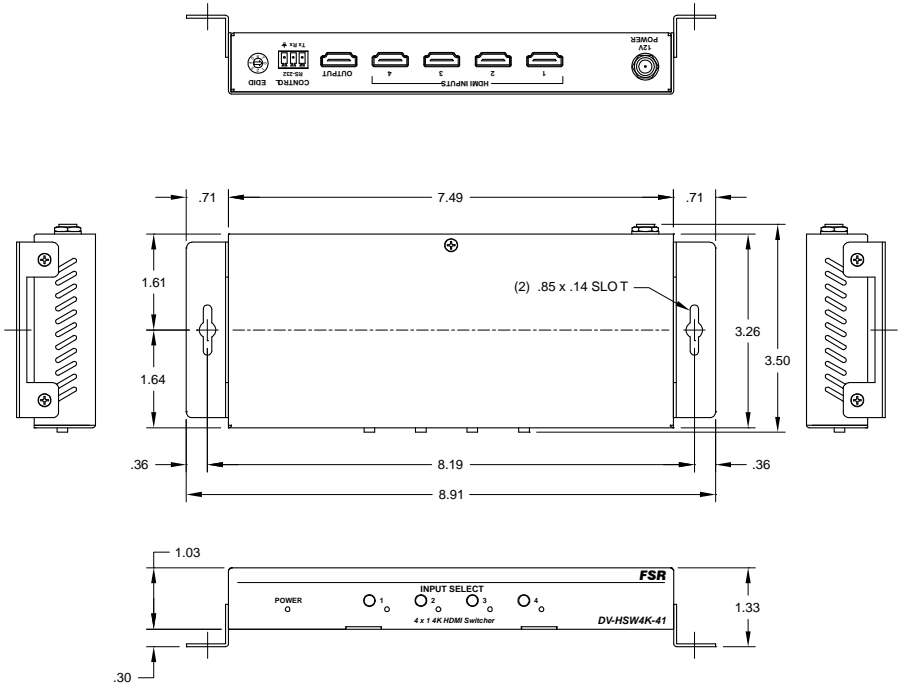

# DV-HSW4K-41 Front Panel

## Front Panel

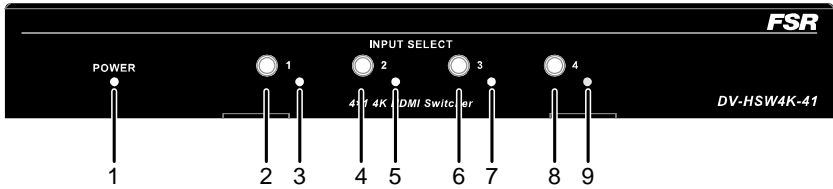

ID	Name	Description
1	Power LED	Lit when power is on
2	Select Button	Press to select HDMI IN 1 as input source
3	Indicator	Lit when HDMI IN 1 is selected
4	Select Button	Press to select HDMI IN 2 as input source
5	Indicator	Lit when HDMI IN 2 is selected
6	Select Button	Press to select HDMI IN 3 as input source
7	Indicator	Lit when HDMI IN 3 is selected
8	Select Button	Press to select HDMI IN 4 as input source
9	Indicator	Lit when HDMI IN 4 is selected

# DV-HSW4K-41 Rear Panel

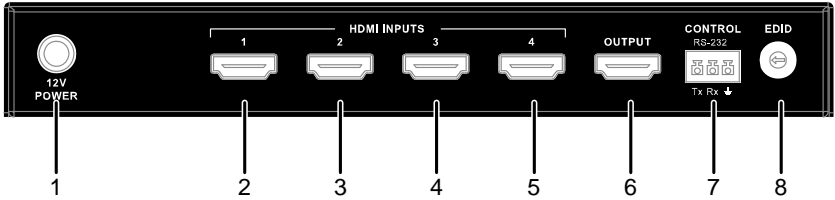

ID	Name	Description
1	Power	12V 1A DC power input
2	HDMI IN 1	Connects to an HDMI source
3	HDMI IN 2	Connects to an HDMI source
4	HDMI IN 3	Connects to an HDMI source
5	HDMI IN 4	Connects to an HDMI source
6	HDMI OUT	Connects to an HDMI display
7	RS232	<p>RS232 control.</p> <div style="border: 1px solid gray; padding: 5px; width: fit-content;"> <p>BaudR <input type="text" value="38400"/></p> <p>DParity <input type="text" value="NONE"/></p> <p>DataB <input type="text" value="8"/></p> <p>StopB <input type="text" value="1"/></p> </div> <p>For API commands, please refer to DV-HSW4K-41 RS-232 Serial Protocol</p>
8	EDID DIP Switch	Adjust EDID settings



# Hardware Installation

1. Connect the HDMI input sources (such as Blu-Ray, game console, media server etc.) to the input ports of the HDMI switcher using quality HDMI cables.

Power off all equipment when connecting /extracting cables.

2. Connect the HDMI display (LED/LCD display or projector) to the HDMI output port of the HDMI switcher.
3. Connect the power supply to the HDMI switcher and power on all the devices.
4. To operate DV-HSW4K-41, use the front panel select button or remote control handset.

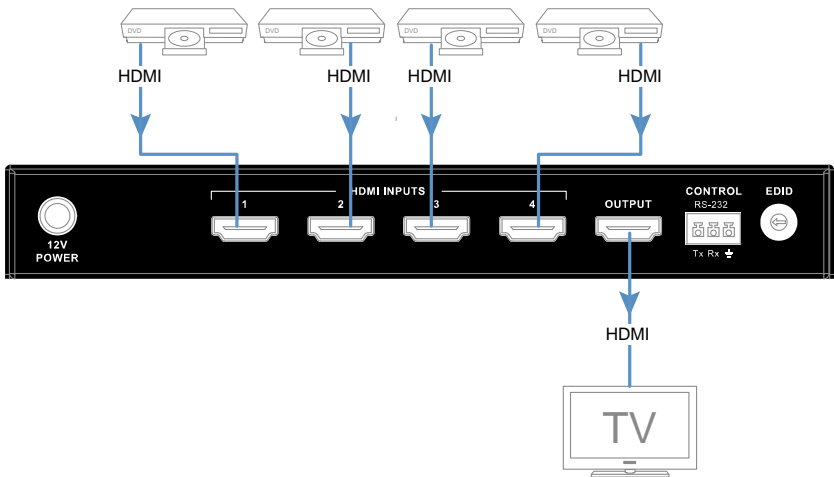

# EDID Management

The HDMI Switcher features an EDID copy mode that can be used when the EDID's do not meet the installation requirements.

**Note:** The change doesn't take effect until you restart the HDMI Switcher.

Position	Functions
0	Automatically copy HDMI display's EDID to all HDMI Inputs, if failed, the EDID of all HDMI inputs won't change.
1	4K2K 30Hz 2CH (Default)
2	1280 x 800 60Hz 2CH
3	1920 x 1080 60Hz 2CH
4	1920 x 1200 60Hz 2CH
5	1280 x 720 60Hz 2CH
6	1024 x 768 60Hz 2CH
7	800 x 600 60Hz 2CH

# RS-232 Operation

The DV-HSW4K-41 switcher may be configured or queried via the RS232 serial connection.

Baud Rate: 38,400bps

Data bits: 8

Stop bits: 1

Parity: None

Flow control: None

Computer (DTE)		DV-HSW4K-41
Pin 2 Rx	←	Tx
Pin 3 Tx	→	Rx
Pin 5 Ground	—	Ground

## RS-232 Serial Protocol

The DV-HSW4K-41 switcher may be configured or queried via the RS-232 serial connection.

## Request/Response Format

All requests and responses will be entirely in ASCII. The requests can be in either upper or lower case.

All requests will have three character command field followed by the data required for that specific request. All requests are terminated with a carriage return (0Dh), which will be referred to in this document as `<cr>`. All responses are terminated with a carriage return `<cr>` and a line feed (0Ah) which will be referred as `<lf>`.

# Field Separators

Fields are separated by *white* space, that is any number of spaces or tabs as long as the entire command is less than 80 characters. A *<cr>* terminates the command. Below is an example describing a command.

<b>CON</b>	<i>num</i>	<i>&lt;cr&gt;</i>
------------	------------	-------------------

So the actual message would look like this:

CON 2<cr>

## Command Request Syntax:

This document uses the following notation when describing the syntax of a command request:

**BOLD** – identifies the command

lower case – identifies data to be entered which is described in the text following the syntax description

" " - entry defined within double quotes is to be entered exactly as shown

< > - entry defined within these brackets is required

[ ] - entry defined within these brackets is optional

{ } - entry defined within curly brackets must be entered at least once

| - a vertical bar denotes a logical choice of entry

\* - an asterisk following either [ ] brackets or curly brackets { } above denotes that data within either brackets or curly brackets may be entered multiple times.

# Acknowledging Receipt of Commands

Each request sent to the DV-HSW4K-41 switcher will have by default two possible responses, an acknowledgement of a correct request or an error response. The acknowledge response will be:

```
Ok<cr><lf>
```

## Error Response

It is inevitable that errors occur in the requests sent to the DV-HSW4K-41 switcher. If an invalid *command* is sent to the DV-HSW4K-41 switcher, the DV-HSW4K-41 switcher will respond with the message "**ERR: unknown command**". If an invalid parameter is sent to the DV-HSW4K-41 switcher, the DV-HSW4K-41 switcher will respond with the message "**ERR:**" followed by the valid syntax for the errored entry.

---

**Example:**

A connect request with an incorrect input number:

```
CON 5<cr>
```

The error response would be:

```
ERR: CON 5<cr>
```

## REQUEST LIST QUICK REFERENCE

REQUEST	DESCRIPTION
CON	Connection Request
DIS	Disconnect Request
HDCP	High Definition Content Protection Status Request
MOD	Model Request
REC	Reconnect Request
STA	Status Request
VER	Request Version Number

# Connection Request

The connection request is used to connect one of the four available inputs to the output. A connection may be disconnected by using the **DIS** command (see later in document).

<b>CON</b>	<i>input</i>   "?"	<cr>
------------	--------------------	------

**Syntax:**

CON <input | "?"><cr>

Where:

- CON** Connection request header
- input Input number in the range 1-4
- "?" Request to return the currently selected input (the front panel LEDs reflect the currently selected input).

**(Note: A CON *input* command will override the disconnected output, ie via the DIS command. See below for description of DIS command.)**

**Example:**

To connect input 2 to output, the connection request would look like this:

`CON 2<cr>`

---

To request the currently connected input, the connection request would look like this: `CON ?<cr>`

---

The response from the DV-HSW4K-41 switcher would be:

`CON 2<cr><lf>`

If a previously connected input were subsequently disconnected via the DIS command, then the CON ? command will return the currently selected input.

---

# Disconnect Request

The disconnect request is used to disconnect (disable) the output of the switcher.

<b>DIS</b>	<code>&lt;cr&gt;</code>
------------	-------------------------

**Syntax:** DIS<cr>

Where:

**DIS** Disconnect request header

**Example:**

To disconnect (disable) the output of the switcher, the user would send the following message:

`DIS<cr>`

## HDCP Request

The High-bandwidth Definition Content Protection status request allows identification of the presence of HDCP on each of the available inputs. The format for the HDCP request is as follows:

<b>HDCP</b>	<code>&lt;cr&gt;</code>
-------------	-------------------------

**Syntax:** HDCP<cr>

Where:

**HDCP** High Definition Content Protection request header

**Response:** HDCP *xxxx*

Where:

*x* is either 0 or 1, with 0 representing that HDCP is not present and 1 representing that HDCP is present.

**Example:**

To query the HDCP status of the unit the user would send the following message: `HDCP<cr>`

The response for the DV-HSW4K-41 switcher could be:

`HDCP 0111<cr><lf>`

That is, HDCP is not present on input 1 and HDCP is present on inputs 2-4.

# Model Request

The MOD Model request allows identification of the model number of the DV-HSW4K-41 switcher. The unit will return the current model identification, ie DV-HSW4K-41. The format for the model request is as follows:

MOD	<cr>
-----	------

**Syntax:** MOD<cr>

Where:

**MOD** Model request header

**Response:** MOD *model\_number*

Where:

*model\_number* is DV-HSW4K-41 for this product.

**Example:**

To query the model number of the unit the user would send the following message: MOD<cr>

The response for the DV-HSW4K-41 switcher would be:

MOD DV-HSW4K-41<cr><lf>

# Reconnect Request

The REC request allows the user to reconnect the disconnected output to the currently selected input. Note that the input to be reconnected is as indicated by the input LED on the front panel. The command has no effect if an input is already connected to the output.

REC	<cr>
-----	------

**Syntax:** REC<cr>

Where:

**REC** Reconnect request header



**Example:**

To reconnect the previously connected input 2 to output, the user would send the following message:

`REC<cr>`

## Status Request

The STA request returns the presence of signal on the respective inputs, 1 = signal present, 0 = no signal present.

STA	<cr>
-----	------

**Syntax:** STA<cr>

Where:

**STA**                      Status request header

**Example:**

To query for the presence of signal on inputs 1-4 the user would send the following message:

`STA<cr>`

If signal were present on input 1 and input 3, but not present on input 2 and input 4, then the response from the DV-HSW4K-41 switcher would be:

`STA 1010<cr><lf>`

If signal were not present on input 1 and input 3, but present on input 2 and input 4, then the response from the DV-HSW4K-41 switcher would be:

`STA 0101<cr><lf>`

# Version Request

In order to be able to identify the current firmware version populated in the unit, the user may request using the VER request. The format for the request will be as follows:

<b>VER</b>	<code>&lt;cr&gt;</code>
------------	-------------------------

**Syntax:** VER<cr>

Where:

**VER**          Version Request header

**Response:** VER DV-HSW4K-41 <XX.xx>

Where:

XX.xx          XX = Major version number, xx = Minor version number

**Example:**

`VER<cr>`

To which the DV-HSW4K-41 switcher will respond:

`VER DV-HSW4K-41 01.09<cr>`

# Specifications

<b>Video</b>	
Input	4 x HDMI
Output	1 x HDMI
Input/ output Signal Type	HDMI: HDMI 1.4 with HDCP
Input/output Resolution Support	HDMI: 480i,576i,480p,576p,720p@50, 720p@60,1080p@24,1080i@25, 1080i@30,1080p@30,1080p@50, 1080p@60, 4K x 2K@30
Maximum Pixel Clock	297 MHz
Input Video Signal	0.5~1.5 volts p-p
Video Impedance	100 ohms
<b>General</b>	
Power Supply	12V 0.5A DC
Power Consumption	4.1 Watts Max
Control Method	Front Panel Buttons, RS232 control
Operating Temperature	32°F to 113°F (0°C to 45°C) 10% to 90%, non-condensing
Storage Temperature	-4°F to 140°F (-20°C to 70°C) 10% to 90%, non-condensing
ESD Protection	Human-body Model: ± 4kV(Contact discharge)
<b>General</b>	
Dimensions (L x W x H)	7.51" x 3.50" x 1.03" (191mm x 89mm x 26.1mm)
Weight	1.00 lb (0.45kg.)

# Limited Warranty

The DV-HSW4K-41 is warranted against failures due to defective parts or faulty workmanship for a period of three years after delivery to the original owner. During this period, FSR will make any necessary repairs or replace the unit without charge for parts or labor. Shipping charges to the factory or repair station must be prepaid by the owner, return-shipping charges (via UPS Ground) will be paid by FSR.

This warranty applies only to the original owner and is not transferable. In addition, it does not apply to repairs done by other than the FSR factory or Authorized Repair Stations.

This warranty shall be cancelable by FSR at its sole discretion if the unit has been subjected to physical abuse or has been modified in any way without written authorization from FSR. FSR's liability under this warranty is limited to repair or replacement of the defective unit.

FSR will not be responsible for incidental or consequential damages resulting from the use or misuse of its products. Some states do not allow the exclusion of incidental or consequential damages, so the above limitations may not apply to you. This warranty gives you specific legal rights, and you may also have other rights which vary from state to state.

Warranty claims should be accompanied by a copy of the original purchase invoice showing the purchase date (if a Warranty Registration Card was mailed in at the time of purchase, this is not necessary). Before returning any equipment for repair, please read the important information on service below.

## SERVICE

Before returning any equipment for repair, please be sure that it is adequately packed and cushioned against damage in shipment, and that it is insured. We suggest that you save the original packaging and use it to ship the product for servicing. Also, please enclose a note giving your name, address, phone number and a description of the problem.

NOTE: all equipment being returned for repair must have a Return authorization (RMA) Number. To get a RMA Number, please call the FSR Service Department (1-800-332-FSR1).

Please display your RMA Number prominently on the front of all packages.

## CONTACT INFORMATION:

FSR INC.

244 Bergen Blvd.

Woodland Park, NJ 07424

Phone: (973) 785-4347

Order Desk Fax: (973) 785-4207

**Web Site:** <http://www.fsrinc.com>