



by Schneider Electric

Installation Guide Smart-UPS™

750/1000/1500/2200/3000 VA 100/120/230 Vac

Rack-Mount 2U

Important Safety Messages

Read the instructions carefully to become familiar with the equipment before trying to install, operate, service or maintain it. The following special messages may appear throughout this manual or on the equipment to warn of potential hazards or to call attention to information that clarifies or simplifies a procedure.



The addition of this symbol to a Caution product safety label indicates that an electrical hazard exists which will result in personal injury if the instructions are not followed.

The following safety messages may appear throughout this manual to warn of potential hazards.

CAUTION

CAUTION indicates a potentially hazardous situation which, if not avoided, **can result in** equipment damage and minor or moderate injury.

CAUTION

CAUTION indicates a potentially hazardous situation which, if not avoided, **can result in** equipment damage.

Safety and General Information

Inspect the package contents upon receipt. Notify the carrier and dealer if there is any damage.

Read the Safety Guide supplied with this unit before installing the UPS.

- Adhere to all national and local electrical codes.
- This UPS is intended for indoor use only.
- Do not operate this UPS in direct sunlight, in contact with fluids, or where there is excessive dust or humidity.
- Be sure the air vents on the UPS are not blocked. Allow adequate space for proper ventilation.
- The battery typically lasts for two to five years. Environmental factors impact battery life. Elevated ambient temperatures, poor quality utility power, and frequent short duration discharges will shorten battery life.
- Connect the UPS power cable directly to a wall outlet. Do not use surge protectors or extension cords.
- The equipment is heavy. Always practice safe lifting techniques adequate for the weight of the equipment.
- The batteries are heavy. Remove the batteries before installing the UPS and XLBP in a rack.
- Always install external battery packs (XLBPs) at the bottom in rack-mount or stack configurations. The UPS must be installed above the XLBPs.
- Always install peripheral equipment above the UPS in rack-mount or stack configurations.
- The UPS will recognize as many as 10 external battery packs connected to the UPS. However there is no limit to the number of XLBPs that can be used with the UPS.
- The model and serial numbers are located on a small, rear panel label. For some models, an additional label is located on the chassis under the front bezel.
- Always recycle used batteries.
- Recycle the package materials or save them for reuse.

Inventory

All models



(1)

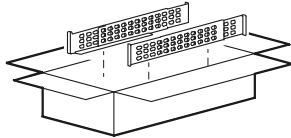

(1)

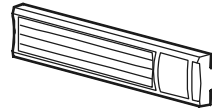

(1)

2200/3000 VA models

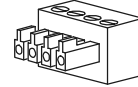

(1)

120/208/230 Vac models



(1)

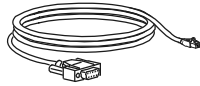

(1)

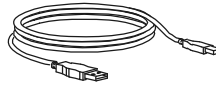

(1)

230 Vac models

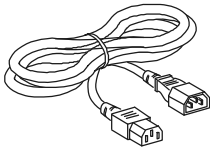

(2)

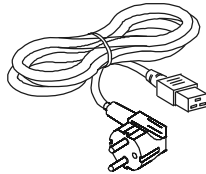

(1)

2200/3000 VA models

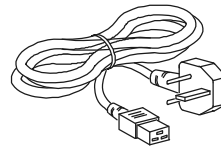

(1)

2200/3000 VA models

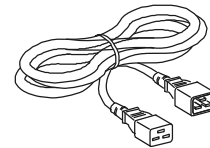

(1)

2200/3000 VA models

Installation

⚠ CAUTION

DAMAGE TO EQUIPMENT OR PERSONNEL

- The equipment is heavy. Always practice safe lifting techniques adequate for the weight of the equipment.
- Remove the battery before installing the UPS in a rack.
- When installing equipment in a rack, always install the UPS at the bottom of the rack with the peripheral equipment above the UPS.
- The UPS should always be installed below peripheral equipment in stack or rack configurations.

Failure to follow these instructions can result in equipment damage and minor or moderate injury

750 VA models

1

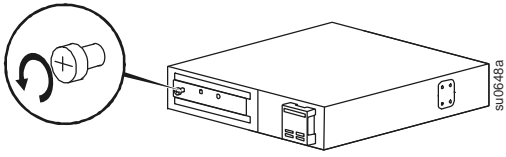

2

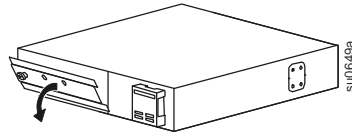

3

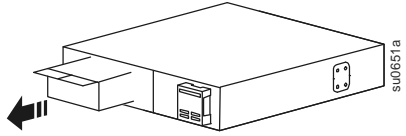

4

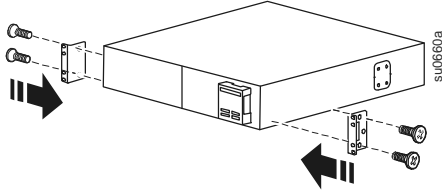

5

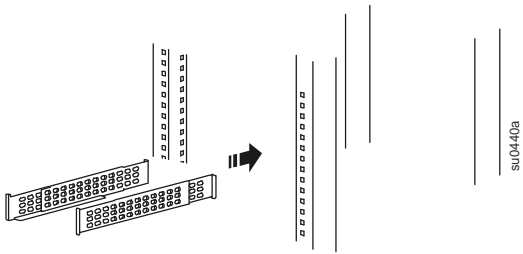

6

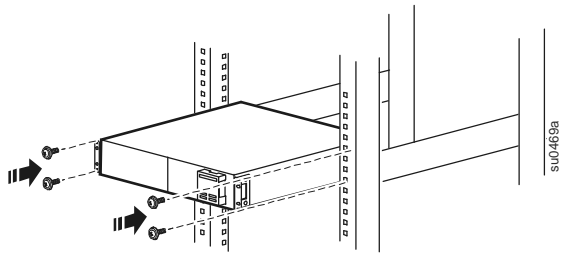

7

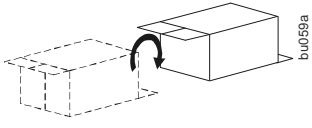

8

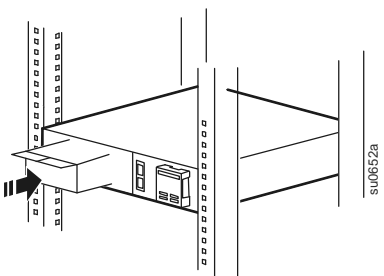

9

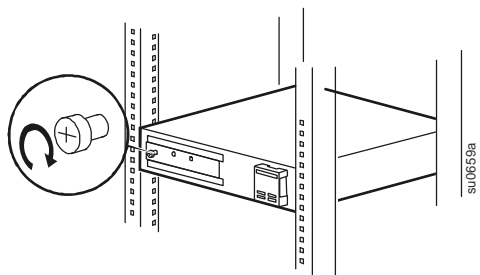

10

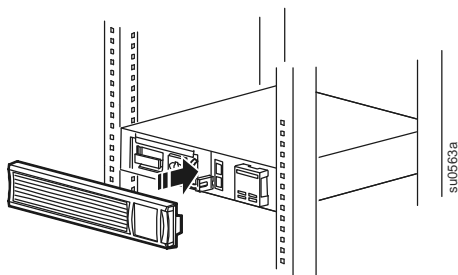

1000/1500 VA models

1

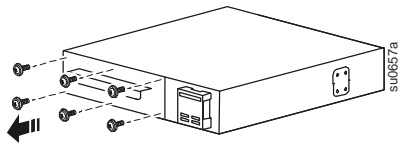

2

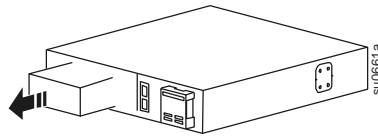

3

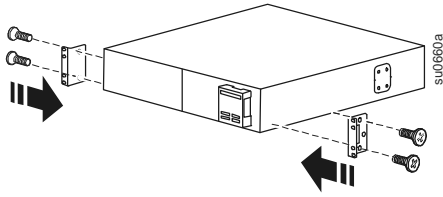

4

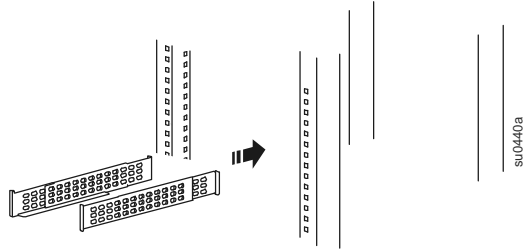

5

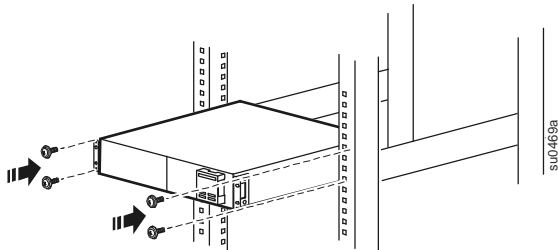

6

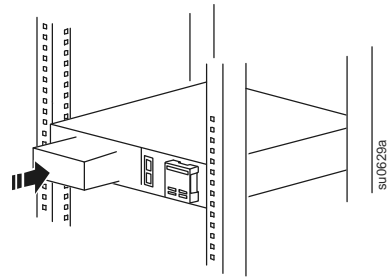

7

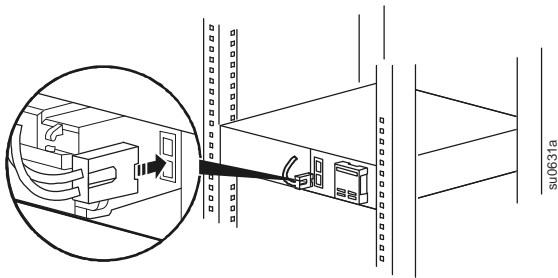

8

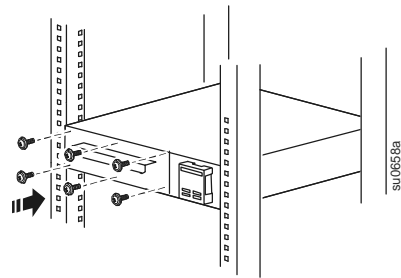

9

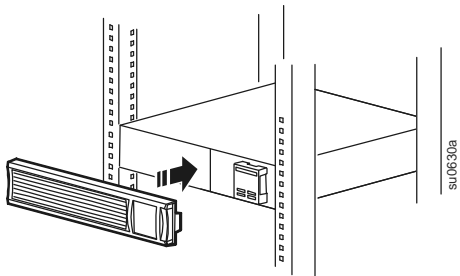

2200/3000 VA models

1

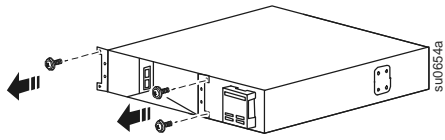

2

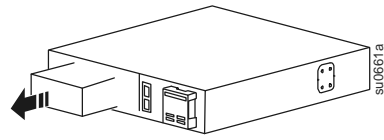

3

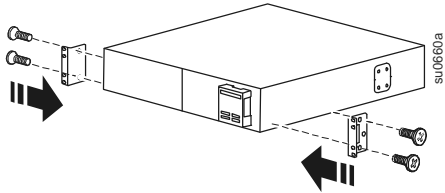

4

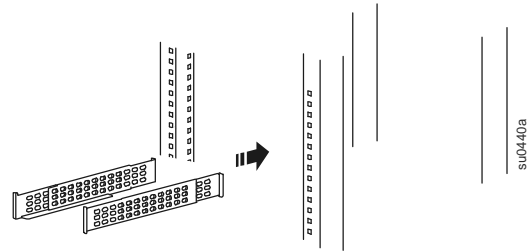

5

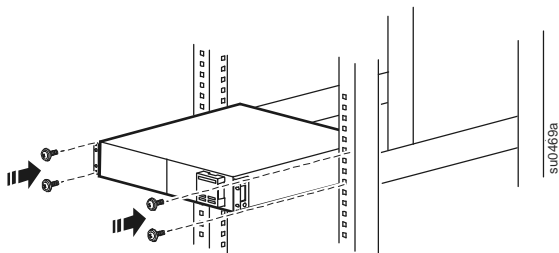

6

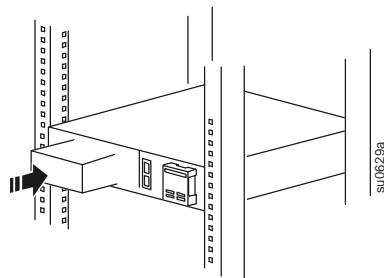

7

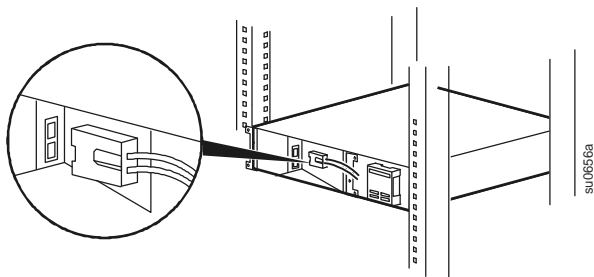

8

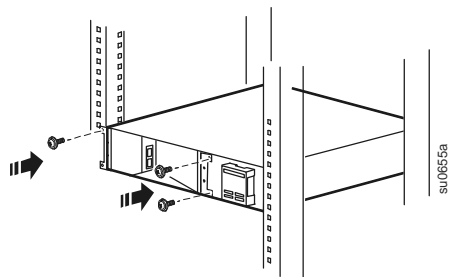

9

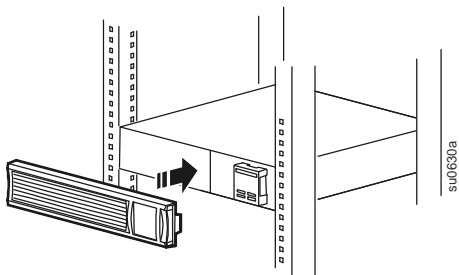

Overview and Start Up

Rear panel features

- ❶ SmartSlot for optional NMC accessory card
- ❷ UPS input
- ❸ Circuit breaker/Overload protection
- ❹ Controlled outlet group
- ❺ Chassis ground screw
- ❻ Outlets
- ❼ EPO connector
- ❽ USB port
- ❾ RJ45 connector - UPS monitoring serial port

750/1000 VA 120 Vac
1500 VA 100/120 Vac

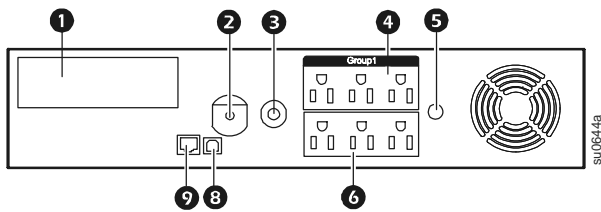

3000 VA 100/120 Vac

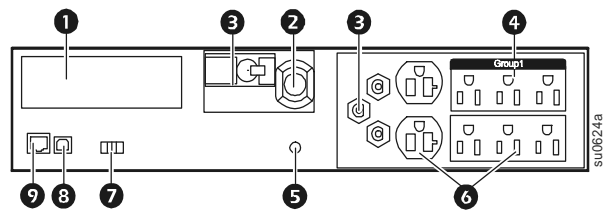

750/1000/1500 VA 230 Vac

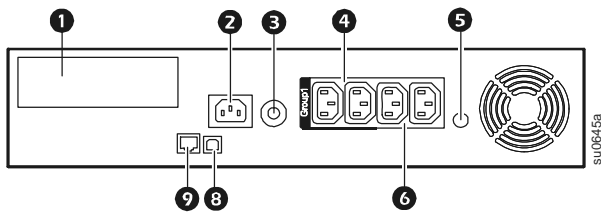

3000 VA 208 Vac

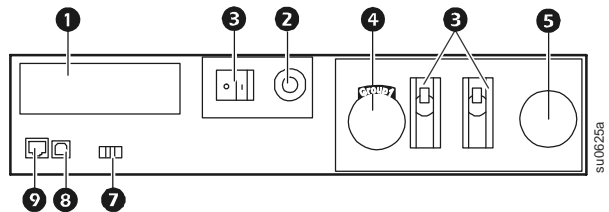

2200 VA 120 Vac

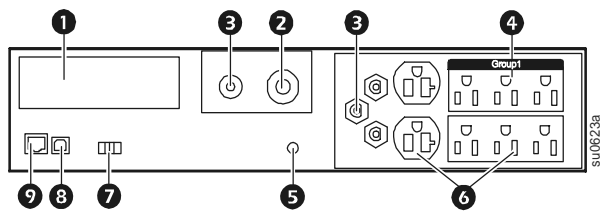

2200/3000 VA 230 Vac

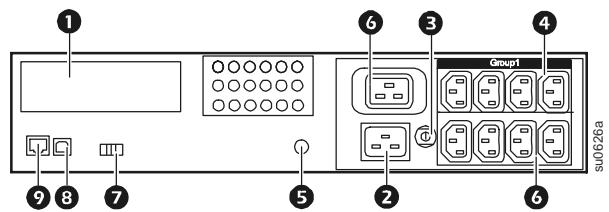

Electrical connections

⚠ CAUTION

DAMAGE TO EQUIPMENT OR PERSONNEL

- Adhere to all local and national electrical codes.
- Wiring should be performed by qualified electrician.
- Always connect the UPS to a grounded outlet.

Failure to follow these instructions can result in equipment damage and minor or moderate injury

Plug type and connector locations may vary.

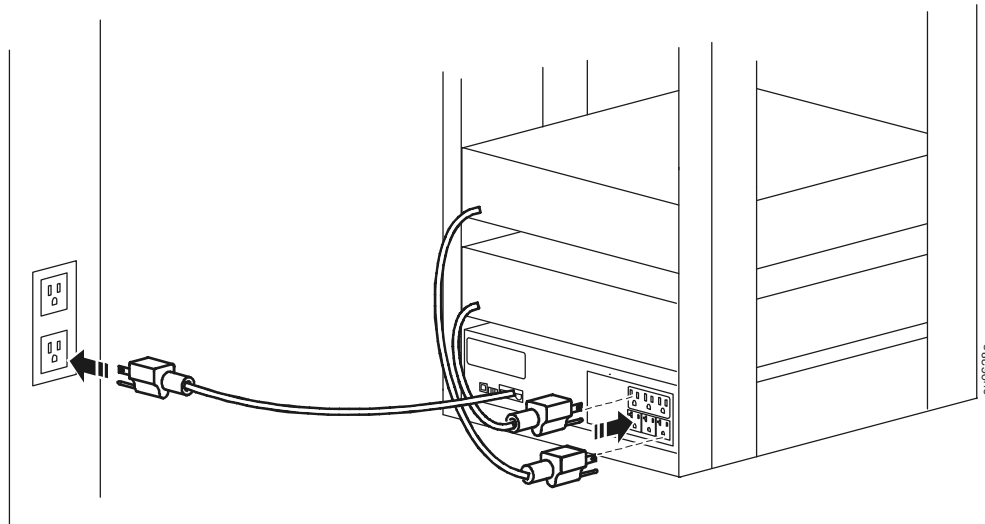

Display panel features

- ❶ Online LED
- ❷ UPS ON/OFF key
- ❸ On Battery LED
- ❹ Site Wiring Fault LED
- ❺ Replace Battery LED
- ❻ Display interface
- ❼ UP/DOWN arrow keys
- ❽ ENTER key
- ❾ ESCAPE key

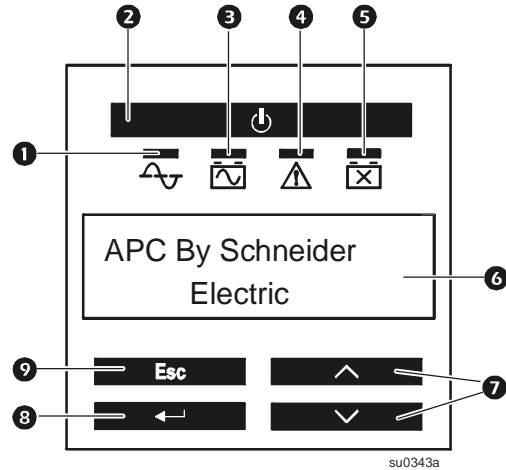

Controlled outlet groups

Some UPS models have one bank of outlets that can function as a controlled group. Use the display interface to configure the controlled outlet features, navigate to:

Main Menu > Control > Outlet1 Control.



Select models are ENERGY STAR[®] qualified.

For more information go to www.apc.com/site/recycle/index.cfm/energy-efficiency/energy-star/