

apollo

HIGH-RESOLUTION INTERFACE
with Realtime UAD Processing



Apollo FireWire Software Manual

Software Version 8

Manual Version 150428



UNIVERSAL AUDIO

Customer Service & Technical Support:

USA Toll-Free: +1-877-698-2834

International: +1-831-440-1176

www.uaudio.com

Table Of Contents

Tip: Click any section or page number to jump directly to that page.

Chapter 1: Introduction	4
Welcome To The Apollo Family	4
Software Features	5
Documentation Overview	7
Apollo Software Overview.....	9
Technical Support.....	11
Chapter 2: Installation & Setup	12
Apollo System Requirements	13
Installation On Windows Systems	14
Installation On Mac Systems.....	15
Optimizing FireWire Performance	16
Chapter 3: Console Application	19
Console Overview	19
The Console Window	23
Channel Input Strips.....	25
Inserts.....	30
Auxiliary Section.....	42
Monitor Section.....	46
Cue Returns (Apollo 16 only)	49
Console Settings Window.....	57
Window Title Bar.....	62
Application Menus.....	64
Chapter 4: Console Recall Plug-In	68
Console Recall Overview	68
Console Recall Controls	69
SYNC	70
Chapter 5: Unison	72
What is Unison?	72
Unison INPUT Inserts	74
Controlling Unison Plug-Ins with Apollo	76

Unison Load/Save Behaviors	82
Unison Operation Notes.....	83
Chapter 6: Working With Apollo.....	85
Apollo Setups Overview	85
About UAD Powered Plug-Ins Processing.....	86
Using Apollo as an Audio Interface	88
Using Apollo with Console (without a DAW)	90
Using Apollo Without A Computer.....	91
Using Apollo with a DAW (without Console)	92
Using Apollo Concurrently with a DAW and Console.....	95
Virtual I/O	97
PT Mode.....	99
Chapter 7: Multi-Unit Cascading	101
Multi-Unit Overview	101
Multi-Unit Wiring Diagrams.....	102
Multi-Unit Operation	104
Chapter 8: Latency & Apollo	108
Delay Compensation with Apollo.....	108
Input Delay Compensation in Console	108
Latency Basics	111
Chapter 9: Device Drivers	114
Apollo Drivers Overview	114
Driver I/O Tables	115
Chapter 10: Glossary.....	128
Chapter 11: Index.....	135
Chapter 12: Notices.....	138
Disclaimer	138
End User License Agreement	138
Trademarks	138
Copyright	138

Chapter 1: Introduction



Welcome To The Apollo Family

Class-Leading 24-bit / 192 kHz Sound Quality

Designed to play a central role in modern studios, Apollo, Apollo Twin, and Apollo 16 incorporate a true “no compromise” approach to audio quality. Building upon decades of UA’s analog hardware heritage, they offer extremely high-resolution sonics, with the lowest THD and highest dynamic range in their class. Apollo’s top-end converters — and UA’s meticulous attention to circuit design — translate into greater accuracy and depth in your recordings, from tracking and overdubbing, to mixing and mastering.

***Note:** Throughout this manual, the use of “Apollo” refers to both Apollo and Apollo 16 unless noted otherwise.*

Realtime UAD Plug-In Processing for Tracking, Mixing, and Mastering

While Apollo’s “natural” sound is exceedingly open and transparent, it can quickly deliver a wide range of classic analog tones and color via its Realtime UAD Processing. Available with SOLO, DUO, or QUAD Core processing onboard, this onboard DSP Acceleration allows for recording and mixing through UAD Powered Plug-Ins — with as low as sub-2ms latency — so producers can quickly monitor, audition, and optionally “print” audio using classic analog emulations from API, Ampex, Lexicon, Manley, Neve, Roland, SSL, Studer, and more.*

***Important Fundamental Concept:** Apollo’s low-latency hardware input monitoring and Realtime UAD Processing requires use of the included Console software application to take advantage of these features. Console replaces the software monitoring feature of the DAW mixer.*

* All trademarks are recognized as property of their respective owners. Individual UAD Powered Plug-Ins sold separately.

Software Features

Note: For a list of hardware features, see the [Apollo Hardware Manuals](#).

Console Application

General:

- Enables Realtime UAD Powered Plug-Ins processing on all inputs
- Analog-style mixer for realtime monitoring and tracking with UAD plug-ins
- Remote control of Apollo hardware features and functionality
- Console settings can be saved/loaded for instant recall of any configuration

Realtime UAD Processing:

- Up to four UAD plug-ins can be serially chained on each input and aux return
- UAD insert processing can be monitored “wet” while recording wet or dry
- Sub-2ms round-trip latency with four serial UAD plug-ins at 96 kHz sample rate

Channel Inputs:

- Input channels for all interface hardware inputs (*except MADI with Apollo 16*)
- Level, pan, solo, and mute controls on all inputs
- Four plug-in insert slots per input for Realtime UAD processing
- Two stereo auxiliary sends with level and pan controls on all inputs
- Virtual inputs accept any outputs from DAW via device drivers
- Stereo headphone sends with level and pan controls on all inputs*
- Four stereo cue sends with level and pan controls on all inputs*
- Adjacent input pairs can be linked for convenient stereo control
- Sample rate conversion is available on S/PDIF and AES/EBU inputs*
- Any input can be routed to any output

Monitoring:

- Stereo monitor mix bus with level, mute, solo clear, and source select controls
- Independent headphone buses; switchable to monitor mix and/or mirror to any output*
- 4 stereo cue mix buses; switchable to monitor mix and/or mirror to any output (*Apollo 16*)
- Independent monophonic sum controls for all mix buses
- S/PDIF and AES/EBU outputs can optionally mirror the post-fader monitor mix*

Auxiliary and Cue Buses:

- Two stereo auxiliary returns with independent level, mute, and mono sum controls
- Four plug-in inserts per auxiliary return for Realtime UAD Processing
- Auxiliary buses can be routed to main monitor mix or headphone & cue outputs*
- Auxiliary & cue buses can be routed to any output*
- Independent pre/post switching on each auxiliary bus

**Specific software features depend on hardware functionality not available with all Apollo devices. Details within.*

Metering:

- Signal level meters with peak hold and clip indicators on all inputs
- Dual pin-style peak meters with signal peak LEDs display monitor bus levels
- Input meters are globally switchable to display pre or post fader signal levels
- Independently selectable peak/clip hold times and global clear clips button

Console Recall plug-in

- Convenient access to Console's monitor controls via DAW plug-in
- Saves complete Apollo configurations inside DAW projects for easy recall of settings
- VST, RTAS, AAX 64, and Audio Units plug-in formats

UAD Powered Plug-Ins

- Award-winning audio plug-ins for monitoring, tracking, mixing, and mastering
- UAD plug-ins can be used simultaneously within Console and/or DAW
- All UAD plug-ins include fully-functional 14-day demo period
- Complete UAD plug-ins library is available online at www.uaudio.com

UAD Meter & Control Panel application

- UAD Control Panel configures global UAD-2 and UAD Powered Plug-Ins settings
- UAD Meter monitors UAD-2 DSP resources and FireWire bandwidth

Device Drivers

- 64-bit device drivers and plug-ins for Mac OS X and Windows 7*
- Supports multi-unit cascading and multi-client output
- All hardware inputs and outputs can be individually addressed by DAW
- All of Console's mix buses can be routed to DAW inputs for recording

Documentation Overview

Documentation for all Apollo components is extensive, so instructions are separated by areas of functionality, as detailed below. All documentation is copied to the computer during software installation (documentation can also be downloaded from our website).

All manuals are in PDF format. PDF files require a free PDF reader application such as Adobe Reader (Windows) or Preview (included with Mac OS X). After software installation, all Apollo documentation can be found on the startup drive at the following location locations:

Mac OS X

- /Applications/Universal Audio

Windows 7

- Start>All Programs>UAD Powered Plug-Ins>Documentation

Tip: Documentation can also be found by clicking the Documentation button in the Help panel within the UAD Meter & Control Panel application.

Apollo Hardware Manuals

The Apollo Hardware Manual and Apollo 16 Hardware Manual (available separately) contain complete information about the audio interface hardware. Included are detailed descriptions for all Apollo hardware features, control functions, and connections. Refer to the Apollo Hardware Manuals to learn all about interfacing the hardware with other devices, operating the panel controls, clocking, specifications, and related information.

Apollo Software Manual

The Apollo Software Manual is the companion guide to the Apollo Hardware manuals. It contains detailed information about how to configure and control Apollo's software features using the Console application and Console Recall plug-in. Refer to the Apollo Software Manual to learn how to operate these software tools and integrate Apollo's audio interface functionality into the DAW environment.

UAD System Manual

The UAD System Manual is the complete operation manual for Apollo's UAD-2 functionality and applies to the entire UAD product line. It contains detailed information about installing and configuring UAD devices, the UAD Meter & Control Panel application, how to use UAD plug-ins within a DAW, obtaining optional plug-in licenses at the UA online store, and more. It includes everything about UAD except Apollo-specific information and individual UAD Powered Plug-In descriptions.

UAD Plug-Ins Manual

The features and functionality of all the individual UAD Powered Plug-Ins is detailed in the UAD Plug-Ins Manual. Refer to that document to learn about the operation, controls, and user interface of each plug-in that is developed by Universal Audio.

Direct Developer Plug-Ins

UAD Powered Plug-Ins includes plug-ins from our Direct Developer partners. Documentation for these 3rd-party plug-ins are separate files that are written and provided by the plug-in developers themselves. The filenames for these plug-ins are the same as the plug-in title names.

Thunderbolt Option Card (Apollo & Apollo 16 only)

All user documentation for the Thunderbolt Option Card is located on the Thunderbolt Support Page on our website (there is no separate manual). Please review the information on the page carefully before installing or using the device:

- www.uaudio.com/support/thunderbolt-support

Host DAW Documentation

Each host DAW application has its own particular methods for configuring audio interfaces and using plug-ins. Refer to the host DAW's documentation for specific instructions about using audio interface and plug-in features within the DAW.

Helpful videos about setting up Apollo with various DAWs are available on our website:

- www.uaudio.com/videos

Hyperlinks

Links to other manual sections and web pages are [highlighted in blue text](#). Click a hyperlink to jump directly to the linked item.

Tip: Use the “back” button in the PDF reader application to return to the previous page after clicking a hyperlink.

Information & Software Updates

The latest technical information and software for Apollo is posted on the Universal Audio website. Our support pages may contain updated, late-breaking information that is not available in other publications. Please visit the support page for your device:

- www.uaudio.com/support/apollo

Glossary

This manual uses technical terms and acronyms that may be unfamiliar. Refer to [“Chapter 10: Glossary” beginning on page 128](#) for the definitions of many of these terms.

Apollo Software Overview

Apollo has several software components that comprise the complete Apollo system. A brief description of each component is provided below, along with a link to complete details about the component.

Console Application

The Console application is Apollo's primary software interface. Its main function is to control the hardware unit and its digital mixing and monitoring capabilities. The Console mixer is where Realtime UAD processing using UAD Powered Plug-Ins is configured.

Important Fundamental Concept: *The primary function of Console is to control Apollo's low-latency hardware input monitoring and Realtime UAD Processing, and Console must be used to take advantage of these features. Console replaces the software monitoring feature of the DAW mixer.*

For complete details, see [“Chapter 3: Console Application” beginning on page 19.](#)

Console Recall Plug-In

Console Recall is a DAW plug-in supplied in VST, RTAS, AAX 64, and Audio Units formats. Console Recall offers additional convenience when using Apollo and/or the Console application in conjunction with a DAW. Its primary function is to store complete Console configurations within the DAW project file.

For complete details, see [“Chapter 4: Console Recall Plug-In” beginning on page 68.](#)

UAD Powered Plug-Ins

UAD Powered Plug-Ins are the software plug-in titles containing the DSP algorithms. UAD plug-ins are loaded within a host application for audio processing on Apollo's integrated UAD-2 DSP accelerator (Console and DAWs are host applications). Each UAD plug-in contains a graphical user interface (GUI) and various control parameters that can be manipulated to achieve the desired sonic results.



Typical UAD plug-in window

Apollo includes numerous UAD Powered Plug-Ins that are bundled with the device. Optional UAD plug-ins can be evaluated without functional limitations for 14 days in demo mode. Optional plug-in licenses can be purchased at the [UA online store.](#)

For additional details about how UAD Powered Plug-Ins are used with Console and DAWs, see [“About UAD Powered Plug-Ins Processing” on page 86](#). For general UAD Powered Plug-Ins usage instructions, see the UAD System Manual. For complete details of individual UAD Powered Plug-Ins, see the UAD Plug-Ins Manual.

UAD Meter & Control Panel Application

The UAD Meter & Control Panel Application is used to configure global functionality that pertains to all UAD-2 devices in the same system (the same application is used for all UAD-2 products). All UAD-2 global system settings are set within this application. The application consists of two components: The UAD Meter and the UAD Control Panels.

UAD Meter

The UAD Meter window (at right) displays the current DSP, memory, and FireWire status of all active UAD-2 hardware (including multiple devices). These meters are also present in Console, beneath the main output level meters.

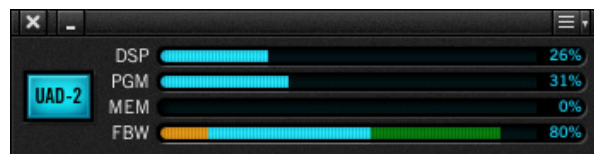

UAD Control Panels

The UAD Control Panel window has multiple panels that display, and enable control of, the various UAD-2 system, plug-in, and global configuration parameters.

The screenshot at right shows the System Info panel, one of five control panel windows in the UAD Meter & Control Panel application.

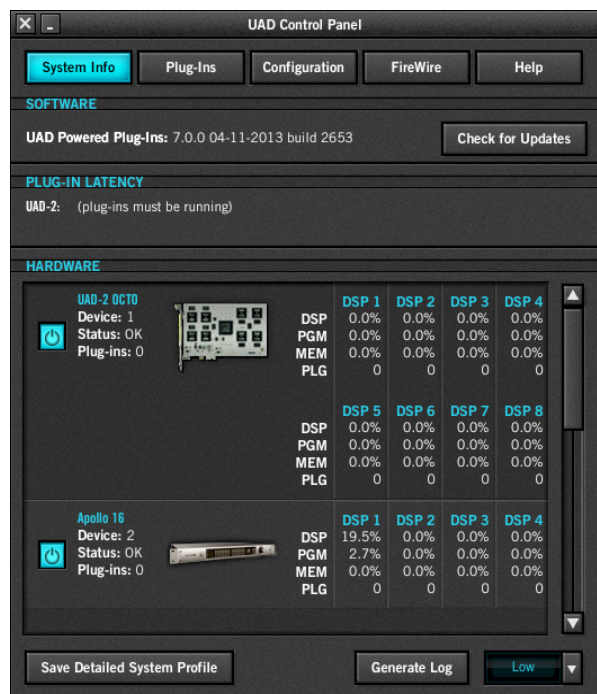

Accessing UAD Meter & Control Panel

The application can be accessed (after software installation) from the Mac OS X Dock or the Windows Start Menu. See [page 22](#) for details.

Details About the Application

Complete documentation for the UAD Meter & Control Panel application is in the UAD System Manual.

Apollo Device Drivers

The Apollo device drivers are the low-level system software files that instruct the computer’s operating system on how to communicate with the Apollo hardware. The drivers are loaded during system startup so whenever Apollo is connected, the interface is ready to accept instructions from the OS and audio applications.

For complete details, see [“Chapter 9: Device Drivers” beginning on page 114](#).

Technical Support

Universal Audio provides free customer support to all registered Apollo users. Our support specialists are available to assist you via email and telephone during our normal business hours, which are from 9am to 5pm, Monday through Friday, Pacific Standard Time.

Telephone

USA toll-free: +1-877-698-2834
International: +1-831-440-1176

Online Support

To request online support via email, please visit the main support page at www.uaudio.com/support, then click the blue “Submit Support Ticket” button on the right side of the page to create a help ticket.

A blue rectangular button with white text that reads "SUBMIT SUPPORT TICKET »".

Or, simply click the link below for a direct link to the help ticket form:

- <https://www.uaudio.com/my/support/create/>

Users Forum

The unofficial UAD Powered Plug-Ins users forum, for the exchange of tips and information, is on the web at:

- www.uadforum.com

Chapter 2: Installation & Setup

Simplified procedures for software installation, registration, and authorization are in this chapter. For complete and detailed procedures (including offline authorization), refer to the [UAD System Manual](#). For hardware installation notes and diagrams, refer to the [Apollo Hardware Manuals](#). If you need technical assistance, contact [Technical Support](#).

The UAD Installer places all the software necessary to configure and use Apollo and UAD Powered Plug-Ins onto the computer's startup disk. It also installs the Apollo hardware device drivers so the audio interface can communicate with the host computer. Therefore the UAD Installer must be run even if you intend to use Apollo without the use of Console or UAD Powered Plug-Ins functionality.

Installation, registration, and authorization consists of these main steps (detailed later):

1. (Windows only): Install a [qualified PCIe-to-FireWire](#) adapter card.
2. Install the software and hardware: The installation ordering depends on the OS; follow the specific instructions for your platform.
3. Optimizing FireWire performance: Adjust the UAD Bandwidth Allocation setting based upon your particular operating environment.

Software Updates

The most recent UAD Powered Plug-Ins software version is always recommended so you'll have access to the latest UAD plug-ins. The most recent software is available at the UA website: www.uaudio.com/downloads

Firmware Updates

For optimum results, always update the firmware if prompted by the software. A confirmation dialog will appear after the firmware update is complete; power Apollo off then on again to complete the process before attempting to use the software.

Preparation

Close all open files and applications before starting the software installation procedure. The installer requires a restart after installation.

If you are updating to a newer version of Apollo software or installing additional UAD devices, it is not necessary to remove the previous UAD software or hardware from the system.

Automatic Authorization

As of UAD v8.0, authorization is fully automatic. Simply restart the computer and authorization is accomplished automatically in the background.

Important: *Registration and authorization can only be accomplished after successful software installation.*

Apollo System Requirements

Windows

- Windows 7 64-bit Edition
- Qualified PCIe-to-FireWire 800 adapter card (list is [published here](#))

Mac

- Mac OS X 10.8.5 Mountain Lion, 10.9.x Mavericks, or 10.10 Yosemite
- Available FireWire 800 port

All Platforms

- Four gigabytes available disk space
- 1024 x 800 minimum display resolution
- Internet connection to download software and authorize UAD plug-ins
- For additional compatibility information, visit www.uaudio.com/support
- For installation software, visit www.uaudio.com/download

Installation On Windows Systems

Install the PCIe to FireWire 800 Adapter Card First

Important: On Windows computers, the [qualified PCIe-to-FireWire 800 adapter card](#) must be installed and configured correctly **before** installing the UAD software or connecting Apollo.

Install UAD software before connecting Apollo

Important: If you are installing UAD Powered Plug-Ins for the first time, install the software before installing the UAD device(s). This is important for “plug-and-play” functionality.

Apollo Installation Procedure (Windows)

1. Confirm the [qualified PCIe-to-FireWire 800 adapter card](#) is installed before connecting Apollo or installing the UAD software.
2. Download the UAD Powered Plug-Ins software installer from: www.uaudio.com/downloads
3. Open the software installer by double-clicking the downloaded software archive. Setup will guide you through the installation procedure.
4. Restart the computer when prompted by the installer.
5. After restarting, connect Apollo to AC power and the PCIe card's FireWire 800 port, then power on Apollo. The Apollo drivers will load and the default web browser will open.

Important: If prompted to update the UAD firmware, click “Load” then wait for confirmation that the process is complete. UAD devices must be powered off then on after a firmware update to complete the firmware update process.

6. Follow the instructions on the web pages to create an account, register the hardware, and claim bundled UAD plug-ins.
7. **Important!** Adjust the FireWire bandwidth setting to maximize Apollo performance. See [Optimizing FireWire Performance](#) for details.
 - After registration is complete, Apollo is automatically authorized and ready for use.
 - If the device was already registered, when the computer restarts the UAD Meter & Control panel automatically opens and UAD plug-ins are automatically authorized in the background.

Installation On Mac Systems

Connect and power Apollo before installing the software

Important: For optimum results, connect and power the Apollo hardware before installing the UAD software.

Apollo Installation Procedure (Mac)

1. Connect Apollo to a FireWire 800 port on the computer.
2. Connect Apollo to AC power with the included power cable, then power on the device with the power switch.
3. Open the UAD Powered Plug-Ins software installer downloaded from the UA website: www.uaudio.com/download
4. The UAD software installer will guide you through the installation process.

Important: If prompted to update the Apollo firmware click "Load" then wait for confirmation that the process is complete. Apollo must be powered off then on after a firmware update to complete the firmware update process.

5. Restart the computer when prompted by the installer.
6. When the computer restarts, the default web browser will open and connects to the UA online store. Follow the instructions on the web pages to create an account, register the hardware, and claim bundled UAD plug-ins.
7. **Important!** Adjust the FireWire bandwidth setting to maximize Apollo performance. See [Optimizing FireWire Performance](#) for details.
 - After registration is complete, Apollo is automatically authorized and ready for use.
 - If the device was already registered, when the computer restarts the UAD Meter & Control panel automatically opens and UAD plug-ins are automatically authorized in the background.

Optimizing FireWire Performance

About FireWire Bandwidth

FireWire bandwidth is shared between Apollo I/O streams, UAD plug-ins used within the DAW, and external FireWire hard drives. Available bandwidth also depends on the session sample rate; the higher the sample rate, the more bandwidth is consumed.

FireWire bandwidth is displayed in the “FBW” meter in the UAD Meter & Control Panel application:

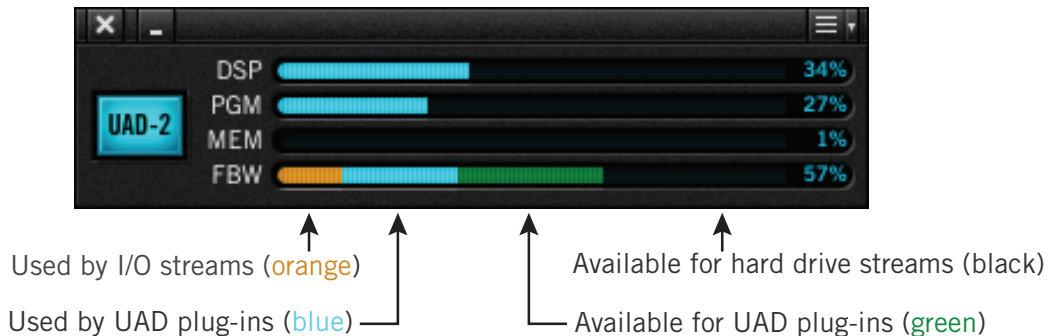

The FireWire Bandwidth meter in the UAD Meter & Control Panel application

UAD Bandwidth Allocation

The UAD Bandwidth Allocation setting reserves FireWire bandwidth for UAD plug-ins used within a DAW. It has no effect on UAD plug-ins used in Console, nor when connected to the host computer via Thunderbolt. The default value (65%) a good starting point for most single-unit users; it should be adjusted according to your particular environment. Use the values in the table below as starting points when tuning the UAD Bandwidth Allocation. The values apply for both Apollo and Apollo 16.

Note: If using sample rates of 44.1 kHz or 48 kHz, we recommend increasing the UAD Bandwidth Allocation setting from the default of 65% to allow more UAD plug-ins to run within the DAW when external FireWire hard drives are not used.

Recommended UAD Bandwidth Allocation Values (single unit)					
		Sample Rate (kHz):	44.1, 48	88.2, 96	176.4, 192
Without external FireWire hard drive	Mac:		80%	65%	55%
	Win:		75%	55%	45%
With external FireWire hard drive	Mac:		55%	40%	25%
	Win:		30%	25%	15%
I/O buffer setting for best playback results:			512	1024	2048

Note: See ["Multi-Unit FireWire Bandwidth"](#) on page 105 for recommended values when multi-unit cascading.

To change the UAD Bandwidth Allocation setting:

1. Quit all DAW software and the Console application (UAD hosts must be quit to change this setting).
2. Open the UAD Meter & Control Panel application. It can be accessed via the following methods:
 - (Mac) Click its icon in the OS X Dock
 - (Win) Select it from Start Menu>All Programs>UAD Powered Plug-Ins
3. Open the FireWire panel by clicking the menu button in the UAD Meter window and choosing “FireWire” from the drop menu, or type ⌘-F (Mac) or Ctrl-F (Windows) as a shortcut.



4. Change the UAD Bandwidth Allocation setting (shown below) by clicking the up or down arrows, or click/hold the value for a drop menu.
5. See [UAD Bandwidth Allocation Notes](#) on the next page for more information about this setting.

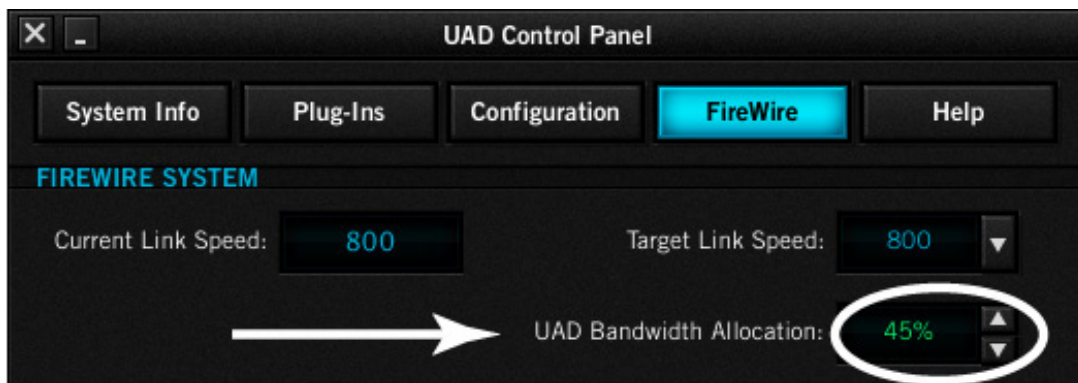

UAD Bandwidth Allocation Notes

- UAD Bandwidth Allocation values in the table are recommended as starting points for FireWire bandwidth tuning. Depending on external FireWire hard drive usage (e.g., how many audio tracks are being streamed), lower values may be needed for increased FireWire hard drive loads, or higher values can be used for increased UAD plug-in counts when FireWire hard drive usage is lower. To run more UAD plug-ins within a DAW, use USB, eSATA, or internal hard drives for audio session files instead of FireWire drives.
- Apollo has intelligent FireWire bus monitoring. If audio playback is compromised, a “FireWire Interrupt Detected” dialog appears. If that occurs, decrease the UAD Bandwidth Allocation setting for reliable playback. Note that even if the dialog appears during playback, audio file integrity is never compromised during recording.
- The UAD Bandwidth Allocation only applies when UAD plug-ins are used within a DAW. UAD plug-ins do not consume any FireWire bandwidth when used within Console, nor when connected to the host computer via Thunderbolt.
- (Mac) FireWire performance is better on some systems versus others due to the FireWire controller chips they contain. In general, newer Mac Pro, iMac, and Mac mini systems contain a superior FireWire controller chip and will deliver better FireWire performance than MacBook Pro systems. There is no simple method to determine which controller is used.

Chapter 3: Console Application

Console Overview

The Console application is the main software interface for the Apollo hardware. Console's analog-style workflow is designed to provide quick access to the most commonly needed features in a familiar, easy-to-use interface.

Console's function is to control the hardware units and their digital mixing and monitoring capabilities. The Console Mixer is where Realtime UAD Processing using UAD Powered Plug-Ins is configured and operated.

Console can be used simultaneously with a DAW for front-end processing and monitoring functionality. Complete Console setups can be saved as presets for easy recall of the entire configuration. Console can also be used to configure Apollo's audio interface I/O settings such as sample rate, clock source, and reference levels.



Important Fundamental Concept: *The primary function of Console is to control Apollo's low-latency hardware input monitoring and Realtime UAD Processing. Console MUST be used to take advantage of these features. Console replaces the software monitoring feature of the DAW mixer.*

Note that the Console application is a remote interface to the digital mixing and signal processing functions that are performed within the Apollo hardware. Although Console runs on the host computer, the computer's CPU is not performing these audio functions.



Apollo's Console application window

Console Functions

Console enables the following functionality when used with Apollo:

- **Hardware control.** Apollo’s front panel hardware controls (except headphone volume) can be controlled using Console, facilitating easy hardware control even if Apollo is installed in a location out of reach of the host computer operator.
- **Buffer-free monitoring.** Using Console eliminates DAW I/O buffering and its associated latency that makes monitoring and recording problematic for the performer. By removing the DAW and its “software monitoring” feature from the monitoring signal flow altogether, buffering and latency become non-issues.
- **Realtime UAD processing.** UAD Powered Plug-Ins can be inserted into all Console inputs and/or auxiliary returns (within available DSP resources), for the ultimate sonic experience while monitoring and/or tracking live performances. All processed (or unprocessed) mix buses, including the monitor, auxiliary, headphone, and cue buses, can be optionally routed into the DAW for recording.
- **Unison.** Apollo’s Unison technology gives you the tone of the world’s most sought-after tube and solid state mic preamps — including their all-important impedance, gain stage “sweet spots,” and component-level circuit behaviors.
- **Flexible, independent monitor mixing and tracking.** Console has two pre/post stereo auxiliary buses, with independent send levels per input, for grouped signal processing (conserving DSP resources) or routing to alternate hardware outputs. Two stereo headphone mix buses (Apollo) or four stereo cue mix buses (Apollo 16) with per-input sends ensure individual performers can hear “more me” if desired.
- **Flexible signal routing.** Using Console, any hardware input can be routed to any hardware output (Apollo/Apollo 16 only). Additionally, all headphone (Apollo) and cue (Apollo 16) mix buses can be mirrored to any hardware output.
- **Session management.** Complete Console configurations can be saved and loaded to/from disk as presets, for convenient and unlimited session management. Sessions can also be stored within the DAW project using the Console Recall plug-in.

Global Settings

Parameters within the [Console Settings Window](#) panels are available for configuring various global behaviors:

- **Hardware.** Global interface settings such as sample rate, clock source, reference levels, and digital output mirroring are controlled in the Interface panel.
- **Software.** Global software settings for Console such as meter and plug-in window behaviors are configured in the Console panel.

Interactions Between Console and Apollo

Console’s settings mirror the Apollo hardware; changes made to one will be made on the other, and vice versa. If changes are made to Console when Apollo is not connected, then Apollo is subsequently connected, the Console settings are sent to the hardware.

Important: *If Console is launched after changes are made to Apollo using the front panel hardware controls, the current Console settings will overwrite the changes made using the hardware controls.*

When To Use Console

The Console application can be used without a DAW, simultaneously in conjunction with a DAW, or not at all. These scenarios are covered in greater detail in [“Chapter 6: Working With Apollo” beginning on page 85](#).

Console without DAW. Console can be used by itself without the use of a DAW or any other audio software. Using Console without a DAW provides access to all Apollo functionality and simplifies the use of Apollo’s digital mixing, monitoring, and Realtime UAD processing features when a DAW’s recording and playback features are not needed.

Console with DAW. Console is used at the same time as a DAW when low-latency monitoring and/or recording of Apollo’s inputs with (or without) Realtime UAD processing is desired. In this scenario, Console is used to control input monitoring when recording, and the DAW’s software monitoring feature is disabled. This workflow completely eliminates the I/O buffering latencies associated with using software monitoring via the DAW.

***Important:** To eliminate doubled signals, software monitoring in the DAW must be disabled when Console is used for input monitoring.*

UAD plug-ins can be used within Console and the DAW simultaneously. In this scenario, Apollo’s DSP resources are shared between the two applications. Realtime UAD processing is available via Console, and buffered (non-realtime) UAD processing is available via VST, RTAS, AAX 64, or Audio Units plug-ins within the DAW. See [“UAD Powered Plug-Ins: Console versus DAW” on page 85](#) for more details about this scenario.

Apollo Device Differences

Apollo and Apollo 16 have different hardware features, therefore the Console software reflects these differences. The Console interface that appears depends on which Apollo hardware model is connected to the computer. Any Console feature differences are specifically noted in this chapter.

The specific differences between Apollo audio interfaces are shown in the table below.

***Note:** In this manual, “Apollo” refers to all Apollo interfaces unless specifically noted otherwise.*

Primary I/O and routing differences between Apollo interface models	
Apollo	Apollo 16
8 analog line inputs (first four with Mic/Line/Hi-Z)	16 analog line inputs
10 digital inputs (S/PDIF, ADAT)	2 digital inputs (AES/EBU)
14 analog outputs (8 Line, 2 Mon, 4 HP)	16 analog line outputs
2 stereo headphone mix buses	Four stereo cue mix buses
Aux sends and returns can be routed to various outputs	Cue sends and returns can be routed to various outputs
Fixed monitor reference level	Selectable monitor operating level
Line input reference levels for channels 5–6, 7–8 switchable in pairs	Line input reference levels for channels 1–16 individually switched
4 dedicated virtual channels	8 dedicated virtual channels

Accessing Console

Console can be launched or quit at any time, whether or not a DAW is already running. Any of these methods can be used to launch the Console application under Mac OS X and Windows:

Mac:

- Select “Console” under the blue UA logo diamond the Mac OS X Menu Bar
- Click the Console application icon in the Mac OS X Dock
- Double-click the Console application, which is installed to: /Applications/Universal Audio/Console.app

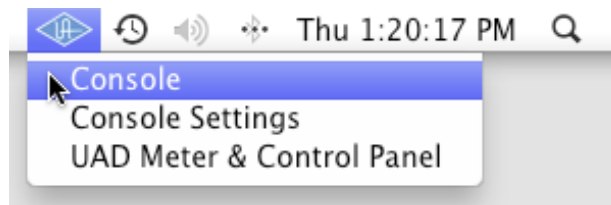

Accessing Console from the Mac OS X Menu Bar

Windows:

- Select “Console” from the Windows System Tray (blue UA diamond logo)
- Access the application from:
Start Menu>All Programs>UAD Powered Plug-Ins>Console

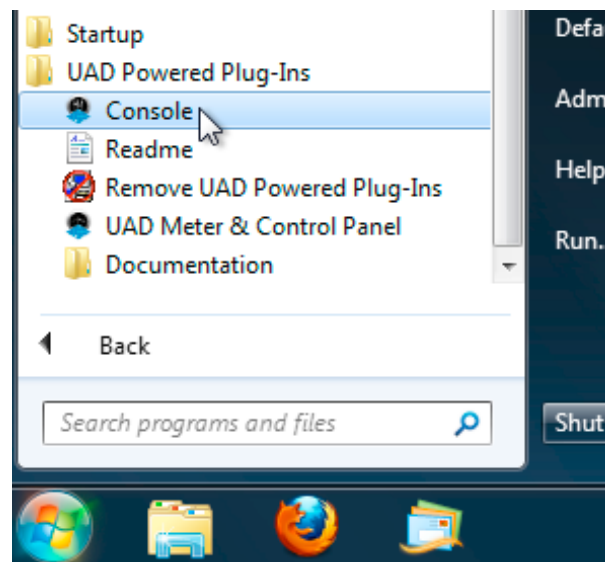

Accessing Console from the Windows Start Menu

The Console Window

Control Groups

Console controls are grouped according to functionality, with a layout similar to that found on typical analog mixers. The layout of these groupings is shown below. Detailed explanations of all the Console control functions are similarly grouped and presented later in this chapter.

Note: With Apollo 16, cue controls replace the headphone controls that are shown in the Apollo diagram below. However, the Apollo 16 cue controls are similarly grouped.

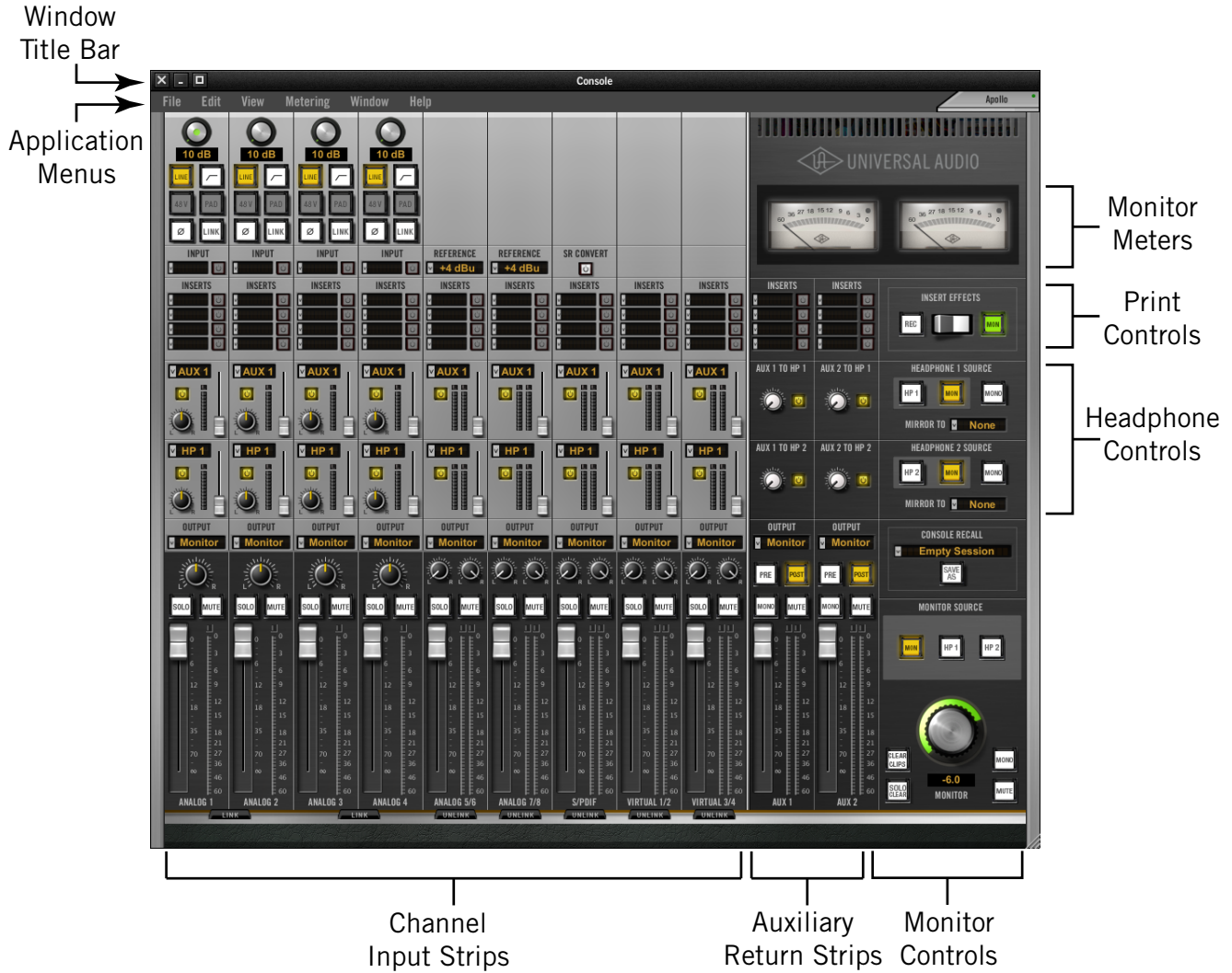

Console's main window and controls layout

Sizing the Console Window

The size of the Console window can be horizontally and vertically adjusted by dragging the lower right corner of the window. Reducing the mixer width will reduce the number of visible inputs. Use scrolling to view the hidden inputs.



Scrolling

When the window is sized to display fewer channels than are currently active, the window can be scrolled horizontally to bring the hidden channels into view. Similarly, if the window is vertically reduced by resizing, the window can be vertically scrolled to view the hidden portion.



Console's horizontal scroll bar

To scroll the mixer window, use any of these methods:

- Drag the scroll bar(s) with the mouse
- Click the scroll arrows at either end of the scroll bar(s)
- Hover over the scroll bar(s) and use the scroll function of the input device (scroll wheel, trackpad, etc).

Adjusting Console Controls

2-state buttons, switches, and checkboxes: Click to toggle the state.

Knobs: Click-drag to adjust, or use the shortcuts below. Console's rotary controls (and UAD plug-in knobs) can respond to Linear, Circular, or Relative Circular adjustments modes. This preference is set in the UAD Meter & Control Panel application; full details are in the UAD System Manual.

Faders: Click-drag to adjust, or use the [Console Shortcuts](#).

UAD Powered Plug-Ins: Most UAD plug-in controls use the same methods as above. However, some plug-in parameters may have custom controls that are unfamiliar or not obvious. All custom controls are detailed for individual plug-ins in the [UAD Plug-Ins Manual](#).

Console Shortcuts

Several shortcuts are available to simplify Console control adjustments:

Scroll Wheel: Continuous controls (knobs and faders) can be adjusted by using the mouse scroll wheel (if available). Hover the cursor over the control and adjust the scroll wheel to modify the parameter value.

Adjust All: If the Option key is held down while modifying any control, the same control on all inputs (or aux returns) will be simultaneously adjusted. The relative difference is maintained between the same controls until any control reaches its minimum or maximum value.

Return To Default: If the Command (“⌘” or “apple” key – Mac) or Control “ctrl” key (Windows) is held when a control is clicked, the control will return to its default value. Command(Ctrl)+Option+Click will return all controls of the same type to their default value.

Mute/Solo All Toggle: Option-click a Mute or Solo button to toggle the state on all channels.

Shift+Click with Arrow Keys: After clicking a control, values can be adjusted using the arrow keys when the shift key is held down.

Button Toggle via Return: When a button has focus, it can be toggled with the return or enter keys on the computer keyboard. A button has focus after it is clicked.

Drop Menus: Menus continue to display after a single click. The mouse button does not need to be held down to view the menu.

Channel Input Strips

Each Console input strip controls the corresponding Apollo hardware input. The output of all Console channel input strips are always routed to Console's monitor outputs. Inputs can be optionally routed to other outputs via the [Auxiliary Section](#).

Console's channel input strips are essentially the same for all inputs, however there are some differences among the analog and digital inputs as noted below. Detailed descriptions of all controls begin on [page 27](#).

Input Types

Console has analog inputs, digital inputs, and virtual I/O inputs. The controls that are available in each strip depends on the type of input.

Inputs vs. Channels (Apollo)

Console's analog inputs reflect the *channels* of A/D conversion that are available in Apollo. Since there are actually more analog *inputs* (mic, line, Hi-Z) on the interface than *channels*, Console's preamp inputs are switched between the analog input connectors that are available on the hardware channels (like an analog mixing console with multiple input types per channel).

Preamp Inputs (Apollo)

The preamp channels are switched between mic and line inputs manually via Console or Apollo's front panel. Channels are automatically switched to Hi-Z inputs when a 1/4" mono (tip-sleeve) cable is connected to Apollo's front panel Hi-Z input jack.

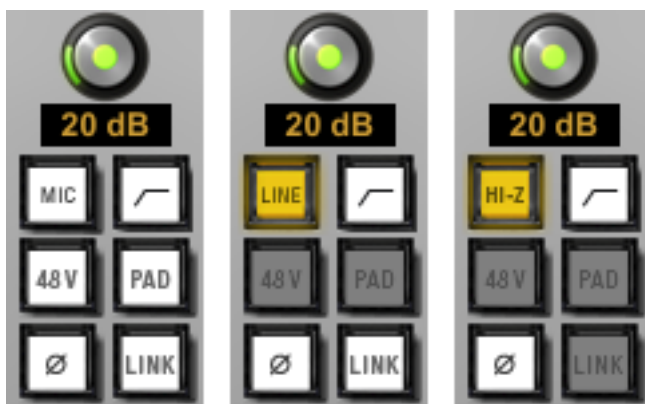

Console's preamp modes (Apollo only):
Mic (left), Line (center), and Hi-Z (right)

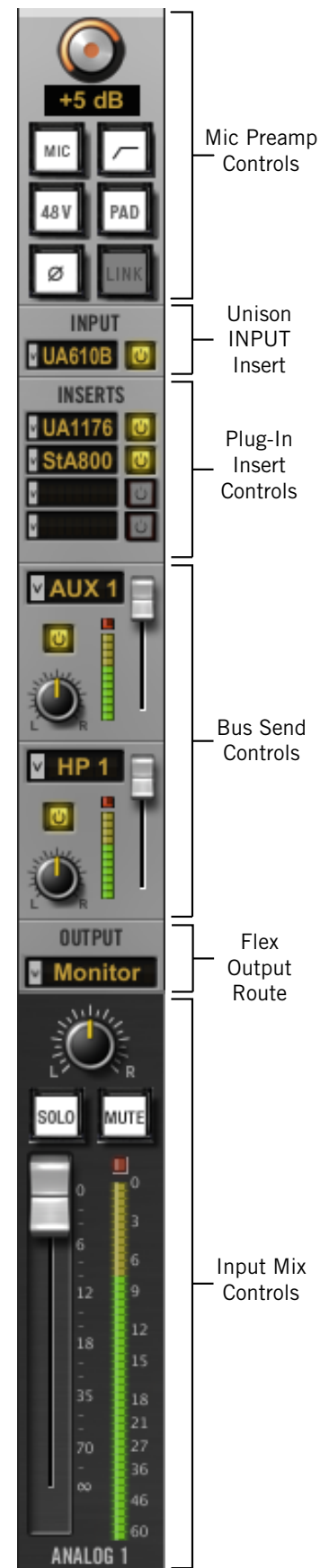

Channel input strip

Analog Inputs (Apollo 16)

Console's 16 analog line inputs reflect the 16 channels of A/D conversion that are available in Apollo 16 (Apollo 16 does not have preamp channels).

Digital Inputs

Apollo

Console's eight ADAT and two S/PDIF (stereo left and right) inputs work just like the analog inputs, except they don't have the extra preamp and reference level settings that are only available on the analog inputs.

Apollo 16

Console has two AES/EBU inputs (left and right). MADI inputs are not available in Console (MADI on Apollo 16 is used for multi-unit cascading only).

Sample Rate Conversion

Realtime sample rate conversion ("SR Convert") is available on the S/PDIF and AES/EBU inputs. This feature eliminates audio artifacts (clicks, distortion, etc) that can occur when the sample rate of external digital devices connected to the S/PDIF or AES/EBU inputs do not match Apollo's internal sample rate.

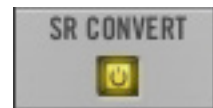

To enable realtime sample rate conversion on Apollo's S/PDIF or AES/EBU inputs, click the SR Convert button in Console's associated channel strip. The feature is active when the button is yellow.

Sample Rate Conversion notes:

- SR Convert is available on S/PDIF or AES/EBU inputs only (not ADAT or MADI)
- SR Convert applies to both L/R inputs (they can't be individually enabled)
- SR Convert functions on both L/R inputs whether or not they are stereo linked
- SR Convert is unavailable when Apollo's clock source is set to S/PDIF or AES/EBU
- SR Convert is unavailable on digital outputs

Virtual Inputs

The virtual input channels in Console do not reflect Apollo's hardware inputs. Instead, they receive signals from DAW outputs via Apollo's device drivers, enabling Realtime UAD Processing on any DAW output. This feature is especially useful when playing virtual software instruments live through UAD plug-ins because it reduces I/O buffering latency. For complete details about this feature, see ["Virtual I/O" on page 97](#).

Channel Input Controls

Preamp Controls (Apollo)

Console's preamp controls correspond to the equivalent preamp controls on the Apollo front panel. Adjusting Apollo's front panel will update Console (and vice versa); see [“Interactions Between Console and Apollo” on page 20](#) for details.

Unison™

Unison is an exclusive analog/digital integration technology that's built into every Apollo microphone preamplifier. The preamp controls in Console interact extensively with Unison plug-in parameters. For complete Unison details, see [“Chapter 5: Unison” beginning on page 72](#).



Gain

The channel's preamp gain can be adjusted with this control. The input to be adjusted (Mic, Line, or Hi-Z) is determined by the state of the channel's Mic/Line switch or the Hi-Z input (if connected).

Rotating the knob clockwise increases the preamp gain for the channel. The available gain range for the preamp channels is 10 dB to 65 dB for the Mic, Line, and Hi-Z inputs.

Gain Amount

The specific amount of preamp gain in decibels is displayed beneath the gain control. The relative amount of preamp gain is indicated by the green “LED ring” surrounding the gain control. The LED ring is a different color when Unison is active in the channel.

Front Panel Channel Selection Indicator Dot

The colored dot that appears in the center of a gain knob indicates the preamp channel that is currently selected on Apollo's front panel (Apollo's channel selection is changed using the front panel).

Unison Parameter

Gain is a Unison parameter that interacts with Unison plug-ins inserted in the INPUT slot. See the Unison chapter for more information.

Mic/Line

This button switches between the mic and line inputs on Apollo's rear panel. The button text and color depends on the preamp input selection.

The Mic/Line button has no effect if the channel's Hi-Z input is connected, because preamp channels are automatically switched to the Hi-Z input when a ¼” mono (tip-sleeve only) cable is connected to Apollo's front panel Hi-Z input jack.



Low Cut Filter

When enabled, the channel's input signal passes through a low cut (high pass) filter. This 2nd-order coincident-pole filter has a cutoff frequency of 75 Hz with a slope of 12 dB per octave by default (the filter can change when Unison is active in the channel).



The Low Cut filter effects the Mic, Line, and Hi-Z inputs. Low Cut is typically used to eliminate rumble and other unwanted low frequencies from the input signal.

Unison Parameter

The low cut filter is a Unison parameter that interacts with Unison plug-ins inserted in the INPUT slot. See the Unison chapter for more information.

48V

When enabled, the 48V button is red and 48 volts of phantom power is supplied to the Apollo channel's rear panel Mic input. Most modern condenser microphones require 48V phantom power to operate. This option can only be activated when the Mic/Line switch is set to Mic.



Depending on the current configuration of the Apollo and Console, there may be a delay when changing the 48V state to minimize the clicks/pops that are inherent when engaging phantom power. The +48V LED on Apollo's front panel will flash during any delay.

Unison Parameter

48V is a Unison parameter that interacts with Unison plug-ins inserted in the INPUT slot. See the Unison chapter for more information.

Pad

When enabled, the PAD button is yellow and the channel's microphone input signal level is attenuated by 20 dB. Pad does not effect the Line or Hi-Z inputs.



Pad is used to reduce signal levels when overload distortion is present at low preamp gain levels, such as when particularly sensitive microphones are used on loud instruments, and/or if the A/D converter is clipping.

Unison Parameter

Pad is a Unison parameter that interacts with Unison plug-ins inserted in the INPUT slot. See the Unison chapter for more information.

Polarity

When enabled, the polarity (aka "phase") button is yellow and the input channel's signal is inverted. Polarity affects the Mic, Line, and Hi-Z inputs.



Polarity inversion can help reduce phase cancellations when more than one microphone is used to record a single source.

Unison Parameter

Polarity is a Unison parameter that interacts with Unison plug-ins inserted in the INPUT slot. See the Unison chapter for more information.

Link

This button links the controls of adjacent preamp channels together (1 & 2, or 3 & 4) to create stereo input pairs. When channels are linked as a stereo pair, the Link button is yellow and any preamp control adjustments will affect both channels of the stereo signal identically.



Note: Only the same type of inputs can be linked (Mic/Mic or Line/Line), and the Hi-Z inputs cannot be linked.

This button has the same function as the Link button which is available on all Console inputs. See “Stereo Link” on page 41 for more detail.

Note: For preamp channels, input pairs can also be stereo linked and unlinked via Apollo’s front panel.

Reference Level

The signal reference level for all analog line inputs can be switched between –10 dBV and +4 dBu with this drop menu. The setting controls an attenuation pad for the input channel.

When set to +4 dBu, the pad is engaged and the channel can accept a higher signal level before the A/D converter clips. Select –10 dBV when lower input signal levels are used.

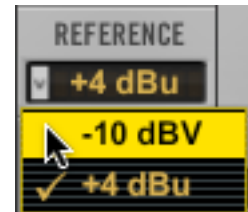

To adjust signal incoming levels for the analog inputs, use the output level controls of the devices that are connected to those inputs.

Tip: Additional gain can be added to input signals by inserting UAD plug-ins and adjusting the gain structure within the plug-ins.

The availability and behavior of the reference level control depends on the hardware model:

Apollo

The reference level for channels 5 & 6 and 7 & 8 are linked in Apollo’s hardware; therefore the reference level in Console can only be switched according to these stereo pairs.

Apollo 16

The reference level for all analog input channels 1 – 16 can be individually switched.

Inserts

The Inserts section is where UAD Powered Plug-Ins are selected and used for Realtime UAD Processing. Four insert slots are available per Console strip; therefore up to four UAD plug-ins can be serially stacked (chained) per input within the constraints of available DSP resources.

Important: UAD Powered Plug-Ins within Console use DSP differently than when used within a DAW. To maintain the lowest possible input latency, UAD plug-ins used on a single Console channel strip must fit within a single DSP processor. Therefore, it is possible to get a “DSP load limit exceeded” message even though the UAD Meter may indicate there is enough DSP available.

General UAD plug-ins usage instructions are in the UAD System Manual. See the UAD Plug-Ins Manual for specific details about individual UAD Powered Plug-Ins.

Unison INPUT Insert

Apollo’s Unison technology is activated when a Unison-enabled UAD pre-amp or pedal plug-in is loaded in the special INPUT insert slot which is above the standard insert slots. Console INPUT inserts are only available on Apollo’s preamp channel inputs. See the [Unison](#) chapter for complete details about this feature.



Note: Unison (and the INPUT insert) is unavailable with Apollo 16, which does not feature microphone preamplifiers.

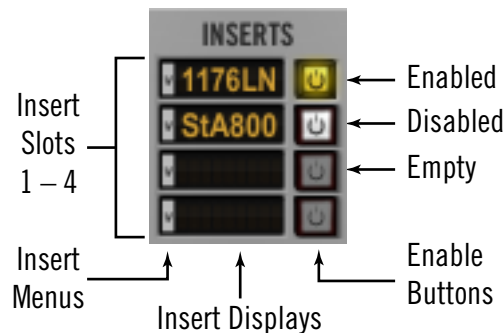

Console’s insert controls

Insert Menu

Clicking the insert menu on any insert slot will display the list of available UAD Powered Plug-Ins and the options sub-menu. Click an item in the displayed list to select the item.



Access UAD plug-ins by clicking an Insert Menu

Selecting a UAD plug-in from the list will load the plug-in into the insert slot; selecting an item from the options sub-menu will perform that function.

If the slot does not already contain a plug-in, clicking anywhere in the Insert Display will show the list (the area is dark when no plug-in is loaded). If a plug-in is already loaded in the slot, clicking near the “v” drop-menu indicator on left of the Insert Display will show the list.

Tip: Right-click (or Ctrl-click) the slot to display the Insert Menu even if a plug-in is already loaded in the slot (you don't need to click near the “v” drop-menu indicator to display the list in this case).

Insert Display

The insert display shows the name of the currently loaded plug-in (if any). An abbreviated name is shown for longer plug-in names due to space constraints.

Tip: Hovering the mouse over the Insert Display shows the full plug-in name in a pop-up window.

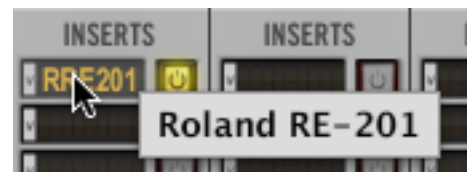

Insert Disable

The insert disable button (see [Console's insert controls](#)) can be used to disable/re-enable the plug-in that is in the slot. It performs the same function as turning off the plug-in within its interface.

When the plug-in is active, the button is yellow. When disabled, the button is white.

Insert Options Menu

The Insert Options menu is displayed when the mouse is hovered over the “Options” text (at the top-left of the plug-ins list) in all insert menus.

Insert Options

The available options in the Insert Options Menu vary depending on the state of the insert and the copy/paste clipboard. Each Option function is described below.

Note: All copy/paste functions also copy/paste the current settings of the plug-in.

Show Channel Strip Editor – This feature (Mac only) groups and displays the interfaces of all plug-ins currently loaded in the inserts of a strip in a single window, offering a convenient method of organizing channel plug-in windows. The single window, containing up to four plug-in GUIs, can be moved and arranged on screen as desired in a single motion.

Due to operating system differences, the Channel Strip Editor is unavailable in Windows.

Tip: To open the Channel Strip Editor, command-click any Console insert slot containing a UAD plug-in.



The Channel Strip Editor

Copy “Plug-In Name” – Copies the plug-in that is in the slot so it can be pasted into another slot via the Options menu “Paste” command. This option does not appear if a plug-in is not loaded in the slot.

Copy “Plug-In Name” To This Insert On Visible Inputs – Copies the plug-in that is in the slot into the same slot of all visible inputs. This option does not appear if a plug-in is not loaded in the slot.

Note: In the above context (and those below), “Visible Inputs” means all Console inputs that are currently displayed via the [View Menu](#).

Copy “Plug-In Name” To This Insert On All Inputs – Copies the plug-in that is in the slot into the same slot of all inputs (visible or not). This option does not appear if a plug-in is not loaded in the slot.

Paste “Plug-In Name” – Pastes the plug-in (that was previously copied) into the slot. This option does not appear if a plug-in was not previously copied via the Options menu.

Paste “Plug-In Name” To This Insert On Visible Inputs – Pastes the plug-in (that was previously copied) into the same slot of all visible inputs. This option does not appear if a plug-in was not previously copied via the Options menu.

Paste “Plug-In Name” To This Insert On All Inputs – Pastes the plug-in (that was previously copied) into the same slot of all inputs (visible or not). This option does not appear if a plug-in was not previously copied via the Options menu.

Bypass All Plug-Ins On This Channel – Disables all plug-in processing in all slots of the channel.

Enable All Plug-Ins On This Channel – Enables all plug-in processing in all slots of the channel.

Bypass All Plug-Ins – Disables all plug-in processing on all channels.

Enable All Plug-Ins – Enables all plug-in processing on all channels.

Remove All Plug-Ins On This Channel – Unloads all plug-ins from all insert slots in the channel.

Remove All Instances of “Plug-In Name” On This Insert On All Inputs – Unloads all plug-ins that have the same name from all slots in the channel (if any).

Remove All Plug-Ins – Unloads all plug-ins from all slots in all channels.

Bus Sends

Overview

The bus sends are used to send Console's input signals to the auxiliary, headphone (Apollo), and cue (Apollo 16) buses. Each send has independent level, pan, and enable controls. All auxiliary, headphone, and cue mix buses in Console are stereo, and all these buses are always active.

The two auxiliary mix buses are typically used to create reverb or delay returns for monitoring with effects.

Apollo

Apollo's two headphone mix buses are typically used to create independent stereo mixes for Apollo's headphone outputs.

Apollo 16

Apollo's four cue mix buses are typically used to create independent stereo mixes that can be routed to any Apollo 16 output for use with outboard gear such as headphone distribution systems.

Visible Sends

Each Console input channel has two visible sends. The visible sends for each channel are selected with the two send menus that are available on each input channel. When a send bus is selected with the send menus, the bus is selected for all inputs, providing a convenient visual reference for the mix state of the bus.

The visible sends can optionally be unique for each channel if desired, by holding the option key (Mac) or alt key (Windows) while selecting the send bus.

Note: Two mix buses are displayed concurrently, but all mix buses are always active.



Console's bus sends

Send Menu

The currently displayed bus is selected with the send menu. Click the send menu to display the drop menu containing the available send buses.

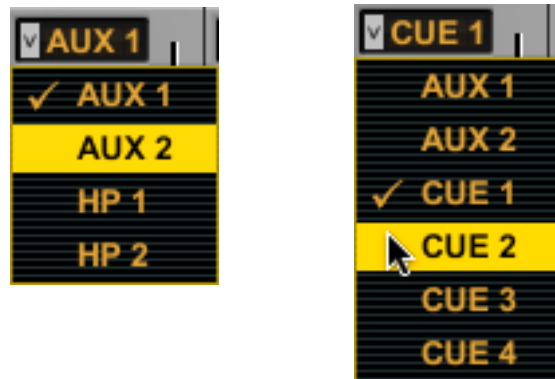

The bus send menus with Apollo (left) and Apollo 16 (right)

Select for all inputs

Select a bus from the drop menu to display the bus send in all input channels. This method provides a convenient visual reference for the mix state of the bus.

Select for unique input

To display the send bus only in one channel only (as shown below), option+click (Mac) or alt+click (Windows) while selecting a bus from the menu.



The bus sends showing unique selections for each input

AUX 1, 2

When aux 1 or 2 is selected, the channel's input signal can be mixed to the respective auxiliary bus returns in Console.

By default, the aux sends are post-fader and post-mute. The aux sends can be switched to be pre-fader and pre-mute. The [Aux Pre / Aux Post](#) function switch for each aux is located in the respective auxiliary bus return strip.

Note: See [“Auxiliary Section” on page 42](#) for complete overview of Console's aux design.

HP (Apollo)

When HP 1 or 2 is selected, the channel's input signal can be mixed to the respective headphone bus. The headphone sends are pre-fader and mute.

***Note:** If the headphone source selector is set to MON, the headphone mix bus is not heard and the headphone sends have no effect.*

CUE (Apollo 16)

When cue 1 – 4 is selected, the channel's input signal can be mixed to the respective cue bus. The cue sends are pre-fader and mute

***Note:** If the cue source selector is set to MON, the cue mix bus is not heard and the cue sends have no effect.*

Send Level

The send level fader adjusts the amount of input channel signal sent to the currently selected bus.

Send Meter

The Send Meter displays the post-fader signal level of the currently selected Channel Send.

Send Pan

The send pan controls adjust the input's position in the stereo field of the currently selected send bus. The pan knobs are not displayed when the input is in linked mode (example at right), which forces the stereo channels to automatically pan hard left/right.

Send Disable

The send disable button can be used to disable/re-enable the bus send. When the send is active, the button is yellow. When disabled, the button is white.

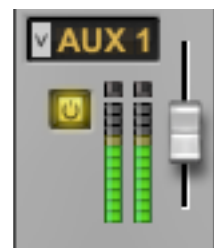

Flex Routing

By default, Console's input channels are routed to the monitor outputs only. However, Console's input channels can be optionally routed (assigned) to any Apollo hardware output. A maximum of eight channel output route assignments are available.



Note: Flex Routing is unavailable at sample rates of 176.4 kHz and 192 kHz.

Output Menu

To change the channel output routing, select an output (or output pair, for stereo linked channels) from the channel output menu. To display the channel output menu, click anywhere in the channel output route display.

The number of currently available mono and stereo channel output routes is displayed in gray text at the bottom of the menu.

Important: The channel output route in Console overrides DAW output channels assigned to the same hardware output.

Multiple input signals cannot be merged to the same output(s) using the output menu. However, multiple input signals can be merged using the Auxiliary, Headphone (Apollo), and Cue (Apollo 16) buses, and these buses can be assigned to any available output pair.

Note: If an output in the menu is dim and cannot be selected, the output route is already in use by another channel, aux, headphone (Apollo), or cue (Apollo 16).



Mirror to Monitor

When a channel is routed to an output other than the monitor outputs, the channel is simultaneously routed to the monitor outputs (mirrored) by default. Mirroring to the monitor outputs can be disabled so the channel is routed only to the output selected in the output menu.

To toggle monitor mirroring, select "Mirror to Monitor" from the output menu. Monitor mirroring is active when a check mark appears next to the "Mirror to Monitor" text in the menu.

Input Pan

This control adjusts the input's position in the stereo panorama of the monitor mix bus.

When the input is stereo linked, two pan knobs appear for the channel – one for each of the left and right channels – enabling independent panning for both the left and right channels. When stereo link is activated, the default position of the dual pan knobs are hard left/right.



Pan with channels unlinked (left) and linked (right)

Input Mute

Mute stops the input channel's signal from being routed to the monitor mix bus (and aux buses that are in POST mode), but not the headphone (Apollo) or cue (Apollo 16) buses. The channel is muted when the mute button is red. The input meter is still active when the channel is muted for a visual reference that there is still a signal coming into the channel even though it isn't heard in the monitor mix.



Tip: Option-click the mute button to toggle mute on multiple channels.

If Solo is activated on the same channel when muted, the mute state is overridden and the channel is heard in the monitor mix.

Note: Input mute does not affect the channel input headphone or cue sends.

Input Solo

Solo mutes all input signals, except for any inputs in solo mode. Solo is used to highlight individual channels in the mix without having to modify other channels.



Tip: Option-click the solo button to toggle solo on multiple channels.

The channel is solo'd when its solo button is yellow. Activating mute on a channel has no effect if the channel is in Solo mode.

Note: Input solo does not affect the channel's headphone sends (Apollo) or cue sends (Apollo 16).

Channel Fader

This is the channel's main signal level control for the Console monitor mix. It always affects the channel's level in the monitor mix bus (the monitor outputs) and both aux mix buses (the aux outputs), but not the headphone (Apollo) or cue (Apollo 16) mix buses. Changes to this control are reflected in the channels level meter.

Fader Scale

The numerical labels represent the amount of attenuation applied by the fader. A value of "0" represents 0 db of attenuation.

Fader Level Hover



If the mouse is hovered over the fader "handle" its current decibel value is displayed in a pop-up window.



Channel Fader & Input Meter

Copy Mix Menu

All channel fader values for all inputs (the entire monitor mix) can be copied simultaneously to any send bus.

To copy the monitor mix to a send bus, right-click (or Ctrl-click) the channel fader to display the copy mix menu, then select a destination bus for the mix.

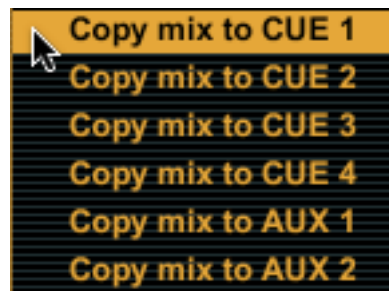
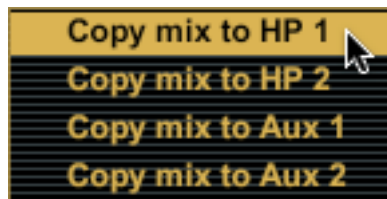

The copy mix menus with Apollo (left) and Apollo 16 (right)

Caution: The Copy Mix function will overwrite the entire mix of the destination bus (all send level settings for all inputs on the destination bus will be lost).

Input Meter

The Input Meter displays the signal level of the channel after UAD plug-in processing in the inserts. Depending on the state of the View Menu (post-fader or pre-fader), this meter will display the level going into the monitor mix bus (post-fader/post-inserts), or the level at the channel's hardware input (pre-fader/post inserts).

Tip: When recording into a DAW, it's generally better to keep the Input Meters set to pre-fader so they accurately represents the signal level being sent to the DAW.

Input Level Scale

The numerical labels represent digital signal levels. “0” represents 0 dBFS (digital full scale, the maximum level before undesirable A/D clipping). If the level at the Apollo input exceeds 0 dBFS, the meter’s clip indicator illuminates (reduce the preamp gain and/or output level of the device feeding the input if this occurs).

These meters also have a peak hold feature, which “holds” signal peak values for a specified period of time. The clip and peak hold times can be adjusted in the [Console Settings Panel](#).

Input Label

The name of the Console input is displayed beneath the channel’s fader and meter.

Console Input Labeling

Console input labels can be customized. Custom names are displayed in a brighter white color to differentiate from the default name.

To customize any Console channel input name:

1. Click an input label. The rename field appears.
2. Type a new name for the input.
3. Press Return or Enter.

To return to the default name:

1. Click an input label. The rename field appears.
2. Click the default input name that appears above the rename field.
3. Press Return or Enter.



Labeling a Console Input Strip

Console Input Labeling Notes

- To view the default name on an input that has a custom name, click the input label. The default name appears above the custom name. Press Return or Enter to hide the default name.
- Custom input labels are a global function (they are not stored in session files).
- Custom input labels are visible in Console only.

Stereo Link

Adjacent channels can be linked to create stereo input pairs by clicking the LINK button at the bottom of the channel strip. When channels are linked as a stereo pair, any control adjustments will affect both channels of the stereo signal identically.

Activation

Stereo pairs are created by clicking the LINK button at the bottom of two adjacent channel strips. For preamp channels (Apollo only), clicking the LINK button within the preamp controls performs the exact same function pressing the LINK button on Apollo's front panel.

Caution: All channel strip controls and plug-in settings in the right channel are overwritten when LINK is activated.

When Link is activated:

- The LINK button text changes to UNLINK
- One set of controls is available for the stereo channel (except Pan, as noted below)
- All current control settings of the left channel are copied to the right channel (except Pan, as noted below)
- All inserted plug-ins in the left channel are converted to stereo (parameter values are retained)
- The input pan knob changes to dual pan knobs
- Pan values are forced to hard left and hard right
- The send pan knobs are hidden from the interface (pans are forced hard left/right stereo sends)
- The Channel Meter changes to a stereo level meter

Deactivation

The stereo pair is separated back into individual channels by clicking the UNLINK button. When LINK is deactivated, all current control settings and inserted plug-ins for the stereo channel are copied to both channels (except Pan, which is centered for both channels).

Link Constraints

- Odd-numbered channels can only be linked to the next even-numbered channel (for example, Analog 1 can be linked to Analog 2, but Analog 2 cannot be linked to Analog 3).
- Only the same type of inputs can be linked (for example, an analog input can only be linked to an analog input).
- For preamp channels (Apollo), only the same input jacks can be linked (for example, a Mic input cannot be linked to a Line input).
- The Hi-Z inputs cannot be linked.

Tip: Stereo Link can be activated and deactivated on all channels simultaneously by option-clicking the stereo link button. However, *use caution with this feature so all right-channel settings are not unintentionally lost.*

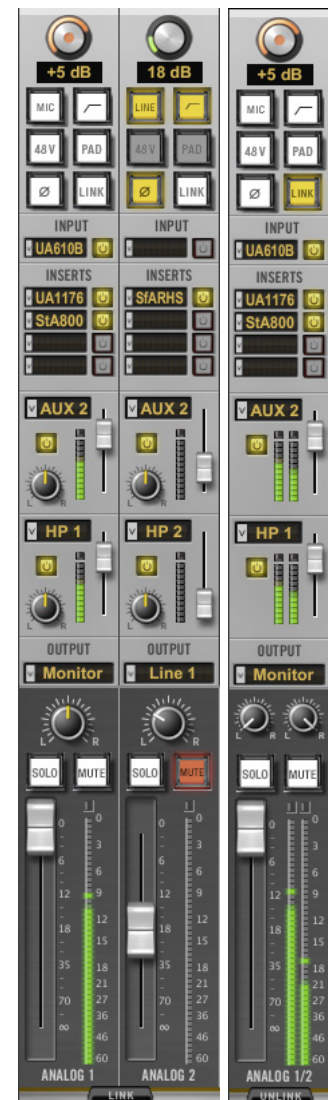

Before and after engaging stereo LINK

Auxiliary Section

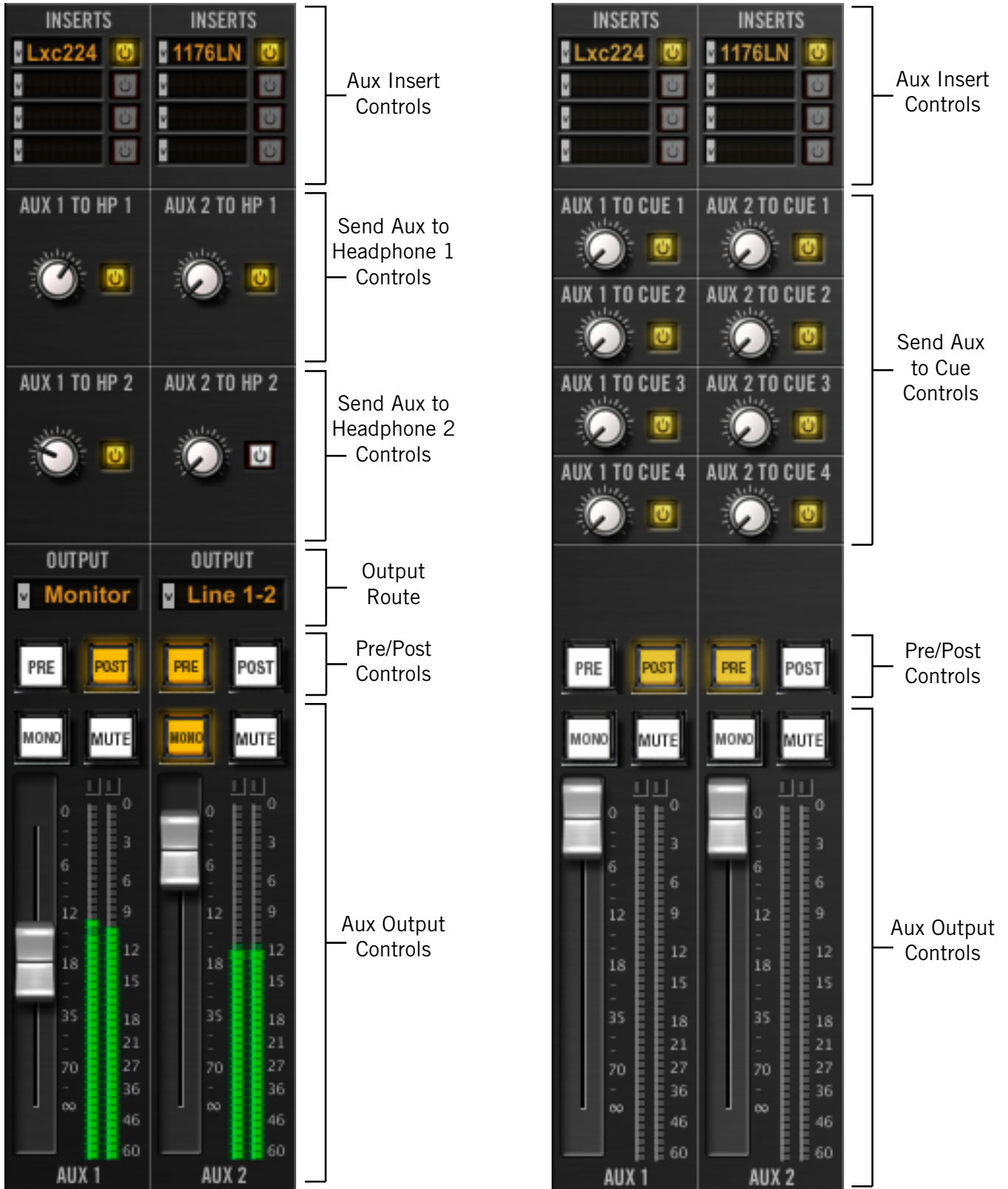

Console's aux return controls with Apollo (left) and Apollo 16 (right).

Aux Overview

Console has two stereo auxiliary (aux) mix buses. Signals are sent to the aux buses via the aux sends in Console's channel input strips; Console's aux returns then control and process the signals that are received from those sends.

The controls in Console's aux return strips are similar to the channel input strips, but instead of controlling a channel input, they control the output of the aux mix bus. Both stereo aux returns have four insert slots for Realtime UAD Processing.

The aux sends can be post-fader and post-mute (channel faders must be up and unmuted to be routed to the aux bus, and the send levels will reflect channel fader changes), or pre-fader and pre-mute (channel faders and mutes do not affect the aux bus).

The aux buses in Console are designed primarily for send/return processing using UAD plug-ins. Using aux buses for effects is a great way to conserve UAD DSP resources. For example, by using an aux for reverb processing, only one reverb plug-in is needed on the aux return instead of putting a reverb plug-in on each individual channel.

Aux Notes:

- For the control descriptions, refer to the diagrams on [page 42](#).
- Aux 2 is unavailable at sample rates of 176.4 kHz and 192 kHz.
- The outputs of the auxiliary buses have 32 samples of additional latency compared to the monitor outputs. This is necessary to maintain the lowest possible latency for the dry signals.
- (Apollo only) Aux 2 is unavailable when multi-unit cascading.

Aux Return Strips

Both of Console's aux return strips are identical. Most of the controls have identical functionality as their equivalent control in the channel input strips. In these cases, cross-references to the same control in the channel strips are provided instead of repeating the description.

Aux Inserts

The aux insert slots, insert menu, insert display, and insert disable buttons all have identical functionality as the channel insert controls in the input strips. See "[Inserts](#)" on [page 30](#) for complete descriptions of the Insert controls.

Aux Headphone 1 & 2 Controls (Apollo only)

Aux Headphone 1 & 2 Send (Apollo)

The AUX TO HP knobs send the aux return to the associated headphone mix bus. There is no headphone pan knob on the aux returns, because the aux returns are stereo.

Note: When Headphone Source ([page 48](#)) is set to HP, aux returns must be sent to the headphone mix bus via these controls for the aux to be heard in the headphones.

Aux Headphone 1 & 2 Enable (Apollo)

This button can be used to disable/re-enable the aux headphone sends. When the send is active, the button is yellow. When disabled, the button is white.

Aux Cue Controls (Apollo 16 only)

Aux Cue Sends (Apollo 16)

The aux returns can be routed to any of the four cue mix buses using the AUX TO CUE knobs on the aux returns. There is no cue pan knob on the aux returns, because the aux returns are stereo.

***Note:** When the Cue Source (page 50) is set to cue, aux returns must be sent to the cue mix bus via these controls for the aux to be heard in the cue.*

Send To Cue Enable (Apollo 16)

Each aux cue send can be individually enabled. When the aux cue send is active, the button is yellow. When disabled, the button is white.

Aux Output Route (Apollo only)

***Tip:** The aux outputs can be virtually routed to DAW inputs via the device drivers. See “Virtual I/O” on page 97 for related information.*

Apollo

The aux returns can be routed to any pair of hardware outputs for additional routing flexibility. The aux output drop-menu specifies which pair of hardware outputs the aux bus is routed to. By default, the Monitor outputs are selected.

***Note:** If an output in the menu is dim and cannot be selected, the output route is already in use by another channel or aux.*

Apollo 16

The aux returns are always routed to the monitor outputs.

Aux Pre

When the Pre button is engaged (yellow), the aux mix bus is pre-fader and pre-mute. In Pre mode, the channel faders and mutes do not affect the aux bus.



***Tip:** Pre-fader mode is useful for configuring a mix bus that is completely independent from the main channel controls (for example, when creating additional cue mixes with Apollo).*

Aux Post

Post-fader is the default setting for Aux 1 and 2. When the Post button is engaged (yellow), the aux mix bus is post-fader and post-mute. In Post mode, the channel faders must be up and unmuted to be routed to the aux bus, and the aux send levels will reflect channel fader changes.



Tip: Post-fader mode is typically used when configuring an effect send mix so the effect sends will interact with the main channel controls.

Aux Mono

This button sums the left and right channels of the stereo aux output into a monophonic signal. The aux return output is stereo when the button is white and mono when the button is yellow.

Aux Mute

Note: Aux mute does not mute the aux bus return's headphone sends (Apollo) or cue sends (Apollo 16).

Apollo

The aux mute button stops the aux return's signal from being routed to the output assigned in the [Aux Output Route \(Apollo only\)](#) menu. The aux is muted when the mute button is red.

Apollo 16

The aux mute button stops the aux return's signal from being routed to the monitor mix.

Aux Fader

This is the master signal level control for the aux bus return. It does not affect the aux bus return's headphone sends (Apollo) or cue sends (Apollo 16).

Aux Meter

The Aux Meter displays the signal level of the aux bus return. The "0" label represents 0 dbFS (digital full scale, the maximum level before undesirable D/A clipping). If the level at the aux output exceeds 0 dbFS, the meter's clip indicator illuminates (reduce the levels feeding the aux if clipping occurs).

The Aux Meters have a peak hold feature, which "holds" signal peak values for a specified period of time. The clip and peak hold times can be adjusted in the [Console Settings Panel](#).

Monitor Section

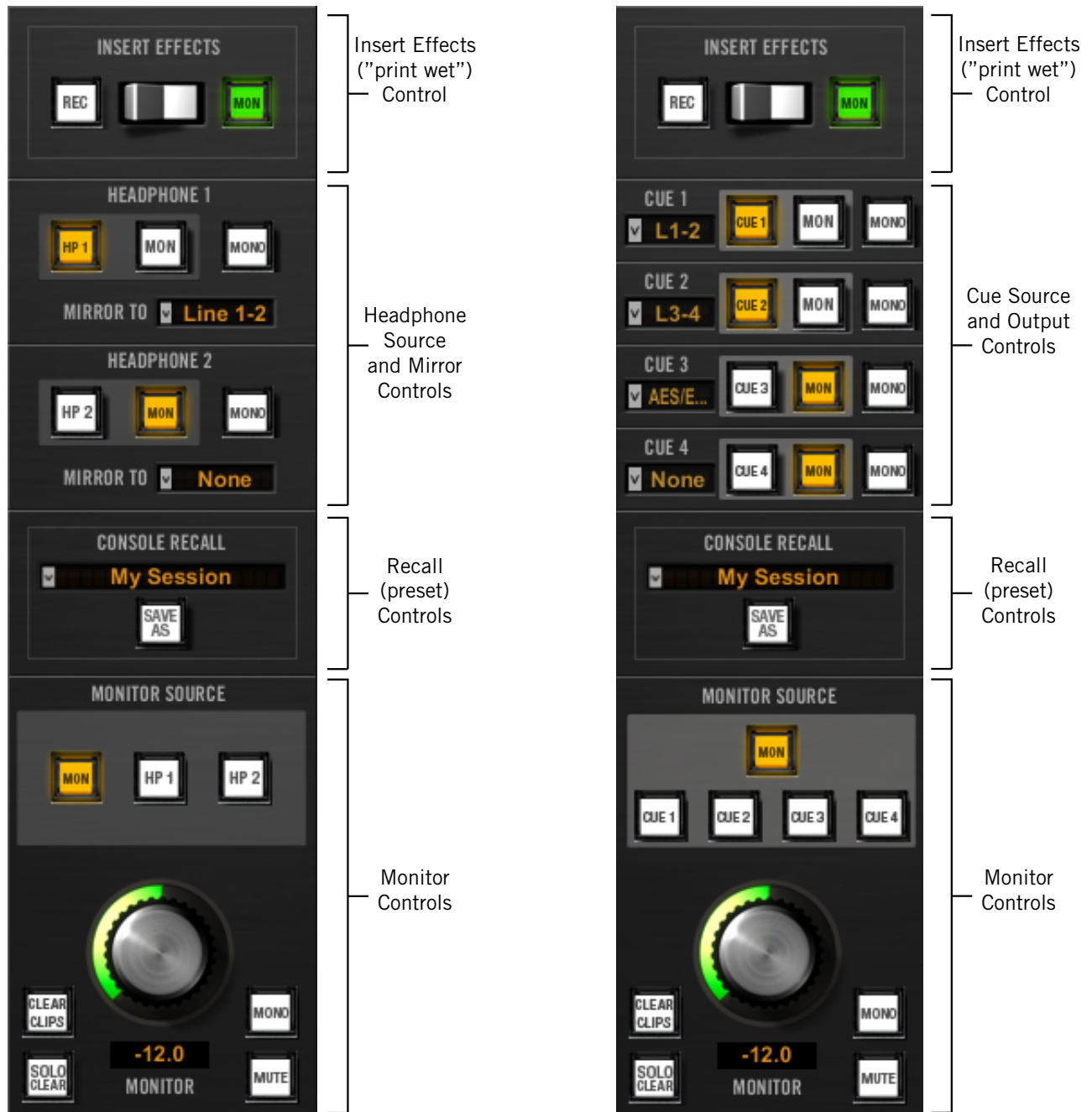

The monitor controls as they appear with Apollo (left) and Apollo 16 (right).

Insert Effects

Overview

Console's primary function is to control Apollo's input monitoring features. Using Console, Apollo's inputs can be recorded without signal processing (dry) or with Realtime UAD processing (wet) via the Insert Effects switch.

By using Console to monitor live audio, the operator can record the Realtime UAD Processing either dry or wet without any I/O buffering and the latencies associated with software monitoring via the DAW.

Important: *Unison plug-in processing in Console's INPUT insert is always routed to the DAW, regardless of the current Insert Effects setting (Unison INPUT insert processing is always recorded). See the [Unison](#) chapter for more information.*

Function of the Insert Effects Switch

The Insert Effects switch determines if the DAW records Console's inputs with or without Realtime UAD Processing, regardless of the actual wet or dry state of the monitor mix. This is accomplished by routing Console's inputs into the DAW from before the plug-in inserts (dry recording) or after the plug-in inserts (wet recording).

Note: *Recording into a DAW with or without Realtime UAD Processing via the Insert Effects switch is a global function. The function cannot be individually enabled per input.*

Record With Effects

When Record With Effects is active, Apollo's hardware input signals are processed by Console's UAD plug-in inserts before routing into the DAW.

In this mode, the post-insert (wet) state of all Console inputs with Realtime UAD Processing is routed to the DAW inputs.

Record With Effects is active when the Insert Effects REC button pulses red.

Note: *This setting is used to record "wet" with Realtime UAD Processing.*



Monitor With Effects

When Monitor With Effects is active, Apollo's hardware input signals are routed directly into the DAW before being processed by Console's UAD plug-in inserts.

In this mode, the pre-insert (dry) state of all Console inputs is routed to the DAW inputs, even if Realtime UAD Processing is occurring in the monitor mix.

Record With Effects is off when the Insert Effects MON button is green.

Note: *This setting is used to record "dry" when Realtime UAD Processing is active.*



Headphone 1 & 2 Source (Apollo)

Note: This section does not apply to Apollo 16, which does not feature headphone outputs.

Headphone Overview

Apollo has two stereo headphone outputs on its front panel. Each headphone output is individually addressable in Console, or the DAW via Apollo's device drivers.

Because their signal paths are separate from the monitor outputs, these outputs can be configured to contain unique mixes that are completely independent from other Apollo hardware outputs.

The headphone outputs mirror the stereo monitor outputs by default, but each output can be configured have its own unique mix via Console's dedicated headphone mix buses.

Any DAW outputs can also be routed into the headphone mix buses via Apollo's device drivers (see [“Virtual I/O” on page 97](#) for more info).

Headphone Source 1 & 2 (Apollo)

These buttons determine the source of the headphone bus mixes. Note that a headphone output can only use its own mix bus (or the monitor mix) as its source. For example, you can't select HP 2 as the source for HP 1, and vice versa.

HP 1, HP 2 (Apollo)

When set to HP, the headphone source is the dedicated headphone mix bus, summed with all DAW outputs that are routed to Apollo's headphone outputs (if applicable). In this mode, the mix of the this bus is determined by the Headphone Send controls in the input channel strips and the aux return strips. Console's faders, mutes, and solos are not reflected in the headphone output in HP mode (Console's headphone sends are pre-fader).



Note: When the Headphone Source is not set to MON, aux returns must be sent to the headphone mix bus (via the aux headphone sends) for the aux to be heard in the headphones.

MON (Apollo)

When set to MON, the headphone source is Console's main monitor mix, summed with all DAW buses that are routed to Apollo's monitor outs (if applicable). Console's faders, mutes and solos are reflected in the headphone output in this mode.

Headphone Mono 1, 2 (Apollo)

This button sums the left and right channels of the stereo headphone output into a monophonic signal. The headphone output is stereo when the button is white and mono when the button is yellow.

Mirror To Output (Apollo only)

The headphone outputs can be simultaneously routed (mirrored) to an additional pair of hardware outputs. To send the headphone mix bus to another output pair in addition to the front panel headphone jack, select an output pair from the “MIRROR TO” drop menu.

Note: If an output in the menu is dim and cannot be selected, the output route is already in use by another channel, aux, headphone (Apollo), or cue (Apollo 16).

Important: The headphone mirror to output route in Console overrides DAW output channels assigned to the same hardware output.

Headphone Mono 1, 2 (Apollo)

This button sums the left and right channels of the stereo headphone or line 3–4 outputs into a monophonic signal. The headphone or 3–4 output is stereo when the button is white and mono when the button is yellow.

Cue Returns (Apollo 16 only)

The four cue returns contain the summed stereo buses from the four cue sends of each Console input channel.

Cue Outputs (Apollo 16)

Each cue mix bus can be routed to any pair Apollo 16’s hardware outputs. Cue 1 and 2 outputs can also be virtually routed to DAW inputs via the device drivers to record the cue mix bus (cue 3 and 4 are available via Console only).

When multi-unit cascading, cue outputs can be routed to the outputs of the monitor unit only.

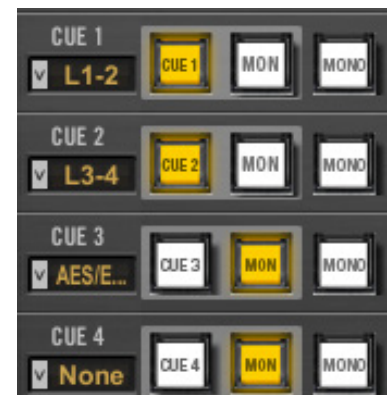

Note: Cue outputs 3 and 4 are unavailable at sample rates of 176.4 kHz and 192 kHz.

Cue Output Menu (Apollo 16)

Click the Cue Output Menu to specify a different hardware output pair for the cue mix bus.

Cue output assignments are mutually exclusive. When a cue output route is assigned, that output becomes unavailable for routing from a different cue bus. Cue mix buses cannot be merged to the same output(s).

Note: If an output in the menu is dim and cannot be selected, the output route is already in use by another input channel or cue bus.

Important: The cue output route in Console overrides DAW output channels assigned to the same hardware output.

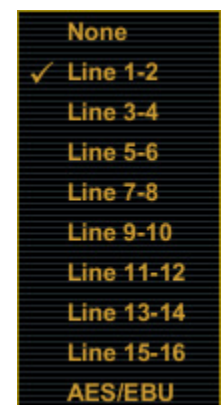

Cue Source (Apollo 16)

The cue source buttons determines the source of the cue bus mix. The cue source can be set to output the associated cue mix or the main monitor mix.

CUE (Apollo 16)

When set to CUE, the cue source is the dedicated cue mix, summed with all DAW outputs that are routed to the same cue outputs (if applicable). In this mode, the mix of the cue bus is determined by the cue send controls in the input channel strips and the aux return strips.

Console's faders, mutes, and solos are *not* reflected in the cue outputs in when CUE is selected (Console's cue sends are pre-fader).

MON (Apollo 16)

When set to MON, the cue source is Console's main monitor mix, summed with all DAW outputs that are routed to the monitor outs (if applicable). Console's faders, mutes and solos *are* reflected in the cue output in this mode.

MONO (Apollo 16)

This button sums the left and right channels of the stereo cue output into a monophonic signal. The cue output is stereo when the button is white and mono when the button is yellow.

Monitor Controls

Monitor Meters

Console's Monitor Meters are twin pin-style peak meters that display the pre-fader signal levels of Apollo's monitor mix bus. Levels displayed here reflect the state of the Monitor 1 – 2 LED meters on Apollo's front panel.



Console's Monitor Meters

Meter Source

When the monitor output signals are changed with the [Monitor Source](#) buttons, the levels displayed here reflect the changed monitor outputs source signal.

Meter Level Scale

The meter numbering represents the digital level of the monitor channel, where “0” is 0 dBFS. Both meters include a clip LED that illuminates when the level at the monitor outputs exceed 0 dBFS (when D/A converter clips). The clip LED hold time can be adjusted in the [Console Settings Panel](#).

Important: *If clipping occurs, reduce the monitor output levels by reducing levels of the channels feeding the monitor mix bus to eliminate undesirable D/A clipping distortion.*

Monitor Source

The Source buttons define which signal bus is routed to the Apollo's monitor outputs. The active monitor source is indicated by a yellow button.



The monitor source buttons with Apollo (left) and Apollo 16 (right).

Monitor

When MON is selected, the main Console mix bus is routed to the monitor outputs.

Headphone 1, 2 (Apollo)

When HP 1 or 2 is selected, the headphone bus (the mix created from HP sends on Console's inputs and/or DAW outputs assigned to the HP outputs) is routed to the monitor outputs.

***Note:** To prevent a feedback loop, HP cannot be selected when the Headphone Source is set to MON.*

Cue 1, 2, 3, 4 (Apollo 16)

When one of the cue buttons is selected, that cue bus (the mix created from cue sends on Console's inputs) is routed to the monitor outputs. To prevent a feedback loop, CUE cannot be selected when the cue source is set to MON.

***Note:** Cue outputs 3 and 4 are unavailable at sample rates of 176.4 kHz and 192 kHz.*

Monitor Global

Clear Clips

Clicking this button clears all clip indicators and peak hold indicators on all meters.

Solo Clear

Whenever Solo is engaged on any channel input, the Solo Clear button blinks yellow. Clicking the Solo Clear button deactivates the Solo function of any/all channel inputs. Clicking Solo Clear again will return all channels to their previous Solo state.

Mono

This button sums the left and right channels of the stereo monitor output into a monophonic signal. The monitor output is stereo when the button is white and mono when the button is yellow.

Monitor Mute

This button mutes Apollo's monitor outputs. The monitor outputs are muted when the button is red. This button performs the same function as pressing the MONITOR knob on Apollo's front panel.

Monitor Level

This is the master level control for Apollo's monitor outputs; it performs the same function as the MONITOR knob on Apollo's front panel.

The specific monitor output level is displayed in decibels beneath the Monitor Level control. The relative monitor output is indicated by the green LED ring surrounding the Level control, like the MONITOR knob on Apollo's front panel. When the monitor outputs are muted, the ring is red.



Session Recall

Overview

The Recall controls provide a method for managing complete Console configurations as session (preset) files. When a Console session file is saved, the current Console configuration is written to disk. When a session file is subsequently reloaded, Console is returned to the exact same configuration state, regardless of any changes to Console that were made in the interim.



Content of Session Files

Console session files contain most, but not all, Console settings. The specific parameters are listed below.

Parameters Saved in Session Files

All knob, slider, and menu values, all inserted UAD plug-ins, settings contained within the plug-ins, and settings in Console Settings window (except those listed below).

Parameters Not Saved in Session Files

All Monitor Gain, Line Output Reference Levels, Clock Source, Sample Rate, and Monitor Outputs Digital Mirror settings are global parameters that are not session-specific. These settings are in the Console Settings window.

The Unit Tab Monitor/Expander designation when multi-unit cascading is also not saved in session files.

Default Session Files Location

By default, session files are saved to, and loaded from, the user's home folder at:

- Mac: /Users/(current user)/Documents/Universal Audio/Sessions/
- Windows: C:\Users\UserName\AppData\Roaming\Universal Audio\Sessions

Although session files can be saved to (and loaded from) any location on disk, using the default location enables the most convenience because Console always uses this location for the Open/Save dialogs presented by the operating system.

***Note:** Session files must reside in the default location to appear in the sessions list within the Recall Menu.*

Session Files Suffix

Console's session files have the ".uadmix" suffix. The suffix is added to session files automatically when saving to disk; however, the suffix is not displayed in the OS file save dialog (the suffix should not be manually typed when saving a session file).

***Note:** Without the .uadmix suffix, the session files will not be visible in the "Open" dialog windows or the Recall menu, and they won't be opened when double-clicking them in the OS file system.*

Session Name

The name of the current session is displayed in the area just below the white CONSOLE RECALL text (“My Session” as shown at right is the current session name). Session names are created when the file is saved; they can also be renamed in the OS file system.



Modified Session Name

When any Console setting is changed after the session was saved, its name appears in *italics* as shown at right. This is a convenient visual reminder that the session is modified and may need to be saved for future use.

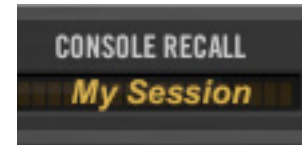

SYNC Session Name

When a DAW project containing the Console Recall plug-in is opened that has the SYNC function in the plug-in enabled, the name changes to “Sync Session” and the name is dimmed. See [SYNC](#) for related details.

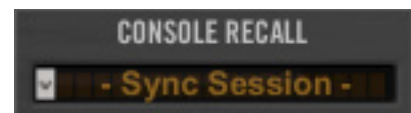

SAVE AS Button

This button opens the operating system’s standard file save dialog window so a new session file can be named and saved to disk. It performs the same function as selecting “Save As...” from the Recall menu (below) or Console’s [File Menu](#).

Recall Menu

Overview

The Recall menu contains the session file management options and lists of existing sessions.

Items in the menu are divided into three sections. File management options are in the top section, existing session files that reside on disk are listed in the center section, and cached (overwritten) sessions are listed in the bottom section.

Accessing the Recall Menu

Single-clicking the session name or the gray disclosure triangle to the left of the name displays the Recall Menu. When the menu is displayed, clicking an item in the menu chooses that item.

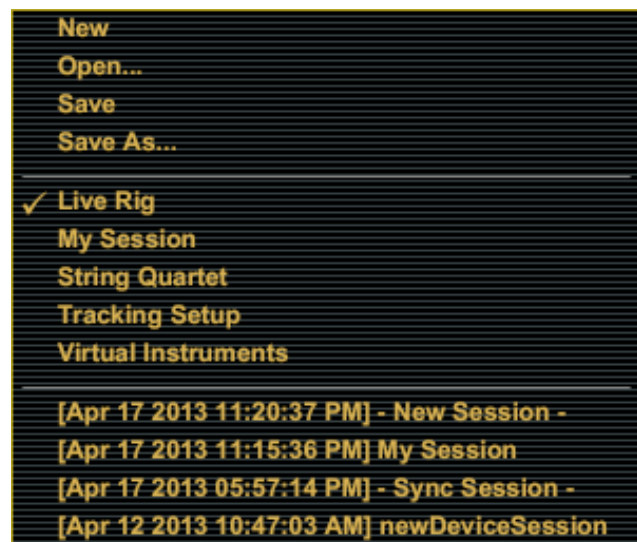

Modified Session Dialog

If the current Console session has been modified and a new Console session is loaded, a dialog window displaying the current session name in quotes appears with option buttons (the name session name in quotes does *not* appear if the session has never been saved). The behavior of the option buttons in this dialog are detailed below.

Important: This dialog does not appear when a Console session is loaded via the Console Recall plug-in's SYNC function. See [SYNC](#) for details.

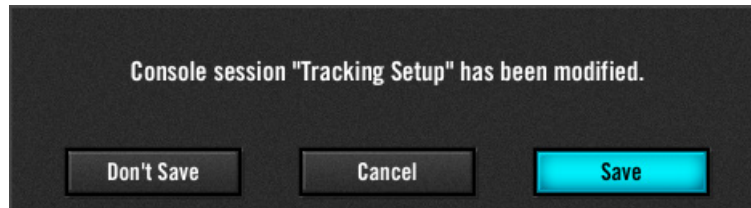

The modified session dialog

Don't Save

All modifications to the current Console session are discarded and the session is loaded.

Cancel

The current Console session remains active and the attempted Console session load is canceled.

Save

The current session is saved to disk and the session is loaded. If the session has never been saved to disk, this button displays “Save As...” which opens the file save dialog.

File Management Options

These options appear in the upper section of the Recall Menu. They perform the exact same functions as the equivalent items in the [“File Menu”](#) on page 64.

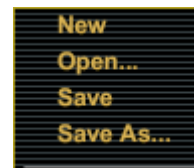

Sessions List

Existing user-created session files that reside in the default session file location are displayed in the center section of the recall menu. (The session names at right are examples only.)

Select a session from the list to load the session file. If the current session has been modified, the Modified Session Dialog appears.

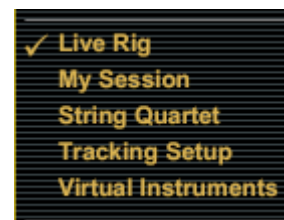

Note: Session files must reside in the [Default Session Files Location](#) and have the `.uadsession` suffix to be visible in the Recall Menu's sessions list.

Subfolders

Session files can be displayed and loaded from within subfolders. Session files in subfolders are organized in the menu with extra spacing and indentations, as shown at right.

The subfolder names are aligned more to the left and cannot be selected. Session files are indented and can be selected. Session files not within subfolders appear at the top of the list.

Note: Organizing session files within subfolders is performed within the operating system's file system.

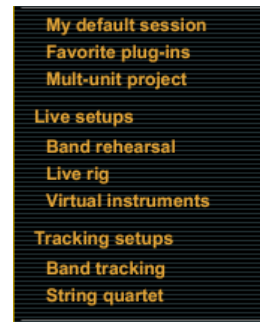

Cached Sessions

Cached sessions appear in the bottom section of the recall menu. Cached sessions are the same as session files, except they don't reside in session files on disk. Instead, these sessions are automatically created and stored in a temporary cache.



Cached sessions are automatically created by SYNC in the Console Recall plug-in

Why They Exist

When a DAW project containing the Console Recall plug-in is opened and the plug-in's SYNC function is enabled, the Console settings contained in the DAW project overwrite the current Console settings. The cached sessions are used to recover the overwritten data if desired. See [SYNC](#) for details about the feature.

When They Appear

A cached session is automatically created every time a DAW project containing the Console Recall plug-in is opened and the plug-in's SYNC function is enabled. In this scenario, the SYNC function loads the Console session contained in the DAW project, and the previously-active Console settings are moved into the cached sessions menu.

The previously-saved Console session's filename is retained in the cached session, and a timestamp is prefixed so it can be easily distinguished from other sessions. The five most-recently cached sessions appear in the list.

Console Settings Window

Settings Overview

Global parameters for Apollo and Console are configured in the Console Settings window. The Settings window has three control panels: Interface, Outputs, and Console. Controls in each of the panels are in this section.

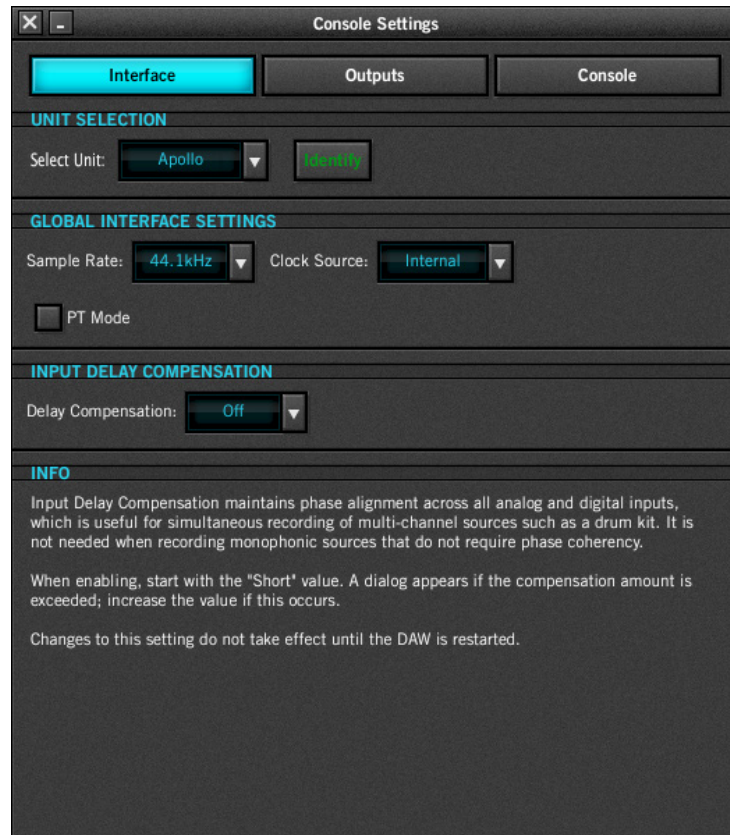

The Console Settings window

INFO box

Each panel contains an information area at the bottom of the panel. The INFO box displays informative text about the parameters in each panel when the mouse is hovered over the parameter.

Accessing the Console Settings Window

Access the Console Settings Window from the [Edit Menu](#) within the Console application (upper left of Mixer window), or:

Mac OS X

- Select Console Settings under the UA icon in the Menu Bar (upper right of screen)

Windows

- Select Console Settings from the menu after right-clicking the UA icon in the Windows System Tray (lower right of screen)

Interface Settings Panel

The Interface panel is used to configure Apollo's system-level audio interface I/O settings such as sample rate, clock source, and output reference levels. These settings are used by host applications when they are configured to use Apollo as the audio interface. Even when Console is not open, these settings are stored by the Apollo drivers and will be used by other host applications.

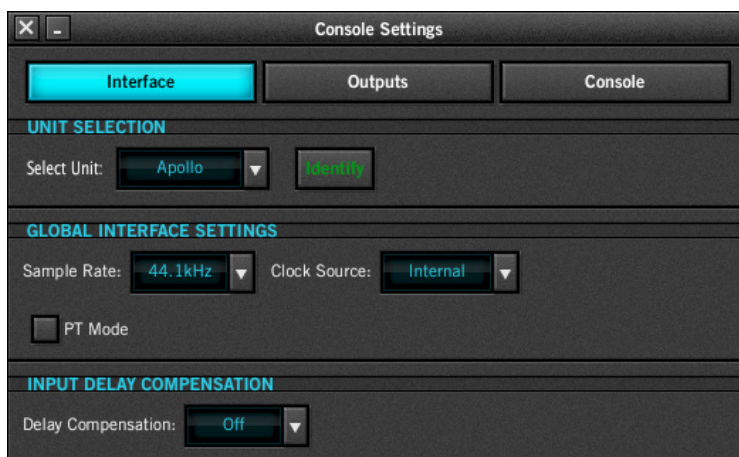

The Interface panel within the Console Settings window

Unit Selection

Tip: The Unit Selection functions can also be performed in the Console Mixer by right-clicking the Unit Tabs (at upper right of the Console Mixer window).

Select Unit

This menu specifies the unit for the Identify function (see below) when multi-unit cascading. Click the triangle to the right of the unit name to display the drop menu and select a different unit. This feature is only applicable when using a supported multi-unit configuration.

Rename Unit

The default unit name can be changed. To change the unit name: Click the unit name field, enter the new name, then click outside the field or press return on the computer keyboard.

Note: Text in this field is red when Apollo is not detected.

Identify

Clicking the Identify button will cause the currently selected unit's front panel LEDs to flash in a pattern. This identifies the unit that is currently being controlled by Console (the current unit is changed with the Select Unit menu).

Note: This button is red when Apollo is not detected.

Host Status

When the Apollo drivers are not properly communicating with the Apollo hardware, text in the Unit Selection section appears in red. Check software installation and connections if this occurs.

Global Interface Settings

Behavior and control of the Global Interface Settings depend on the environment:

Without a DAW – Sample Rate and Clock Source settings define the active sample rate and clock source for Apollo when a DAW is not used (when Console is the only host application). PT Mode has no effect when audio applications (other than Console) are not used.

With a DAW – These settings are usually changed within the DAW application’s audio preferences.

***Note:** PT Mode changes the driver I/O complement, therefore it affects all DAWs under both Mac and Windows. See [“PT Mode” on page 99](#) for details.*

Sample Rate

Defines the sample rate that will be used for Apollo A/D and D/A conversion and UAD Powered Plug-Ins processing. When using UAD Powered Plug-Ins, higher sample rates require more UAD DSP resources.

***Important:** When the Clock Source parameter is set to use any external clock source, the sample rate must be manually set to match the sample rate of the external clock.*

Clock Source

Sets the master clock source for A/D and D/A conversion. The available options are:

Apollo – Internal clock or external clock from S/PDIF, ADAT, or Word Clock.

Apollo 16 – Internal clock or external clock from AES/EBU or Word Clock.

If the Clock Source setting is not set to Internal and the external clock signal is not detected, then the text in the Clock Source display is RED (if this occurs, verify connections and external clock device settings).

***Note:** Only one device in a system can be the master clock. This setting must match the host DAW setting or audio glitches and/or distortion could occur.*

Buffer Size (Windows only)

This menu determines the audio interface hardware I/O buffer size. On Mac systems, the I/O buffer size is changed within the DAW audio preferences.

PT Mode

PT Mode facilitates Pro Tools’ Hardware Inserts feature by inserting NULL (empty) values at inputs 1 & 2 so input/output numbering within Pro Tools is aligned. This setting also optimizes Apollo’s I/O channels to accommodate the 32 I/O channels available in Pro Tools.

PT Mode only affects operation with host audio applications that can address an audio interface’s individual I/O. The setting does not affect use with Console.

See “PT Mode” on page 99 for complete details about this feature.

Important: Enabling PT Mode changes the driver I/O complement. Quit all audio applications before changing the PT Mode setting.

Input Delay Compensation

Input Delay Compensation (IDC) maintains phase alignment across Console’s analog and digital inputs when upsampled UAD plug-ins are used. See “Input Delay Compensation in Console” on page 108 for a complete explanation of this feature.

When enabling IDC, it’s usually best to start with the Short value (100 samples – the default value) to minimize latency.

A dialog will appear in Console if the compensation amount is exceeded on a channel. If this occurs, either increase the IDC value or reduce upsampled plug-ins usage on the channel to maintain phase alignment.

Note: Changes to this setting do not take effect until the DAW is quit.

Input Delay Compensation Values	
Setting Name	Extra Delay (samples)
Off	0
Short	100
Medium	200
Long	1000

Outputs Settings Panel

The Outputs panel is used to configure the global behavior of the hardware outputs.

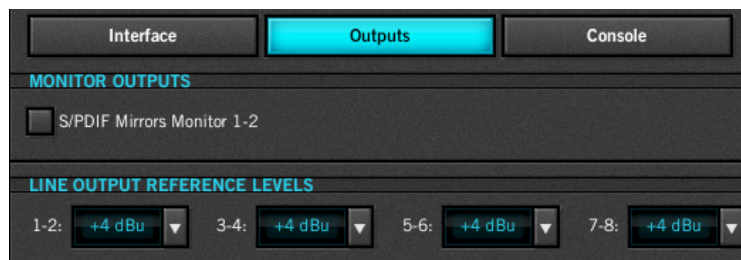

The Outputs panel within the Console Settings window

Monitor Outputs

S/PDIF Mirrors Monitor 1–2 (Apollo only)

AES/EBU Mirrors Monitor 1–2 (Apollo 16 only)

This setting configures the S/PDIF (Apollo) or AES/EBU (Apollo 16) outputs to mirror the Monitor 1 & 2 outputs. This feature can be useful when connecting to the stereo inputs of other devices with digital inputs such as a speaker system, stereo recorder, or external D/A converter.

When Mirror mode is active, the Monitor Level knob controls both the digital output level and the analog monitor output level (these digital outputs are post-fader when mirrored).

Note: When this box is checked, any DAW outputs and/or Console aux outputs that are routed to these digital ports will not be heard, because the digital ports are switched to output the monitor bus instead.

Operating Level (Apollo 16 only)

This menu switches the operating level of the monitor outputs. Available selections are 20 dBu and 14 dBu.

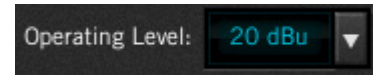

Line Output Reference Levels

These drop menus set the reference level for the line outputs. The number of menus displayed depends on the currently connected Apollo hardware (multiple units and/or Apollo 16 will display more menus). The name of unit(s) the from the [Rename Unit](#) field are reflected here to identify the outputs.

The line output reference levels can be set to -10 dBV or $+4$ dBu in adjacent pairs. The value is usually set to match the nominal input level of devices connected to these outputs (a setting of $+4$ dBu outputs a higher signal level than -10 dBV).

Note: Input reference levels for the analog line inputs are set in Console's channel input strips.

Console Settings Panel

The Console panel is used to configure the global behavior of the Console application.

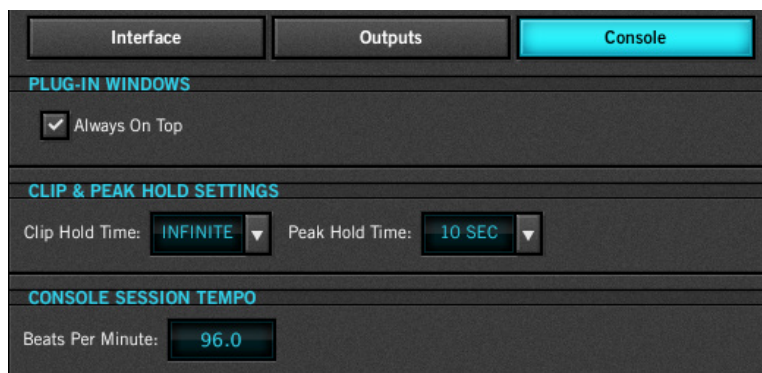

The Console panel within the Console Settings window

Always On Top

Normally, a UAD plug-in window can be covered by the Console Mixer window when Console is the foreground application.

When this box is checked, UAD plug-in windows always float on top of the Console Mixer and Settings windows (when Console is the foreground application), so they can always be seen and adjusted.

Note: This setting only affects UAD plug-in window behavior within Console; it does not apply to UAD plug-ins when they are used in other host applications.

Clip & Peak Hold Settings

Tip: The Clip and Peak indicators can be cleared at any time with the [Clear Clips](#) button.

Clip Hold Time

This drop menu sets the duration that the red signal clip indicators in the input, send, and monitor meters are displayed before turning off. The available values are None, 1 second, 3 seconds (default), 5 seconds, 10 seconds, or Infinite.

Peak Hold Time

This drop menu sets the duration that the signal peak indicators in the input and send meters are displayed before turning off. The available values are None, 1 second, 3 seconds (default), 5 seconds, and 10 seconds.

Console Session Tempo

This setting determines the tempo, in Beats Per Minute (BPM), for UAD plug-ins within Console that are set to use Tempo Sync. The value is saved within Console session files, and also within DAW project files when the Console Recall plug-in is used the DAW project.

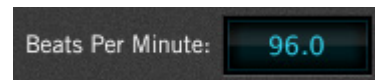

To change the tempo, first click the field, then type a new value and press return. For details about how to use the Tempo Sync feature with UAD plug-ins, see the UAD System Manual.

Note: The default tempo of new Console session files is 120 beats per minute.

Window Title Bar

The Window Title Bar is the topmost strip in the Console Mixer window, as shown in [“Control Groups”](#) on page 23.



Quit – Quits the Console application. Console’s current settings are saved to disk when quit; when Console is subsequently launched, those settings are uploaded to Apollo. 

Minimize – Reduces the window to the Dock (Mac) or Task Bar (Windows). The window can be restored by clicking the minimized window, or any [“Accessing Console”](#) method detailed on page 22. 

Fit – Expands the Console Mixer window to the maximum size available on display monitor that the window currently resides on. 

Unit Tab

The Unit Tab is located at the upper right of the Console Mixer window, above the monitor level meters and beneath the window title bar. The Unit Tab performs the following functions:

- Selects, identifies, and/or renames the current unit(s)
- Indicates the status of the host computer connection
- Designates the monitor and expander units when multi-unit cascading (Apollo & Apollo 16 only)



All functions except monitor/expander re-designation perform the exact same functions as the equivalent controls in the Interface Settings panel, for convenient access to these functions.

Appearance

A single tab appears when a single unit is connected; a second tab appears when multi-unit cascading (Apollo & Apollo 16 only), as shown below.



Select Unit

To select a different unit when multiple units are connected, single-click its tab.

Identify and Rename Menu

To access the Identify and Rename functions, right-click the tab to display the Identify and Rename menu.



Host Status

The Host Status indicator is the colored dot at the upper right of the tab. The dot is green when the software and hardware are communicating properly. The dot is red when the hardware is not recognized by the software.

Apollo & Apollo 16 only: The indicator reflects the status of the UAD Link (Apollo) and Host (Apollo 16) LEDs on the front panel of the hardware.



The color of the dot indicates the status of the host computer connection

Application Menus

The Applications Menus are contained within the second strip from the top in the Console Mixer window (see [“Control Groups” on page 23](#)).

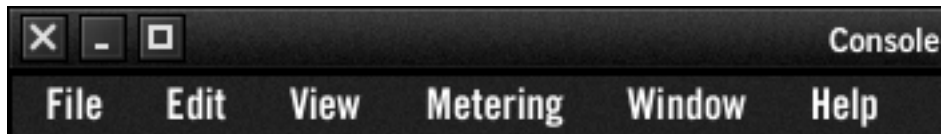

Console's Application Menus

File Menu

File	Edit	View	Metering	Window
New Session				command + N
Open Session...				command + O
Save Session				command + S
Save Session As...				shift + command + S

Console's File Menu contents

New Session

Creates a new Console session with default settings (default settings cannot be changed). If the current session has been modified, the Modified Session Dialog appears.

Open Session...

Opens the operating system's standard "Open File" dialog window for loading existing session files from disk. Session files can also be opened by double-clicking .uadmix files from within the OS's file system.

Caution: All current Console settings are overwritten (and lost, if not previously saved) when Console sessions are loaded.

Save Session

If a session file was previously saved, selecting this option writes the current settings to the file with the same name, overwriting the previously saved file. If the current session has never been saved, the operating system's standard "Save File" dialog window appears so a new session file can be named and saved to disk.

Save Session As...

This option opens the operating system's standard "Save File" dialog window so a new session file can be named and saved to disk.

Important: Session settings will not be saved if the "/" (forward slash) or "?" (question mark) characters are in the filename. Avoid these characters when saving session files.

Edit Menu



Console's Edit Menu contents

Undo

When a parameter value in the Console Mixer window is edited, the change can be reverted with the Undo command. Only the last edit performed can be reverted with this command.

Redo

When the Undo function (above) is executed, the original edit can be restored with the Redo command. Only the last Undo performed can be restored with this command.

Note: *Undo/Redo are unavailable for plug-in instantiations and parameter edits within plug-in windows, and also when using key modifiers to link/unlink channel parameters (including linear and discrete controls).*

Settings

Selecting this option opens the Console Settings window, where various global parameters are configured. See [“Console Settings Window” on page 57](#) for details about the window.

View Menu

The View Menu provides a convenient way to hide channel strips of a particular type from view. This feature reduces screen space required by Console and/or the need for scrolling (if the window size is reduced), or when particular input types are not being used.

Note: *Availability of items in this menu reflect the hardware and settings available with each Apollo model.*

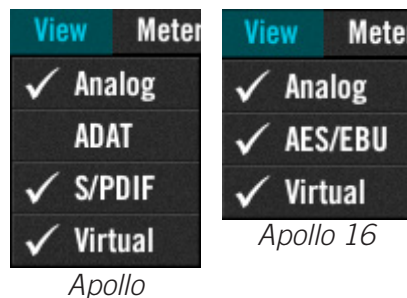

A check mark indicates channel input strips of that type (Analog, Digital, Virtual) are displayed. Choose an item in the menu to un-check the item. Choose the item again to re-check it and restore the inputs for viewing.

Note: *All input channels remain active even if they are hidden from view.*

Metering Menu

Pre-Fader

When set to Pre-Fader, an input's Channel Meter indicates the level at the Apollo input, regardless of the Channel Fader setting, and changing the fader level will not affect the Channel Meter.

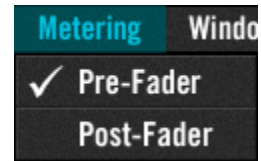

Post-Fader

When set to Post-Fader, changing an input's Channel Fader will affect the Channel Meter.

Note: *The Metering Menu affects the Channel Meters of Console's channel inputs only. It does not affect the Aux Meters or the Monitor Meters.*

Window Menu



Console's Window Menu contents

Show Mixer Window

This item brings the Console Mixer window to the foreground.

Show Plug-In Editor Windows

This item brings all open UAD plug-in windows to the foreground (if any).

Note: *This item applies only to UAD plug-ins used within Console, not those used within a DAW.*

Close All Plug-In Editor Windows

Closes all open UAD plug-in windows (if any).

Help Menu

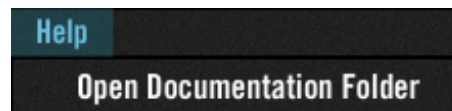

Console's Help Menu contents

Open Documentation Folder

This item opens the folder containing all the Apollo product user documentation files. Consult the documentation when you need specific operational information.

After opening the folder, double-click a documentation file to open it.

***Tip:** Use the search function within the PDF reader application to quickly find information about a particular topic.*

Contents of the documentation folder:

- Apollo Hardware Manuals (Apollo, Apollo 16)
- Apollo Software Manual
- UAD System Manual
- UAD Plug-Ins Manual
- Direct Developer (3rd-party) plug-in manuals

Chapter 4: Console Recall Plug-In

Console Recall Overview

Console Recall is a DAW plug-in supplied in VST, RTAS, AAX 64, and Audio Units formats. It is instantiated and used within any VST/RTAS/AAX/AU host DAW like any other plug-in.

The primary function of the Console Recall plug-in is to store the Console application's current settings within the DAW via the **SYNC** (synchronize) function. It can also be used to view and adjust Apollo's monitor output level, mono, and mute states without having to leave the DAW.

Note: The Console Recall plug-in is not required to use the Apollo interface hardware, the Console application, or a DAW.



The Console Recall plug-in window

How To Use Console Recall

To use Console Recall, simply place **one** instance of the plug-in into any insert slot in the DAW project.

Important: Do not insert more than one occurrence of the Console Recall plug-in within any single DAW project. Doing so could cause unpredictable results.

Because the plug-in does not process audio in any way, the insert location isn't critical. Although it can be placed on any audio track, virtual instrument track, aux bus, output, etc, we recommend placing it on the master output for consistency since projects usually contain an output channel.

Upon instantiation, the plug-in's Monitor Level, Mono, and Mute controls mirror the equivalent controls in the Console application. Enabling **SYNC** causes the current Console settings to be stored within the DAW project. See "**SYNC**" on page 70 for details about this feature.

Console Recall Controls

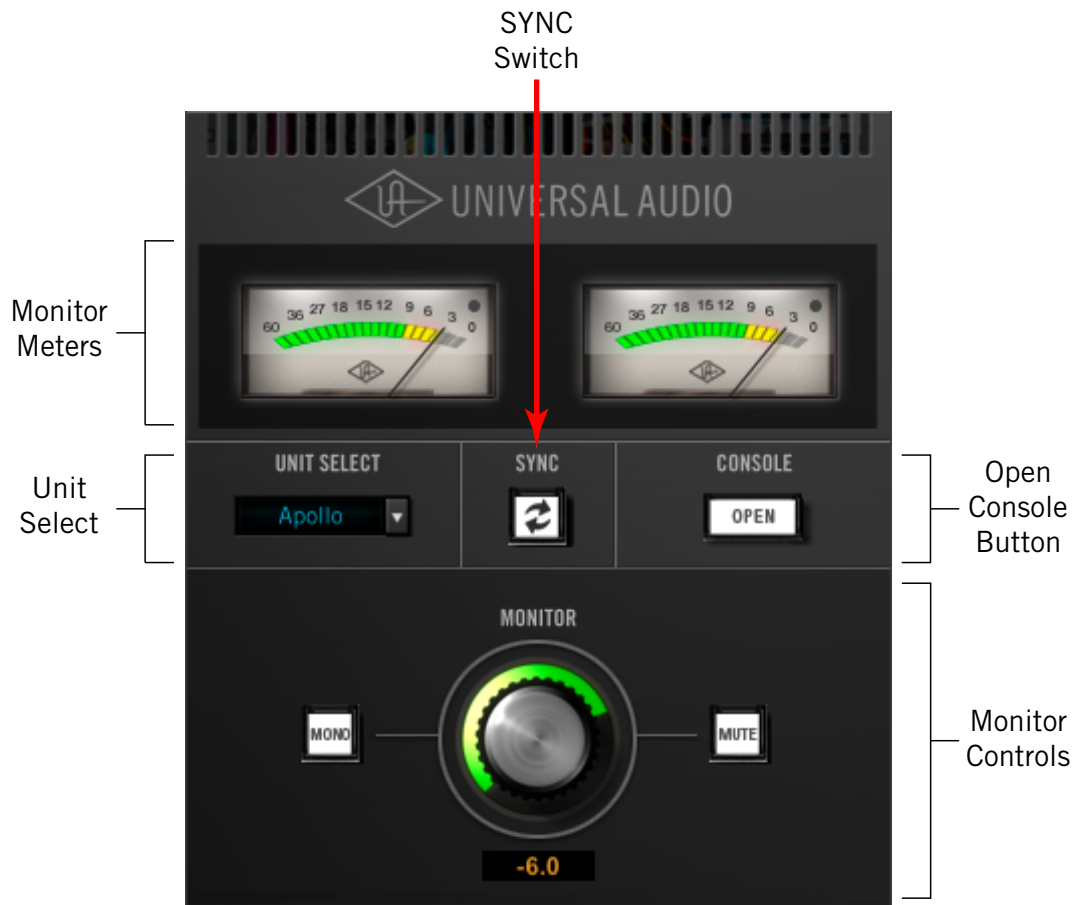

Console Recall plug-In controls layout

Most Console Recall plug-in controls are duplicates of those found in the Console application. The exceptions are the [SYNC](#) button, which is detailed beginning on [page 70](#), and the OPEN CONSOLE button, which opens the Console Mixer window.

Because the exact same control descriptions in the Console application apply to the Console Recall plug-in controls, please refer to the Console application chapter for descriptions of the duplicated controls.

Control Groupings

The diagram above illustrates the control groupings in Console Recall. These are the same groupings detailed in the Console chapter; click the hyperlinks below to jump to that section.

- **Monitor Meters** – Refer to [page 51](#)
- **Monitor Controls** – Refer to [page 50](#)
- **Unit Select** – Refer to [page 58](#)

SYNC

The Console Recall plug-in has a button called SYNC (synchronize) that is not present in the Console application. When a DAW project containing Console Recall is saved and SYNC is active, the current state of the Console application is stored within the Console Recall plug-in.

Since plug-in settings are saved within DAW project files, using SYNC enables Console's current state to be stored within the DAW project file without saving or loading Console sessions presets via the Console's [Session Recall](#) functions.

When the DAW project file is subsequently reloaded, Console is automatically restored to the previous settings state, regardless of any changes to Console or Apollo that were made in the interim.

This feature ensures the DAW project will sound exactly the same when reloaded at a later date, even if Console contains customized settings that might affect the audio, such as send mixes, signal routings, and/or Realtime UAD Processing.

Enabling SYNC

When Console Recall is first loaded, SYNC is disabled. The function is inactive when the button is white, and enabled when the button is yellow.

Enabling SYNC does not change the Console settings; SYNC doesn't do anything until the DAW project file is saved and subsequently reloaded.

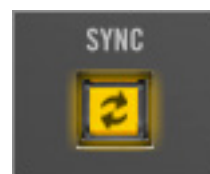

SYNC enabled

Important: SYNC saves the Console settings within the DAW file, not the Console application. Therefore the DAW project file must be saved to disk to retain the Console settings in the project.

Effect on Recall Menu in Console

When a DAW project is loaded that contains the Console Recall plug-in with SYNC enabled, the [Session Name](#) in the Console application displays "Sync Session" and the display is dimmed. See "[Session Recall](#)" on page 53 for related details.

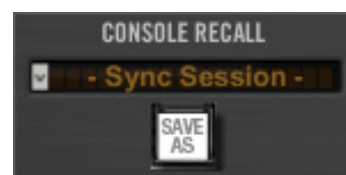

Loading Synchronized DAW Projects

If SYNC was enabled when a DAW project file containing Console Recall was saved, then loading that DAW project will load the Console settings saved in the plug-in, and the Console settings that were active before the DAW project was loaded is overwritten. However, the Console settings that were active before the DAW project was loaded can be easily recovered if desired using the [Cached Sessions](#) in the [Recall Menu](#) within the Console Application. See "[Recall Menu](#)" on page 54 for details.

If SYNC was disabled when a DAW project file containing Console Recall was saved, then loading that project will *not* change the Console settings that were active before the DAW project was loaded.

Session State Parameter

The Console Recall plug-in has a parameter called “Session State” that is exposed for DAW automation but is not in the plug-in interface. Session State ensures all changes to Console settings and the DAW session are captured by the Console Recall plug-in. If something related to Session State appears in the DAW, it’s best to just ignore it.

Important: *To ensure proper functionality when SYNC is enabled in Console Recall, do not create or edit DAW automations with the Session State parameter.*



Chapter 5: Unison

What is Unison?



Unison is an exclusive analog/digital integration system that's built into every Apollo microphone preamplifier. It's the first and only way to truly emulate classic analog mic preamp behaviors in an audio interface.

Unison is an audio processing breakthrough that starts right at the source, the input stage, allowing Apollo's mic preamps to sound and behave like the world's most sought-after tube and solid state preamps — including their all-important impedance, gain stage “sweet spots,” and component-level circuit behaviors.

Apollo's mic preamps are designed for high resolution, ultra-transparent translation from microphone to converter. This clean hardware design is the foundation for adding software color with UAD plug-in processing.

Unison-enabled UAD preamp plug-ins reconfigure the physical input impedance, gain staging response, and other parameters of Apollo's mic preamp hardware to match the emulated preamp's hardware design characteristics.

Because the hardware and software are intricately unified, Unison provides continuous, realtime, bi-directional control and interplay between Apollo's physical mic preamp controls and the software settings in the Unison plug-in interface.

Controls on Apollo's front panel dynamically adjust the Unison plug-in's parameters to match the target preamp behavior. Correspondingly, changing a setting in the Unison plug-in interface will modify Apollo's front panel settings.

Because Unison can be active on more than one mic channel, a complement of premium mic preamps is available concurrently.



Unison is enabled by loading a UAD preamp or pedal plug-in into Console's special INPUT insert slots

Unison Features

Unison technology enables these Apollo features, all with Realtime UAD Processing:

- **Alternate microphone preamplifier sound** – Apollo’s ultra-transparent mic preamps inherit all the unique sonic and input characteristics of the emulated hardware preamp, including the mic, line, and Hi-Z inputs.
- **Realistic tandem control** – Unison facilitates seamless interactive control of Unison preamp plug-in settings using Apollo’s digitally-controlled hardware and/or the plug-in interface. All equivalent preamp controls (gain, pad, polarity, etc) are mirrored and bi-directional. The preamp controls respond to adjustments with precisely the same interplay behavior as the emulated hardware, including gain levels and clipping points.
- **Hardware input impedance** – All Apollo mic preamps feature variable input impedance in analog hardware that can be physically switched by Unison plug-ins for physical, microphone-to-preamp resistive interaction. This impedance switching enables Apollo’s preamps to physically match the emulated unit’s input impedance, which can significantly impact the sound of a microphone. Because the electrical loading occurs on input, prior to A/D conversion, the realism is faithful to the original target hardware preamp.
- **Tactile gain staging** – Apollo’s front panel preamp knob can independently adjust all gain and level parameters available within the Unison plug-in via [Gain Stage Mode](#). The gain stage being adjusted can be remotely switched via Apollo, so multiple gain levels and their associated colorations can be tuned from the hardware knob for precise physical tactile control, all without using the Unison plug-in’s software interface.

Unison Plug-Ins

Note: In all descriptive text, “Unison plug-in” is defined as any Unison-enabled UAD preamp or UAD pedal plug-in.

Unison-enabled UAD preamplifier and guitar pedal plug-ins are uniquely coded for Unison integration. Only UAD preamp and pedal plug-ins that are Unison-enabled can be loaded in Console’s [Unison INPUT Inserts](#). The available Unison plug-ins are listed in the table below.

Unison-Enabled UAD Plug-Ins	
Unison Preamp Plug-Ins	Unison Pedal Plug-Ins
<ul style="list-style-type: none">• API Vision Channel Strip• Neve 1073 Preamp & EQ• Neve 88RS Channel Strip• UA 610-A Tube Preamp & EQ• UA 610-B Tube Preamp & EQ	<ul style="list-style-type: none">• Bermuda Triangle• Ibanez Tube Screamer TS808• Raw Distortion

Unison plug-ins that can be placed in Console’s INPUT insert slots

Activating Unison

Unison technology is activated when a Unison plug-in is loaded in the special INPUT insert slots within Apollo's Console application. Console INPUT inserts are only available on channels that have preamplifiers. Preamps are available on channels 1 – 4 with Apollo.



Note: *Unison is unavailable with Apollo 16, which does not feature preamplifiers.*

Unison plug-ins in standard insert slots

Unison plug-ins can be loaded and used in any standard insert slots available on all Console input channels and/or within a DAW via VST/AU/RTAS/AAX 64 (like any UAD plug-in). However, there is no physical or electrical hardware interaction in standard insert slots, so Unison plug-ins operate like other (non-Unison) UAD plug-ins in this configuration.

Important: *Unison features are available only when Unison-enabled UAD preamp or pedal plug-ins are loaded within Console in the INPUT insert slots.*

Unison INPUT Inserts

To activate Unison for Apollo preamp inputs, insert a Unison plug-in into Console's INPUT insert (located between the preamp controls and the standard insert slots) using the same methods as other insert slots. Unison can be active on more than one preamp channel concurrently.

Important: *Unison processing in Console's INPUT insert is always active on the channel's input signal, regardless of any subsequent channel routing options (Console Flex Routing, DAW I/O, etc). Therefore Unison INPUT processing is always recorded in the DAW, even if Console's Insert Effects switch is set to MON.*



Unique Behavior of the INPUT Inserts

Console's INPUT insert slots have some operational differences compared to standard insert slots, as described below.

Available UAD plug-ins

Only Unison plug-ins are available for selection from Console's INPUT insert menu (non-Unison plug-ins are not visible in the menu). Additionally, Unison pedal plug-ins are available on Hi-Z inputs only.

Note: All available Unison plug-ins are installed during the normal UAD Powered Plug-Ins software installation process (they are not separately installed).



Linked insert enable and plug-in enable controls

Console's INPUT insert enable/disable button and the Unison plug-in's on/off switch in the plug-in interface are linked. Changing either on/off setting will also change the other setting.



INPUT insert menu options

The INPUT insert menu options are different from the standard inserts menu. Some options are unavailable to accommodate the unique functionality of the INPUT insert.

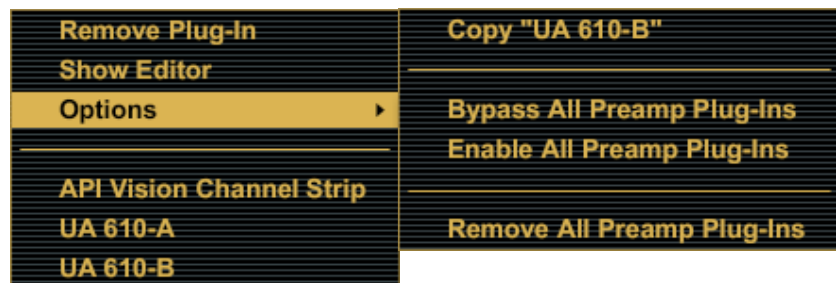

Disabled Unison plug-ins

When a Unison plug-in is unintentionally disabled (for example, when UAD-2 DSP resources are exceeded upon insertion), the red DISABLED text does not appear in the UAD Toolbar as it does with non-Unison plug-ins. However, in this situation (unlike standard UAD plug-ins) the following indications do occur:

- The power switch within the Unison plug-in window is switched off
- The insert slot's enable button is switched off
- Apollo's front panel preamp gain level indicator color reverts to green.

Note: The above functions can be re-enabled after adequate UAD resources are made available.

Controlling Unison Plug-Ins with Apollo

When a Unison plug-in is inserted in Console's INPUT insert slot, Apollo's front panel preamp controls and the Unison plug-in's equivalent preamp controls are mirrored. Adjusting Apollo's front panel preamp controls will adjust the Unison plug-in's preamp controls, and vice versa.

Apollo Front Panel Indication

Unison Active

When a Unison plug-in is inserted in a Console channel's INPUT slot *and* Apollo's front panel channel select function is set to the same channel, the color of Apollo's front panel preamp gain level indicator (the LED ring around the knob) is orange instead of green.

***Note:** Apollo's front panel channel selection indicator must match the Unison-enabled channel to see the front panel Unison indication.*

The orange-colored ring indicates that the currently selected preamp channel is using a Unison plug-in within Console, and that Apollo's front panel knob is controlling the first gain stage of the preamp plug-in (with pedal plug-ins, the knob is controlling the primary effect parameter, e.g., distortion).



Apollo's front panel preamp knob during normal operation (left) and when a Unison plug-in is inserted in Console's INPUT insert slot of Apollo's selected channel (right)

Additional Gain Stages

More than one gain parameter within the Unison plug-in can be adjusted using Apollo's front panel knob by activating Gain Stage Mode. When Gain Stage Mode is active, the color of Apollo's gain level indicator, and the target parameter within the Unison plug-in's interface, changes depending on which parameter is currently being controlled by the knob, and the parameter being controlled can be navigated remotely by pushing the knob's switch. See [Gain Stage Mode](#) for details.

Plug-In Parameters

Unison plug-ins may contain parameters that are unavailable for hardware control via Apollo. For example, the UA 610-B has EQ settings, but there are no EQ controls on Apollo's hardware. To adjust these extra parameters, the Unison plug-in interface must be used.

Console Indications

Gain Level Indicator

The color of Console's preamp gain level indicator (the colored ring around the gain knob), and the channel selection dot on the gain knob, is orange instead of green when Unison is active in the channel.



If the Unison plug-in is inactive (either via the INPUT insert disable button or the power switch in the plug-in interface), the color reverts to green.

Note: Console's preamp gain control only adjusts the first gain stage of any Unison preamp plug-in, even when Apollo is in Gain Stage Mode.

Gain Level Display

The preamp gain level display (the gain value readout under the knob) always shows the current value of the main parameter within the Unison plug-in. Additionally, the display is adapted to the parameter value and range of the first gain stage within the plug-in.



For example, when the UA 610-A Tube Preamp plug-in is in the INPUT insert, this field displays either "Hi" or "Low" because these are the only two values available in the first gain stage of this plug-in.

Note: This display shows "---" if the Apollo hardware is not detected when a Unison plug-in is in the INPUT insert and the insert is not disabled.

Front Panel Channel Selection (Apollo)

Level Knob Switch

In addition to the rotary control, Apollo's front panel preamp level knob has a switch function when the knob is pressed. The function of this switch varies depending on the active mode (either Channel Select Mode or Gain Stage Mode), as described below.

Apollo Channel Select Mode (standard operation)

Channel selection determines which input channel can be adjusted with Apollo's front panel preamp controls. This is the standard behavior when a channel is not in Unison mode; front panel channel selection is not related to Unison functionality.

***Note:** Standard channel selection is also explained in the hardware manual for each Apollo model (the channel selection methods are used without Unison).*

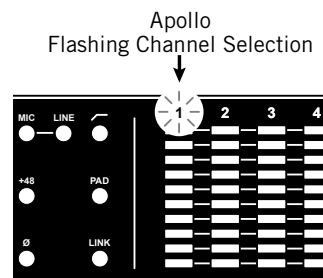

Pressing the Preamp knob cycles through Apollo's selected preamp channel (1, 2, 3, 4, repeat). A channel is selected for adjustment when its channel select indicator LED (located above the channel 1, 2, 3, 4 input meters) is lit. If stereo linking is active, the stereo pair(s) LEDs are lit.

Gain Stage Select (Unison operation only)

When the currently selected Apollo channel is in Gain Stage Mode, pushing the level knob changes the Unison plug-in's parameter that is being controlled.

The color of Apollo's front panel preamp gain level indicator (the LED ring around the knob) changes to reflect the gain stage being controlled, and the gain stage is also indicated by the matching color of the indicator dot within the Unison plug-in's interface. For complete details, see [Gain Stage Mode](#).

Gain Stage Mode

Unison plug-ins have either two or three gain parameters. By activating Gain Stage Mode, each of these preamp plug-in gain stages can be independently adjusted using Apollo's front panel gain knob.

Note: *Gain Stage Mode can only be active on one preamp channel at a time.*

Initially, when Unison is activated (before entering Gain Stage Mode), Apollo's gain knob controls the first gain parameter within the Unison plug-in. However, when Gain Stage Mode is active, pressing Apollo's front panel preamp knob cycles through the available gain parameters in the plug-in.

Activating Gain Stage Mode

To enable Apollo's Gain Stage Mode when using a Unison plug-in:

1. In Console, confirm a Unison plug-in is inserted in the INPUT slot of the Apollo preamp channel to be controlled.
2. On Apollo's front panel, select the preamp channel to be controlled using the standard method for your hardware model (for methods, see [page 77](#)).
3. Press AND HOLD Apollo's front panel preamp level knob for at least two seconds.

The state of Gain Stage Mode is indicated on Apollo and in the Unison plug-in, as detailed below.

Gain Stage Mode – Apollo Panel Indication

Apollo's panel channel selection number indicator LED (above its input meter) flashes when Gain Stage Mode is active for the currently selected preamp channel, as shown at right.

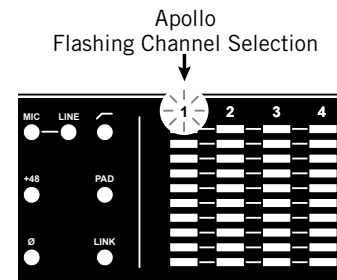

Gain Stage Mode – Unison Plug-In Indication



A colored dot appears within the Unison plug-in interface on the target parameter being controlled, as shown at left.

See [Gain Stage Colors](#) for related information.

Deactivating Gain Stage Mode

Gain Stage Mode can be deactivated with any of these methods:

- Press and hold Apollo's front panel gain level knob for at least two seconds
- Disable the Unison plug-in via Console's INPUT insert enable/disable button
- Disable the Unison plug-in via the on/off parameter within the plug-in interface
- Remove the Unison plug-in from Console's INPUT insert

When Gain Stage Mode is deactivated, the following changes occur:

1. The gain stage select function (pushing the gain level knob) reverts to the channel select function
2. The channel selection indicator on Apollo's front panel stops flashing
3. If a gain stage other than the first gain stage was being controlled, Apollo's gain level knob reverts to control of the first gain stage of the Unison plug-in, and the level indicator color reverts to orange.

Controlling Individual Gain Stages

Selecting Gain Parameters For Control

When the currently selected Unison plug-in channel is in Gain Stage Mode (when its [channel selection indicator is flashing](#)), push Apollo's gain level knob to cycle through the available gain parameters within the Unison plug-in.

Note: Unlike Apollo's front panel knob, Console's preamp gain control only adjusts the first gain stage of any Unison plug-in when Apollo is in Gain Stage Mode. To adjust other gain stages from within Console, use Apollo's gain knob or the Unison plug-in interface.

Gain Stage Colors

The gain stage being controlled is indicated by unique, [matching indicator colors](#) on Apollo's front panel and within the Unison plug-in's interface.

The color of the gain level indicator on Apollo's front panel (the LED ring around the knob) changes with each gain stage, and the matching color dot within the Unison plug-in's interface moves to the target gain parameter being controlled.

The gain stages available for control, and their associated colors, are:

- **Orange** – Gain stage one; the Gain parameter
- **Amber** – Gain stage two; the Level parameter
- **Green** – Gain stage three, the clean (non-modeled) output control

Matching Gain Stage Indicators

In Gain Stage Mode, Apollo's preamp level indicator (the LED ring around the knob) matches the colored dot on the target gain parameter in the Unison plug-in's interface, as shown below. The hardware and software controls are mirrored and the gain stage can be adjusted using either control.



The color of Apollo's preamp gain level indicator changes to reflect the gain stage being controlled

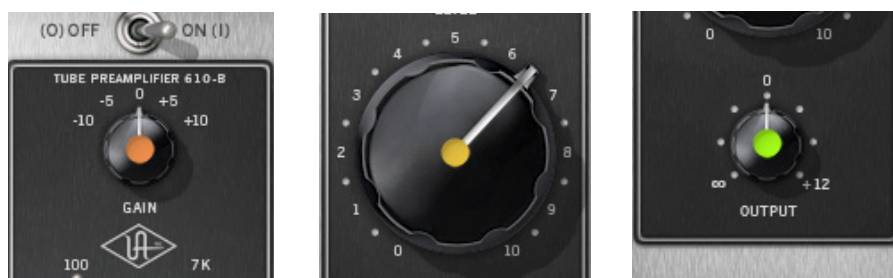

The matching color dot on the parameter in the Unison plug-in interface indicates which gain stage is being controlled by Apollo's front panel preamp knob

Available Gain Stages

Unison plug-ins have up to three gain stage parameters. With Unison plug-ins that contain two gain parameters, only the available gain parameters are cycled and controlled in Gain Stage Mode.

Note: For details about the unique gain stage parameters available within individual Unison plug-in titles, refer to the *UAD Plug-Ins Manual*.

Unison Load/Save Behaviors

Caution: Apollo hardware preamp settings may change when Console sessions are loaded.

Loading Unison Plug-In Settings

When Unison plug-in settings are loaded in Console, the effect upon the currently active Unison plug-in settings varies depending on how the settings are loaded. It's important to understand the distinction, because critical preamp settings can be affected.

Note: When Unison plug-ins are used in [Console's standard inserts and/or within a DAW](#), this section does not apply. Settings load behavior outside of the INPUT insert is like all other (non-Unison) UAD plug-ins.

There are two ways Unison (and non-Unison) plug-in settings can be loaded in Console:

- **Plug-In Presets** – UAD Presets are loaded whenever a UAD plug-in is inserted (the default preset loads). Presets can be loaded from disk files via the UAD Toolbar. Preset files are used to save & load all settings of individual plug-in titles.
- **Console Sessions** – Console sessions are loaded from disk via the Console Recall menu, the Console Recall plug-in in a DAW, or by double-clicking Console files on disk. Console sessions are complete Apollo configurations, containing all hardware and plug-in settings (i.e., Console sessions are Console presets).

Loading Presets: Hardware settings are inherited

When a Unison plug-in is loaded in the INPUT insert and a preset is loaded into the plug-in, the plug-in inherits the current equivalent hardware settings of the Apollo preamp, if those settings are available in the plug-in.

In simpler terms, Apollo's preamp settings always override a Unison plug-in's settings when a preset is loaded or the plug-in is inserted. This is done to prevent the plug-in's settings from switching the hardware to values that could cause extreme level changes and/or other unwanted circuit changes such as +48V phantom power.

For example, if the PAD is ON in the Apollo preamp, when the Unison preset is loaded, the pad setting in the plug-in is enabled to prevent unexpected level increases.

Loading Sessions: Hardware settings are overridden

When a Console session is loaded (via Console Recall menu, DAW sessions containing the Console Recall plug-in, or double-clicking Console files on disk), **ALL Console settings are overridden (changed) by the saved session, INCLUDING ALL APOLLO HARDWARE INPUT SETTINGS.**

In simpler terms, Console sessions always override Apollo's preamp settings, even if potentially harmful preamp settings are contained in the session file. This is done because the very concept of Console session recall is to reproduce all settings in the session.

For example, if the PAD is OFF in the Apollo preamp, when the Console session is loaded, the pad setting in the plug-in is disabled and sensitive equipment could be affected, such as speakers (level increases) and/or ribbon mics (phantom power).

Unison Operation Notes

The operating notes in this section only apply to Unison functionality (when Unison plug-ins are inserted in Console's INPUT slots).

The notes do NOT apply to Unison plug-ins that are used in Console's standard insert slots, nor via VST/AU/RTAS/AAX within a DAW, even when a Unison plug-in title is used. In this scenario, Unison plug-ins function the same as all standard (non-Unison) UAD plug-in titles and there is no physical or electrical hardware interaction.

Important: *Unison functionality is available only when Unison-enabled UAD pre-amp plug-ins are loaded within Console in the INPUT insert slots.*

- INPUT insert processing is always recorded in the DAW (regardless of the current [Insert Effects](#) setting) because Unison plug-ins process the physical inputs.
- A microphone, line input, or Hi-Z instrument source must be attached to the Apollo input channel for Unison plug-in processing in the INPUT insert to be audible.
- Apollo's hardware preamp controls remain active even if the Unison plug-in is disabled.
- Because Apollo's front panel preamp controls are always current and inherited by the Unison plug-in, changes made to a Unison plug-in when the plug-in is bypassed are not retained when the plug-in is reactivated.
- A Unison plug-in's modeled behaviors and parameter ranges are used by the hardware controls whenever possible, even if the attribute is different than Apollo's stock preamps. For example, if the Unison plug-in has a 15 dB pad, then Apollo's front panel PAD button value will use the Unison plug-in's 15 dB value instead of Apollo's stock 20 dB value.
- Default gain levels when a Unison plug-in is inserted can vary from Apollo's default (non-Unison) preamp levels, and also between various Unison plug-in titles. This is a by-product of accurate preamp modeling. Because hardware preamp designs from each manufacturer vary, they all have different total gain amounts, control ranges, and control response curves, whether Mic, Line, or Hi-Z.
- If a Unison plug-in does not contain settings that are available on Apollo (pad, low cut filter, etc), the Apollo settings are not changed when the Unison plug-in settings are loaded, and the Apollo settings are still available for control via Apollo's front panel and/or Console channel.
- When a Unison plug-in is removed from the PREAMP insert, Apollo's mic input impedance reverts to its default value of 5.4K Ohms.
- When the original hardware preamp being emulated by the Unison plug-in has a Hi-Z (instrument) input and associated Hi-Z input switch, this switch is unavailable in the Unison plug-in interface. Instead, the Unison plug-in's Hi-Z input is automatically selected when a mono (tip-sleeve) plug is inserted into the Unison channel's front panel Hi-Z input jack.

(Continued)

- If Apollo is disconnected from the host computer (standalone mode), the Unison plug-in can no longer be controlled from Apollo's front panel. However, the signal continues to be processed by the Unison plug-in, using the values that were active when the connection was lost. Note that if Gain Stage Mode is active when the host connection is lost, the gain stage can apparently be switched from the front panel. However, the actual gain stage being controlled does not change.

Chapter 6: Working With Apollo

Apollo Setups Overview

Apollo is a powerful and flexible audio interface that can be used in many ways. This chapter explains how to apply Apollo in various digital audio environments.

Although the exact techniques for configuring and using Apollo will vary according to needs, its application will generally fall within one of the main categories below. Each application is detailed later in this chapter.

Audio interface without DSP

Apollo functions like other non-DSP audio interfaces when it is used without the Console application, the Console Recall plug-in, or UAD Powered Plug-Ins. See [“Using Apollo as an Audio Interface” on page 88](#) for details.

Digital mixer with Console

Apollo and Console can be used without a DAW or any other audio software, providing access to all Apollo features, its DSP mixing functionality, and Realtime UAD Processing. See [“Using Apollo with Console \(without a DAW\)” on page 90](#) for details.

Standalone use without computer

Apollo can be used as a digital mixer (with limited functionality) without Console or any connection to a host computer. See [“Using Apollo Without A Computer” on page 91](#) for details.

With a DAW (without Console)

When Apollo is used with a DAW but without the Console application (or Console Recall plug-in), the DAW controls all signal I/O routing, software monitoring, and UAD-2 DSP-accelerated UAD Powered Plug-Ins processing. See [“Using Apollo with a DAW \(without Console\)” on page 92](#) for details.

With Console and a DAW

Console is used concurrently with a DAW when low-latency monitoring and/or recording of Apollo’s inputs with (or without) Realtime UAD processing is desired. This workflow completely eliminates the I/O buffering latencies associated with software monitoring. Console’s Virtual I/O feature can also be used with the DAW to route virtual software instruments, or any other DAW outputs, into Console for Realtime UAD Processing. See [“Using Apollo Concurrently with a DAW and Console” on page 95](#) for details.

UAD Powered Plug-Ins: Console versus DAW

There are some fundamental differences when UAD Powered Plug-Ins within Console or within a DAW. See [“About UAD Powered Plug-Ins Processing” on page 86](#) for details.

About UAD Powered Plug-Ins Processing

Two Distinct Methods with Apollo

Apollo features two distinct methods for using UAD Powered Plug-Ins: The “Console processing method” for low-latency monitoring and tracking with Realtime UAD Processing via the Console application, and the “DAW processing method” for DSP-accelerated UAD-2 processing via VST, RTAS, AAX, and Audio Units plug-ins in DAW applications.

These two methods are not a switched mode, but instead simply depend on which application (Console or DAW) uses the UAD plug-ins. Both methods can be used simultaneously for extremely powerful and flexible signal monitoring, routing, and processing.

Console Processing Method

UAD Powered Plug-Ins run in realtime only when used within Console. Using Realtime UAD Processing in Console is optimum for artists and engineers that need to monitor and capture performances without DAW I/O buffering latency and its associated hindrances.

The special Realtime UAD Processing functionality is achieved via Apollo’s unique ultra-low latency DSP+FPGA+Console design. Although *every* audio interface has undetectable latency that is inherent to the A/D–D/A process, routing Apollo’s input signals through UAD Powered Plug-Ins within Console *does not add to this inherent latency*.

Up to four UAD plug-in instances can be inserted serially (“stacked” or “chained”) on each of Console’s analog/digital inputs and/or auxiliary buses simultaneously, without adding to the inherent I/O latency.

Note: *Upsampled UAD plug-ins add latency when used within Console or a DAW. See “Upsampled UAD plug-ins” on page 109 for more information.*

Console inputs with Realtime UAD processing can be routed into the DAW via Apollo’s device drivers, and optionally recorded as either processed (wet) or unprocessed (dry) audio using the [Insert Effects](#) function in Console.

Important: *UAD plug-ins used within Console for Realtime UAD Processing must run on the DSP within Apollo. If other UAD-2 devices are active in the same system, DSP on those devices cannot be used for Realtime UAD Processing.*

DAW Processing Method

When UAD Powered Plug-Ins are used within compatible VST, RTAS, AAX 64, or Audio Units host DAW applications, I/O buffering is used for plug-in processing because the data must be shuttled back and forth between the DAW and Apollo. In this scenario, the UAD-2 DSP inside Apollo behaves exactly like other UAD-2 devices such as UAD-2 Satellite and UAD-2 PCIe cards for UAD plug-in processing.

Hardware I/O buffering with a DAW adds latency that is compensated by the host DAW's automatic delay compensation during mixing (i.e., all tracks remain time-aligned). However, at larger buffer sizes this latency makes software monitoring via the DAW mixer while tracking with UAD Powered Plug-Ins less practical. [Using Apollo Concurrently with a DAW and Console](#) eliminates this latency during tracking because software monitoring is not used — the DSP mixer inside Apollo is used for “hardware” monitoring instead.

***Note:** See “[Chapter 8: Latency & Apollo](#)” on [page 108](#) for detailed information about latency.*

Latency is not an issue during mixdown in a DAW; realtime processing is not necessary because the performances are already captured. The benefits of using Apollo's integrated DSP acceleration during mixing include the off-loading of plug-in processing from the host computer's CPU and the sonic rewards of UAD Powered Plug-Ins, which run exclusively on UAD-2 and Apollo platforms.

Concurrent use of UAD Plug-Ins in Console and a DAW

UAD Powered Plug-Ins can be used within Console and a DAW simultaneously. In this scenario, Apollo's DSP resources are shared between the two applications. Realtime UAD Processing is available via Console, and I/O buffered (non-realtime) UAD processing is available via VST, RTAS, AAX 64, or Audio Units plug-ins in the DAW. See [page 95](#) for complete details.

***Note:** Apollo, like other UAD devices, can only load UAD Powered Plug-Ins which are specifically designed to run on UAD DSP accelerators. Host-based “native” plug-ins cannot run on the UAD DSP.*

Using Apollo as an Audio Interface

Apollo functions like other (non-DSP) audio interfaces when it is used without the Console application, the Console Recall plug-in, or UAD Powered Plug-Ins. Apollo's [Core Audio](#) and [ASIO](#) drivers enable it to be used for computer audio I/O routing with any Core Audio- or ASIO-compliant audio software, including DAWs, music players (e.g., iTunes), system software alert sounds, and similar applications.

Accessing Apollo I/O via Core Audio and ASIO

Audio is routed to and from Apollo via its Core Audio (Mac) or ASIO (Windows) device drivers. The audio software accesses Core Audio and ASIO interfaces directly via the audio settings/preference panel in the software, or it just uses the audio device set as the preference in the operating system.

Apollo I/O Driver Names

Each Apollo input and output has a channel number and name provided by the Apollo drivers to Core Audio and ASIO. If an audio software application can access Core Audio/ASIO devices directly, it may be possible to designate specific inputs and/or outputs within the application.

All Apollo Driver I/O numbers and names are listed in [“Driver I/O Tables” on page 115](#). These values can be used to reference specific Apollo inputs or outputs by number or name if allowed by the application.

Setting the I/O in the audio software application

To access Apollo's I/O in an audio software application that can select Core Audio or ASIO devices directly, look for a setting in the audio software application's preferences called “audio setup” or “output device” or similar. Each application is different; consult the software application documentation for specifics.



Apollo selected as the Core Audio I/O device in Ableton Live preferences

Setting the I/O in the Operating System

If a software application doesn't have its own setting for accessing a Core Audio or ASIO device directly, it typically uses the device specified in the "Sound" control panel of the OS software. This sets the device for all system sounds, and any other device that uses the system device for audio I/O.

Note: To prevent system sounds from being inadvertently routed into Apollo's monitor outputs and/or DAW recordings, setting Apollo as the output for system sounds is generally not recommended when using a DAW.

Set the operating system's Input and/or Output device to use "Universal Audio Apollo" to route system sound to/from Apollo. This setup will assign system audio to the Apollo's default channels (1 & 2), which are routed to Apollo's left & right monitor outputs.

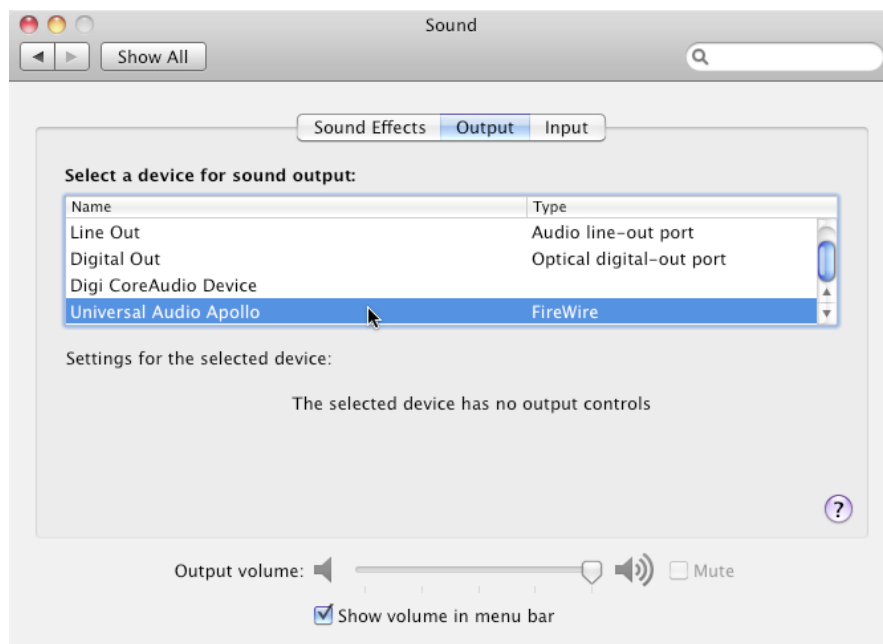

Apollo selected for system audio output in Mac OS X System Preferences

Using Apollo with Console (without a DAW)

Apollo and Console can be used without a DAW or any other audio software. Using Console without a DAW provides access to all Apollo functionality and simplifies the use of Apollo's digital mixing, monitoring, and Realtime UAD processing features when a DAW's recording and playback features are not needed.

Apollo has an internal DSP mixer for realtime mixing and monitoring of Apollo inputs, with optional Realtime UAD Processing using UAD Powered Plug-Ins. The software interface for this functionality is the Console application, but the actual mixing and signal processing occurs inside Apollo.

Using Console by itself

To use the Console Mixer by itself for input monitoring and Realtime UAD Processing, there aren't any special considerations; just launch Console and start using it. Full explanations of all Console features and functionality are in [“Chapter 3: Console Application” beginning on page 19](#).

Using Console with other audio applications

System Audio

When the OS is set to use Apollo for computer system audio ([page 89](#)), the computer system audio is routed to Console's monitor outputs and mixed with Apollo inputs (if any).

Apollo's input levels can be adjusted with Console's input channel faders, while the computer system's audio level at the monitor outputs is determined by the volume settings of the audio software using the system outputs. The computer system volume level is not adjusted in the Console Mixer.

With a DAW

DAWs have their own audio mixer. Understanding the interactions between Console and the DAW will help to ensure an optimized workflow in this scenario. See [“Using Apollo Concurrently with a DAW and Console” on page 95](#) for details.

Using Apollo Without A Computer

Standalone Use

Although the Console application and/or a DAW are required to unleash the full potential of Apollo, the unit can be used as a standalone digital mixer with limited functionality without any FireWire or Thunderbolt connection to a host computer.

Console settings that are retained on power cycle

All currently active I/O assignments, signal routings, and monitor settings are saved to internal firmware before Apollo is powered down, and recalled when power is re-applied. Therefore these last-used settings are available even when a host computer is not used.

UAD plug-ins are not retained on power cycle

UAD Powered Plug-In instantiations are not retained after powering down then powering up again, because the plug-in files must be loaded from the host computer.

Standalone use with UAD plug-ins

If UAD plug-ins are active when Apollo's connection to the host computer is lost (either by disconnecting the cable or shutting down the computer), Console's current UAD plug-in configurations remain active for Realtime UAD Processing until Apollo is powered down.

Disconnecting

Upon disconnection from the host computer, the following changes occur:

- Auxiliary buses are unmuted
- Solo is deactivated on all channels
- If multi-unit cascading, the clock source switches to Word Clock

Operation

After disconnecting, the following behavior applies:

- The LINK switch on Apollo's front panel cannot be used to link or unlink stereo channels. This point only applies if the host connection was lost; the switch does operate when Apollo is powered on before connecting to a host computer.
- If channels 1 & 2 are stereo linked and an instrument is plugged into one of the Hi-Z inputs, the stereo link is unlinked, and UAD plug-in processing is bypassed on both channels. The stereo link, and UAD processing, returns when the Hi-Z input is removed.

Using Apollo with a DAW (without Console)

When used with a DAW but without the Console application (or Console Recall plug-in), the DAW controls all signal I/O routing, software monitoring, and DSP-accelerated UAD Powered Plug-Ins processing.

***Note:** Apollo, like other UAD devices, can only load UAD Powered Plug-Ins which are specifically designed to run on UAD DSP accelerators. Host-based “native” plug-ins cannot run on the UAD DSP.*

Monitoring with the DAW

The primary function of Console is monitoring of Apollo’s inputs during live performance, with (or without) Realtime UAD Processing. When software monitoring is enabled in the DAW, Console’s input monitoring must be disabled to eliminate doubled signals.

***Important:** When the DAW’s software monitoring feature is enabled (when not using Console for input monitoring), Console’s inputs must be muted to avoid signal doubling at Apollo’s monitor outputs.*

Disable input monitoring in Console when software monitoring via the DAW

If Console’s input monitoring isn’t disabled, phasing and/or doubling of the monitored signal(s) will occur, because the input signal is being heard twice – first from the low-latency DSP mix (Console) and shortly thereafter from the higher latency software mix (DAW).

How to disable input monitoring in Console

To disable input monitoring in Console when using software monitoring in the DAW, open Console and mute all input channels within Console. Console can then be quit.

***Tip:** In Console, option-click any input MUTE switch to quickly toggle the mute state of all inputs.*

Using a DAW without Console is a typical workflow during mixdown, where low-latency monitoring is not required and buffering latency is not an issue because the tracks are already recorded. When recording new tracks, the DAW+Console workflow (following section) is recommended to take advantage of Apollo’s Realtime UAD Processing.

In this scenario, Apollo functions as two “separate” devices: an audio interface, and a UAD-2 DSP accelerator:

1. **Audio Interface** – The DAW accesses and routes Apollo’s audio interface I/O via the Core Audio or ASIO device drivers. Audio I/O latency is determined by the DAW’s I/O buffers size setting.
2. **UAD-2 DSP Accelerator** – The DAW controls Apollo’s internal UAD-2 DSP via UAD plug-ins in VST, RTAS, AAX, or Audio Units format that are loaded within the DAW. Buffering is used for UAD plug-ins because data from the DAW must be shuttled over FireWire or Thunderbolt to/from Apollo’s DSP.

Accessing Apollo's I/O in a DAW

Specifying the audio interface device

To access Apollo's I/O within a DAW, the DAW's audio engine must be configured to use Apollo as the audio interface device. Specific instructions vary by DAW; consult the DAW documentation for specifics. The [I/O Buffer Size](#) setting, which determines the overall DAW I/O latency, is usually set in the same window.

See [“Setting the I/O in the audio software application” on page 88](#) for an example.

I/O Complement

The specific inputs and outputs available, and their names, vary by Apollo model. For complete lists, see [“Driver I/O Tables” on page 115](#).

Selecting Apollo's Inputs and Outputs

When the DAW is configured to use Apollo as the audio interface device, the DAW's audio input and output channels can be routed to/from Apollo's I/O via the device drivers.

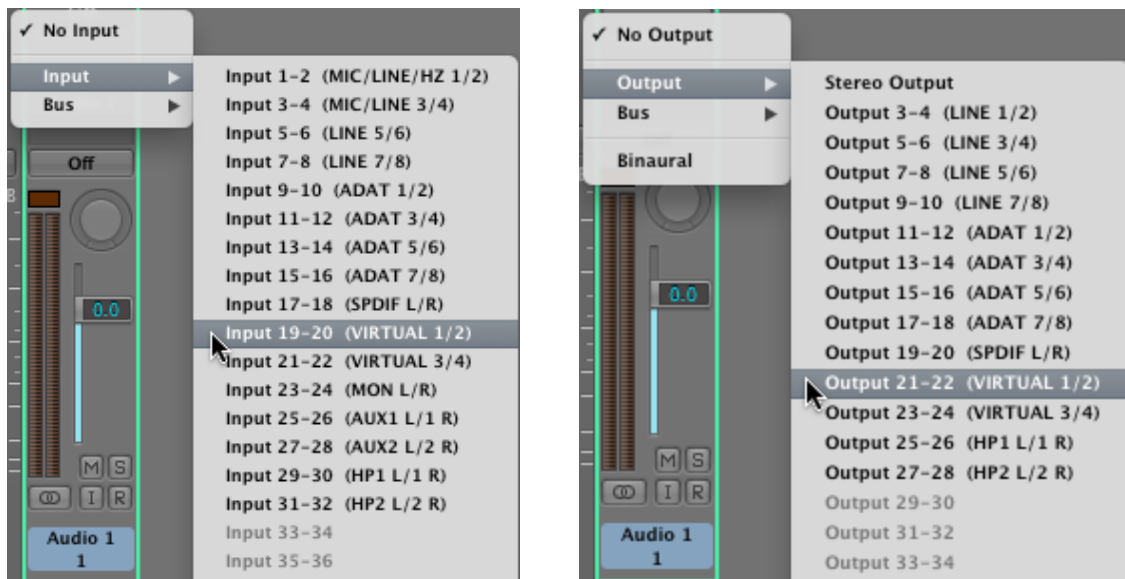

Apollo's inputs (left) and outputs (right) as they appear when configuring stereo I/O in Logic Pro

Default Outputs

The main stereo outputs of a DAW usually output to channels 1 & 2 by default. Therefore, since channels 1 & 2 correspond to Apollo's monitor outputs, the DAW's main outputs are sent to Apollo's monitor outputs by default. The channels used for output can usually be changed in the DAW.

Apollo I/O Driver Names

Each Apollo input and output has a channel number and name provided by the Apollo drivers. The DAW uses these numbers or names to designate the specific inputs and/or outputs within the DAW.

Numbers vs. Names

Apollo's drivers describe all I/O channels by name and number, but what is actually displayed depends on each particular DAW. Names are not displayed by all DAWs (e.g., Ableton Live), or the driver name display mode may need to be changed in the DAW (e.g., Apple Logic Pro).

All Apollo driver I/O numbers and names are listed in [“Driver I/O Tables” on page 115](#). These values can be used to reference specific Apollo inputs or outputs by name when selecting I/O in an application that does not display the driver names.

Using Apollo Concurrently with a DAW and Console

Console is used concurrently with a DAW when low-latency monitoring and/or recording of Apollo's inputs or mix buses with (or without) Realtime UAD Processing is desired. This workflow completely eliminates the I/O buffering latencies associated with software monitoring.

In this scenario, Console is used to control all input monitoring and Realtime UAD Processing when recording, and the DAW's software monitoring feature should be disabled.

Important: *To eliminate doubled signals, disable software monitoring in the DAW when Console is used to monitor Apollo's inputs. Refer to the DAW documentation for specific instructions on how to defeat software monitoring in the DAW.*

Software Monitoring versus Hardware Monitoring

Software monitoring (listening to live inputs via the DAW mixer) has discernible latency due to audio interface I/O buffering. Hardware monitoring via an audio interface's internal DSP mixer (e.g., Apollo's Console application) does not have discernible latency, because the live audio is internally routed directly from the inputs to the outputs without DAW I/O buffering (see [“Latency Basics” on page 111](#) for detailed explanations).

Monitoring with Console

The primary function of Console is monitoring of Apollo's inputs during live performance, with (or without) Realtime UAD Processing. When used with a DAW, Console is used as a monitor mixer that functions separately from the DAW's software monitoring mixer.

Disable Software Monitoring in the DAW when using Console

When Console is used for live input monitoring with a DAW, the DAW's software monitoring feature should be disabled. If it isn't, phasing and/or doubling of the monitored signal(s) will occur, because the input signal is being heard twice – first from the low-latency DSP mix (Console) and shortly thereafter from the higher latency software mix (DAW).

Routing and Recording Console Inputs and Mix Buses

Recording Apollo inputs

This functionality is covered in [“Accessing Apollo's I/O in a DAW” on page 93](#).

Recording Console mix buses

Console's monitor and send bus outputs can be routed into the DAW for recording Console's active mixes. See [“Virtual I/O” on page 97](#) for details.

Recording Realtime UAD Processing

When monitoring Apollo's inputs with Realtime UAD Processing, those inputs can be recorded with processing (wet) or without processing (dry). This function is accomplished with the Insert Effects switch. See [“Insert Effects” on page 47](#) for details.

Console with the Console Recall Plug-In

The Console Recall plug-in offers additional convenience when using Apollo and/or the Console application in conjunction with a DAW. Its primary function is to store complete Console settings within the DAW project file.

When a DAW project is loaded containing the Console Recall plug-in and the “Synchronize” function in the plug-in is enabled, the Console settings stored within the newly-loaded DAW session are sent to Console. See [“SYNC” on page 70](#) for details.

Latency Compensation

Some latency is inevitable in complex digital audio environments such as when running a DAW with Console. Fortunately, when these applications are properly configured and operated, latency is not a deterrent because it is negligible during low-latency monitoring via Console, and automatically managed for time-alignment of recorded tracks via the DAW’s automatic delay compensation feature.

See [“Delay Compensation with Apollo” on page 108](#) for more information.

Recording multiple inputs simultaneously

Console’s Input Delay Compensation feature should be enabled to maintain phase alignment when monitoring and/or recording simultaneous multi-channel sources (such as a drum kit or multi-mic’d guitar amp) when Realtime UAD Processing is active in Console and some (or all) of the UAD plug-ins in Console are upsampled. See [“Input Delay Compensation in Console” on page 108](#) for complete details.

Latency Basics

For a complete overview of latency in a digital audio system, see [“Latency Basics” on page 111](#).

Virtual I/O

Overview

Apollo's device drivers carry various *virtual* (software only) input and output channels in addition to those directly associated with the hardware inputs and outputs. The virtual channels consist of Console's virtual inputs, Console's virtual outputs, and all of Apollo's bus outputs (the main monitor mix and all channel send mix buses).

Flexible, Pristine Signal Routing

Virtual I/O facilitates highly flexible signal routing via the DAW, without needing to reach behind the gear rack for manual cable patching. Additionally, because the virtual I/O channel audio streams are in the digital domain, a pristine audio signal path is maintained without requiring additional A/D–D/A conversions.

Virtual Inputs into Console

The virtual input channels enable any DAW output to be routed directly into Console's virtual inputs so Realtime UAD Processing with UAD plugins can be applied to the DAW signal(s).

This feature is particularly useful when performing live with virtual software instruments inserted in the DAW, because the throughput latency associated with I/O buffering is reduced in this configuration.

DAW outputs can be digitally routed into Console inputs for Realtime UAD Processing



Virtual Outputs into DAW

Virtual outputs enable any (or all) of Console's virtual input channels and Console's bus outputs (monitor and send mixes) to be directly routed to any DAW input so they can be recorded. With virtual outputs, it's easy to capture any Console signal, with or without Realtime UAD Processing.

Console outputs can be digitally routed into DAW inputs for recording and/or further routing



How To Route Any DAW Output Into Console's Virtual Inputs

To route a DAW output signal into Console for Realtime UAD Processing, simply assign any Console virtual channel (or channel pair, when the DAW source is stereo) as the output device for any DAW track, bus, or output. That DAW output signal then appears in the virtual input channel in Console, and it can be processed or routed the same as a hardware input.

At Right: Routing a DAW channel's outputs into Console's virtual inputs

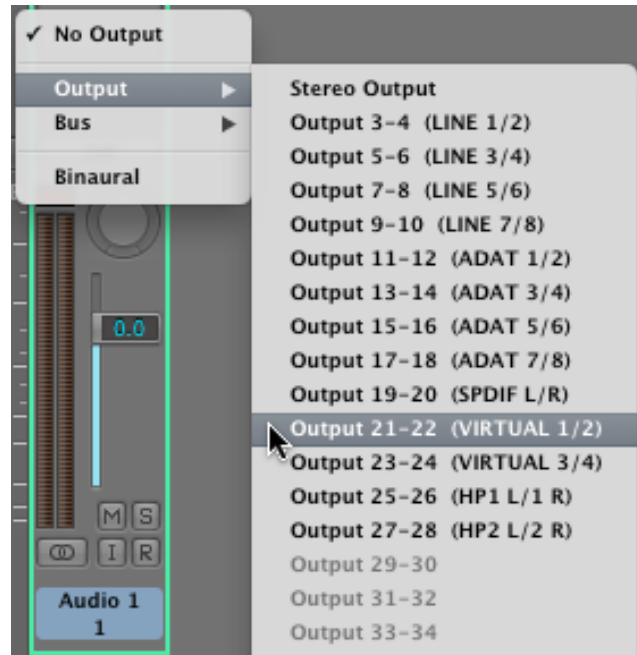

How To Route Any Console Virtual Output Into the DAW

To route a Console output signal into the DAW so it can be recorded, simply assign any Console virtual channel (or channel pair, when the Console source is stereo) as the input source for any DAW input. That Console signal can then be recorded or routed like any hardware input by the DAW.

Tip: This technique can be used to re-capture and record a software instrument performance that was virtually routed from the DAW into Console for Realtime UAD Processing.

At right: Routing Console's virtual outputs into the DAW channel's input. Note that any virtual output listed here (including mon, aux, HP, etc.) could be used as the DAW input.

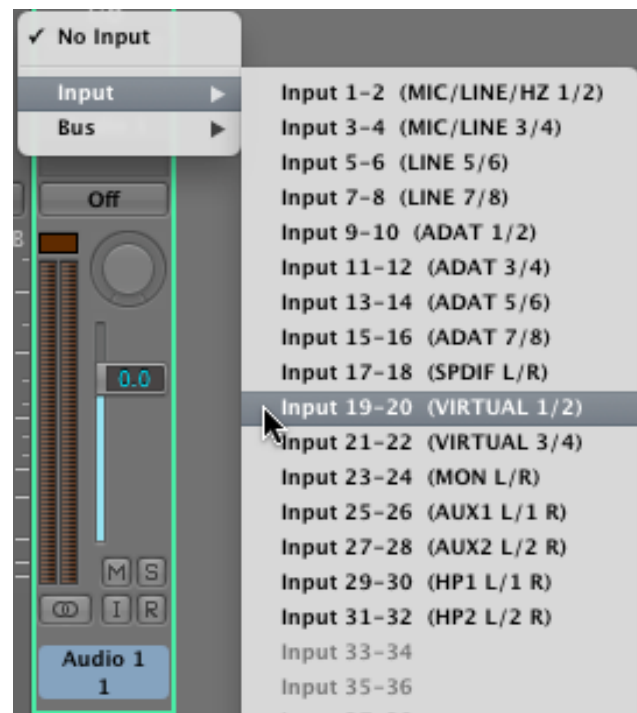

PT Mode

PT Mode accommodates Pro Tools software I/O by inserting NULL (empty) values at Apollo inputs 1–2 so line input and output channel numbering within Pro Tools is aligned. The setting also optimizes Apollo's I/O channels to accommodate the 32 I/O channels available in Pro Tools.

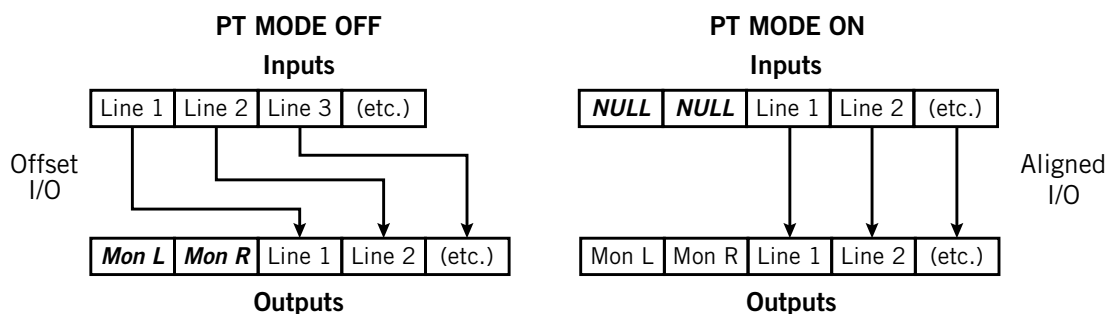

How PT Mode changes Apollo's I/O numbering

Enabling PT Mode

To enable PT Mode, click the PT Mode checkbox in the global interface settings area in the Interface panel within the Console Settings window.

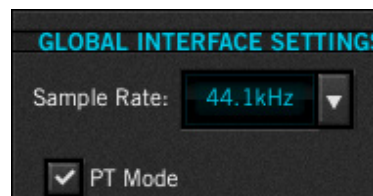

Changes To I/O Complement

Important: Enabling PT Mode changes the driver I/O complement. Quit all audio applications before changing the PT Mode setting.

DAW I/O driver numbering

PT Mode changes Apollo's driver I/O numbering and names. If a DAW project saved with PT Mode disabled (or saved prior to UAD v7.0.0) is subsequently opened when PT Mode is enabled, the DAW's channel I/O assignments may need to be adjusted.

The specific Apollo channel numbers and names when PT Mode is active are listed in the PT Mode tables in ["Driver I/O Tables" on page 115](#).

Optimized Apollo channels in Pro Tools

Because Apollo's I/O channel numbering exceed the 32 channels available in Pro Tools in certain configurations (such as when multi-unit cascading), the available I/O channels are optimized when PT Mode is active.

Note: Channel numbers higher than 32 are unavailable in Pro Tools when PT Mode is active. The specific channels that are unavailable in Pro Tools are displayed in italics within parentheses in the PT Mode tables in ["Driver I/O Tables" on page 115](#).

Pro Tools Hardware Inserts

To configure the Pro Tools hardware inserts so the insert labels are aligned with Apollo's I/O, the I/O needs to be offset in the Pro Tools I/O Setup window's "Insert" tab. This is accomplished by manually dragging each I/O insert pair to the right so they appear as in the screenshot below.

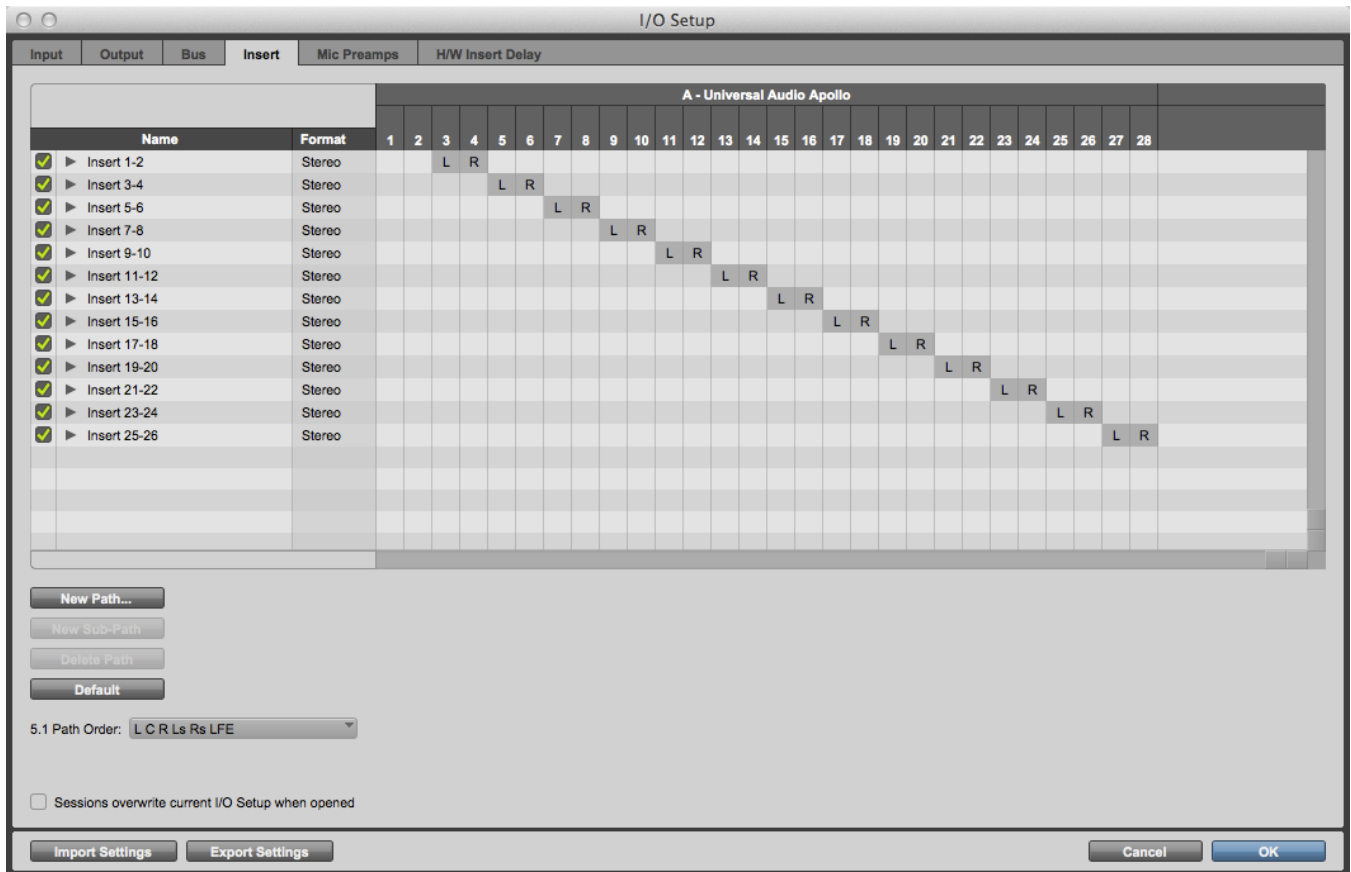

Pro Tools hardware inserts properly configured for Apollo I/O when PT Mode is active

Chapter 7: Multi-Unit Cascading

Multi-Unit Overview

Two Apollo or two Apollo 16 units can be cascaded together in a multiple-unit configuration. When two units are connected, both units are controlled within a single Console Mixer window, and the I/O complement of both units are available to the DAW via the device drivers. Operating a multi-unit system is nearly identical to that of a single-unit system for seamless expansion when more I/O is needed.

Note: Combining Apollo with Apollo 16 is an unsupported configuration.

Console Integration

When multi-unit cascading, the number of Console inputs is increased to match the increased hardware inputs. Both units share the same monitor and send buses for integrated mixing convenience.

Monitor and Expander Units

To facilitate Realtime UAD Processing and the mix bus integration within Console, one device must be designated as the monitor (master) unit and the other as the expander (slave) unit. In driver I/O list ordering, the monitor unit I/O precedes the expander unit I/O.

All Console mix bus outputs (monitor, auxiliary, headphone, cue) are available on the monitor unit only. The designated monitor/expander units can be switched within Console if desired.

Hardware Setups

In all multi-unit setups, specific hardware wiring connections are required, and only the monitor unit is connected to the host computer system. The expander unit is connected to the monitor unit, not the host computer.

The specific connections differ for Apollo and Apollo 16, and they differ depending on whether FireWire 800 or Thunderbolt is used for the host computer connection. Diagrams for all hardware setups are in this chapter starting on [page 102](#).

Note: The inter-unit optical cable is required for mix bus integration and when multi-unit cascading.

Constraints

Depending on the specific configuration, certain features and/or I/O streams are reduced when multi-unit cascading. See [“Constraints” on page 107](#) for details.

Driver I/O Tables

Driver I/O availability and numbering changes when multi-unit cascading and when PT Mode is enabled. For a complete list of all possible I/O states, see [“Driver I/O Tables” on page 115](#).

Multi-Unit Wiring Diagrams

Note: For maximum signal integrity, short cables (e.g., one to three feet in length) are recommended for all inter-unit connections in all multi-unit setups.

Multi-Unit Wiring (Apollo)

FireWire 800 Host Connection

Cables Required:

- One FireWire 800 cable for connecting to the host computer
- One FireWire 800 Cable for connecting between the two interfaces
- One ADAT optical cable for connecting between the two interfaces*

* At sample rates of 88.2 kHz and 96 kHz, two ADAT optical cables are required

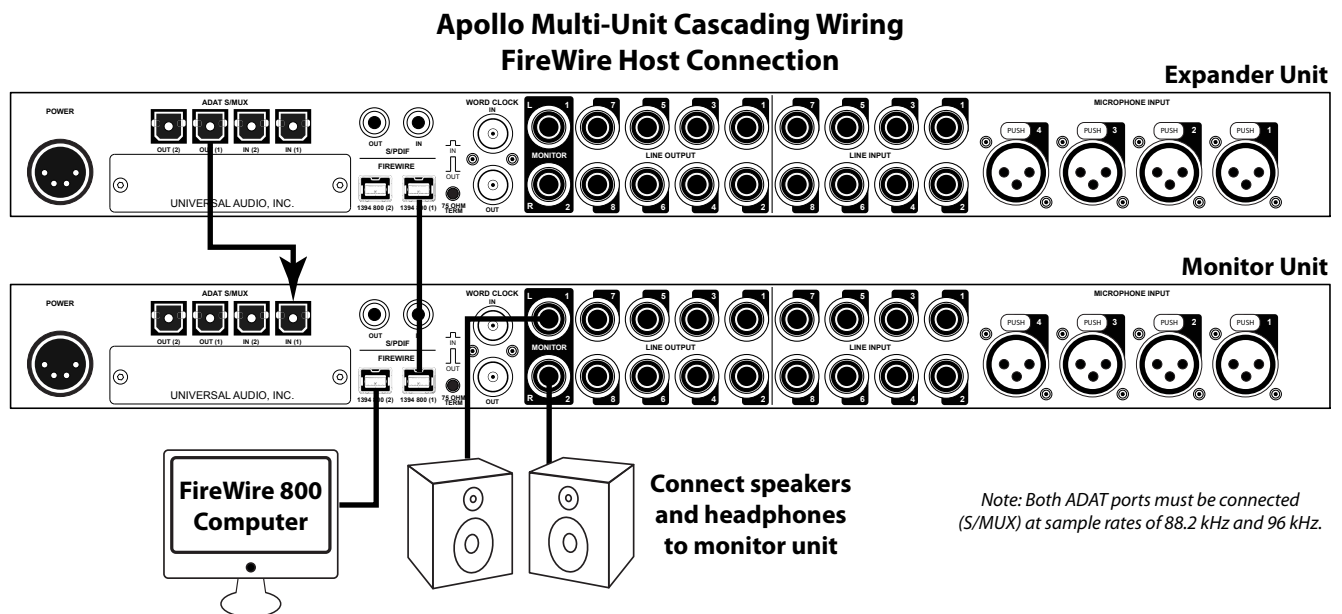

Key points for this setup:

- The lower Apollo is designated as the Monitor (master) unit
- The upper Apollo is designated as the Expander (slave) unit
- The Monitor unit is connected to the host computer via FireWire 800 (either Apollo FireWire 800 port can be used for this connection)
- The Expander unit is *not* connected to the host computer
- One FireWire 800 cable must be connected between the Expander and Monitor units (either Apollo FireWire 800 port can be used for this connection)
- One ADAT optical cable must be connected from the ADAT OUT (1) of the Expander unit to the ADAT IN (1) of the Monitor unit*
* At sample rates of 88.2 kHz and 96 kHz, a second ADAT optical must also be connected from the ADAT OUT (2) of the Expander unit to the ADAT IN (2) of the Monitor unit
- Monitor, headphone, and auxiliary outputs are connected to the Monitor unit only
- Power on the monitor unit before the expander unit

Multi-Unit Wiring (Apollo 16)

FireWire 800 Host Connection

Cables Required:

- One FireWire 800 cable for connecting to the host computer
- One FireWire 800 Cable for connecting between the two interfaces
- One MAD I optical cable for connecting between the two interfaces (single or dual MAD I cables can be used)

Apollo 16 Multi-Unit Cascading Wiring FireWire Host Connection

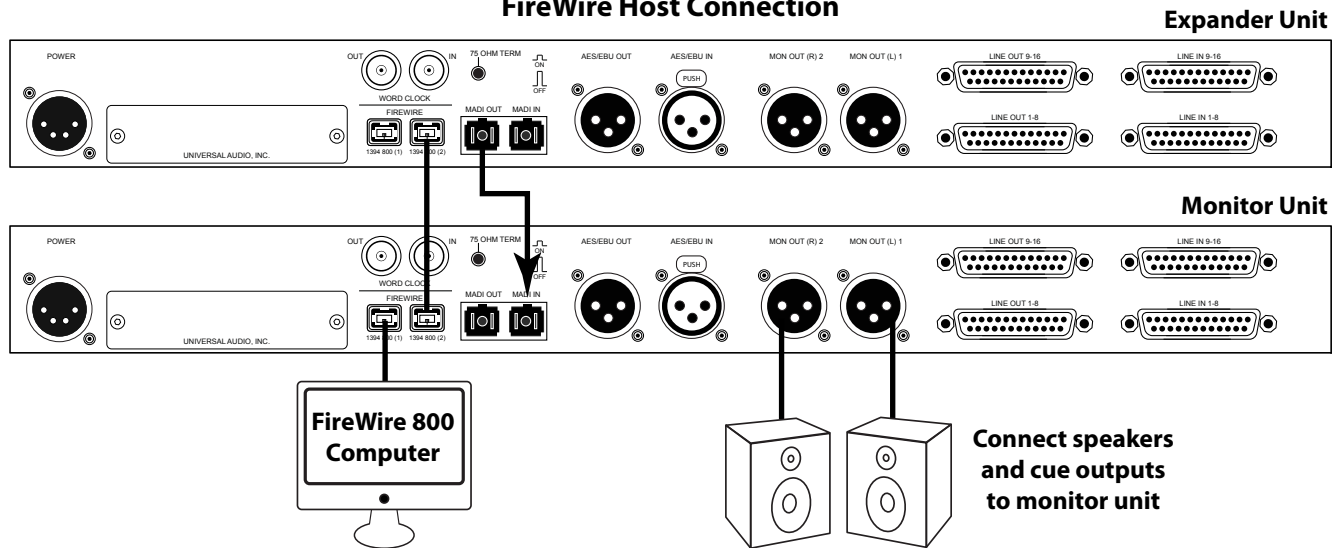

Key points for this setup:

- The lower Apollo 16 is designated as the Monitor (master) unit
- The upper Apollo 16 is designated as the Expander (slave) unit
- The Monitor unit is connected to the host computer via FireWire 800 (either Apollo 16 FireWire 800 port can be used for this connection)
- The Expander unit is *not* connected to the host computer
- One FireWire 800 cable must be connected between the Expander and Monitor units (either Apollo 16 FireWire 800 port can be used for this connection)
- One MAD I optical cable must be connected from the MAD I OUT of the Expander unit to the MAD I IN of the Monitor unit
- Monitor and cue outputs are connected to the Monitor unit only
- Power on the monitor unit before the expander unit

Multi-Unit Operation

Power On Sequence

When multi-unit cascading, the order in which the Apollo monitor and expander units are powered on is critical for proper initialization. For optimum results, follow the recommended power up sequence:

1. Shut down the host computer system
2. Confirm monitor/expander designations and wiring (see above)
3. Power on the monitor unit
4. Power on the expander unit
5. Start the host computer

Monitor Level Controls

Monitor Outputs

When multi-unit cascading, both units share the same monitor mix bus. The monitoring speaker system must be connected to the monitor outputs of the monitor unit. The monitor outputs of the expander unit are disabled.

Monitor Knobs

The monitor knob on the front panel of expander unit, and its surrounding green LED ring, are disabled. Use the front panel monitor knob on the monitor unit (or the monitor level controls in Console or the Console Recall plug-in) to adjust the monitor output level.

Send Bus Outputs

When multi-unit cascading, the send mix buses of both units are summed and these buses are sent to the monitor unit only. The associated outputs on the expander unit are disabled.

Clocking

Internal

When the units are connected according to the [Multi-Unit Wiring Diagrams](#), all system clocking and clock settings are automatically configured by the device drivers. The Console Settings>Interface panel's clock source should remain on "Internal" unless specifically clocking to an external (non-Apollo) device.

Note: When the clock source in the Console Settings window is set to Internal, "EXT" will illuminate on the designated expander unit hardware's front panel.

External

When using an external clock with Apollo multi-unit cascading, both Apollo units are automatically configured by the device drivers to use the external clock when the Clock Source setting on the monitor unit is set “External” (the Clock Source setting only needs to be changed on the monitor unit).

Important: When synchronizing to external clock, connect the external clock source to the monitor unit **only**. The expander unit always synchronizes to the monitor unit.

Multi-Unit FireWire Bandwidth

Bandwidth Consumption

When multi-unit cascading while connected to the host computer via FireWire, more FireWire bandwidth is consumed by the additional I/O streams, so less bandwidth is available for UAD plug-ins used within the DAW.

Note: FireWire bandwidth is not consumed by UAD plug-ins used within Console, nor when Thunderbolt is used for the host computer connection. The UAD Bandwidth Allocation does not apply in these scenarios.

Use of Hard Drives on FireWire Bus

To keep FireWire bandwidth available for UAD plug-in processing within the DAW when multi-unit cascading, running FireWire hard drives for audio session files on the same FireWire bus as Apollo is not recommended. Using USB, eSATA, or internal hard drives for audio session files is recommended instead.

Recommended Multi-Unit UAD Bandwidth Allocation Values

The values in the table below are recommended as starting points when tuning the UAD Bandwidth Allocation with multi-unit cascading. See [“Optimizing FireWire Performance” beginning on page 16](#) for complete details about this setting.

Multi-Unit Cascading Recommended UAD Bandwidth Allocation Values				
Sample Rate (kHz):		44.1, 48	88.2, 96	176.4, 192
Mac:	Apollo	70%	50%	N/A*
	Apollo 16	60%	35%	
Windows:	Apollo	70%	45%	N/A*
	Apollo 16	60%	25%	
I/O buffer setting for best playback results		512	1024	N/A*
*Multi-unit cascading is unavailable at these sample rates				

Cascaded Unit Tabs



Monitor/Expander Designation

A second Unit Tab appears when multi-unit cascading. The unit tab ordering defines the monitor/expander software designations. The tab on the left always represents the monitor unit; the tab on the right represents the expander unit.

Expander Unit Removal

If the expander unit is powered down or removed from the system, the expander unit's tab can be deleted. To delete the unit tab, right-click on the tab and select "Delete" from the menu.



Note: If the expander unit is powered down or removed from the system, the expander unit's tab must be deleted before the sample rate can be changed to 176.4 kHz or 192 kHz.

Monitor/Expander Swap

The monitor/expander designations are associated to the hardware ID of each unit. If the hardware wiring setup is reversed to change the monitor and expander designations, Console must be manually switched to reflect the hardware change. This is accomplished by re-ordering the tabs in Console.

Swapping the Unit Tab order

To swap the monitor and expander designation ordering in Console, click+hold a unit tab, then drag it to the other tab. A gray double arrow appears when a tab is "grabbed" and the swap is performed when the double arrow is orange and the mouse is released.

Important: Swapping the monitor/expander order changes the driver I/O configuration. Quit all audio applications before performing this action.



Console Recall Session Management

Single-to-Multi Session

If a Console session was created and saved with a single-unit setup and the session is subsequently opened with a multi-unit setup, the expander unit is automatically added to the session (a second unit tab is added to the session) and the number of Console inputs expands accordingly.

Multi-to-Single Session

If a Console session was created and saved with a multi-unit setup and the session is subsequently opened with a single-unit setup, the expander unit is retained in the session, but the host status indicator "dot" will be red indicating the expander unit is recognized. The expander unit can be removed from the session via the [Identify and Rename Menu](#) if desired.

Constraints

Certain features and/or I/O streams are reduced when multi-unit cascading due to limited audio bandwidth or technical constraints required to maintain integrated mix buses with Realtime UAD Processing capabilities. These constraints are listed below.

Auxiliary 2 (Apollo only)

- Aux bus 2 is unavailable when multi-unit cascading with Apollo.

High Sample Rates

176.4 kHz and 192 kHz

- Multi-unit cascading is unavailable at sample rates of 176.4 kHz or 192 kHz.

88.2 kHz and 96 kHz (Apollo only)

- Both ADAT ports must be used for S/MUX connections when multi-unit cascading at sample rates of 88.2 kHz or 96 kHz.

PT Mode

- Avid Pro Tools allows 32 channels of I/O with non-Avid branded audio interfaces. Because audio streams exceed this count when multi-unit cascading, some Apollo I/O channels are unavailable in PT Mode when multi-unit cascading.

The specific Apollo channel numbers and names that are available when PT Mode is active are listed in the [“Driver I/O Tables” on page 115](#).

Combining Different Apollo Models

- Combining Apollo with Apollo 16 is an unsupported configuration.

Chapter 8: Latency & Apollo

Delay Compensation with Apollo

System Latency Overview

System latency encapsulates all latencies induced within the typical digital audio workstation environment. See [“Latency Basics” on page 111](#) for a detailed overview of where, when, and how latency is induced in this environment.

Driver Reporting

Any system latency that is induced by Apollo’s I/O, Console, and/or UAD Powered Plug-Ins is reported by Apollo’s device drivers to the host audio software that is using the device.

The host software uses this reported device latency for its automatic delay compensation (ADC) engine. When properly configured in the DAW, ADC maintains phase coherency (time alignment) throughout the recording, overdubbing, and mixing process.

Automatic Delay Compensation in the DAW

Generally speaking, ADC should be enabled in the DAW when using Apollo, regardless of whether or not Console is used concurrently. The DAW’s ADC will perform the necessary housekeeping to keep tracks phase-aligned, regardless of the latency source (if any).

Input Delay Compensation in Console

Console has automatic Input Delay Compensation (IDC), which is controlled by the [Input Delay Compensation](#) menu in Console Settings. Console IDC maintains phase alignment across all Console’s analog and digital inputs when [Upsampled UAD plug-ins](#) are used in Console.

For example: If two microphones are used on an acoustic source (such as a drum kit) and an upsampled plug-in is used on one of the mic channels but not the other, without input delay compensation, the phase of the two mic channels would no longer be aligned.

How Console IDC works

Console IDC automatically adds small amounts of delay to each Console input that is *not* delayed by upsampled plug-ins, so all Console inputs are still phase aligned. In other words, all compensated inputs are automatically delayed by the same amount.

Upsampled UAD plug-ins

Some UAD plug-ins are *upsampled*, meaning their internal sample rate is increased to achieve sonic design goals. When upsampled UAD plug-ins are used in Console, additional latency is induced in the channel(s) using the plug-in(s).

Although the latency added by upsampled UAD plug-ins is negligible (typically between 0-300 samples, depending on the plug-in and sample rate), this extra latency can affect phase coherency in a session.

Upsampled Latency Values

For a chart of specific upsampling latency values for UAD plug-ins, see the [UAD Plug-Ins Manual](#).

When To Use Console Input Delay Compensation

Console IDC is required to maintain phase alignment only when **BOTH** of the following conditions are active:

1. Multiple Console inputs are used for a single source (such as a drum kit using multiple microphones), and
2. Any of those input channels contain upsampled UAD plug-ins.

***Tip:** When IDC is not needed, disable Console IDC for the lowest possible input latency.*

Effect of Console's IDC setting

In Console

In Console, the amount of delay added by the IDC engine is automatic. Only the minimum amount of delay actually required to compensate the input(s) is applied (up to the maximum value of the setting), maintaining the lowest possible latency for phase alignment at all times.

For example: When the IDC value is Short (100 samples – the default value) and only 31 samples is actually required to compensate, then only 31 samples of delay will be applied to the other Console inputs.

In the DAW

In the DAW, the amount of delay added by Console's IDC engine is static. The extra samples are always added to all inputs in the DAW, even if no upsampled plug-ins are active. However, this overall additional input latency is reported by Apollo's drivers, so it is automatically compensated by the DAW's ADC.

Input Delay Compensation Values	
Setting Name	Extra Delay (samples)
Off	0
Short	100
Medium	200
Long	1000

For example: When the IDC value is Short (100 samples – the default value) and only 31 samples is actually required to compensate, 100 samples is still added to all inputs in the DAW. If using software monitoring via the DAW, the extra (unnecessary) delay could be detected.

***Note:** By default, Console Input Delay Compensation is enabled with the Short value (100 samples).*

Software monitoring with Console IDC

When software monitoring via the DAW and Console IDC is enabled, the lowest effective Console IDC setting is recommended to minimize monitoring latency. If using Console for monitoring and software monitoring via the DAW is disabled, the IDC value isn't as critical because Console will dynamically deliver the lowest possible monitoring latency.

UAD-2 DSP Resources

Console IDC uses a small percentage of Apollo's UAD-2 DSP. To maximize DSP resource availability for UAD plug-ins, disable Console IDC if it is not needed.

Special Cases: UAD Precision Multiband and UAD Ampex ATR-102

These two upsampled UAD plug-ins have extra latency values that exceed the capacity of Console's IDC engine even at the maximum setting (Long). These plug-ins are designed to be used on outputs of a DAW during mixdown, where latency is not a consideration. If using these plug-ins in Console, the Input Delay Compensation feature may need to be disabled or ignored.

Latency Basics

Latency (delay) is an inherent factor in digital audio systems because of A/D-D/A conversion, I/O buffering in the DAW, plug-in signal processing, and other aspects.

Although there are ways to mitigate latency (such as delay compensation and/or low-latency monitoring), it always exists to some degree when working with systems that combine analog and digital audio. These concepts are explained in greater detail below.

Audio Interface Latency

Every audio interface that performs A/D and/or D/A conversion induces latency as a result of the conversion process. This inherent A/D–D/A latency is essentially undetectable. A/D–D/A latency usually depends on the sample rate, with higher sample rates inducing less latency (higher rates = less time required for conversion).

An audio interface’s “analog I/O round-trip latency” specification refers to how long it takes for an analog signal at an interface input to reappear at the same interface’s analog output after both A/D and D/A conversion. Apollo’s audio interface analog I/O round-trip latency is 1.1 milliseconds at a sample rate of 96 kHz.

Console Mixer Latency

Apollo’s Console Mixer is used for low-latency monitoring (cue mixing) of Apollo’s analog and digital inputs. Using Console to monitor Apollo’s inputs may or may not add to the inherent analog I/O round-trip latency, depending on how it is configured:

Console without UAD plug-ins – When Console is used without UAD plug-ins, monitoring Apollo’s inputs via Console does not add any latency. In this configuration, Apollo’s analog I/O round-trip latency is still 1.1 milliseconds at 96 kHz.

Console with Realtime UAD Processing – When Console is used for Realtime UAD Processing with UAD Powered Plug-Ins that are not upsampled, monitoring Apollo’s inputs via Console *does not add any latency*.

In this configuration, Apollo’s analog I/O round-trip latency is still 1.1 milliseconds at 96 kHz, even if up to four UAD (non-upsampled) plug-ins are serially “stacked” (chained) on a single Apollo analog and/or digital input.

Multiple Apollo inputs can have up to four UAD (non-upsampled) plug-ins each (up to the limit of available DSP resources); this configuration also *does not add any latency*.

Note: *Upsampled UAD plug-ins add latency when used in Console or a DAW. See [Upsampled UAD plug-ins](#) below for details.*

Console Auxiliary Buses – The outputs of the auxiliary buses in Console have 32 samples of additional latency. This is necessary to maintain the lowest possible input latency.

Upsampled UAD Plug-Ins

Some UAD Powered Plug-Ins are *upsampled*, meaning their internal sample rate is increased to achieve sonic design goals. Depending on the session sample rate, upsampled UAD plug-ins can add additional latency when used in the Console Mixer and/or a DAW.

Although the latency added by upsampled UAD plug-ins is negligible (typically between 0-300 samples, depending on the plug-in and sample rate), this extra latency can affect phase coherency in a session. However, phase is managed automatically by [Input Delay Compensation in Console](#) and [Automatic Delay Compensation in the DAW](#).

Note: For specific values, see [“Latency Basics” on page 111](#).

DAW Latency

Most DAWs use I/O buffering to shuttle audio data back and forth between the audio interface and the DAW. This I/O buffering induces additional latency with any audio interface (not just Apollo).

I/O Buffer Size

The amount of DAW latency is usually determined by the DAW’s I/O interface *buffer size* setting. Low buffer sizes reduce latency, but increase the host computer’s CPU loading. If the buffer size is set too low, host CPU overloads and/or audio artifacts such as clicks, distortion, or dropouts can occur.

Monitoring Live Performance During Recording

DAW latency can be a problem during recording when “software monitoring” via the DAW’s mixer, because the buffering delay is a distraction; an artist cannot hear their performance in realtime. DAW latency when recording with Apollo is mitigated by using the Console Mixer for live performance monitoring, where buffering latency does not apply.

Time-Alignment Of Newly-Recorded Tracks With Previously-Recorded Tracks

Dealing with latency is also important with DAWs for time-alignment of newly-recorded tracks and previously-recorded tracks which are inevitably shifted from the I/O buffering process.

The solution is to use the automatic delay compensation (“ADC”) feature of the DAW. Most modern DAWs, including Console, have automatic delay compensation. For more information about system latency and its compensation, see [“Delay Compensation with Apollo” on page 108](#).

UAD-2 DSP Latency

When UAD Powered Plug-Ins are used within a DAW (not Console), I/O buffering is used to shuttle audio data back and forth between the UAD-2 inside Apollo and the DAW, which induces additional latency.

This UAD-2 DSP “DAW processing method” latency is determined by the [I/O Buffer Size](#) setting. This latency is unrelated to the (indiscernible) audio interface I/O latency (they are separate processes).

UAD-2 DSP latency makes tracking through UAD plug-ins in the DAW via software monitoring problematic for the performer because again, an artist cannot hear their performance in realtime.

The issue of UAD-2 DSP latency when recording with Apollo is eliminated by using the Console Mixer for live performance monitoring with optional Realtime UAD Processing, where buffering latency does not apply.

Does all this latency stuff really matter?

With Apollo, not really. Performance latency is not a factor because of Console’s low latency monitoring; and recording (track alignment) latency during recording, overdubbing, and mixing is automatically compensated by Console and the DAW.

Chapter 9: Device Drivers

Apollo Drivers Overview

The Apollo device drivers are the low-level software files that instruct the computer's operating system on how to communicate with the Apollo hardware. The drivers are loaded during system startup so that whenever Apollo is connected, the device is ready to accept instructions from the OS. Apollo's drivers control Apollo's audio interface, Console Mixer, and UAD-2 functionality.

Core Audio and ASIO

Apollo's audio drivers use the Core Audio (Mac) and ASIO (Windows) [APIs](#). Apollo's normal (non-DSP) audio interface features are simply seen as Core Audio or ASIO device; therefore any Core Audio/ASIO-compliant software can use Apollo for audio I/O.

UAD Mixer Engine

The Console application and Console Recall plug-in don't actually communicate directly with Apollo. Instead, they communicate with the *UAD Mixer Engine*, which is the central software hub for all Console and Console Recall functionality. The UAD Mixer Engine behaves as a server for Apollo's internal DSP mixer that runs in the background, so Console does not have to be open for Apollo to function.

The UAD Mixer Engine is a system-level application that is automatically launched during system startup and is always running during normal operation. The UAD System Menu is its only interface, which can be accessed from the OS X Menu Bar (Mac), or the Windows System Tray (Windows).

Driver I/O Complement

The specific inputs and outputs that are available to the DAW depends on the active configuration. The I/O complement changes when PT Mode is enabled, at high sample rates, and when multi-unit cascading. The specific I/O complements are listed in the [Driver I/O Tables](#) in this chapter.

Driver Names and Numbers

Apollo's drivers describe all I/O channels by name and number, but what is actually displayed in the DAW's I/O assignment lists depends on each particular DAW. Names are not displayed by all DAWs (e.g., Ableton Live), or the driver name display mode may need to be changed in the DAW (e.g., Apple Logic Pro).

Virtual I/O

Apollo's device drivers carry various *virtual* (software only) input and output channels in addition to those directly associated with the hardware inputs and outputs. The virtual channels consist of all of Apollo's bus outputs (the main monitor mix and all channel send mixes) and Console's virtual inputs. Virtual I/O facilitates highly flexible signal routing via the DAW. See [“Virtual I/O” on page 97](#) for details about this feature.

Driver I/O Tables

Tables in this section list the I/O numbers and names for all Core Audio/ASIO streams available in every possible configuration. All configurations are listed in the table below. Click an item to jump directly to that table.

Tip: Each table is on a single page. For convenient reference with DAWs that don't display driver I/O channels by name, print the sheet for your particular setup.

Apollo Driver I/O Table Page Numbers			
		APOLLO	APOLLO 16
<i>Single Unit</i>			
PT Mode	OFF	page 116	page 122
	ON	page 117	page 123
<i>4x Sample Rates</i>			
PT Mode	OFF	page 118	page 124
	ON	page 119	page 125
<i>Multi-Unit</i>			
PT Mode	OFF	page 120	page 126
	ON	page 121	page 127

Driver I/O Table Notes

- The number in the left column is the channel number used by the DAW.
- All tables apply at all sample rates unless “4x Sample Rates” is denoted.
- “1x sample rates” is defined as 44.1 kHz and 48 kHz.
- “2x sample rates” is defined as 88.2 kHz and 96 kHz.
- “4x sample rates” is defined as 176.4 kHz and 192 kHz.
- (Apollo 16) Cue buses 3 and 4 are not available in Core Audio/ASIO channels. These buses are available in the Console Mixer only.
- In the multi-unit tables, the designated monitor unit I/O is in the left columns and the designated expander unit is in the right columns. In the tables and the driver I/O labels, the expander unit I/O is prefixed with the number 2 (e.g., “2 LINE 1”).

Apollo I/O, Single Unit, PT Mode Off

Apollo Driver I/O List Single Unit – PT Mode Off			
INPUTS		OUTPUTS	
1	MIC/LINE/Hi-Z 1	1	MON L
2	MIC/LINE/Hi-Z 2	2	MON R
3	MIC/LINE 3	3	LINE 1
4	MIC/LINE 4	4	LINE 2
5	LINE 5	5	LINE 3
6	LINE 6	6	LINE 4
7	LINE 7	7	LINE 5
8	LINE 8	8	LINE 6
9	ADAT 1	9	LINE 7
10	ADAT 2	10	LINE 8
11	ADAT 3	11	ADAT 1
12	ADAT 4	12	ADAT 2
13	ADAT 5	13	ADAT 3
14	ADAT 6	14	ADAT 4
15	ADAT 7	15	ADAT 5
16	ADAT 8	16	ADAT 6
17	S/PDIF L	17	ADAT 7
18	S/PDIF R	18	ADAT 8
19	VIRTUAL 1*	19	S/PDIF L
20	VIRTUAL 2*	20	S/PDIF R
21	VIRTUAL 3*	21	VIRTUAL 1*
22	VIRTUAL 4*	22	VIRTUAL 2*
23	MON L*	23	VIRTUAL 3*
24	MON R*	24	VIRTUAL 4*
25	AUX1 L*	25	HP1 L
26	AUX1 R*	26	HP1 R
27	AUX2 L*	27	HP2 L
28	AUX2 R*	28	HP2 R
29	HP1 L*		
30	HP1 R*		
31	HP2 L*		
32	HP2 R*		
<i>*Software Outputs (for DAW inputs)</i>		<i>*Software Inputs (for Console inputs)</i>	

Apollo I/O, Single Unit, PT Mode On

Apollo Driver I/O List Single Unit – PT Mode On			
INPUTS		OUTPUTS	
1	NULL 1	1	MON L
2	NULL 2	2	MON R
3	MIC/LINE/Hi-Z 1	3	LINE 1
4	MIC/LINE/Hi-Z 2	4	LINE 2
5	MIC/LINE 3	5	LINE 3
6	MIC/LINE 4	6	LINE 4
7	LINE 5	7	LINE 5
8	LINE 6	8	LINE 6
9	LINE 7	9	LINE 7
10	LINE 8	10	LINE 8
11	ADAT 1	11	ADAT 1
12	ADAT 2	12	ADAT 2
13	ADAT 3	13	ADAT 3
14	ADAT 4	14	ADAT 4
15	ADAT 5	15	ADAT 5
16	ADAT 6	16	ADAT 6
17	ADAT 7	17	ADAT 7
18	ADAT 8	18	ADAT 8
19	S/PDIF L	19	S/PDIF L
20	S/PDIF R	20	S/PDIF R
21	VIRTUAL 1*	21	VIRTUAL 1*
22	VIRTUAL 2*	22	VIRTUAL 2*
23	MON L*	23	VIRTUAL 3*
24	MON R*	24	VIRTUAL 4*
25	AUX1 L*	25	HP1 L
26	AUX1 R*	26	HP1 R
27	AUX2 L*	27	HP2 L
28	AUX2 R*	28	HP2 R
29	HP1 L*		
30	HP1 R*		
31	HP2 L*		
32	HP2 R*		
<i>*Software Outputs (for DAW inputs)</i>		<i>*Software Inputs (for Console inputs)</i>	

Apollo I/O, Single Unit, PT Mode Off, 4x Sample Rates

Apollo Driver I/O Single Unit – PT Mode Off 176.4 kHz & 192 kHz Sample Rates			
INPUTS		OUTPUTS	
1	MIC/LINE/Hi-Z 1	1	MON L
2	MIC/LINE/Hi-Z 2	2	MON R
3	MIC/LINE 3	3	LINE 1
4	MIC/LINE 4	4	LINE 2
5	LINE 5	5	LINE 3
6	LINE 6	6	LINE 4
7	LINE 7	7	LINE 5
8	LINE 8	8	LINE 6
9	ADAT 1	9	LINE 7
10	ADAT 2	10	LINE 8
11	ADAT 3	11	ADAT 1
12	ADAT 4	12	ADAT 2
13	S/PDIF L	13	ADAT 3
14	S/PDIF R	14	ADAT 4
15	MON L*	15	S/PDIF L
16	MON R*	16	S/PDIF R
17	AUX1 L*	17	HP1 L
18	AUX1 R*	18	HP1 R
19	HP1 L*	19	HP2 L
20	HP1 R*	20	HP2 R
21	HP2 L*		
22	HP2 R*		
*Software Outputs (for DAW inputs)			

Apollo I/O, Single Unit, PT Mode On, 4x Sample Rates

Apollo Driver I/O Single Unit – PT Mode On 176.4 kHz & 192 kHz Sample Rates			
INPUTS		OUTPUTS	
1	NULL 1	1	MON L
2	NULL 2	2	MON R
3	MIC/LINE/Hi-Z 1	3	LINE 1
4	MIC/LINE/Hi-Z 2	4	LINE 2
5	MIC/LINE 3	5	LINE 3
6	MIC/LINE 4	6	LINE 4
7	LINE 5	7	LINE 5
8	LINE 6	8	LINE 6
9	LINE 7	9	LINE 7
10	LINE 8	10	LINE 8
11	ADAT 1	11	ADAT 1
12	ADAT 2	12	ADAT 2
13	ADAT 3	13	ADAT 3
14	ADAT 4	14	ADAT 4
15	S/PDIF L	15	S/PDIF L
16	S/PDIF R	16	S/PDIF R
17	MON L*	17	HP1 L
18	MON R*	18	HP1 R
19	HP1 L*		
20	HP1 R*		
<i>*Software Outputs (for DAW inputs)</i>			

Apollo I/O, Multi-Unit, PT Mode Off

Apollo Driver I/O List Multi-Unit – PT Mode Off							
INPUTS				OUTPUTS			
MONITOR UNIT		EXPANDER UNIT		MONITOR UNIT		EXPANDER UNIT	
1	MIC/LINE/Hi-Z 1	23	2 MIC/LINE/Hi-Z 1	1	MON L	29	2 LINE 1
2	MIC/LINE/Hi-Z 2	24	2 MIC/LINE/Hi-Z 2	2	MON R	30	2 LINE 2
3	MIC/LINE 3	25	2 MIC/LINE 3	3	LINE 1	31	2 LINE 3
4	MIC/LINE 4	26	2 MIC/LINE 4	4	LINE 2	32	2 LINE 4
5	LINE 5	27	2 LINE 5	5	LINE 3	33	2 LINE 5
6	LINE 6	28	2 LINE 6	6	LINE 4	34	2 LINE 6
7	LINE 7	29	2 LINE 7	7	LINE 5	35	2 LINE 7
8	LINE 8	30	2 LINE 8	8	LINE 6	36	2 LINE 8
9	S/PDIF L	31	2 ADAT 1	9	LINE 7	37	2 S/PDIF L
10	S/PDIF R	32	2 ADAT 2	10	LINE 8	38	2 S/PDIF R
11	VIRTUAL 1*	33	2 ADAT 3	11	ADAT 1	39	2 VIRTUAL 1*
12	VIRTUAL 2*	34	2 ADAT 4	12	ADAT 2	40	2 VIRTUAL 2*
13	VIRTUAL 3*	35	2 ADAT 5	13	ADAT 3	41	2 VIRTUAL 3*
14	VIRTUAL 4*	36	2 ADAT 6	14	ADAT 4	42	2 VIRTUAL 4*
15	MON L*	37	2 ADAT 7	15	ADAT 5		
16	MON R*	38	2 ADAT 8	16	ADAT 6		
17	AUX1 L*	39	2 S/PDIF L	17	ADAT 7		
18	AUX1 R*	40	2 S/PDIF R	18	ADAT 8		
19	HP1 L*	41	2 VIRTUAL 1*	19	S/PDIF L		
20	HP1 R*	42	2 VIRTUAL 2*	20	S/PDIF R		
21	HP2 L*	43	2 VIRTUAL 3*	21	VIRTUAL 1*		
22	HP2 R*	44	2 VIRTUAL 4*	22	VIRTUAL 2*		
				23	VIRTUAL 3*		
				24	VIRTUAL 4*		
				25	HP1 L*		
				26	HP1 R*		
				27	HP2 L*		
				28	HP2 R*		
*Software Outputs (for DAW inputs)				*Software Inputs (for Console inputs)			

Apollo I/O, Multi-Unit, PT Mode On

Apollo Driver I/O List Multi-Unit – PT Mode On							
INPUTS			OUTPUTS				
MONITOR UNIT		EXPANDER UNIT		MONITOR UNIT		EXPANDER UNIT	
1	NULL 1	17	2 MIC/LINE/Hi-Z 1	1	MON L	21	2 LINE 1
2	NULL 2	18	2 MIC/LINE/Hi-Z 2	2	MON R	22	2 LINE 2
3	MIC/LINE/Hi-Z 1	19	2 MIC/LINE 3	3	LINE 1	23	2 LINE 3
4	MIC/LINE/Hi-Z 2	20	2 MIC/LINE 4	4	LINE 2	24	2 LINE 4
5	MIC/LINE 3	21	2 LINE 5	5	LINE 3	25	2 LINE 5
6	MIC/LINE 4	22	2 LINE 6	6	LINE 4	26	2 LINE 6
7	LINE 5	23	2 LINE 7	7	LINE 5	27	2 LINE 7
8	LINE 6	24	2 LINE 8	8	LINE 6	28	2 LINE 8
9	LINE 7	25	2 ADAT 1	9	LINE 7	29	2 S/PDIF L
10	LINE 8	26	2 ADAT 2	10	LINE 8	30	2 S/PDIF R
11	S/PDIF L	27	2 ADAT 3	11	ADAT 1	31	2 VIRTUAL 1*
12	S/PDIF R	28	2 ADAT 4	12	ADAT 2	32	2 VIRTUAL 2*
13	MON L*	29	2 ADAT 5	13	ADAT 3	33	(2 VIRTUAL 3*)
14	MON R*	30	2 ADAT 6	14	ADAT 4	34	(2 VIRTUAL 4*)
15	HP1 L*	31	2 ADAT 7	15	ADAT 5		
16	HP1 R*	32	2 ADAT 8	16	ADAT 6		
		33	(2 S/PDIF L)	17	ADAT 7		
		34	(2 S/PDIF R)	18	ADAT 8		
		35	(2 VIRTUAL 1*)	19	S/PDIF L		
		36	(2 VIRTUAL 2*)	20	S/PDIF R		
		37	(2 VIRTUAL 3*)				
		38	(2 VIRTUAL 4*)				
*Software Outputs (for DAW inputs)				*Software Inputs (for Console inputs)			
<i>Channel numbers above 32 (those in italics within parentheses) are unavailable in Pro Tools</i>							

Apollo 16 I/O, Single Unit, PT Mode Off

Apollo 16 Driver I/O List Single Unit – PT Mode Off			
INPUTS		OUTPUTS	
1	LINE 1	1	MON L
2	LINE 2	2	MON R
3	LINE 3	3	LINE 1
4	LINE 4	4	LINE 2
5	LINE 5	5	LINE 3
6	LINE 6	6	LINE 4
7	LINE 7	7	LINE 5
8	LINE 8	8	LINE 6
9	LINE 9	9	LINE 7
10	LINE 10	10	LINE 8
11	LINE 11	11	LINE 9
12	LINE 12	12	LINE 10
13	LINE 13	13	LINE 11
14	LINE 14	14	LINE 12
15	LINE 15	15	LINE 13
16	LINE 16	16	LINE 14
17	AES/EBU L	17	LINE 15
18	AES/EBU R	18	LINE 16
19	VIRTUAL 1*	19	AES/EBU L
20	VIRTUAL 2*	20	AES/EBU R
21	VIRTUAL 3*	21	VIRTUAL 1*
22	VIRTUAL 4*	22	VIRTUAL 2*
23	VIRTUAL 5*	23	VIRTUAL 3*
24	VIRTUAL 6*	24	VIRTUAL 4*
25	VIRTUAL 7*	25	VIRTUAL 5*
26	VIRTUAL 8*	26	VIRTUAL 6*
27	MON L*	27	VIRTUAL 7*
28	MON R*	28	VIRTUAL 8*
29	AUX1 L*	29	CUE 1 L
30	AUX1 R*	30	CUE 1 R
31	AUX2 L*	31	CUE 2 L
32	AUX2 R*	32	CUE 2 R
<i>*Software Outputs (for DAW inputs)</i>		<i>*Software Inputs (for Console inputs)</i>	

Apollo 16 I/O, Single Unit, PT Mode On

Apollo 16 Driver I/O List Single Unit – PT Mode On			
INPUTS		OUTPUTS	
1	NULL 1	1	MON L
2	NULL 2	2	MON R
3	LINE 1	3	LINE 1
4	LINE 2	4	LINE 2
5	LINE 3	5	LINE 3
6	LINE 4	6	LINE 4
7	LINE 5	7	LINE 5
8	LINE 6	8	LINE 6
9	LINE 7	9	LINE 7
10	LINE 8	10	LINE 8
11	LINE 9	11	LINE 9
12	LINE 10	12	LINE 10
13	LINE 11	13	LINE 11
14	LINE 12	14	LINE 12
15	LINE 13	15	LINE 13
16	LINE 14	16	LINE 14
17	LINE 15	17	LINE 15
18	LINE 16	18	LINE 16
19	AES/EBU L	19	AES/EBU L
20	AES/EBU R	20	AES/EBU R
21	VIRTUAL 1*	21	VIRTUAL 1*
22	VIRTUAL 2*	22	VIRTUAL 2*
23	VIRTUAL 3*	23	VIRTUAL 3*
24	VIRTUAL 4*	24	VIRTUAL 4*
25	VIRTUAL 5*	25	VIRTUAL 5*
26	VIRTUAL 6*	26	VIRTUAL 6*
27	MON L*	27	VIRTUAL 7*
28	MON R*	28	VIRTUAL 8*
29	AUX1 L*	29	CUE 1 L
30	AUX1 R*	30	CUE 1 R
31	AUX2 L*	31	CUE 2 L
32	AUX2 R*	32	CUE 2 R
<i>*Software Outputs (for DAW inputs)</i>		<i>*Software Inputs (for Console inputs)</i>	

Apollo 16 I/O, Single Unit, PT Mode Off, 4x Sample Rates

Apollo 16 Driver I/O List Single Unit – PT Mode Off 176.4 kHz & 192 kHz Sample Rates			
INPUTS		OUTPUTS	
1	LINE 1	1	MON L
2	LINE 2	2	MON R
3	LINE 3	3	LINE 1
4	LINE 4	4	LINE 2
5	LINE 5	5	LINE 3
6	LINE 6	6	LINE 4
7	LINE 7	7	LINE 5
8	LINE 8	8	LINE 6
9	LINE 9	9	LINE 7
10	LINE 10	10	LINE 8
11	LINE 11	11	LINE 9
12	LINE 12	12	LINE 10
13	AES/EBU L	13	LINE 11
14	AES/EBU R	14	LINE 12
15	MON L*	15	LINE 13
16	MON R*	16	LINE 14
17	AUX1 L*	17	LINE 15
18	AUX1 R*	18	LINE 16
		19	AES/EBU L
		20	AES/EBU R
		21	CUE 1 L
		22	CUE 1 R
		23	CUE 2 L
		24	CUE 2 R
*Software Outputs (for DAW inputs)			

Apollo 16 I/O, Single Unit, PT Mode On, 4x Sample Rates

Apollo 16 Driver I/O List Single Unit – PT Mode On 176.4 kHz & 192 kHz Sample Rates			
INPUTS		OUTPUTS	
1	NULL 1	1	MON L
2	NULL 2	2	MON R
3	LINE 1	3	LINE 1
4	LINE 2	4	LINE 2
5	LINE 3	5	LINE 3
6	LINE 4	6	LINE 4
7	LINE 5	7	LINE 5
8	LINE 6	8	LINE 6
9	LINE 7	9	LINE 7
10	LINE 8	10	LINE 8
11	LINE 9	11	LINE 9
12	LINE 10	12	LINE 10
13	LINE 11	13	LINE 11
14	LINE 12	14	LINE 12
15	AES/EBU L	15	LINE 13
16	AES/EBU R	16	LINE 14
17	MON L*	17	LINE 15
18	MON R*	18	LINE 16
19	AUX1 L*	19	AES/EBU L
20	AUX1 R*	20	AES/EBU R
		21	CUE 1 L
		22	CUE 1 R
		23	CUE 2 L
		24	CUE 2 R
*Software Outputs (for DAW inputs)			

Apollo 16 I/O, Multi-Unit, PT Mode Off

Apollo 16 Driver I/O List Multi-Unit – PT Mode Off							
INPUTS			OUTPUTS				
MONITOR UNIT		EXPANDER UNIT		MONITOR UNIT		EXPANDER UNIT	
1	LINE 1	33	2 LINE 1	1	MON L	33	2 LINE 1
2	LINE 2	34	2 LINE 2	2	MON R	34	2 LINE 2
3	LINE 3	35	2 LINE 3	3	LINE 1	35	2 LINE 3
4	LINE 4	36	2 LINE 4	4	LINE 2	36	2 LINE 4
5	LINE 5	37	2 LINE 5	5	LINE 3	37	2 LINE 5
6	LINE 6	38	2 LINE 6	6	LINE 4	38	2 LINE 6
7	LINE 7	39	2 LINE 7	7	LINE 5	39	2 LINE 7
8	LINE 8	40	2 LINE 8	8	LINE 6	40	2 LINE 8
9	LINE 9	41	2 LINE 9	9	LINE 7	41	2 LINE 9
10	LINE 10	42	2 LINE 10	10	LINE 8	42	2 LINE 10
11	LINE 11	43	2 LINE 11	11	LINE 9	43	2 LINE 11
12	LINE 12	44	2 LINE 12	12	LINE 10	44	2 LINE 12
13	LINE 13	45	2 LINE 13	13	LINE 11	45	2 LINE 13
14	LINE 14	46	2 LINE 14	14	LINE 12	46	2 LINE 14
15	LINE 15	47	2 LINE 15	15	LINE 13	47	2 LINE 15
16	LINE 16	48	2 LINE 16	16	LINE 14	48	2 LINE 16
17	AES/EBU L	49	2 AES/EBU L	17	LINE 15	49	2 AES/EBU L
18	AES/EBU R	50	2 AES/EBU R	18	LINE 16	50	2 AES/EBU R
19	VIRTUAL 1*	51	2 VIRTUAL 1*	19	AES/EBU L	51	2 VIRTUAL 1*
20	VIRTUAL 2*	52	2 VIRTUAL 2*	20	AES/EBU R	52	2 VIRTUAL 2*
21	VIRTUAL 3*	53	2 VIRTUAL 3*	21	VIRTUAL 1*	53	2 VIRTUAL 3*
22	VIRTUAL 4*	54	2 VIRTUAL 4*	22	VIRTUAL 2*	54	2 VIRTUAL 4*
23	VIRTUAL 5*	55	2 VIRTUAL 5*	23	VIRTUAL 3*	55	2 VIRTUAL 5*
24	VIRTUAL 6*	56	2 VIRTUAL 6*	24	VIRTUAL 4*	56	2 VIRTUAL 6*
25	VIRTUAL 7*	57	2 VIRTUAL 7*	25	VIRTUAL 5*	57	2 VIRTUAL 7*
26	VIRTUAL 8*	58	2 VIRTUAL 8*	26	VIRTUAL 6*	58	2 VIRTUAL 8*
27	MON L*			27	VIRTUAL 7*		
28	MON R*			28	VIRTUAL 8*		
29	AUX1 L*			29	CUE 1 L		
30	AUX1 R*			30	CUE 1 R		
31	AUX2 L*			31	CUE 2 L		
32	AUX2 R*			32	CUE 2 R		
*Software Outputs (for DAW inputs)				*Software Inputs (for Console inputs)			

Apollo 16 I/O, Multi-Unit, PT Mode On

Apollo 16 Driver I/O List Multi-Unit – PT Mode On							
INPUTS			OUTPUTS				
MONITOR UNIT		EXPANDER UNIT		MONITOR UNIT		EXPANDER UNIT	
1	NULL 1	19	2 LINE 1	1	MON L	19	2 LINE 1
2	NULL 2	20	2 LINE 2	2	MON R	20	2 LINE 2
3	LINE 1	21	2 LINE 3	3	LINE 1	21	2 LINE 3
4	LINE 2	22	2 LINE 4	4	LINE 2	22	2 LINE 4
5	LINE 3	23	2 LINE 5	5	LINE 3	23	2 LINE 5
6	LINE 4	24	2 LINE 6	6	LINE 4	24	2 LINE 6
7	LINE 5	25	2 LINE 7	7	LINE 5	25	2 LINE 7
8	LINE 6	26	2 LINE 8	8	LINE 6	26	2 LINE 8
9	LINE 7	27	2 LINE 9	9	LINE 7	27	2 LINE 9
10	LINE 8	28	2 LINE 10	10	LINE 8	28	2 LINE 10
11	LINE 9	29	2 LINE 11	11	LINE 9	29	2 LINE 11
12	LINE 10	30	2 LINE 12	12	LINE 10	30	2 LINE 12
13	LINE 11	31	2 LINE 13	13	LINE 11	31	2 LINE 13
14	LINE 12	32	2 LINE 14	14	LINE 12	32	2 LINE 14
15	LINE 13	33	<i>(2 LINE 15)</i>	15	LINE 13	33	<i>(2 LINE 15)</i>
16	LINE 14	34	<i>(2 LINE 16)</i>	16	LINE 14	34	<i>(2 LINE 16)</i>
17	LINE 15	35	<i>(2 AES/EBU L)</i>	17	LINE 15	35	<i>(2 AES/EBU L)</i>
18	LINE 16	36	<i>(2 AES/EBU R)</i>	18	LINE 16	36	<i>(2 AES/EBU R)</i>
		37	<i>(2 VIRTUAL 1*)</i>			37	<i>(2 VIRTUAL 1*)</i>
		38	<i>(2 VIRTUAL 2*)</i>			38	<i>(2 VIRTUAL 2*)</i>
		39	<i>(2 VIRTUAL 3*)</i>			39	<i>(2 VIRTUAL 3*)</i>
		40	<i>(2 VIRTUAL 4*)</i>			40	<i>(2 VIRTUAL 4*)</i>
		41	<i>(2 VIRTUAL 5*)</i>			41	<i>(2 VIRTUAL 5*)</i>
		42	<i>(2 VIRTUAL 6*)</i>			42	<i>(2 VIRTUAL 6*)</i>
		43	<i>(2 VIRTUAL 7*)</i>			43	<i>(2 VIRTUAL 7*)</i>
		44	<i>(2 VIRTUAL 8*)</i>			44	<i>(2 VIRTUAL 8*)</i>
*Software Outputs (for DAW inputs)				*Software Inputs (for Console inputs)			
<i>Channel numbers above 32 (those in italics within parentheses) are unavailable within Pro Tools</i>							

Chapter 10: Glossary

A/D An acronym for “Analog to Digital,” which refers to the conversion of analog signals to digital data.

Acronym A word formed from the first letters of other words (e.g., GUI, ADAT, TRS, etc.).

ADAT An acronym for “Alesis Digital Audio Tape.” ADAT was the name given to the Alesis-branded products of the 1990s which recorded eight tracks of digital audio on a standard S-VHS video cassette. The term now generally refers to the 8-channel optical “Lightpipe” connection that is used in a wide range of digital products from many manufacturers.

AES (sometimes written as “AES/EBU”) The name of a digital audio transfer standard jointly developed by the American-based Audio Engineering Society and the European Broadcast Union. Designed to carry two channels of 16-, 20- or, 24-bit digital audio at sampling rates of up to 192kHz, the most common AES physical interconnect utilizes a 3-conductor 110 ohm twisted pair cable, terminating at standard XLR connectors. (See “Dual Wire” and “Single Wire”)

Analog Literally, an analog is a replica or representation of something. In audio signals, changes in voltage are used to represent changes in acoustic sound pressure. Note that analog audio is a continuous representation, as opposed to the quantized, or discrete “stepped” representation created by digital devices. (See “Digital”)

API Acronym for Application Programming Interface. A software layer between an operating system and third-party hardware (such as an audio interface) and/or software (such as a DAW). For example, a computer OS’s audio API enables audio hardware and audio software from different vendors to communicate with the OS and each other.

ASIO Acronym for Audio Stream Input/Output. ASIO is an audio interface driver protocol for Windows operating systems developed by Steinberg GmbH.

Balanced Audio cabling that uses two twisted conductors enclosed in a single shield, thus allowing relatively long cable runs with minimal signal loss and reduced induced noise such as hum.

Bit A contraction of the words “binary” and “digit,” a bit is a number used in a digital system, and it can have only one of two values: 0 or 1. The number of bits in each sample determines the theoretical maximum dynamic range of the audio data, regardless of sample rate being used. Each additional bit adds approximately 6 dB to the dynamic range of the audio. In addition, the use of more bits helps capture quieter signal more accurately. (See “Sample” and “Dynamic range”)

Bit Depth (See “Bit Resolution”)

Bit Resolution Often used interchangeably with “bit depth,” this is a term used to describe the number of bits used in a digital recording. Apollo converts analog audio and transmits digital audio with a resolution of 24 bits (thus yielding a theoretical dynamic range of approximately 145 dB), the highest audio interface resolution in common use today. (See “Dynamic Range”)

BNC A bayonet-type coaxial connector often found on video and digital audio equipment, as well as on test devices like oscilloscopes. In digital audio equipment, BNC connectors are normally used to carry word clock signals between devices. BNC connectors are named for their type (Bayonet), and their inventors, Paul Neil and Carl Concelman. (See “Word Clock”)

Buffer, buffers, buffering The transference of data in small batches instead of continuously. Buffering induces latency (delay) and is inherent in most digital audio systems.

Bus A signal path that carries more than one signal, e.g., a mix bus, auxiliary bus, headphone bus, etc.

Channel Input Strip A group of controls that pertain only to the functions contained within a particular mixer input channel. In most mixing consoles, the “strips” are duplicated for each input.

Class A One design technique used in electronic devices such that their active components are drawing current and working throughout the full signal cycle, thus yielding a more linear response. This increased linearity results in fewer harmonics generated, hence lower distortion in the output signal.

Condenser Microphone A microphone design that utilizes an electrically charged thin conductive diaphragm stretched close to a metal disk called a backplate. Incoming sound pressure causes the diaphragm to vibrate, in turn causing the capacitance to vary in a like manner, which causes a variance in its output voltage. Condenser microphones tend to have excellent transient response but require an external voltage source, most often in the form of 48 volts of “phantom power.”

Clock In digital audio or video, a clock serves as a timing reference for a system. Every digital device must carry out specified numbers of operations per period of time and at a consistent speed in order for the device to work properly. Digital audio devices such as Apollo normally have an internal clock, and are also capable of locking to external clock routed from other digital devices. In order to avoid signal degradation or undesirable audible artifacts, it is absolutely critical that all digital devices that are interconnected in a system be locked to the same clock.

Clock Distribution Refers to the process of routing a master clock signal (either from an internal clock or an external source) to multiple devices by means of multiple outputs, thus removing the need to cascade the clock through external devices, which can degrade the signal.

Core Audio The audio [API](#) for Mac OS X.

D/A Acronym for “Digital to Analog,” which refers to the conversion of a digital data to an analog signal.

DAW Acronym for “Digital Audio Workstation” – that is, any device that can record, play back, edit, and process digital audio.

dB Abbreviation for “decibel,” a logarithmic unit of measure used to determine, among other things, power ratios, voltage gain, and sound pressure levels.

dBm Abbreviation for “decibels as referenced to milliwatt,” dissipated in a standard load of 600 ohms. 1 dBm into 600 ohms results in 0.775 volts RMS.

dBV Abbreviation for “decibels as referenced to voltage,” without regard for impedance; thus, one volt equals one dBV.

DI Acronym for “Direct Inject” or “Direct Input,” a recording technique whereby the signal from a high-impedance instrument such as electric guitar or bass is routed to an input. DI into mixer or tape recorder inputs often employ use of a “DI box,” which raises the signal to the correct voltage level at the right impedance.

Digital Information or data that is stored or communicated as a series of bits (binary digits, with values of 0 or 1). Digital audio refers to the representation of varying sound pressure levels by means of a series of numbers. (See “Analog” and “Bit”)

Dither Minute amounts of shaped noise added intentionally to a digital recording in order to reduce a form of distortion known as “quantization noise” and aid in low level sound resolution.

Dry Refers to a signal that is unprocessed, e.g., recording a dry signal. The antonym of a “wet” signal.

DSP Acronym for “Digital Signal Processing” (or “Digital Signal Processor.”)

DSP Accelerator A device dedicated to digital signal processing. UAD-2 devices are DSP accelerators.

Dynamic Microphone A type of microphone that generates signal with the use of a very thin, light diaphragm which moves in response to sound pressure. That motion in turn causes a voice coil which is suspended in a magnetic field to move, generating a small electric current. Dynamic mics are generally less expensive than condenser or ribbon mics and do not require external power to operate.

Dynamic Range The difference between the loudest sections of a piece of music and the softest ones. The dynamic range of human hearing (that is, the difference between the very softest passages we can discern and the very loudest ones we can tolerate) is considered to be approximately 120 dB. (See “Bit resolution”)

EQ Abbreviation for “Equalization,” a circuit that allows selected frequency areas in an audio signal to be attenuated or boosted.

External Clock A clock signal derived from an external source. (See “Clock”)

FET Acronym for “Field Effect Transistor.” A type of transistor that relies on an electric field to control the shape, and hence the conductivity, of a “channel” in a semiconductor material.

Firmware Software that is embedded in hardware.

Flex Routing Apollo technology that enables its physical inputs to be routed to various physical outputs. Compare to Virtual I/O.

FPGA Acronym for “Field Programmable Gate Array.” A type of integrated circuit that can be programmed after manufacturing (“in the field”) to perform specialized functions.

Front End Refers to a device that provides analog and digital input/output (I/O) to a digital audio workstation (DAW). Apollo is a front end.

Graphical User Interface A software window, panel, or screen containing controls where parameters are adjusted by the user. (See “GUI”)

GUI Acronym for Graphical User Interface.

Hi-Z Abbreviation for “High Impedance.” Apollo’s Hi-Z input allows direct connection of an instrument such as electric guitar or bass via a standard unbalanced ¼” jack.

High Resolution In digital audio, refers to 24-bit signals at sampling rates of 88.2 kHz or higher.

Hz Abbreviation for “Hertz,” a unit of measurement describing a single analog audio cycle (or digital sample) per second.

Impedance A description of a circuit’s resistance to a signal, as measured in ohms, thousands of ohms (Kilohms), or millions of ohms (megohms).

Internal Clock A clock signal derived from onboard circuitry. (See “Clock”)

I/O Acronym for “input/output.”

kHz Abbreviation for “kiloHertz” (a thousand Hertz), a unit of measurement describing a thousand analog audio cycles (or digital samples) per second. (See “Hz”)

JFET Acronym for Junction Field Effect Transistor, a specific type of FET which has some similarities to traditional bipolar transistor designs that can make it more appropriate for use in some audio circuit designs. (See “FET”)

Jitter Refers to short-term variations in the edges of a clock signal, caused by a bad source clock, inferior cabling or improper cable termination, and/or signal-induced noise. A jittery signal will contain spurious tones at random, inharmonic frequencies. Usually, the jitter will be worse with higher signal frequencies. The internal digital clock of Apollo was designed for extreme stability and jitter-free operation, and its onboard phase aligned clock conditioner circuitry removes jitter from external sources, so conversion quality is unaffected by clock source.

Lightpipe A digital connection made with optical cable. This was a phrase coined by Alesis to make a distinction between the proprietary 8-channel optical network used in their ADAT products and standard stereo optical connectors used on CD players and other consumer products.

Line Level Refers to the voltages used by audio devices such as mixers, signal processors, tape recorders, and DAWs. Professional audio systems typically utilize line level signals of +4 dBm (which translates to 1.23 volts), while consumer and semiprofessional audio equipment typically utilize line level signals of -10 dBV (which translates to 0.316 volts).

Low Cut Filter An equalizer circuit that cuts signal below a particular frequency. Same as “high pass filter.”

Mic Level Refers to the very low level signal output from microphones, typically around 2 millivolts (2 thousandths of a volt).

Mic Preamp The output level of microphones is very low and therefore requires specially designed mic preamplifiers to raise (amplify) their level to that needed by a mixing console, tape recorder, or digital audio workstation (DAW).

Mute “Turn off the signal.” Mute stops the signal from being routed.

Native Refers to computer-based digital audio recording software controlled by the computer’s onboard processor, as opposed to software that requires external hardware to run.

OS Acronym for Operating System. The OS is the software used to control the computer hardware, such as OS X (Mac) and Windows (PC).

Pan Abbreviation for “Panorama” or “Panoramic.” A pan control determines a monophonic signal’s positioning in the stereo field.

Patch Bay A passive, central routing station for audio signals. In most recording studios, the line-level inputs and outputs of all devices are connected to a patch bay, making it an easy matter to re-route signal with the use of patch cords.

Patch Cord A short audio cable with connectors on each end, typically used to interconnect components wired to a patch bay.

PDF Acronym for “Portable Document Format.” PDF is the standardized file format used for distribution of documentation in electronic form. Various applications can open PDF files; one such “reader” application is available for free at www.adobe.com.

Plug-In Software components that are added to host software applications to enhance their functionality and/or performance.

Powered Plug-Ins High-quality audio processing plug-ins, developed and sold by Universal Audio, that run exclusively on UAD DSP accelerator products.

Quantization Noise A form of digital distortion caused by mathematical rounding-off errors in the analog to digital conversion process. Quantization noise can be reduced dramatically by dithering the digital signal. (See “Dither”)

Realtime UAD Processing Universal Audio's DSP + FPGA technology that enables UAD Powered Plug-Ins to run with latencies in the sub-2ms range. Realtime UAD processing provides the ultimate sonic experience while monitoring and/or tracking. Realtime UAD processing is a special function that is available only within the Console application.

Ribbon Microphone A type of microphone that works by loosely suspending a small element (usually a corrugated strip of metal) in a strong magnetic field. This "ribbon" is moved by the motion of air molecules and in doing so it cuts across the magnetic lines of flux, causing an electrical signal to be generated. Ribbon microphones tend to be delicate and somewhat expensive, but often have very flat frequency response.

Sample A digital "snapshot" of the amplitude of a sound at a single instant in time. The number of samples taken per second is determined by the device's sample rate. (See "Sample rate")

Sample Rate The number of samples per second. In digital audio, there are six commonly used sample rates: 44.1 kHz (used by audio CDs), 48 kHz, 88.2 kHz (2 x 44.1 kHz), 96 kHz (2 x 48 kHz, used by DVDs), 176.4 kHz (4 x 44.1 kHz), and 192 kHz (4 x 48 kHz). The higher the sample rate, the greater the frequency response of the resulting signal; however, higher sample rates require more storage space. (See "kHz")

Sample Rate Conversion The process of altering a digital signal's sample rate to a different sample rate.

S/MUX (sometimes written as "S-MUX") Abbreviation for Sample Multiplexing. S/MUX is a method for transmitting two channels of high sample rate (88.2, 96, 176.4, or 192 kHz) 24-bit digital audio over a legacy optical "lightpipe" ADAT connection, which was originally designed to carry eight channels of 16-, 20- or 24-bit audio at 44.1 kHz or 48 kHz sampling rate. (See "ADAT" and "Lightpipe")

SPDIF (sometimes written as "S/PDIF") An acronym for "Sony/Philips Digital Interface Format," a digital audio transfer standard largely based on the AES/EBU standard. Designed to carry two channels of 16-, 20- or 24-bit digital audio at sampling rates of up to 192 kHz, the most common SPDIF physical interconnect utilizes unbalanced, 75 ohm video-type coaxial cables terminating at phono (RCA-type) connectors. (See "AES")

Superclock A proprietary format used by some early Pro Tools systems to distribute clock signal running at 256x the system's sample rate, thus matching the internal timing resolution of the software. (See "Clock" and "Pro Tools")

Transcoding Converting one type of digital signal to another (i.e, from AES to SPDIF, or from ADAT to AES).

Transformer An electronic component consisting of two or more coils of wire wound on a common core of magnetically permeable material. Audio transformers operate on audible signal and are designed to step voltages up and down and to send signal between microphones and line-level devices such as mixing consoles, recorders, and DAWs.

Transient A relatively high volume pitchless sound impulse of extremely brief duration, such as a pop. Consonants in singing and speech, and the attacks of musical instruments (particularly percussive instruments), are examples of transients.

Transimpedance Preamp A transformerless solid-state preamplifier utilizing a transistor configuration that employs current feedback for ultra-low distortion and the highest possible quality of signal from input to output. The transimpedance design allows audio from 4 Hz to 150 kHz to pass through without altering the phase relationships between fundamental frequencies and overtones. Noise and distortion are kept to near-theoretical minimums so critical signals may be generously amplified without degrading the quality or character of the sound source.

TRS Acronym for Tip-Ring-Sleeve. A ¼” phone connector with three conductors, typically used for balanced signal connections (e.g., I/O) or carrying two unbalanced signals (e.g., headphones).

TS Acronym for Tip-Sleeve. A ¼” phone connector with two conductors, typically used for unbalanced signal connections. Note that TS, like TRS and XLR, denotes the connector only and does not necessarily indicate the signal level of the connection. TS/TRS/XLR cables are used for both low-level (e.g., microphones and instruments) and line-level connections.

UAD Acronym for “Universal Audio Digital.” Used in reference to digital products created by Universal Audio.

UAD-2 A line of DSP accelerator products developed and manufactured by Universal Audio.

Unison Universal Audio’s exclusive preamp hardware/software integration technology that enables UAD preamp plug-ins reconfigure the physical input impedance, gain staging response, and other parameters of Apollo’s mic preamp hardware to match the emulated preamp’s hardware design characteristics with bi-direction control.

Virtual I/O Apollo audio inputs and outputs that exist in software but not in hardware. Virtual I/O is used to route digital audio channels between Console and other audio applications. Compare to Flex Routing.

Wet Refers to a signal that is processed, e.g., recording a wet signal. The antonym of a “dry” signal.

Word Clock A dedicated clock signal based on the transmitting device’s sample rate or the speed with which sample words are sent over a digital connection. (See “Clock”)

XLR A standard three-pin connector used by many audio devices, with pin 1 typically connected to the shield of the cabling, thus providing ground. Pins 2 and 3 are used to carry audio signal, normally in a balanced (out of phase) configuration.

Chapter 11: Index

Symbols

48V 28

A

Accessing Apollo I/O via Core Audio 88
Accessing Apollo's I/O 93
Always On Top 61
Apollo as a digital mixer (without a DAW) 85
Apollo as an Audio Interface 88
Apollo Concurrently with a DAW and Console 95
Apollo Hardware Manual 7
Apollo I/O Driver Names 88
Apollo Setups Overview 85
Apollo System 4
Apollo with a DAW (without Console) 92
Apollo with Console (without a DAW) 90
Apollo Without A Computer 91
Audio Interface Latency 111
Automatic Delay Compensation in the DAW 108
Aux Fader 45
Aux Headphone Sends 43
Auxiliary Section 42
Auxiliary Sends 33
Aux Inserts 43
Aux Meter 45
Aux Mono 45
Aux Mute 45
Aux Output 44
Aux Return Control Strips 43

C

Channel Fader 38
Channel Strip Editor 32
Clear Peaks 52
Clip Hold Time 62
Clip & Peak Hold Settings 62
Clock Source 59
Close All Plug-In Editor Windows 66
Console Application 5, 9, 19
Console Controls 24
Console Mixer 23
Console Mixer Latency 111
Console Overview 19
Console Recall Controls 69
Console Recall Menu 53
Console Recall Overview 68
Console Recall Plug-In 9, 68
Console Settings Window 57
Core Audio 114
customer support 11

D

DAW Documentation 8
DAW Latency 112
Default Outputs 93
Delay Compensation 108
Device Drivers 6, 10, 108, 114
Driver Reporting 108
Drivers 114
Drivers Overview 114

F

Fader 39, 45
Fader Scale 39
Features 5
File Menu 64
Flex Routing 36

G

Gain 27
Global 52
Global Interface Settings 59
Glossary 128

H

Hardware installation 12
Hardware Manual 7
Hardware Monitoring 95
Headphone Master 48
Headphone Sends 43
Headphone Source 48
HPF 28

I

IDC 60
Identify 58
Input Controls 27
Input Delay Compensation 60, 108, 110
Input Mute 38
Input Solo 38
Input Strips 25
Input Types 25
Insert Disable 31
Insert Display 31
Insert Menu 31
Insert Options 32
Inserts 30
Interface Latency 111
Interface Settings 59
Interface Settings Panel 58
Introduction 4
I/O Buffer Size 112
I/O Driver Names 88
I/O in Mac OS X System Preferences 89
I/O in the audio software application 88

L

Label 40
Latency Compensation 96
Level Hover 39
Level Scale 40
Line Outputs 1 – 8 Reference Level 60
Link 29, 41
Link Limitations 41
Low Cut Filter 28

M

Meter 45
Meter Scale 51
Meter Source 51
Mic/Line 27
Minimize 62
Mirror to Monitor 37
MON 47
Monitor Global 52
Monitor Level 52
Monitor Meters 51
Monitor Mute 52
Monitor Source 51
Monitor With FX 47
Mono 45, 52
Multi-Unit Cascading 101
Mute 38, 45, 52

O

Outputs 93

P

Pad 28, 29
Pan 38
Peak Hold Settings 62
Peak Hold Time 62
phase 28
Polarity 28
Preamp Controls 27
Preamp Inputs 25
Pre-Fader 66
PT Mode 99

R

REC 47
Recall Menu 54
Record With FX 47
Redo 65
Reference Level 29
Routing Console Outputs Into the DAW for Recording 96

S

Sample Rate 59
Scrolling 24
Select Unit 58
Session Name 54
Settings 65
Shortcuts 24
Show Mixer Window 66
Show Plug-In Editor Windows 66
Software Features 5
Software Monitoring 95
Software Overview 9
Software Updates 8, 12
Solo 38
Solo Clear 52
Source 51
S/PDIF Mirrors Monitor 1–2 60
Standalone Use 91
Synchronized DAW Sessions 70
System Latency Overview 108

T

Technical Support 11
Tempo 62

U

UAD-2 DSP Latency 112
UAD Meter & Control Panel 6
UAD Mixer Engine 114
UAD Powered Plug-Ins 6, 9
UAD Powered Plug-Ins Processing 86
Undo 65
Unison 72
Upsampled UAD Plug-Ins 111
Using Apollo Concurrently with a DAW and Console 95
Using Apollo with a DAW (without Console) 92
Using Apollo with Console (without a DAW) 90

V

Virtual I/O 97

W

Window Menu 66
Window Title Bar 62

Chapter 12: Notices

Disclaimer

The information contained in this manual is subject to change without notice. Universal Audio, Inc. makes no warranties of any kind with regard to this manual, including, but not limited to, the implied warranties of merchantability and fitness for a particular purpose. Universal Audio, Inc. shall not be liable for errors contained herein or direct, indirect, special, incidental, or consequential damages in connection with the furnishing, performance, or use of this material.

End User License Agreement

Your rights to the Software are governed by the accompanying End User License Agreement, a copy of which can be found at: www.uaudio.com/eula

Trademarks

Universal Audio, the Universal Audio “diamond” logo, Apollo, Apollo Twin, Apollo 16, Unison technology, UAD, UAD Series, UAD-1, UAD-2, UAD-2 Satellite, Powered Plug-Ins, 1176LN, 1176SE, Teletronix, LA-2A, LA-3A, LA-610, LA-610MkII, 2-1176, 2-610, 6176, 710 Twin-Finity, 2192, 4-710d, Cambridge EQ, DreamVerb, Plate 140, Precision Limiter, RealVerb Pro, Precision Buss Compressor, Precision De-Esser, Precision Maximizer, and “Analog Ears | Digital Minds,” are among the trademarks, trade names, and service marks owned by UA that may appear on the Site, many of which are registered in the United States and other countries. This is not a comprehensive list of all UA trademarks. All UA trademarks inure to the benefit of UA. Other trademarks and trade names that may appear on the Site and which are not owned by UA are owned by the respective owners.

Copyright

Copyright ©2015 Universal Audio, Inc. All rights reserved.

This manual and any associated software, artwork, product designs, and design concepts are subject to copyright protection. No part of this document may be reproduced, in any form, without prior written permission of Universal Audio, Inc.

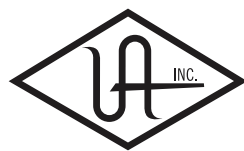

UNIVERSAL AUDIO

Universal Audio, Inc.
4585 Scotts Valley Drive
Scotts Valley, CA 95066 USA
Customer Service & Technical Support:
USA Toll-Free: +1-877-698-2834
International: +1-831-440-1176
www.uaudio.com