

EOS M3

Camera User Guide

- Make sure you read this guide, including the “Safety Precautions” (📖 13) section, before using the camera.
- Reading this guide will help you learn to use the camera properly.
- Store this guide so that you can conveniently access it in the future.

- Click the buttons in the lower right to access other pages.
 - ▶: Next page
 - ◀: Previous page
 - 🔄: Return to the page you were viewing when you clicked a link.
- To jump to the beginning of a chapter, click the chapter title at right.

Before Use

Basic Guide

Advanced Guide

1 Camera Basics

2 Auto Mode / Hybrid Auto Mode

3 Other Shooting Modes

4 P Mode

5 Tv, Av, M, and C Modes

6 Playback Mode

7 Wi-Fi Functions

8 Set-Up Menu

9 Accessories

10 Appendix

Index

ENGLISH



Before Use

Initial Information

Package Contents

Before use, make sure the following items are included in the package. If anything is missing, contact your camera retailer.

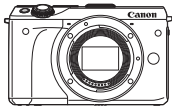

Camera
(with body cap)



Battery Pack
LP-E17
(with terminal cover)



Battery Charger
LC-E17/LC-E17E



Neck Strap
EM-200DB

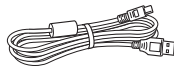

Interface Cable
IFC-400PCU

- Printed matter is also included.
- Check that the contents of the lens kit are included in the camera's package.
- A memory card is not included.

Compatible Memory Cards

The following memory cards (sold separately) can be used, regardless of capacity.

- SD memory cards*1
- SDHC memory cards *1*2
- SDXC memory cards*1*2 

*1 Cards conforming to SD standards. However, not all memory cards have been verified to work with the camera.

*2 UHS-I memory cards are also supported.

Preliminary Notes and Legal Information

- Take and review some test shots initially to make sure the images were recorded correctly. Please note that Canon Inc., its subsidiaries and affiliates, and its distributors are not liable for any consequential damages arising from any malfunction of a camera or accessory, including memory cards, that result in the failure of an image to be recorded or to be recorded in a way that is machine readable.
- Images recorded by the camera shall be for personal use. Refrain from unauthorized recording that infringes on copyright law, and note that even for personal use, photography may contravene copyright or other legal rights at some performances or exhibitions, or in some commercial settings.
- The camera warranty is valid only in the area of purchase. In case of camera problems while abroad, return to the area of purchase before contacting a Canon Customer Support Help Desk.
- Although the LCD monitor is produced under extremely high-precision manufacturing conditions and more than 99.99% of the pixels meet design specifications, in rare cases some pixels may be defective or may appear as red or black dots. This does not indicate camera damage or affect recorded images.
- The LCD monitor may be covered with a thin plastic film for protection against scratches during shipment. If covered, remove the film before using the camera.
- When the camera is used over an extended period, it may become warm. This is not a malfunction.

Before Use

Basic Guide

Advanced Guide

1 Camera Basics

2 Auto Mode / Hybrid Auto Mode

3 Other Shooting Modes

4 P Mode

5 Tv, Av, M, and C Modes

6 Playback Mode

7 Wi-Fi Functions

8 Set-Up Menu

9 Accessories

10 Appendix

Index



Part Names

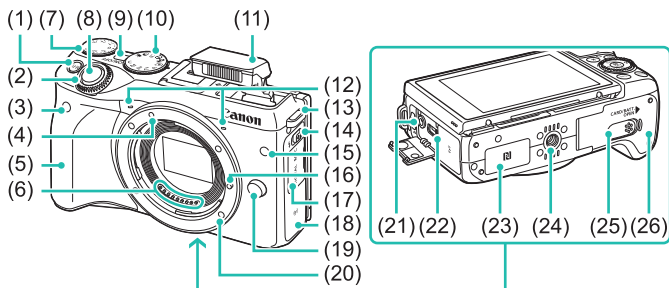

- | | |
|--|--|
| (1) M-Fn (Multifunction) button | (19) Lens release button |
| (2) Front dial | (20) Lens mount |
| (3) Remote control sensor | (21) External microphone IN terminal |
| (4) EF-M lens mount index | (22) Digital terminal |
| (5) Grip | (23) N (N-Mark)* |
| (6) Contacts | (24) Tripod socket |
| (7) Exposure compensation dial | (25) DC coupler terminal cover |
| (8) Shutter button | (26) Memory card slot / Battery pack compartment cover |
| (9) Power button | |
| (10) Mode dial | * Used with NFC features (📖118). |
| (11) Flash | |
| (12) Microphone | |
| (13) Strap mount | |
| (14) ⚡ (Flash pop-up) switch | |
| (15) Lamp | |
| (16) Lens lock pin | |
| (17) Terminal cover | |
| (18) Wi-Fi antenna area | |

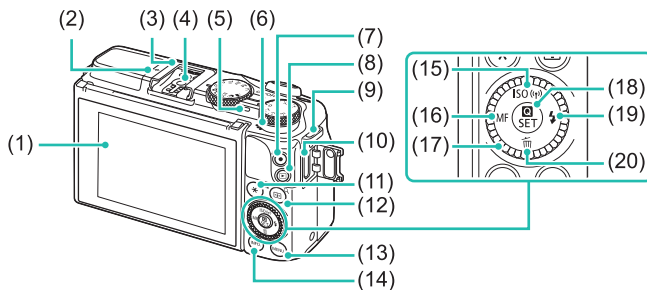

- | | |
|---|---|
| (1) LCD monitor / Touch screen* | (12) [AF Frame adjustment] / [Q (Magnify)] button |
| (2) ⊖ Focal plane mark | (13) MENU (Menu) button |
| (3) Hot shoe | (14) INFO. (Information) button |
| (4) Flash sync contacts | (15) ISO (ISO speed) / [Wi-Fi] / Up button |
| (5) Indicator | (16) MF (Manual focus) / Left button |
| (6) Speaker | (17) Control dial |
| (7) Movie button | (18) [Quick setting menu] / Set button |
| (8) [Playback] button | (19) ⚡ (Flash) / Right button |
| (9) Strap mount | (20) [Erase] / Down button |
| (10) HDMI™ terminal | |
| (11) [AE lock] / [Index] button | |

* Touch may not be detected as easily if you apply a screen protector.

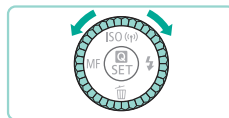

- Turning the control dial is one way to choose setting items, switch images, and perform other operations. Most of these operations are also possible with the **[▲]****[▼]****[◀]****[▶]** buttons.

Before Use

Basic Guide

Advanced Guide

1 Camera Basics

2 Auto Mode / Hybrid Auto Mode

3 Other Shooting Modes

4 P Mode

5 Tv, Av, M, and C Modes

6 Playback Mode

7 Wi-Fi Functions

8 Set-Up Menu

9 Accessories

10 Appendix

Index



Lens

EF-M Lens

(Lens with no focus mode switch or image stabilizer switch)

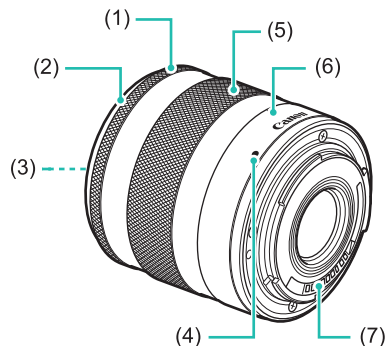

- (1) Focusing ring
- (2) Hood mount
- (3) Filter-mounting thread (front of lens)
- (4) Lens mount index
- (5) Zoom ring
- (6) Zoom position index
- (7) Contacts

Conventions Used in this Guide

- In this guide, icons are used to represent the corresponding camera buttons and dials on which they appear or which they resemble.
- The following camera buttons and controls are represented by icons.

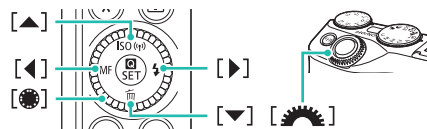

- Shooting modes and on-screen icons and text are indicated in brackets.
- ⓘ: Important information you should know
- ✎: Notes and tips for expert camera use
- ✎: Indicates touch-screen operations
- 📖xx: Pages with related information (in this example, “xx” represents a page number)
- Instructions in this guide apply to the camera under default settings.
- All lenses and mount adapters are referred to simply as “lenses” and “mount adapters”, regardless of whether they are included in the lens kit or sold separately.
- Illustrations in this manual show the camera with lens EF-M 18-55mm f/3.5-5.6 IS STM attached.
- For convenience, all supported memory cards are simply referred to as the “memory card”.
- The symbols “▶ Still Images” and “▶ Movies” below titles indicate how the function is used — whether for still images or movies.

Before Use

Basic Guide

Advanced Guide

1 Camera Basics

2 Auto Mode / Hybrid Auto Mode

3 Other Shooting Modes

4 P Mode

5 Tv, Av, M, and C Modes

6 Playback Mode

7 Wi-Fi Functions

8 Set-Up Menu

9 Accessories

10 Appendix

Index



Table of Contents

Before Use

Initial Information	2
Package Contents.....	2
Compatible Memory Cards.....	2
Preliminary Notes and Legal Information.....	2
Part Names.....	3
Lens.....	4
Conventions Used in this Guide.....	4
Common Camera Operations.....	12
Safety Precautions.....	13

Basic Guide

Basic Operations	16
Initial Preparations.....	16
Attaching the Strap.....	16
Charging the Battery Pack.....	16
Inserting the Battery Pack and Memory Card.....	17
Removing the Battery Pack and Memory Card.....	18
Setting the Date and Time.....	18
Changing the Date and Time.....	19
Display Language.....	20
Attaching a Lens.....	20
Detaching a Lens.....	21
Lens Instruction Manual.....	21
Attaching EF and EF-S Lenses.....	21
Detaching a Lens.....	22
Using a Tripod.....	22

Stabilizing the Image.....	22
Trying the Camera Out.....	23
Holding the Camera.....	23
Shooting in Scene Intelligent Auto Mode.....	23
Viewing.....	25
Erasing Images.....	26

Advanced Guide

1 Camera Basics	27
On/Off.....	27
Power-Saving Features (Auto Power Down).....	28
Power Saving in Shooting Mode.....	28
Power Saving in Playback Mode.....	28
Shutter Button.....	28
Shooting Modes.....	29
Adjusting the Angle of the LCD Monitor.....	29
Tilting the Screen Downward.....	29
Tilting the Screen Upward.....	29
Shooting Display Options.....	30
Using the Quick Setting Menu.....	31
Using Touch-Screen Operations to Configure Settings.....	31
Using the Menu Screen.....	32
Touch-Screen Operations.....	33
On-Screen Keyboard.....	33
Indicator Display.....	34
2 Auto Mode / Hybrid Auto Mode	35
Shooting with Camera-Determined Settings.....	35
Shooting (Scene Intelligent Auto).....	35
Shooting in Hybrid Auto Mode.....	37
Digest Movie Playback.....	37
Still Images/Movies.....	37

Before Use

Basic Guide

Advanced Guide

1 Camera Basics

2 Auto Mode / Hybrid Auto Mode

3 Other Shooting Modes

4 P Mode

5 Tv, Av, M, and C Modes

6 Playback Mode

7 Wi-Fi Functions

8 Set-Up Menu

9 Accessories

10 Appendix

Index



Still Images.....	38
Movies.....	38
Scene Icons.....	39
On-Screen Frames.....	40
Common, Convenient Features.....	40
Using the Self-Timer.....	40
Using the Self-Timer to Avoid Camera Shake.....	41
Shooting by Touching the Screen (Touch Shutter).....	41
Continuous Shooting.....	42
Image Customization Features.....	43
Changing Image Quality.....	43
Saving RAW Images.....	43
Using the Menu.....	44
Changing the Aspect Ratio.....	45
Changing Movie Image Quality.....	45
Using the Dual Axis Electronic Level.....	46
Customizing Camera Operation.....	47
Preventing the Red-Eye Reduction Lamp from Lighting Up.....	47
Changing the Image Display Period after Shots.....	47
3 Other Shooting Modes.....	48
Shooting with Your Favorite Settings (Creative Assist).....	48
Saving/Loading Settings.....	49
Saving Settings.....	49
Loading.....	50
Using Screen Settings.....	50
Playing Back Images.....	50
[★] Mode and Creative Zone Settings.....	50
Specific Scenes.....	51
Taking Vivid Pictures of Food (Food).....	52
Image Effects (Creative Filters).....	52
Shooting High-Contrast Scenes (High Dynamic Range).....	53

Adding Artistic Effects.....	53
Shooting with a Fish-Eye Lens Effect (Fish-Eye Effect).....	54
Shooting Oil Painting-like Photos (Art bold Effect).....	54
Shooting Watercolor-like Photos (Water Painting Effect).....	54
Shots Resembling Miniature Models (Miniature Effect).....	55
Playback Speed and Estimated Playback Time (for One-Minute Clips).....	55
Shooting with a Toy Camera Effect (Toy Camera Effect).....	56
Shooting with a Soft Focus Effect.....	56
Shooting in Monochrome (Grainy B/W).....	57
Shooting Movies in Movie Mode.....	57
Shooting Still Images during Movie Recording.....	58
Locking or Changing Image Brightness.....	58
Sound Settings.....	59
Adjusting the Recording Volume.....	59
Turning Off the Wind Filter.....	59
Using the Attenuator.....	59
4 P Mode.....	60
Shooting in Program AE ([P] Mode).....	60
Adjusting Shooting Functions from a Single Screen.....	61
Image Brightness (Exposure).....	61
Adjusting Image Brightness (Exposure Compensation).....	61
Locking Image Brightness / Exposure (AE Lock).....	61
Changing the Metering Method.....	62
Changing the ISO Speed.....	62
Adjusting ISO Auto Settings.....	63
Auto Exposure Bracketing (AEB Shooting).....	63
Auto Correction of Brightness and Contrast (Auto Lighting Optimizer).....	64
Shooting Bright Subjects (Highlight Tone Priority).....	64
Image Colors.....	65

Before Use

Basic Guide

Advanced Guide

1 Camera Basics

2 Auto Mode / Hybrid Auto Mode

3 Other Shooting Modes

4 P Mode

5 Tv, Av, M, and C Modes

6 Playback Mode

7 Wi-Fi Functions

8 Set-Up Menu

9 Accessories

10 Appendix

Index



Adjusting White Balance.....	65
Custom White Balance.....	65
Manually Correcting White Balance.....	66
Using Your Favorite Shades (Picture Style).....	67
Adjusting Picture Styles.....	68
Saving Customized Picture Styles.....	69
Shooting Range and Focusing.....	69
Selecting the AF Method.....	69
1-Point AF.....	69
AF+Tracking.....	70
Choosing Subjects to Focus On (Touch AF).....	71
Shooting with the AF Lock.....	71
Shooting with Servo AF.....	72
Changing the Focus Setting.....	73
Fine-tuning Focus.....	73
Shooting in Manual Focus Mode.....	74
Easily Identifying the Focus Area (MF Peaking).....	74
Flash.....	75
Changing the Flash Mode.....	75
Auto.....	75
On.....	75
Slow Synchro.....	75
Off.....	75
Adjusting the Flash Exposure Compensation.....	76
Shooting with the FE Lock.....	76
Changing the Flash Timing.....	77
Changing the Flash Metering Mode.....	77
Resetting Flash Settings.....	77
Other Settings.....	78
Changing the IS Mode Settings.....	78
Shooting Movies with Subjects at the Same Size Shown before Shooting.....	78

Lens Peripheral Illumination/ Chromatic Aberration Correction.....	79
Changing the Noise Reduction Level.....	80
Using Multi Shot Noise Reduction.....	80
Reducing Noise at Slow Shutter Speeds.....	81
5 Tv, Av, M, and C Modes.....	82
Specific Shutter Speeds ([Tv] Mode).....	82
Specific Aperture Values ([Av] Mode).....	83
Depth-of-Field Preview.....	83
Specific Shutter Speeds and Aperture Values ([M] Mode).....	84
Long (Bulb) Exposures.....	85
Adjusting the Flash Output.....	85
Specific Shutter Speeds and Aperture Values.....	86
Customizing Controls and Display.....	87
Customizing Display Information.....	87
Customizing Displayed Data.....	87
Setting Up Advanced Camera Functions.....	88
Adding Functions to Buttons and Dials.....	89
Saving Shooting Settings ([C] Mode).....	90
Settings that can be saved.....	90
Saving Commonly Used Shooting Menu Items (My Menu).....	91
6 Playback Mode.....	93
Viewing.....	93
Touch-Screen Operations.....	94
Switching Display Modes.....	95
Defining Displayed Shooting Data.....	95
Overexposure Warning (for Image Highlights).....	96
Brightness Histogram.....	96
RGB Histogram.....	96
Viewing Short Movies Created When Shooting Still Images (Digest Movies).....	96

Before Use

Basic Guide

Advanced Guide

1 Camera Basics

2 Auto Mode / Hybrid Auto Mode

3 Other Shooting Modes

4 P Mode

5 Tv, Av, M, and C Modes

6 Playback Mode

7 Wi-Fi Functions

8 Set-Up Menu

9 Accessories

10 Appendix

Index



Viewing by Date.....	97
Browsing and Filtering Images.....	97
Navigating through Images in an Index.....	97
Touch-Screen Operations.....	98
Finding Images Matching Specified Conditions.....	98
Using the Front Dial to Jump between Images.....	99
Touch-Screen Operations.....	100
Image Viewing Options.....	100
Magnifying Images.....	100
Touch-Screen Operations.....	101
Viewing Slideshows.....	101
Protecting Images.....	102
Using the Menu.....	102
Choosing Images Individually.....	103
Selecting a Range.....	103
Protecting All Images at Once.....	104
Clearing All Protection at Once.....	104
Erasing Images.....	105
Erasing Multiple Images at Once.....	105
Choosing a Selection Method.....	105
Choosing Images Individually.....	105
Selecting a Range.....	106
Specifying All Images at Once.....	106
Rotating Images.....	107
Using the Menu.....	107
Deactivating Auto Rotation.....	108
Applying Ratings.....	108
Using the Menu.....	108
Editing Still Images.....	109
Resizing Images.....	109
Using the Menu.....	110
Cropping.....	110

Applying Filter Effects.....	111
Correcting Red-Eye.....	112
Editing Movies.....	113
Reducing File Sizes.....	114
Editing Digest Movies.....	114
7 Wi-Fi Functions.....	115
Available Wi-Fi Features.....	115
Importing Images into a Smartphone.....	116
Sending Images to an NFC-Compatible Smartphone.....	116
Connecting via NFC When Camera Is Off	
or in Shooting Mode.....	116
Connecting via NFC When Camera Is in Playback Mode...	117
Adding a Smartphone Using the Wi-Fi Menu.....	118
Using Another Access Point.....	119
Confirming Access Point Compatibility.....	120
Using WPS-Compatible Access Points.....	120
Connecting to Listed Access Points.....	121
Previous Access Points.....	122
Sending Images to a Registered Web Service.....	122
Registering Web Services.....	122
Registering CANON iMAGE GATEWAY.....	123
Registering Other Web Services.....	124
Uploading Images to Web Services.....	125
Viewing Images Using a Media Player.....	126
Printing Images Wirelessly from a Connected Printer.....	127
Sending Images to Another Camera.....	129
Image Sending Options.....	130
Sending Multiple Images.....	130
Notes on Sending Images.....	130
Choosing the Number of Recording Pixels (Image Size).....	131
Adding Comments.....	131

Before Use

Basic Guide

Advanced Guide

1 Camera Basics

2 Auto Mode / Hybrid Auto Mode

3 Other Shooting Modes

4 P Mode

5 Tv, Av, M, and C Modes

6 Playback Mode

7 Wi-Fi Functions

8 Set-Up Menu

9 Accessories

10 Appendix

Index



Sending Images Automatically (Image Sync).....	131
Initial Preparations.....	131
Preparing the Camera	131
Preparing the Computer	132
Sending Images.....	132
Shooting Remotely.....	133
Editing or Erasing Wi-Fi Settings.....	134
Editing Connection Information	134
Changing a Device Nickname	134
Erasing Connection Information	135
Specifying Images to Share with Smartphones.....	135
Returning the Wi-Fi Settings to Default	136
8 Setting Menu.....	137
Adjusting Basic Camera Functions	137
Date-Based Image Storage	137
File Numbering	137
Formatting Memory Cards.....	138
Low-Level Formatting	138
Changing Video Formats.....	139
Electronic Level Calibration	139
Resetting the Electronic Level.....	139
Using Eco Mode	139
Power-Saving Adjustment	140
Screen Brightness	140
World Clock	141
Date and Time	141
Display Language.....	141
Silencing Camera Operations.....	142
Hiding Hints and Tips.....	142
Changing Touch Screen Settings	142
Cleaning the Image Sensor	142
Turning Auto Cleaning Off	142

Activating the Cleaner	143
Cleaning Manually	143
Checking Certification Logos.....	144
Setting Copyright Information to Record in Images.....	144
Deleting All Copyright Information	144
Adjusting Other Settings.....	145
Restoring Defaults	145
9 Accessories	146
System Map	147
Optional Accessories.....	148
Lens.....	148
Power Supplies.....	148
Flash.....	149
Other Accessories	149
Printers	150
Using Optional Accessories.....	150
Playback on a TV	150
Powering the Camera with Household Power	151
Remote Control Shooting	152
Using the Hot Shoe	152
Using Electronic Viewfinders (Sold Separately)	153
Using an External Flash (Sold Separately).....	154
Setting External Flash Functions.....	155
Setting External Flash Custom Functions	156
Resetting External Flash Functions.....	157
Using External Microphones.....	157
Using the Software.....	158
Software	158
Software Instruction Manual	158
Checking Your Computer Environment	158
Installing the Software	158
Saving Images to a Computer	159

Before Use

Basic Guide

Advanced Guide

1 Camera Basics

2 Auto Mode / Hybrid Auto Mode

3 Other Shooting Modes

4 P Mode

5 Tv, Av, M, and C Modes

6 Playback Mode

7 Wi-Fi Functions

8 Set-Up Menu

9 Accessories

10 Appendix

Index



Printing Images	160	Info Display 6.....	176
Easy Print	160	Summary of Movie Control Panel.....	176
Configuring Print Settings.....	161	Functions and Menu Tables	177
Cropping Images before Printing.....	162	Functions Available in Each Shooting Mode	177
Choosing Paper Size and Layout before Printing	162	Quick Settings	179
Available Layout Options.....	163	Shooting Tabs.....	181
Printing ID Photos	163	C.Fn Tab	186
Printing Movie Scenes.....	163	INFO. Quick Control	187
Movie Printing Options	163	Set Up Tab.....	187
Adding Images to the Print List (DPOF)	164	My Menu Tab	188
Configuring Print Settings.....	164	Playback Tab	188
Setting Up Printing for Individual Images	165	Playback Mode Quick Settings.....	188
Setting Up Printing for a Range of Images	165	Handling Precautions	189
Setting Up Printing for All Images.....	165	Specifications	190
Clearing All Images from the Print List	165	Type.....	190
Adding Images to a Photobook	166	Image Sensor	190
Choosing a Selection Method	166	Recording System	190
Adding Images Individually.....	166	Image Processing during Shooting	191
Adding All Images to a Photobook	166	Autofocus	191
Removing All Images from a Photobook	167	Exposure Control.....	191
10 Appendix	168	Shutter.....	192
Troubleshooting.....	168	Flash.....	192
On-screen Messages	172	Drive, Self-timer System.....	192
On-screen Information.....	174	Still Photo Shooting	192
During Shooting.....	174	Movie Shooting Settings.....	192
Battery Level	174	LCD Monitor	193
Playback.....	175	Playback.....	193
Info Display 1.....	175	Post-processing of Images.....	193
Info Display 2.....	175	Direct Printing	194
Info Display 3.....	175	Custom Functions	194
Info Display 4.....	175	Interface	194
Info Display 5.....	176	Wi-Fi	194

Before Use

Basic Guide

Advanced Guide

1 Camera Basics

2 Auto Mode / Hybrid Auto Mode

3 Other Shooting Modes

4 P Mode

5 Tv, Av, M, and C Modes

6 Playback Mode

7 Wi-Fi Functions

8 Set-Up Menu

9 Accessories

10 Appendix

Index



Network Functions.....	194
Power Supplies	195
Dimensions and Weight.....	195
Operation Environment	195
Number of Shots per Memory Card	195
Recording Time per Memory Card	196
Internal Flash Range Guide	196
Battery Pack LP-E17	196
Battery Charger LC-E17/LC-E17E	197
Index.....	198
Wi-Fi (Wireless LAN) Precautions.....	200
Radio Wave Interference Precautions	200
Security Precautions.....	200
Trademarks and Licensing	201
Disclaimer.....	201

Before Use

Basic Guide

Advanced Guide

1 Camera Basics

2 Auto Mode / Hybrid Auto Mode

3 Other Shooting Modes

4 P Mode

5 Tv, Av, M, and C Modes

6 Playback Mode

7 Wi-Fi Functions

8 Set-Up Menu

9 Accessories

10 Appendix

Index



Common Camera Operations

Shoot

- Use camera-determined settings (Auto Mode, Hybrid Auto Mode)
 - 📖35, 📖37
- Use the effects of your choice (Creative Assist)
 - 📖48
- Blur the background; keep the background in sharp focus (Av Mode)
 - 📖83
- Freeze movement; blur movement (Tv Mode)
 - 📖82
- Add effects to photos (Creative Filters)
 - 📖52
- Shoot continuously (Continuous Shooting)
 - 📖42
- Shoot in locations where flash is prohibited (Flash Off)
 - 📖36
- Include yourself in the shot (Self-Timer)
 - 📖40

View

- View images (Playback Mode)
 - 📖93
- Automatic playback (Slideshow)
 - 📖101
- On a TV
 - 📖150
- On a computer
 - 📖158
- Browse through images quickly
 - 📖97

- Erase images
 - 📖105

Shoot/View Movies

- Shoot movies
 - 📖35, 📖57
- View movies (Playback Mode)
 - 📖93

Print

- Print pictures
 - 📖160

Save

- Save images to a computer via a cable
 - 📖159

Use Wi-Fi Functions

- Send images to a smartphone
 - 📖116
- Share images online
 - 📖122
- Send images to a computer
 - 📖131

Before Use

Basic Guide

Advanced Guide

1 Camera Basics

2 Auto Mode / Hybrid Auto Mode

3 Other Shooting Modes

4 P Mode

5 Tv, Av, M, and C Modes

6 Playback Mode

7 Wi-Fi Functions

8 Set-Up Menu

9 Accessories

10 Appendix

Index



Safety Precautions

- Before using the product, ensure that you read the safety precautions described below. Always ensure that the product is used correctly.
- The safety precautions noted here are intended to prevent you and other persons from being injured or incurring property damage.
- Be sure to also check the guides included with any separately sold accessories you use.



Warning

Denotes the possibility of serious injury or death.

- Do not trigger the flash in close proximity to people's eyes. This may damage eyesight. In particular, remain at least 1 meter (3.3 feet) away from infants when using the flash.

- Store this equipment out of the reach of children and infants. A strap wound around a child's neck may result in asphyxiation. If your product uses a power cord, the cord becoming wound around a child's neck may result in asphyxiation.

The hot shoe cap is dangerous if swallowed. If swallowed, contact a doctor immediately.

- Use only recommended power sources.
- Do not disassemble, alter, or apply heat to the product.
- Do not peel off the label, if the battery pack has one.
- Avoid dropping or subjecting the product to severe impacts.
- Do not touch the interior of the product if it is broken, such as when dropped.
- Stop using the product immediately if it emits smoke or a strange smell, or otherwise behaves abnormally.
- Do not use organic solvents such as alcohol, benzene, or thinner to clean the product.
- Avoid contact with liquid, and do not allow liquid or foreign objects inside.

This could result in electrical shock or fire.

If the product gets wet, or if liquid or foreign objects get inside, remove the battery pack/batteries or unplug immediately.

- Do not look through the viewfinder or interchangeable lens (depending on which your product has) at intense light sources, such as the sun on a clear day or an intense artificial light source.

This could damage your eyesight.

- If your product uses an interchangeable lens, do not leave the lens or camera with the lens attached out in the sun without the lens cap on. This could result in fire.

- Do not touch the product during thunderstorms if it is plugged in. This could result in electrical shock or fire. Immediately stop using the product and distance yourself from it.

- Use only the recommended battery pack/batteries.

- Do not place the battery pack/batteries near or in direct flame. This may cause the battery pack/batteries to explode or leak, resulting in electrical shock, fire, or injuries. If leaking battery electrolyte comes into contact with eyes, mouth, skin, or clothing, immediately flush with water.

- If the product uses a battery charger, note the following precautions.
 - Remove the plug periodically and, using a dry cloth, wipe away any dust and dirt that has collected on the plug, the exterior of the power outlet, and the surrounding area.
 - Do not insert or remove the plug with wet hands.
 - Do not use the equipment in a manner that exceeds the rated capacity of the electrical outlet or wiring accessories. Do not use if the plug is damaged or not fully inserted in the outlet.
 - Do not allow dust or metal objects (such as pins or keys) to contact the terminals or plug.
 - Do not cut, damage, alter, or place heavy items on the power cord, if your product uses one.

This could result in electrical shock or fire.

Before Use

Basic Guide

Advanced Guide

1 Camera Basics

2 Auto Mode / Hybrid Auto Mode

3 Other Shooting Modes

4 P Mode

5 Tv, Av, M, and C Modes

6 Playback Mode

7 Wi-Fi Functions

8 Set-Up Menu

9 Accessories

10 Appendix

Index



- Turn the camera off in places where camera use is prohibited. The electromagnetic waves emitted by the camera may interfere with the operation of electronic instruments and other devices. Exercise adequate caution when using the product in places where use of electronic devices is restricted, such as inside airplanes and medical facilities.

- Do not allow the camera to maintain contact with skin for extended periods.

Even if the camera does not feel hot, this may cause low-temperature burns, manifested in redness of the skin or blistering. Use a tripod in hot places, or if you have poor circulation or insensitive skin.

 **Caution** Denotes the possibility of injury.

- When carrying the product by the strap, be careful not to bang it, subject it to strong impacts or shocks, or let it get caught on other objects.

- Be careful not to bump or push strongly on the lens. This could lead to injury or damage the camera.

- Be careful not to subject the screen to strong impacts. If the screen cracks, injury may result from the broken fragments.

- When using the flash, be careful not to cover it with your fingers or clothing. This could result in burns or damage to the flash.

- Avoid using, placing, or storing the product in the following places:
 - Places subject to direct sunlight
 - Places subject to temperatures above 40°C (104°F)
 - Humid or dusty places

These could cause leakage, overheating, or an explosion of the battery pack/batteries, resulting in electrical shock, fire, burns, or other injuries. Overheating and damage may result in electrical shock, fire, burns, or other injuries.

- The slideshow transition effects may cause discomfort when viewed for prolonged periods.

- When using optional lenses, lens filters, or filter adapters (if applicable), be sure to attach these accessories firmly. If the lens accessory becomes loose and falls off, it may crack, and the shards of glass may lead to cuts.

- On products that raise and lower the flash automatically, make sure to avoid pinching your fingers with the lowering flash. This could result in injury.

Caution Denotes the possibility of property damage.

- Do not aim the camera at intense light sources, such as the sun on a clear day or an intense artificial light source. Doing so may damage the image sensor or other internal components.

- When using the camera on a sandy beach or at a windy location, be careful not to allow dust or sand to enter the camera.

- On products that raise and lower the flash automatically, do not push the flash down or pry it open. This may cause the product to malfunction.

- Wipe off any dust, grime, or other foreign matter on the flash with a cotton swab or cloth. The heat emitted from the flash may cause foreign matter to smoke or the product to malfunction.

- Remove and store the battery pack/batteries when you are not using the product. Any battery leakage that occurs may cause product damage.

- Before you discard the battery pack/batteries, cover the terminals with tape or other insulators. Contacting other metal materials may lead to fire or explosions.

- Unplug any battery charger used with the product when not in use. Do not cover with a cloth or other objects when in use. Leaving the unit plugged in for a long period of time may cause it to overheat and distort, resulting in fire.

Before Use

Basic Guide

Advanced Guide

1 Camera Basics

2 Auto Mode / Hybrid Auto Mode

3 Other Shooting Modes

4 P Mode

5 Tv, Av, M, and C Modes

6 Playback Mode

7 Wi-Fi Functions

8 Set-Up Menu

9 Accessories

10 Appendix

Index



- Do not leave any dedicated battery packs near pets. Pets biting the battery pack could cause leakage, overheating, or explosion, resulting in product damage or fire.

- If your product uses multiple batteries, do not use batteries that have different levels of charge together, and do not use old and new batteries together. Do not insert the batteries with the + and – terminals reversed. This may cause the product to malfunction.

- Do not sit down with the camera in your pant pocket. Doing so may cause malfunctions or damage the screen.

- When putting the camera in your bag, ensure that hard objects do not come into contact with the screen. Also close the screen (so that it faces the body), if your product's screen closes.

- Do not attach any hard objects to the product. Doing so may cause malfunctions or damage the screen.



Before Use

Basic Guide

Advanced Guide

1 Camera Basics

2 Auto Mode / Hybrid Auto Mode

3 Other Shooting Modes

4 P Mode

5 Tv, Av, M, and C Modes

6 Playback Mode

7 Wi-Fi Functions

8 Set-Up Menu

9 Accessories

10 Appendix

Index



Basic Guide

Basic Operations

Basic information and instructions, from initial preparations to shooting and playback

Initial Preparations

Prepare for shooting as follows.

Attaching the Strap

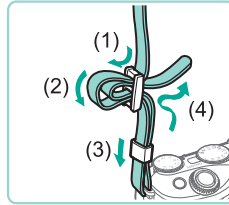

- Attach the included strap to the camera as shown.
- On the other side of the camera, attach the strap the same way.

Charging the Battery Pack

Before use, charge the battery pack with the included charger. Be sure to charge the battery pack initially, because the camera is not sold with the battery pack charged.

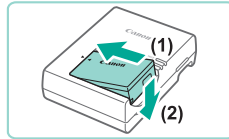

1 Insert the battery pack.

- Remove the cover from the battery pack, align the ▲ marks on the battery pack and charger, and insert the battery pack by pushing it in (1) and down (2).

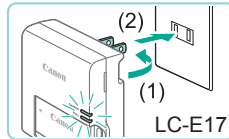

2 Charge the battery pack.

- **LC-E17:** Flip out the plug (1), and plug the charger into a power outlet (2).

Before Use

Basic Guide

Advanced Guide

1 Camera Basics

2 Auto Mode / Hybrid Auto Mode

3 Other Shooting Modes

4 P Mode

5 Tv, Av, M, and C Modes

6 Playback Mode

7 Wi-Fi Functions

8 Set-Up Menu

9 Accessories

10 Appendix

Index



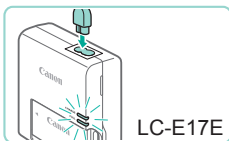

- **LC-E17E:** Plug the power cord into the charger and then plug the other end into a power outlet.
- The charging lamp turns orange, and charging begins.
- When charging is finished, the lamp turns green.

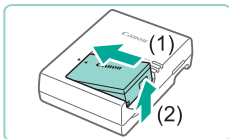

3 Remove the battery pack.

- After unplugging the battery charger, remove the battery pack by pushing it in (1) and up (2).



- Do not touch the battery charger plug for approximately 5 sec. after removing the charger from the outlet.
- To protect the battery pack and keep it in optimal condition, do not charge it continuously for more than 24 hours.
- For battery chargers that use a power cord, do not attach the charger or cord to other objects. Doing so could result in malfunction or damage to the product.
- If an abnormality occurs with the battery charger, the protective circuit stops charging, and the lamp blinks orange. In this instance, unplug the charger from the outlet, remove and then replace the battery pack, and wait a while before plugging it into the outlet again.



- For details on charging time, see “Battery Charger LC-E17/LC-E17E” (197). For details on the number of shots and recording time possible with a fully charged battery pack, see “Power Supplies” (195).
- Charged battery packs gradually lose their charge, even when they are not used. Charge the battery pack on (or immediately before) the day of use.
- As a visual reminder of the charge status, attach the battery cover with ▲ visible on a charged battery pack and ▲ concealed on an uncharged one.
- The charger can be used in regions with 100–240 V AC power (50/60 Hz). For power outlets in a different format, use a commercially available adapter for the plug. Never use an electrical transformer designed for traveling, which may damage the battery pack.

Inserting the Battery Pack and Memory Card

Insert the included battery pack and a memory card (sold separately). Note that before using a new memory card (or a memory card formatted in another device), you should format the memory card with this camera (138).

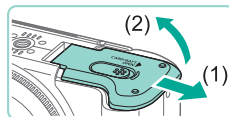

1 Open the cover.

- Slide the cover (1) and open it (2).

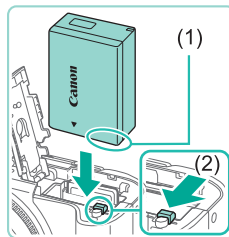

2 Insert the battery pack.

- Holding the battery pack with the terminals (1) facing as shown, move the battery lock down (2) and insert until the lock clicks shut.
- If you insert the battery pack facing the wrong way, it cannot be locked into the correct position. Always confirm that the battery pack is facing the right way and locks when inserted.

Before Use

Basic Guide

Advanced Guide

1 Camera Basics

2 Auto Mode / Hybrid Auto Mode

3 Other Shooting Modes

4 P Mode

5 Tv, Av, M, and C Modes

6 Playback Mode

7 Wi-Fi Functions

8 Set-Up Menu

9 Accessories

10 Appendix

Index



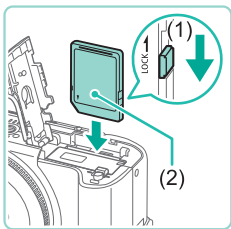

3 Check the card's write-protect tab and insert the memory card.

- Recording is not possible on memory cards with a write-protect tab when the tab is in the locked position. Slide the tab to the unlocked position (1).
- Insert the memory card with the label (2) facing as shown until it clicks into place.
- Make sure the memory card is facing the right way when you insert it. Inserting memory cards facing the wrong way may damage the camera.

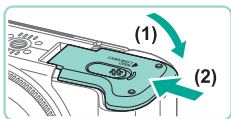

4 Close the cover.

- Lower the cover (1) and hold it down as you slide it, until it clicks into the closed position (2).



- Look at the screen display for the number of shots and movie length that can be shot with the current card (123).

Removing the Battery Pack and Memory Card

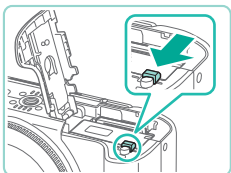

Remove the battery pack.

- Open the cover and press the battery lock in the direction of the arrow.
- The battery pack will pop up.

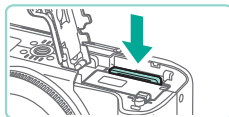

Remove the memory card.

- Push the memory card in until it clicks, and then slowly release it.
- The memory card will pop up.

Setting the Date and Time

Set the current date and time correctly as follows if the [Date/Time] screen is displayed when you turn the camera on. Information you specify this way is recorded in image properties when you shoot, and it is used when you manage images by shooting date or print images showing the date.

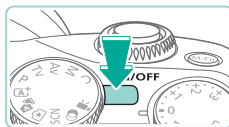

1 Turn the camera on.

- Press the power button.
- The [Date/Time] screen is displayed.

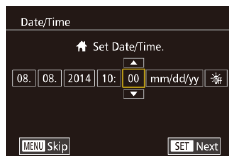

2 Set the date and time.

- Press the [◀][▶] buttons to choose an option.
- Press the [▲][▼] buttons or turn the [DISP] dial to specify the date.
- When finished, press the [OK] button.

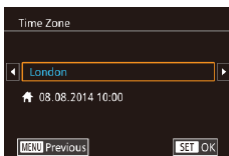

3 Specify your home time zone.

- Press the [◀][▶] buttons to choose your home time zone.

Before Use

Basic Guide

Advanced Guide

1 Camera Basics

2 Auto Mode / Hybrid Auto Mode

3 Other Shooting Modes

4 P Mode

5 Tv, Av, M, and C Modes

6 Playback Mode

7 Wi-Fi Functions

8 Set-Up Menu

9 Accessories

10 Appendix

Index



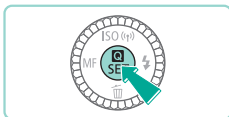

4 Finish the setup process.

- Press the **[SET]** button when finished. After a confirmation message, the setting screen is no longer displayed.
- To turn off the camera, press the power button.



- Unless you set the date, time, and home time zone, the [Date/Time] screen will be displayed each time you turn the camera on. Specify the correct information.



- To set daylight saving time (1 hour ahead), choose **[Off]** in step 2 and then choose **[On]** by pressing the **[▲]**/**[▼]** buttons or turning the **[DISP]** dial.



- You can also set the date and time by touching the desired option on the screen shown in step 2 and then touching **[▲]**/**[▼]** to adjust values, followed by **[SET]**. Similarly, to select your time zone in the screen shown in step 3, touch **[◀]**/**[▶]** to choose your time zone and then touch **[SET]** to confirm.

Changing the Date and Time

Adjust the date and time as follows.

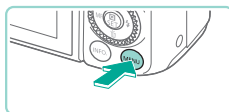

1 Access the menu screen.

- Press the **[MENU]** button.

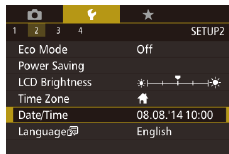

2 Choose [Date/Time].

- Press the **[◀]**/**[▶]** buttons or use the **[DISP]** dial to select the **[2]** tab.
- Press the **[▲]**/**[▼]** buttons or turn the **[DISP]** dial to choose [Date/Time], and then press the **[SET]** button.

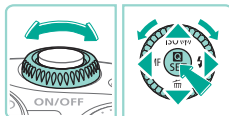

3 Change the date/time.

- Follow step 2 in “Setting the Date and Time” (18) to adjust the settings.
- Press the **[MENU]** button to close the menu screen.



- The camera includes a built-in date/time battery (backup battery). Date/time settings are retained for about 3 weeks after the battery pack is removed.
- The date/time battery will be charged in about 4 hours once you insert a charged battery pack or connect the camera to an AC adapter kit (sold separately, 148), even if the camera is left off.
- Once the date/time battery is depleted, the [Date/Time] screen will be displayed when you turn the camera on. Set the correct date and time as described in “Setting the Date and Time” (18).

Before Use

Basic Guide

Advanced Guide

1 Camera Basics

2 Auto Mode / Hybrid Auto Mode

3 Other Shooting Modes

4 P Mode

5 Tv, Av, M, and C Modes

6 Playback Mode

7 Wi-Fi Functions

8 Set-Up Menu

9 Accessories

10 Appendix

Index



Display Language

Change the display language as needed.



1 Enter Playback mode.

- Press the [▶] button.

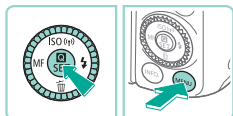

2 Access the setting screen.

- Press and hold the [MENU] button, and then press the [MENU] button.

English	Norsk	Română
Deutsch	Svenska	Türkçe
Français	Español	العربية
Nederlands	Ελληνικά	മലയാളം
Dansk	Русский	简体中文
Português	Polski	繁體中文
Suomi	Čeština	한국어
Italiano	Magyar	日本語
Українська		SET OK

3 Set the display language.

- Press the [▲][▼][◀][▶] buttons or turn the [DISP.] dial to choose a language, and then press the [MENU] button.
- Once the display language has been set, the setting screen is no longer displayed.



- You can also change the display language by pressing the [MENU] button and choosing [Language] on the [2] tab.



- You can also set the display language by touching a language on the screen in step 3 and then touching it again.

Attaching a Lens

The camera is compatible with EF-M lenses. Use the Mount Adapter EF-EOS M to attach EF and EF-S lenses as well (21).

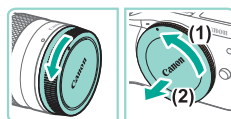

1 Make sure the camera is off.

2 Remove the caps.

- Remove the rear lens cap and the body cap by turning them as shown by the arrows.

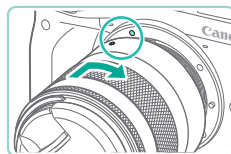

3 Attach the lens.

- Align the mount indexes (the white circles) on the lens and camera, and turn the lens until it clicks into place, as shown by the arrow.

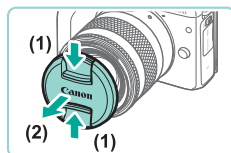

4 Remove the front lens cap.

- Turn the zoom ring on the lens to zoom.
- Zoom before focusing, because the image may become unfocused if you focus before zooming.

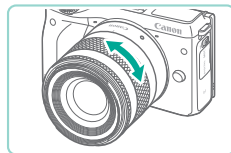

Before Use

Basic Guide

Advanced Guide

1 Camera Basics

2 Auto Mode / Hybrid Auto Mode

3 Other Shooting Modes

4 P Mode

5 Tv, Av, M, and C Modes

6 Playback Mode

7 Wi-Fi Functions

8 Set-Up Menu

9 Accessories

10 Appendix

Index





- To protect the lens, keep the lens cap on when the camera is not in use.

Detaching a Lens

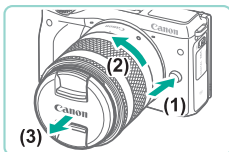

- Make sure the camera is off.
- While pressing the lens release button (1), turn the lens as shown by the arrow (2).
- Turn the lens until it stops and then detach it (3).
- Attach the lens cap to the detached lens.



- **Minimizing Dust**
 - When changing lenses, do it quickly in a place with minimal dust.
 - When storing the camera without a lens attached, be sure to attach the body cap to the camera.
 - Remove dust on the body cap before attaching it.



- The image sensor is smaller than the 35mm format, which causes the attached lens's focal length to appear magnified about 1.6x. For example, an 18–55 mm focal length would be equivalent to an approx. 29–88 mm focal length on a 35mm camera.

Lens Instruction Manual

Download electronic manuals for your lens from the following Internet address.

<http://www.canon.com/icpd/>

Attaching EF and EF-S Lenses

If you use Mount Adapter EF-EOS M, you can use EF and EF-S lenses.

1 Make sure the camera is off.

2 Remove the caps.

- Remove the caps, following step 2 in “Attaching a Lens” (p.20).

3 Attach the lens to the adapter.

- To mount an EF lens, align the mount indexes (the red circles) on the lens and adapter, and turn the lens until it clicks into place, as shown by the arrow.
- To mount an EF-S lens, align the mount indexes (the white squares) on the lens and adapter, and turn the lens until it clicks into place, as shown by the arrow.

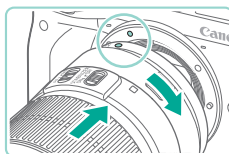
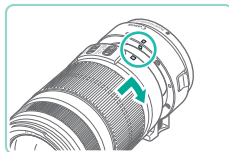

4 Attach the adapter to the camera.

- Align the mount indexes (the white circles) on the adapter and camera. Turn the lens as shown by the arrow until it clicks into place.

Before Use

Basic Guide

Advanced Guide

1 Camera Basics

2 Auto Mode / Hybrid Auto Mode

3 Other Shooting Modes

4 P Mode

5 Tv, Av, M, and C Modes

6 Playback Mode

7 Wi-Fi Functions

8 Set-Up Menu

9 Accessories

10 Appendix

Index





- If using a lens that is heavier than the camera, make sure support is provided for the lens while carrying and shooting.
- Using adapters may extend the minimum shooting distance of the lens or change its maximum magnification ratio or shooting range.
- If the front part (focusing ring) of the lens rotates during autofocus, do not touch the rotating part.
- The focus preset function on some super telephoto lenses is unavailable. Also, the power zoom function of lens EF35–80mm f/4–5.6 PZ is unavailable.

Detaching a Lens

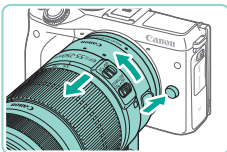

1 Detach the adapter.

- Make sure the camera is off.
- While pressing the lens release button, turn the adapter (with lens attached) as shown by the arrow.
- Turn the adapter until it stops and then detach it.

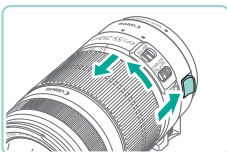

2 Detach the lens.

- While pushing down on the detach lever on the adapter, turn the lens counterclockwise.
- Turn the lens until it stops and then detach it.
- Attach the lens cap to the detached lens.

Using a Tripod

Use the tripod foot included with the adapter to attach the camera to a tripod. Do not use the camera's tripod socket.

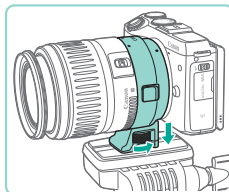

- Attach the tripod foot to the adapter. Use the turning dial to secure it firmly in place.
- Attach the tripod to the socket of the tripod foot.



- If using an EF lens with a tripod foot (such as super telephoto lenses), attach the tripod foot socket directly to the tripod.

Stabilizing the Image

If using a lens with an image stabilization function, you can compensate for small camera movements (shaking) that occur while shooting. Lenses with built-in image stabilization have “IS” in their names.

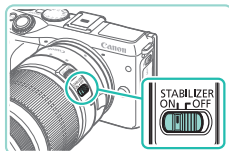

- Move the lens's image stabilizer switch to the [ON] position.

Before Use

Basic Guide

Advanced Guide

1 Camera Basics

2 Auto Mode / Hybrid Auto Mode

3 Other Shooting Modes

4 P Mode

5 Tv, Av, M, and C Modes

6 Playback Mode

7 Wi-Fi Functions

8 Set-Up Menu

9 Accessories

10 Appendix

Index



Trying the Camera Out

▶ Still Images ▶ Movies

Follow these instructions to turn the camera on, shoot still images or movies, and then view them.

Holding the Camera

To obtain sharp images, hold the camera still to minimize camera shake.

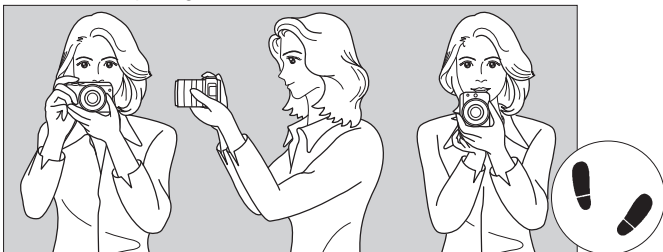

Horizontal shooting

Vertical shooting

- (1) Wrap your right hand around the camera grip firmly.
- (2) Hold the lens bottom with your left hand.
- (3) Rest your hand's right index finger lightly on the shutter button.
- (4) Press your arms and elbows lightly against the front of your body.
- (5) To maintain a stable stance, place one foot slightly ahead of the other.

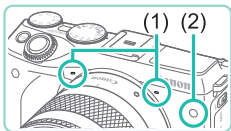

- When shooting movies, be careful not to cover the microphones (1).
- When you press the shutter button halfway in dark locations, the front lamp (2) may light up to improve focus. Make sure this light is not blocked by anything.

Shooting in Scene Intelligent Auto Mode

For fully automatic selection of the optimal settings for specific scenes, simply let the camera determine the subject and shooting conditions.

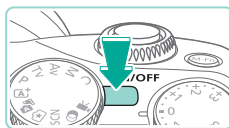

1 Turn the camera on.

- Press the power button.



2 Enter [A+] mode.

- Set the mode dial to [A+].
- A scene icon (1) is displayed in the upper left of the screen.
- The top of the screen shows the number of shots (2) and length of movie (3) you can shoot with the current card.
- Frames displayed around any detected faces or other subjects indicate that they are in focus.



3 Compose the shot.

- If your lens supports zooming, turn the zoom ring on the lens with your fingers to zoom.

Before Use

Basic Guide

Advanced Guide

1 Camera Basics

2 Auto Mode / Hybrid Auto Mode

3 Other Shooting Modes

4 P Mode

5 Tv, Av, M, and C Modes

6 Playback Mode

7 Wi-Fi Functions

8 Set-Up Menu

9 Accessories

10 Appendix

Index



4 Shoot.

Shooting Still Images

1) Focus.

- Press the shutter button lightly, halfway down. The camera beeps twice after focusing, and AF frames are displayed to indicate image areas in focus.

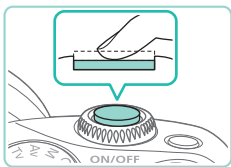

- If [⚡] flashes on-screen, move the [⚡] switch to raise the flash. The flash will fire upon shooting. If you prefer not to use the flash, push it down with your finger, into the camera.

2) Shoot.

- Press the shutter button all the way down to shoot. In low-light conditions, the flash fires automatically when you have it raised.
- The captured image will be displayed for approximately 2 seconds on the screen.
- Even while the shot is displayed, you can take another shot by pressing the shutter button again.

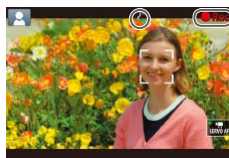
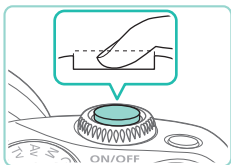

Recording Movies

1) Start recording.

- Press the Movie button to begin recording. [● Rec] is displayed with the elapsed time.
- Displays black bars on the top and bottom edges of the screen. The black bars indicate image areas not recorded.
- Frames displayed around any detected faces indicate that they are in focus.
- Once recording begins, take your finger off the movie button.

2) Finish recording.

- To stop movie recording, press the movie button again.



- An orange AF frame is displayed with [!] if the camera cannot focus when you press the shutter button halfway. No picture is taken, even if you press the shutter button all the way down.
- If using a lens that supports Dynamic IS (78), the camera adjusts the range displayed on-screen to make the subject larger once you begin shooting a movie.



Viewing

After shooting still images and movies, you can view them on the screen as follows.



1 Enter Playback mode.

- Press the [▶] button.
- Your last shot is displayed.



2 Choose images.

- To view the previous image, press the [◀] button or turn the [Q] dial counterclockwise. To view the next image, press the [▶] button or turn the [Q] dial clockwise.
- Press and hold the [◀]([▶]) buttons to browse through images quickly.
- To access Scroll Display mode, turn the [Q] dial rapidly. In this mode, turn the [Q] dial to browse through images.
- To return to single-image display, press the [Q] button.

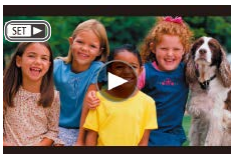
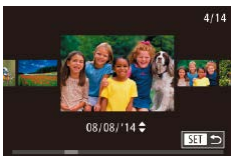

- Movies are identified by a [SET ▶] icon. To play movies, go to step 3.



3 Play movies.

- Press the [Q] button, press the [▲]([▼]) buttons to choose [▶], and then press the [Q] button again.
- Playback now begins, and after the movie is finished, [SET ▶] is displayed.
- To adjust the volume during playback, press the [▲]([▼]) buttons.



- To switch to shooting mode from playback mode, press the shutter button down halfway (28), press the [▶] button, or turn the mode dial.



- You can also start movie playback by touching [▶]. To adjust the volume, drag quickly up or down across the screen during playback.

Before Use

Basic Guide

Advanced Guide

1 Camera Basics

2 Auto Mode / Hybrid Auto Mode

3 Other Shooting Modes

4 P Mode

5 Tv, Av, M, and C Modes

6 Playback Mode

7 Wi-Fi Functions

8 Set-Up Menu

9 Accessories

10 Appendix

Index



Erasing Images

You can choose and erase unneeded images one by one. Be careful when erasing images, because they cannot be recovered.

1 Choose an image to erase.

- Press the [◀][▶] buttons or turn the [DISP.] dial to choose an image.



2 Erase the images.

- Press the [▼] button.
- After [Erase?] is displayed, press the [◀][▶] buttons or turn the [DISP.] dial to choose [Erase], and then press the [OK] button.
- The current image is now erased.
- To cancel erasure, press the [◀][▶] buttons or turn the [DISP.] dial to choose [Cancel], and then press the [OK] button.



- You can choose multiple images to erase at once (105).



- You can also erase the current image by touching [Erase] on the screen in step 2.

Before Use

Basic Guide

Advanced Guide

1 Camera Basics

2 Auto Mode / Hybrid Auto Mode

3 Other Shooting Modes

4 P Mode

5 Tv, Av, M, and C Modes

6 Playback Mode

7 Wi-Fi Functions

8 Set-Up Menu

9 Accessories

10 Appendix

Index



Advanced Guide

1

Camera Basics

Other basic operations and more ways to enjoy your camera, including shooting and playback options

On/Off

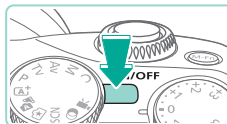

Shooting Mode

- Press the power button to turn the camera on and prepare for shooting.
- To turn the camera off, press the power button again.



Playback Mode

- Press the [▶] button to turn the camera on and view your shots.
- Press the [▶] button again to go to shooting mode.
- To turn off the camera, press the power button.



- When an EF-M lens is attached to the camera and the power is off, the aperture stops down to reduce the amount of light entering the camera and protect the internal components of the camera. As a result, when you turn the camera on or off, the aperture makes a small noise as it opens or closes.
- When you turn the camera on or off, sensor cleaning will be executed automatically. (A small sound may be heard.) After turning on the camera, the LCD monitor will display the [] icon while the sensor is being cleaned. The [] icon may not be displayed if you turn the camera on and off rapidly over a short period of time.
- To switch to shooting mode from playback mode, press the shutter button down halfway (p.28), press the [▶] button, or turn the mode dial.

Before Use

Basic Guide

Advanced Guide

1 Camera Basics

2 Auto Mode / Hybrid Auto Mode

3 Other Shooting Modes

4 P Mode

5 Tv, Av, M, and C Modes

6 Playback Mode

7 Wi-Fi Functions

8 Set-Up Menu

9 Accessories

10 Appendix

Index



Power-Saving Features (Auto Power Down)

As a way to conserve battery power, the camera automatically deactivates the screen (Display Off) and then turns itself off after a specific period of inactivity.

Power Saving in Shooting Mode

The screen is automatically deactivated after about one minute of inactivity. In about two more minutes, the camera turns itself off. To activate the screen and prepare for shooting when the screen is off but the (rear) indicator lamp is still on, press the shutter button halfway (📖28).

Power Saving in Playback Mode

The camera turns itself off automatically after about five minutes of inactivity.



- You can deactivate Auto Power Down and adjust the timing of Display Off, if you prefer (📖140).
- Power saving is not active while the camera is connected to other devices via Wi-Fi (📖115) or connected to a computer (📖159).

Shutter Button

To ensure that you focus on the intended subject when shooting, first lightly press the shutter button halfway down to focus, and then press the button all the way down to shoot.

In this manual, shutter button operations are described as pressing the button *halfway* or *all the way down*.

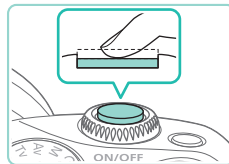

1 Press halfway. (Press lightly to focus.)

- Press the shutter button halfway. The camera beeps twice, and frames are displayed around image areas in focus.

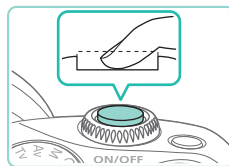

2 Press all the way down. (From the halfway position, press fully to shoot.)

- The shot is taken.



- Your intended subject may be out of focus if you shoot without initially pressing the shutter button halfway.

Before Use

Basic Guide

Advanced Guide

1 Camera Basics

2 Auto Mode / Hybrid Auto Mode

3 Other Shooting Modes

4 P Mode

5 Tv, Av, M, and C Modes

6 Playback Mode

7 Wi-Fi Functions

8 Set-Up Menu

9 Accessories

10 Appendix

Index



Shooting Modes

Use the mode dial to access each shooting mode.

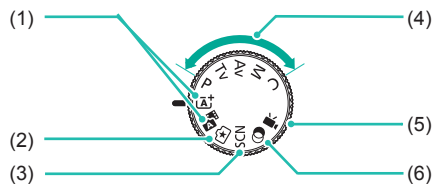

- (1) **Scene Intelligent Auto Mode/ Hybrid Auto Mode**
Fully automatic shooting, with camera-determined settings (📖35, 📖37).
- (2) **Creative Assist Mode**
Get the results and effects you want quickly and easily. Settings can also be saved and loaded (📖48).
- (3) **Special Scene Mode**
Shoot with optimal settings for specific scenes (📖51).
- (4) **P, Tv, Av, M, C Modes**
Take a variety of shots using your preferred settings (📖60, 📖82, 📖83, 📖84, 📖90).
- (5) **Movie Mode**
For shooting movies (📖57, 📖86). You can also shoot movies when the mode dial is not set to Movie mode, simply by pressing the movie button.
- (6) **Creative Filters Mode**
Add a variety of effects to images when shooting (📖52).



- You can turn the mode dial to switch to shooting mode from playback mode.

Adjusting the Angle of the LCD Monitor

You can adjust the screen angle and orientation to suit the scene or how you are shooting.

Tilting the Screen Downward

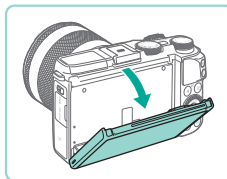

- Pull the top of the screen down toward you.
- The screen can be tilted downward approximately 45°.

Tilting the Screen Upward

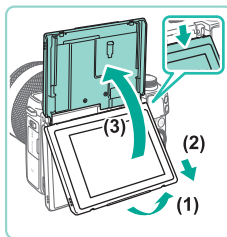

- Pull the bottom of the screen forward until it clicks (1), slide the screen down (2), and then rotate it upward (3).
- The screen can be tilted upward approximately 180°.
- When you want to shoot from the front of the camera, rotate the LCD monitor upward to view the screen from the lens side. The mirror image of the scene is displayed (the image is rotated 180° on the vertical axis).
- When finished, rotate the screen downward (1) and then slide it up while pushing in until it clicks (2).

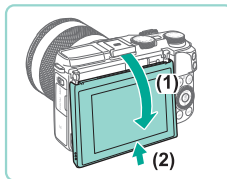

Before Use

Basic Guide

Advanced Guide

1 Camera Basics

2 Auto Mode / Hybrid Auto Mode

3 Other Shooting Modes

4 P Mode

5 Tv, Av, M, and C Modes

6 Playback Mode

7 Wi-Fi Functions

8 Set-Up Menu

9 Accessories

10 Appendix

Index





- Keep the screen closed when the camera is not in use.
- Do not try to open the screen beyond the angles described, as this may damage it.



- Go to the Menu (32) and set [Reverse Disp.] to [Off] on the [1] tab to turn off the mirror-image function.

Shooting Display Options

Press the [INFO] button to switch between displaying shooting information, the grid lines and level.

This can be defined in more detail on the [1] tab, under [Shooting information display] (87).



- Screen brightness is automatically increased by the night view function when you are shooting under low light, making it easier to check how shots are composed. However, on-screen image brightness may not match the brightness of your shots. Note that any on-screen image distortion or jerky subject motion will not affect recorded images.
- For playback display options, see “Switching Display Modes” (95).

Before Use

Basic Guide

Advanced Guide

1 Camera Basics

2 Auto Mode / Hybrid Auto Mode

3 Other Shooting Modes

4 P Mode

5 Tv, Av, M, and C Modes

6 Playback Mode

7 Wi-Fi Functions

8 Set-Up Menu

9 Accessories

10 Appendix

Index



Using the Quick Setting Menu

Commonly used functions can be configured in the **Q** (Quick Setting) menu.

Note that menu items and options vary depending on the shooting mode (📖 179) or playback mode (📖 188).

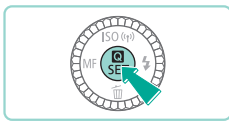

1 Access the **Q** menu.

- Press the **[Q]** button.



2 Choose a menu item.

- Press the **[▲]**/**[▼]** buttons to choose a menu item (1).
- Available options (2) are shown at the bottom of the screen.

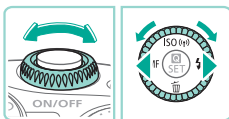

3 Choose an option.

- Press the **[◀]**/**[▶]** buttons or turn the **[ISO]**/**[MF]** dials to select an option.
- Options labeled with a **[INFO]** icon can be configured by pressing the **[INFO]** button.

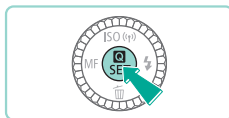

4 Finish the setup process.

- Press the **[Q]** button.
- The screen before you pressed the **[Q]** button in step 1 is displayed again, showing the option you configured.



- To undo any accidental setting changes, you can restore the camera's default settings (📖 145).
- Select **[R]** in the menu and press the **[Q]** button to close the options.

Using Touch-Screen Operations to Configure Settings



- Touch the **[Q]** button on the upper right of the screen to open the Quick Setting menu.
- Touch the on-screen menu options to make selections.
- Touch **[↶]** within a menu option, or touch the currently selected option, to go back to the previous screen.
- You can access the screen for options labeled with a **[INFO]** icon by touching **[INFO]**.

Before Use

Basic Guide

Advanced Guide

1 Camera Basics

2 Auto Mode / Hybrid Auto Mode

3 Other Shooting Modes

4 P Mode

5 Tv, Av, M, and C Modes

6 Playback Mode

7 Wi-Fi Functions

8 Set-Up Menu

9 Accessories

10 Appendix

Index



Using the Menu Screen

Configure a variety of camera functions through the menu screen as follows.

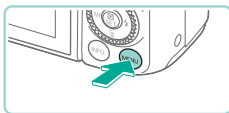

1 Access the menu screen.

- Press the [MENU] button.

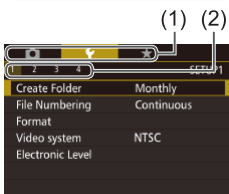

2 Choose a tab.

- Use the [◀][▶] buttons or turn the [☀] dial to select a tab.
- There are two kinds of tabs: System tabs (1) related to shooting [📷], playback [▶], settings [⚙] and more, and the individual page tabs (2) under each system tab. This guide refers to both tab types together in the text (example: the "[📷1]" tab").

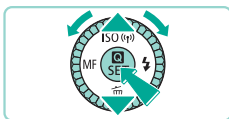
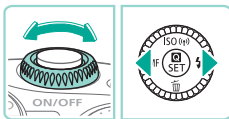

3 Choose a menu item.

- Press the [▲][▼] buttons or turn the [🌀] dial to choose a menu item, and then press the [📷] button.
- For menu items with options not shown, first press the [📷] button to switch screens, and then either press the [▲][▼] buttons or turn the [🌀] dial to select the menu item.
- To return to the previous screen, press the [MENU] button.

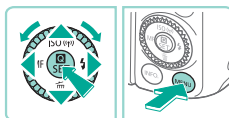
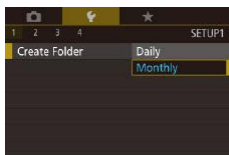

4 Choose an option.

- For options with a vertical menu of selections available, press the [▲][▼] buttons or turn the [🌀] dial to choose a selection.
- For options with a horizontal menu, press the [◀][▶] buttons or turn the [🌀] dial to choose an option.

5 Finish the setup process.

- When finished, press the [📷] button to return to option selection.
- Press the [MENU] button to return to the screen displayed before you pressed the [MENU] button in step 1.



- To undo any accidental setting changes, you can restore the camera's default settings (📖145).
- Available menu items vary depending on the selected shooting or playback mode (📖181 – 📖188).

Before Use

Basic Guide

Advanced Guide

1 Camera Basics

2 Auto Mode / Hybrid Auto Mode

3 Other Shooting Modes

4 P Mode

5 Tv, Av, M, and C Modes

6 Playback Mode

7 Wi-Fi Functions

8 Set-Up Menu

9 Accessories

10 Appendix

Index



Touch-Screen Operations

- To access tabs, press the [MENU] button to access the menu, touch a system tab, and then a page tab to select a menu tab.
- Touch the desired setting to select it and then touch it again.
- When finished, touch the option to return to the menu screen.
- To configure menu items for which options are not shown, first touch the menu item to access the setting screen. To return to the previous screen, touch [MENU ↩].
- You can also touch input elements (such as check boxes or text fields) to select them, and you can enter text by touching the on-screen keyboard.
- The [INFO] and [MENU] on-screen buttons have the same functions as the [INFO] and [MENU] buttons.
- To dismiss the menu, press the [MENU] button again.

On-Screen Keyboard

Use the on-screen keyboard to enter information for Wi-Fi connections (115). Note that the length and type of information you can enter varies depending on the function you are using.



Entering Characters

- Touch the characters to enter them.
- The amount of information you can enter (1) varies depending on the function you are using.

Moving the Cursor

- Touch [←][→].

Entering Line Breaks

- Touch [↵].

Switching Input Modes

- Touch [123] to switch between numbers and symbols.
- Touch [⇧] to enter capital letters.
- Available input modes vary depending on the function you are using.

Deleting Characters

- Touch [⌫] to delete the previous character.

Confirming Input and Returning to the Previous Screen

- Touch [MENU ↩].

Before Use

Basic Guide

Advanced Guide

1 Camera Basics

2 Auto Mode / Hybrid Auto Mode

3 Other Shooting Modes

4 P Mode

5 Tv, Av, M, and C Modes

6 Playback Mode

7 Wi-Fi Functions

8 Set-Up Menu

9 Accessories

10 Appendix

Index





- Press the [▲][▼][◀][▶] buttons or turn the [●] dial to select characters and icons. Press the [OK] button to make entries. Turn the [◂] dial to move the cursor directly between characters. Press the [MENU] button to go back to the previous screen.

Indicator Display

The indicator on the back of the camera (📖3) lights up or blinks depending on the camera status.

Color	Indicator Status	Camera Status
Green	On	Connected to a computer (📖159), or display off (📖28, 📖139, 📖140)
	Blinking	Starting up, recording/reading/transmitting images, shooting long exposures (📖82, 📖84), or connecting/transmitting via Wi-Fi



- When the indicator blinks green, never turn the camera off, open the memory card/battery cover, or shake or jolt the camera, which may corrupt images or damage the camera or memory card.

Before Use

Basic Guide

Advanced Guide

1 Camera Basics

2 Auto Mode / Hybrid Auto Mode

3 Other Shooting Modes

4 P Mode

5 Tv, Av, M, and C Modes

6 Playback Mode

7 Wi-Fi Functions

8 Set-Up Menu

9 Accessories

10 Appendix

Index



2

Auto Mode / Hybrid Auto Mode

Convenient mode for easy shots with greater control over shooting

Shooting with Camera-Determined Settings

For fully automatic selection of the optimal settings for specific scenes, simply let the camera determine the subject and shooting conditions.

Shooting (Scene Intelligent Auto)

▶ Still Images ▶ Movies

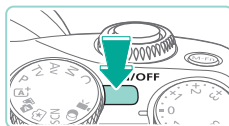

1 Turn the camera on.

- Press the power button.



2 Enter [A+] mode.

- Set the mode dial to [A+].
- A scene icon is displayed in the upper left of the screen (📖 39).
- Frames are displayed around faces and subjects that have been detected, indicating that they are in focus.



3 Compose the shot.

- If your lens supports zooming, turn the zoom ring on the lens with your fingers to zoom.



Before Use

Basic Guide

Advanced Guide

1 Camera Basics

2 Auto Mode / Hybrid Auto Mode

3 Other Shooting Modes

4 P Mode

5 Tv, Av, M, and C Modes

6 Playback Mode

7 Wi-Fi Functions

8 Set-Up Menu

9 Accessories

10 Appendix

Index



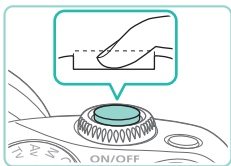
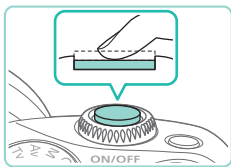

4 Shoot.

Shooting Still Images



1) Focus.

- Press the shutter button halfway. The camera beeps twice after focusing, and AF frames are displayed to indicate image areas in focus.

- If  flashes on-screen, move the  switch to raise the flash. It will fire when shooting. If you prefer not to use the flash, push it down with your finger, into the camera.

2) Shoot.

- Press the shutter button all the way down to shoot. In low-light conditions, the flash fires automatically when you have it raised.
- The captured image will be displayed for approximately 2 seconds on the screen.
- Even while the shot is displayed, you can take another shot by pressing the shutter button again.

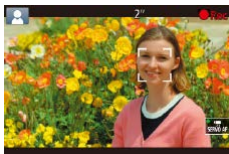

Recording Movies

1) Start recording.

- Press the movie button. Recording begins, and  is displayed with the elapsed time.
- Black bars displayed on the top and bottom edges of the screen indicate image areas not recorded.
- Frames displayed around any detected faces indicate that they are in focus.
- Once recording begins, take your finger off the movie button.

2) Resize the subject and recompose the shot as needed.

- To resize the subject, repeat the operations in step 3. However, note that the sound of camera operations will be recorded.
- When you recompose shots, the focus, brightness, and colors will be automatically adjusted.

3) Finish recording.

- To stop movie recording, press the movie button again.
- Recording will stop automatically when the memory card becomes full.

Before Use

Basic Guide

Advanced Guide

1 Camera Basics

2 Auto Mode / Hybrid Auto Mode

3 Other Shooting Modes

4 P Mode

5 Tv, Av, M, and C Modes

6 Playback Mode

7 Wi-Fi Functions

8 Set-Up Menu

9 Accessories

10 Appendix

Index



Shooting in Hybrid Auto Mode

► Still Images ► Movies

You can make a short movie of the day just by shooting still images. The camera records 2 – 4-second clips of scenes before each shot, which are later combined in a digest movie.



1 Enter [A+] mode.

- Follow step 2 in “Shooting (Scene Intelligent Auto)” (📖35), and choose [A+].

2 Compose the shot.

- Follow steps 3 – 4 in “Shooting (Scene Intelligent Auto)” (📖35) to compose the shot and focus.
- For more impressive digest movies, aim the camera at subjects about four seconds before shooting still images.



3 Shoot.

- Follow step 4 in “Shooting (Scene Intelligent Auto)” (📖36) to shoot a still image.
- The camera records both a still image and movie clip. The clip, which ends with the still image and a shutter sound, forms a single chapter in the digest movie.



- Battery life is shorter in this mode than in [A+] mode, because digest movies are recorded for each shot.
- A digest movie may not be recorded if you shoot a still image immediately after turning the camera on, choosing [A+] mode, or operating the camera in other ways.
- Sounds and vibrations from operating the camera or lens will be recorded in digest movies.



- The quality of digest movies is [HD 29.97P] (in NTSC) or [HD 25.00P] (in PAL). This is dependent on your video format settings (📖139).
- Sounds are not played when you press the shutter button halfway or trigger the self-timer.
- Digest movies are saved as separate movie files in the following cases even if they were recorded on the same day in [A+] mode.
 - The digest movie file size reaches approximately 4 GB, or the total recording time reaches approximately 13 minutes and 20 seconds.
 - The digest movie is protected (📖102).
 - Daylight saving time (📖18), video system (📖139), time zone settings (📖141) or copyright information (📖144) are changed.
 - A new folder is created (📖137).
- Recorded shutter sounds cannot be modified or erased.
- If you prefer to record digest movies without still images, adjust the setting in advance. Choose MENU (📖32) > [4] tab > [Digest Type] > [No Stills] (📖32).
- Individual chapters can be edited (📖114).

Digest Movie Playback

Display a still image shot in [A+] mode to play the digest movie created on the same day, or specify the date of the digest movie to play (📖96).

Still Images/Movies



- If the camera is turned on while the [MENU] button is held down, the camera will no longer sound. To activate sounds again, press the [MENU] button and choose [Beep] on the [3] tab, and then press the [▲][▼] buttons to choose [On].

Before Use

Basic Guide

Advanced Guide

1 Camera Basics

2 Auto Mode / Hybrid Auto Mode

3 Other Shooting Modes

4 P Mode

5 Tv, Av, M, and C Modes

6 Playback Mode

7 Wi-Fi Functions

8 Set-Up Menu

9 Accessories

10 Appendix

Index



Still Images



- An orange AF frame is displayed with [AF-L] if the camera cannot focus when you press the shutter button halfway. No picture is taken, even if you press the shutter button all the way down.
- When no people or subjects are detected, when the subject is dark or has no contrast, or in extremely bright conditions, it may take longer to achieve focus, or correct focus may not be achieved.
- A blinking [Q] icon warns that images are more likely to be blurred by camera shake. In this case, mount the camera on a tripod or take other measures to keep it still.
- If your shots are dark despite the flash firing, move closer to the subject. For details on the flash range, see “Internal Flash Range Guide” (📖196).
- To reduce red-eye and to assist in focusing, the lamp may be lit when the shutter button is pressed halfway in low-light conditions.
- If the flash fires, vignetting may occur depending on the lens being used.
- A blinking [⚡] icon displayed when you attempt to shoot indicates that shooting is not possible until the flash has finished recharging. Shooting can resume as soon as the flash is ready, so either press the shutter button all the way down and wait, or release it and press it again.
- Although you can shoot again before the shooting screen is displayed, your previous shot may determine the focus, brightness, and colors used.



- The display shown right after shooting and before the saved image is shown will feature vignetting.
- You can change how long images are displayed after shots (📖47).

Movies



- The camera may become warm when shooting movies repeatedly over an extended period. This does not indicate damage.
- Keep your fingers away from the microphone (1) while shooting movies. Blocking the microphone may prevent audio from being recorded or may cause the recording to sound muffled.

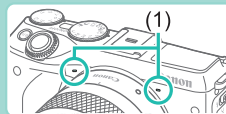

- Avoid touching camera controls other than the movie button and touch-screen controls when shooting movies. Sounds made by the camera will be recorded. Touch-screen control is recommended when adjusting settings while shooting movies.
- The sounds of the lens and camera operating are also recorded. This can be reduced by using an external microphone (sold separately) (📖157).
- If using a lens that supports Dynamic IS (📖78), the image display area changes and subjects are enlarged once movie recording begins to allow correction of significant camera shake. To shoot subjects at the same size shown before shooting, adjust the image stabilization setting (📖78).

Before Use

Basic Guide

Advanced Guide

1 Camera Basics

2 Auto Mode / Hybrid Auto Mode

3 Other Shooting Modes

4 P Mode

5 Tv, Av, M, and C Modes

6 Playback Mode

7 Wi-Fi Functions

8 Set-Up Menu

9 Accessories

10 Appendix

Index





- Audio is recorded in stereo.
- The focus automatically adjusts while shooting movies, which may cause the sound of the lens operating to be recorded. Using an external microphone (sold separately) may help reduce these lens sounds. If you do not want to record sound, go to the menu (📖32), select the [📷5] tab, and set [Sound recording] to [Disable].
- Go to the Menu (📖32), select the [📷5] tab, and set [Movie Servo AF] to [Disable] to keep the focus fixed during movie recording.
- Movies that take up over 4 GB of space in a single shooting are divided into multiple files. The movie shooting time on the shooting screen flashes for approximately 30 sec. before the movie reaches 4 GB in size. If you continue shooting and exceed 4 GB, the camera automatically creates a new movie file and flashing stops. Divided movie files cannot be automatically played in sequence. Each movie has to be viewed separately.

Scene Icons

▶ Still Images ▶ Movies

In [A+] and [A+] modes, shooting scenes determined by the camera are indicated by the icon displayed, and corresponding settings are automatically selected for optimal focusing, subject brightness, and color.

Background	When Shooting People		Icon Background Color
	People	In Motion	
Bright			Gray
Bright and Backlit			
With Blue Sky			Light Blue
Blue Sky and Backlit			
Spotlights		–	Dark Blue
Dark		–	
Dark, Using Tripod		–	

Background	When Shooting Other Subjects			Icon Background Color
	Other Subjects	In Motion	At Close Range	
Bright				Gray
Bright and Backlit				
With Blue Sky				Light Blue
Blue Sky and Backlit				
Sunsets		–	–	Orange
Spotlights		–		Dark Blue
Dark				
Dark, Using Tripod		–	–	

- The “In Motion” icons are not displayed when the self-timer (📖40) is on, when in [A+] mode, or when shooting a movie.
- The “When Shooting People” and “In Motion” icons are not displayed when the lens is set to MF or you are using a lens that cannot autofocus.



- Try shooting in [P] mode (📖60) if the scene icon does not match actual shooting conditions, or if it is not possible to shoot with your expected effect, color, or brightness.

Before Use

Basic Guide

Advanced Guide

1 Camera Basics

2 Auto Mode / Hybrid Auto Mode

3 Other Shooting Modes

4 P Mode

5 Tv, Av, M, and C Modes

6 Playback Mode

7 Wi-Fi Functions

8 Set-Up Menu

9 Accessories

10 Appendix

Index



On-Screen Frames

▶ Still Images ▶ Movies

A variety of frames are displayed once the camera detects subjects you are aiming the camera at.

- A white frame is displayed around the subject (or person's face) determined by the camera to be the main subject. The frame follows moving subjects within a certain range to keep them in focus.
- Press the shutter button halfway to focus. Once the scene is in focus, the frame will turn green.
- In [A+] mode, if you press the shutter button halfway when the subject is determined to be in motion, the frame will turn blue and the focus and brightness will be recalibrated (servo AF). Once back in focus, the frame will turn green.
- An orange AF frame is displayed with [O] if the camera cannot focus when you press the shutter button halfway.



- Try shooting in [P] mode (p. 60) if no frames are displayed, if frames are not displayed around desired subjects, or if frames are displayed on the background or similar areas.



- Set [AF auto switch] to [Disable] on the [4] tab to turn off servo AF. This turns off the "In Motion" icons (p. 39). [AF auto switch] is automatically set to [Disable] if the self-timer (p. 40) is set to anything besides [Off].



- To choose subjects to focus on, touch the desired subject on the screen. [Touch AF] is displayed, and the camera enters Touch AF mode.

Common, Convenient Features

▶ Still Images ▶ Movies

Using the Self-Timer

▶ Still Images ▶ Movies

With the self-timer, you can include yourself in group photos or other timed shots. The camera will shoot about 10 seconds after you press the shutter button.

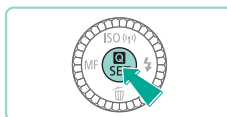

1 Configure the setting.

- Press the [Menu] button, choose [Self-timer] in the menu, and then choose [On] (p. 31).
- Once the setting is complete, [On] is displayed.

2 Shoot.

- For still images: press the shutter button halfway to focus on the subject, and then press it all the way down.
- For movies: press the movie button.

Before Use

Basic Guide

Advanced Guide

1 Camera Basics

2 Auto Mode / Hybrid Auto Mode

3 Other Shooting Modes

4 P Mode

5 Tv, Av, M, and C Modes

6 Playback Mode

7 Wi-Fi Functions

8 Set-Up Menu

9 Accessories

10 Appendix

Index



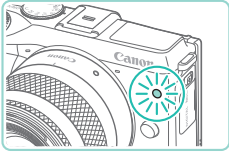

- Once you start the self-timer, the lamp will blink and the camera will play a self-timer sound.
- Two seconds before the shot, the blinking and sound will speed up. (The lamp will remain lit in case the flash fires.)
- To cancel shooting after you have triggered the self-timer, press the **[MENU]** button.
- To restore the original setting, choose **[C]** in step 1.

Using the Self-Timer to Avoid Camera Shake

► Still Images ► Movies

This option delays shutter release until about two seconds after you have pressed the shutter button. If the camera is unsteady while you are pressing the shutter button, it will not affect your shot.

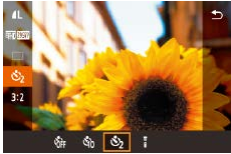

- Follow step 1 in “Using the Self-Timer” (40) and choose **[C]**.
- Once the setting is complete, **[C]** is displayed.
- Follow step 2 in “Using the Self-Timer” (40) to shoot.

Shooting by Touching the Screen (Touch Shutter)

► Still Images ► Movies

With this option, instead of pressing the shutter button, you can simply touch the screen and release your finger to shoot. The camera will focus on subjects and adjust image brightness automatically.



1 Enable touch-shutter function.

- Press the **[MENU]** button, choose [Touch Shutter] on the **[1]** tab, and then choose [Enable] (32).

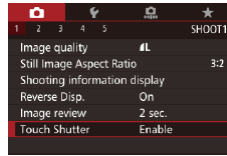

2 Shoot.

- Touch the subject on the screen to take the picture.
- To cancel touch shutter, choose [Disable] in step 1.



- If focus is not achieved, the AF frame turns orange and images cannot be taken.
- Even while the shot is displayed, you can prepare for the next shot by touching **[C]**.

Before Use

Basic Guide

Advanced Guide

1 Camera Basics

2 Auto Mode / Hybrid Auto Mode

3 Other Shooting Modes

4 P Mode

5 Tv, Av, M, and C Modes

6 Playback Mode

7 Wi-Fi Functions

8 Set-Up Menu

9 Accessories

10 Appendix

Index



Continuous Shooting

▶ Still Images ▶ Movies

In [A+] mode, hold the shutter button all the way down to shoot continuously.

For details on the continuous shooting speed, see “Drive, Self-timer System” (192).

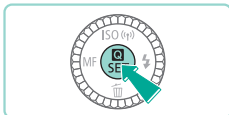

1 Configure the setting.

- Press the [Q] button, choose [] in the menu, and then choose [] (31).
- Once the setting is complete, [] is displayed.

2 Shoot.

- Hold the shutter button all the way down to shoot continuously.



- During continuous shooting, focus, exposure and color tone are locked at the position/level determined when you pressed the shutter button halfway.
- Cannot be used with the self-timer (40).
- Shooting may stop momentarily or continuous shooting may slow down depending on shooting conditions, camera settings, and the zoom position.
- As more shots are taken, shooting may slow down.
- There may be a delay after continuous shooting before you can shoot again, depending on the card type used and how many images were shot.
- Shooting may slow down if the flash fires.
- With Touch Shutter (41), the camera shoots continuously while you touch the screen. Focus, exposure and color tone during continuous shooting remain constant, after they are determined for the first shot.
- Images shown on-screen during continuous shooting differ from the actual images and may look out of focus. Also, depending on the lens used, the image displayed on-screen may appear darker during continuous shooting. However, the images are recorded with standard brightness.



- If the number of images that can be continually shot (burst image count) is 1 – 9, the number of continual shots left is displayed to the right of the total remaining shots at the top of the screen (174). This is not shown if you can shoot 10 or more continuous images.
- The number of continuous images you can shoot may decrease depending on the shooting scene or your camera settings.

Before Use

Basic Guide

Advanced Guide

1 Camera Basics

2 Auto Mode / Hybrid Auto Mode

3 Other Shooting Modes

4 P Mode

5 Tv, Av, M, and C Modes

6 Playback Mode

7 Wi-Fi Functions

8 Set-Up Menu

9 Accessories

10 Appendix

Index

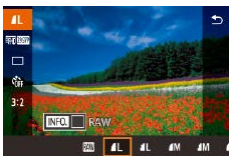
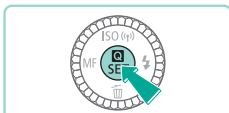

Image Customization Features

Changing Image Quality

► Still Images ► Movies

You can select the resolution (size) and quality (compression ratio) of your recorded images from a combination of 8 types. You can also define whether to save RAW images (📖43) or not. For guidelines on how many shots at each quality setting can fit on a memory card, see “Number of Shots per Memory Card” (📖195).



- Press the [QUAL] button, choose [L] in the menu, and choose the desired option (📖31).
- The option you configured is now displayed.
- To restore the original setting, repeat this process but choose [L].



- [L] and [S1] indicate the different levels of image quality caused by different compression rates. If using the same resolution, [L] will produce better image quality. [S1] will result in slightly lower image quality, but will enable you to record more images. [S2] and [S3] feature [L] image quality.
- Not available in [A] mode.

If selecting resolution based on paper size, use the following table as a guide (when using 3:2 aspect ratio).

L	A2 (16.5 x 23.4 in.)
M	A3 (11.7 x 16.5 in.)
S1	A4 (8.3 x 11.7 in.)
S2	3.5 x 5 in., 5 x 7 in., Postcard
S3	For e-mailing and similar purposes

Saving RAW Images

This camera can record images in JPEG and RAW formats.

JPEG Images	Images are processed in the camera for optimal image quality and compressed to reduce file size. However, the compression process is irreversible, and images cannot be restored to their original, unprocessed state. Image processing may also cause some loss of image quality.
RAW Images	The “raw” (unprocessed) data, recorded with essentially no loss of image quality from the camera’s image processing. The data cannot be used in this state for viewing on a computer or printing. You must first use the software (Digital Photo Professional) (📖158) to convert images to ordinary JPEG or TIFF files. Images can be adjusted with minimal loss of image quality.

Before Use

Basic Guide

Advanced Guide

1 Camera Basics

2 Auto Mode / Hybrid Auto Mode

3 Other Shooting Modes

4 P Mode

5 Tv, Av, M, and C Modes

6 Playback Mode

7 Wi-Fi Functions

8 Set-Up Menu

9 Accessories

10 Appendix

Index



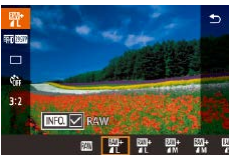
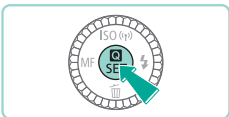

- Press the **[MENU]** button, and then choose **[RAW]** in the menu (📖31).
- If you want to save only the RAW image, select **[RAW]**.
- To save both a JPEG and a RAW image, select your desired image quality in the setting screen and then press the **[INFO]** button to add a **[✓]** to **[RAW]**. To go back to the original save method, remove the **[✓]** from **[RAW]**.



- When transferring RAW images (or RAW and JPEG images recorded together) to a computer, always use the dedicated software “EOS Utility” (📖158).



- For details on resolution and the number of shots that will fit on a card, see “Number of Shots per Memory Card” (📖195).
- The file extension for JPEG images is .JPG, and the extension for RAW images is .CR2. JPEG and RAW images recorded together will have the same image number in their filenames.
- Consult “Software” (📖158) to learn more about the Digital Photo Professional and EOS Utility software.

Using the Menu

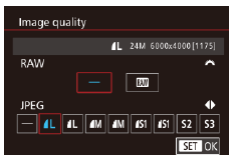
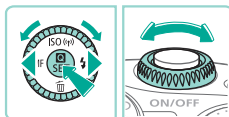

- Press the **[MENU]** button, choose **[Image quality]** on the **[CAMERA]** tab, and then press the **[MENU]** button (📖32).
- Turn the **[INFO]** dial to choose **[RAW]** in **[RAW]**. This will save a RAW file alongside the JPEG file. Select **[–]**, and the camera will only save the JPEG file.
- Press the **[◀][▶]** buttons or turn the **[INFO]** dial to change **[JPEG]**, selecting your preferred save resolution and compression ratio. Select **[–]**, and the camera will only save the RAW file.
- When finished, press the **[MENU]** button to return to the menu screen.



- You cannot set both the **[RAW]** and **[JPEG]** image setting to **[–]** at the same time.

Before Use

Basic Guide

Advanced Guide

1 Camera Basics

2 Auto Mode / Hybrid Auto Mode

3 Other Shooting Modes

4 P Mode

5 Tv, Av, M, and C Modes

6 Playback Mode

7 Wi-Fi Functions

8 Set-Up Menu

9 Accessories

10 Appendix

Index





Changing the Aspect Ratio

► Still Images ► Movies

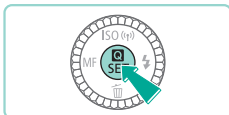

Change the image aspect ratio (ratio of width to height) as follows.



- Press the **[]** button, choose **[3:2]** in the menu, and choose the desired option (31).
- Once the setting is complete, the screen aspect ratio will be updated.
- To restore the original setting, repeat this process but choose **[3:2]**.



16:9	Used for display on widescreen HDTVs or similar display devices.
3:2	Same aspect ratio as 35mm film, used for printing images at 5 x 7-inch or postcard sizes.
4:3	Used for printing images at 3.5 x 5-inch or A-series sizes.
1:1	Square aspect ratio.





- Not available in **[]** mode.
- This can also be defined in the menu (32) by going to the **[1]** tab and choosing the [Still Image Aspect Ratio] option.

Changing Movie Image Quality



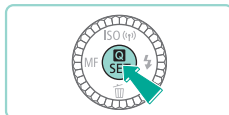

► Still Images ► Movies

You can set the quality (image size and frame rate) of movies. The frame rate (number of frames recorded per second) is determined by your video format settings (139). For guidelines on the maximum movie length at each level of image quality that will fit on a memory card, see “Recording Time per Memory Card” (196).



- Press the **[]** button, choose [Movie rec. size] in the menu, and choose the desired option (31).
- The option you configured is now displayed.

Video format set to [NTSC]

Image Quality	Resolution	Frame Rate	Details
[] 29.97P	1920 x 1080	29.97 fps	For shooting in Full HD. [] 23.98P enables shooting with a cinematic frame rate.
[] 23.98P	1920 x 1080	23.98 fps	
[] 59.94P	1280 x 720	59.94 fps	For shooting in HD
[] 29.97P	640 x 480	29.97 fps	For shooting in standard definition

Before Use

Basic Guide

Advanced Guide

1 Camera Basics

2 Auto Mode / Hybrid Auto Mode

3 Other Shooting Modes

4 P Mode

5 Tv, Av, M, and C Modes

6 Playback Mode

7 Wi-Fi Functions

8 Set-Up Menu

9 Accessories

10 Appendix

Index



Video format set to [PAL]

Image Quality	Resolution	Frame Rate	Details
[FHD 25.00P]	1920 x 1080	25.00 fps	For shooting in Full HD
[FHD 50.00P]	1280 x 720	50.00 fps	For shooting in HD
[VGA 25.00P]	640 x 480	25.00 fps	For shooting in standard definition



- [VGA 29.97P] and [VGA 25.00P] will display black bars on the left and right sides of the screen. [FHD 29.97P], [FHD 23.98P], [FHD 59.94P], [FHD 25.00P], and [FHD 50.00P] will display black bars on the top and bottom of the screen. The black bars indicate image areas not recorded.
- This can be set up in the menu (📖 32) by going to the [📷 5] tab and choosing the [Movie rec. size] option.

Using the Dual Axis Electronic Level

▶ Still Images ▶ Movies

An electronic level can be displayed as a guideline to ensure the camera is level from front to back and left to right.

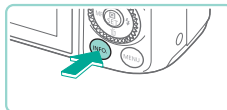

(1) (2)

1 Display the electronic level.

- Press the [INFO] button several times to display the electronic level.

2 Straighten the camera.

- (1) indicates the front-back orientation and (2) the left-right orientation.
- If the camera is tilted, move it so that the red line changes to green.



- If the electronic level is not displayed in step 1, go to the menu (📖 32) and check your settings in the [Shooting information display] option on the [📷 1] tab (📖 87).
- The electronic level is not displayed in [📷 3] mode or during movie recording.
- If you hold the camera vertically, the orientation of the electronic level will be updated automatically to match the camera orientation.
- Calibrate the electronic level if it seems ineffective in helping you level the camera (📖 139).

Before Use

Basic Guide

Advanced Guide

1 Camera Basics

2 Auto Mode / Hybrid Auto Mode

3 Other Shooting Modes

4 P Mode

5 Tv, Av, M, and C Modes

6 Playback Mode

7 Wi-Fi Functions

8 Set-Up Menu

9 Accessories

10 Appendix

Index



Customizing Camera Operation

Customize shooting functions on the [CAMERA] tab of the menu screen as follows.

For instructions on menu functions, see “Using the Menu Screen” (p.32).

Preventing the Red-Eye Reduction Lamp from Lighting Up

▶ Still Images ▶ Movies

You can deactivate the red-eye reduction lamp that lights up to reduce red-eye when the flash is used in low-light shots.

1 Access the [Flash Control] screen.

- Press the [MENU] button, choose [Flash Control] on the [CAMERA] tab, and then press the [INFO] button (p.32).

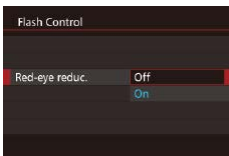

2 Configure the setting.

- Choose [Red-eye reduc.], and then choose [Off] (p.32).
- To restore the original setting, repeat this process but choose [On].

Changing the Image Display Period after Shots

▶ Still Images ▶ Movies

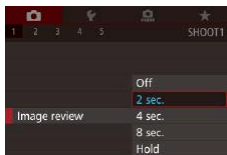

- Press the [MENU] button, choose [Image review] on the [CAMERA] tab, and then choose the desired option.
- To restore the original setting, repeat this process but choose [2 sec.].

2 sec.,	Displays images for the specified time. Even while the shot is displayed, you can take another shot by pressing the shutter button halfway again.
4 sec.,	
8 sec.	
Hold	Displays images until you press the shutter button halfway.
Off	No image display after shots.



- By pressing the [INFO] button while an image is displayed after shooting, you can switch the display information.

Before Use

Basic Guide

Advanced Guide

1 Camera Basics

2 Auto Mode / Hybrid Auto Mode

3 Other Shooting Modes

4 P Mode

5 Tv, Av, M, and C Modes

6 Playback Mode

7 Wi-Fi Functions

8 Set-Up Menu

9 Accessories

10 Appendix

Index



3

Other Shooting Modes

Shoot more effectively in various scenes, and take shots enhanced with unique image effects or captured using special functions

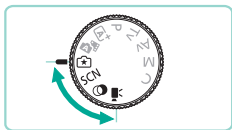







Shooting with Your Favorite Settings (Creative Assist)

Even if you don't know much about photography, you can select from on-screen options written in plain English to change the brightness, blur the background, and take pictures that are all your own. You can also save your favorite settings and easily load them back in later. Settings can even be applied from images shot in [SCN] mode.

When you display images shot in [SCN] mode, the camera can show you which [SCN] mode settings correspond to which camera settings, making it easier to step up to the Creative Auto shooting modes ([P], [Tv], [Av], or [M]).

The following options can be changed.

 Background	This lets you define how the background appears. The higher the value this is, the sharper the background gets. The lower the value, the more blurred the background.
 Brightness	This lets you adjust the image brightness. The higher this value, the brighter the image is.
 Contrast	This lets you adjust the contrast. The higher this is, the stronger the contrast between light and dark colors.
 Saturation	This lets you define how vivid the colors are. The higher this value, the more colorful the image; the lower it is, the more subdued and refined it becomes.
 Color tone	This lets you define the tone of the colors. Higher values result in warmer colors, while lower ones make the colors seem colder.
 Monochrome	You can choose from five color tones in Monochrome: [BW B/W], [S Sepia], [B Blue], [P Purple] and [G Green]. Set this to [OFF] to shoot in color. If this is set to anything besides [OFF], [Saturation] and [Color tone] are not available.

Before Use

Basic Guide

Advanced Guide

1 Camera Basics

2 Auto Mode / Hybrid Auto Mode

3 Other Shooting Modes

4 P Mode

5 Tv, Av, M, and C Modes

6 Playback Mode

7 Wi-Fi Functions

8 Set-Up Menu

9 Accessories

10 Appendix

Index





1 Enter [★] mode.

- Set the mode dial to [★].

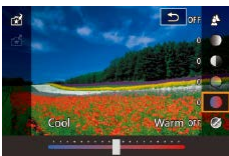

2 Configure the settings.

- Press the [☺] button, and then press the [▲][▼] buttons to choose the option. Press the [◀][▶] buttons or turn the [☀] [☾] dials to change options (📖31).
- Once everything is set up, press the [MENU] button to return to the shooting screen.

3 Shoot.



- When shooting with flash, [Background] cannot be set.



- Adjust the values of the options with [☀] [☾] shown next to them in the shooting screen by turning the [☀] [☾] dial. Press the [▲][▼] buttons to move the [☀] [☾], and select the option to adjust.
- Your settings are reset when the power is turned off, but set [Keep ★] setting] in [📷4] to [Enable] to save your settings even after turning off the camera.
- Touch [Q] at the upper right of the screen to show settings. You can also touch options in the settings screen to adjust them. Touch [↩] to return to the shooting screen.

Saving/Loading Settings

You can save your favorite settings and reload them later for repeated use.

Saving Settings



- Follow steps 1 and 2 in “Shooting with Your Favorite Settings (Creative Assist)” (📖49) to select [★] and set up your preferences.
- Press the [☺] button, press the [▲][▼] buttons to choose [★], and then press the [◀][▶] buttons or turn the [☀] [☾] dials to select where to save your settings.
- You can save up to six sets of settings.
- If you select a previously saved set, [INFO Compare] will be displayed. In this mode, when you press the [INFO] button, the previously saved settings will be displayed on-screen, letting you compare them with your new settings.
- Press the [☺] button; a confirmation screen is displayed. Press the [◀][▶] buttons or turn the [☀] dial to select [OK], and then press the [☺] button.

Before Use

Basic Guide

Advanced Guide

1 Camera Basics

2 Auto Mode / Hybrid Auto Mode

3 Other Shooting Modes

4 P Mode

5 Tv, Av, M, and C Modes

6 Playback Mode

7 Wi-Fi Functions

8 Set-Up Menu

9 Accessories

10 Appendix

Index



Loading



- Follow step 1 in “Shooting with Your Favorite Settings (Creative Assist)” (📖49) to select [★].
- Press the [ⓘ] button, press the [▲][▼] buttons to choose [★], and then press the [◀][▶] buttons or turn the [🔍][🔧] dials to select the settings to load.
- Press the [ⓘ] button to apply the saved settings.
- Select [-] and press the [ⓘ] button to go back without applying any settings.

Using Screen Settings

You can load settings from images shot in [★] mode and use them to shoot your own pictures.



- Follow step 1 in “Shooting with Your Favorite Settings (Creative Assist)” (📖49) to choose [★].
- Press the [▶] button to enter Playback mode, and then select an image shot in [★] for display.
- Press the [ⓘ] button, choose [★] in the menu, and press the [ⓘ] button again.
- The settings are applied and the camera goes into shooting mode.



- A message is displayed if you try to apply settings when the mode dial is set to anything besides [★]. The camera does not return to shooting mode. Turn the mode dial to [★] to apply the settings.
- Images shot in anything besides [★] mode will not be shown in [★] mode.

Playing Back Images

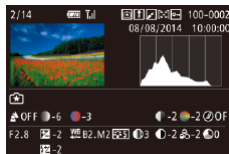

- When displaying images shot in [★] mode, press the [INFO.] button to display the screen shown to the left, letting you view the settings used when the picture was taken.

[★] Mode and Creative Zone Settings

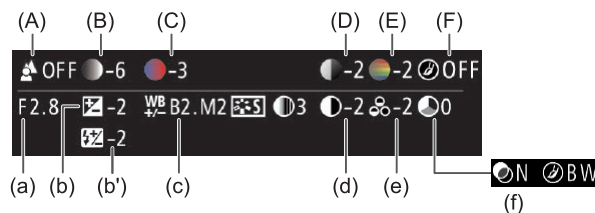

[★] mode setting	Creative Auto setting
(A) Background	(a) Aperture value (📖83)
(B) Brightness	(b) Exposure compensation (📖61) Flash time is (b') Flash exposure compensation (📖76)
(C) Color tone	(c) WB Correction (📖65)
(D) Contrast	(d) Picture Style contrast (📖68)
(E) Saturation	(e) Picture Style saturation (📖68)
(F) Monochrome	(f) Picture Style [🔍] filter and toning effect (📖68)

Before Use

Basic Guide

Advanced Guide

1 Camera Basics

2 Auto Mode / Hybrid Auto Mode

3 Other Shooting Modes

4 P Mode

5 Tv, Av, M, and C Modes

6 Playback Mode

7 Wi-Fi Functions

8 Set-Up Menu

9 Accessories

10 Appendix

Index



Specific Scenes

Choose a mode matching the shooting scene, and the camera will automatically configure the settings for optimal shots.



1 Enter [SCN] mode.

- Set the mode dial to [SCN].



2 Choose a shooting mode.

- Press the [MENU] button, choose [SCN] in the menu, and then choose a shooting mode (p.31).

3 Shoot.



Shooting Portraits (Portrait)

▶ Still Images ▶ Movies

- Take shots of people with a softening effect.



Shooting Landscapes (Landscape)

▶ Still Images ▶ Movies

- You can shoot wide-open landscapes with the focus close up or far away, letting you capture vivid skies and nature scenes.



Shooting Flowers and Small Objects (Close-up)

▶ Still Images ▶ Movies

- Take pictures of flowers and other objects from close up to make them look huge in your photos.
- To make small things appear even larger, use a macro lens (sold separately).
- Check the attached lens for its minimum focusing distance from the subject. The lens minimum focusing distance is measured from the [∞] (focal plane) mark on the top of the camera to the subject.



Shooting Moving Subjects (Sports)

▶ Still Images ▶ Movies

- When using a lens with “STM” in its name, the camera keeps focusing while shooting continuously. With other lenses, focus is locked at the position determined when you pressed the shutter button halfway.



Shooting Evening Scenes without Using a Tripod (Handheld NightScene)

▶ Still Images ▶ Movies

- Beautiful shots of evening scenes or portraits with evening scenery in the background, without the need to hold the camera very still (as with a tripod).
- A single image is created by combining consecutive shots, reducing camera shake and image noise.

Before Use

Basic Guide

Advanced Guide

1 Camera Basics

2 Auto Mode / Hybrid Auto Mode

3 Other Shooting Modes

4 P Mode

5 Tv, Av, M, and C Modes

6 Playback Mode

7 Wi-Fi Functions

8 Set-Up Menu

9 Accessories

10 Appendix

Index





- Subjects appear larger in [P] mode compared to other modes.
- In [P] and [P] modes, shots may look grainy because the ISO speed (📖62) is increased to suit the shooting conditions.
- Because the camera will shoot continuously in [P] mode, hold it steady while shooting.
- In [P] mode, excessive motion blur or certain shooting conditions may prevent you from obtaining the desired results.



- When you use a tripod for evening scenes, shooting in [A+] mode instead of [P] mode will give better results (📖35).

Taking Vivid Pictures of Food (Food)

▶ Still Images ▶ Movies

Any dish can look like a bright and colorful delight.

1 Choose [P].

- Follow steps 1 – 2 in “Specific Scenes” (📖51) and choose [P].



2 Change the color tone.

- Turn the [🌞] dial to change color tones.

3 Shoot.



- This mode may produce unsuitable color tones for human subjects.
- If you use flash, the Tone setting will switch to standard.

Image Effects (Creative Filters)

Add a variety of effects to images when shooting.

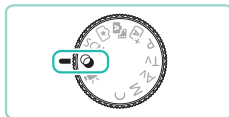

1 Enter [Q] mode.

- Set the mode dial to [Q].



2 Choose a shooting mode.

- Press the [Q] button, choose [HDR] in the menu, and then choose a shooting mode (📖31).

3 Shoot.

Before Use

Basic Guide

Advanced Guide

1 Camera Basics

2 Auto Mode / Hybrid Auto Mode

3 Other Shooting Modes

4 P Mode

5 Tv, Av, M, and C Modes

6 Playback Mode

7 Wi-Fi Functions

8 Set-Up Menu

9 Accessories

10 Appendix

Index



Shooting High-Contrast Scenes (High Dynamic Range)

▶ Still Images ▶ Movies

Three consecutive images are captured at different brightness levels each time you shoot, and the camera combines image areas with optimal brightness to create a single image. This mode can reduce the washed-out highlights and loss of detail in shadows that tend to occur in high-contrast shots.

1 Choose [HDR].

- Follow steps 1 – 2 in “Image Effects (Creative Filters)” (📖52) and choose [HDR].



2 Shoot.

- Hold the camera steady as you shoot. When you press the shutter button all the way down, the camera will take three shots and combine them.



- Excessive motion blur or certain shooting conditions may prevent you from obtaining the desired results.



- If excessive camera shake interferes with shooting, mount the camera on a tripod or take other measures to keep it still. Additionally, you should turn off image stabilization when using a tripod or other means to secure the camera (📖78).
- Any subject movement will make the image blurry.
- There will be a delay before you can shoot again, as the camera processes and combines the images.

Adding Artistic Effects



- Follow steps 1 – 2 in “Image Effects (Creative Filters)” (📖52) and choose [HDR].
- Turn the [🔧] dial to choose an effect level.
- A preview is shown of how your shot will look with the effect applied.

Natural	Images are natural and organic.
Art Standard	Images resemble paintings, with subdued contrast.
Art Vivid	Images resemble vivid illustrations.
Art Bold	Images resemble oil paintings, with bold edges.
Art Embossed	Images resemble old photos, with bold edges and dark ambiance.

Before Use

Basic Guide

Advanced Guide

1 Camera Basics

2 Auto Mode / Hybrid Auto Mode

3 Other Shooting Modes

4 P Mode

5 Tv, Av, M, and C Modes

6 Playback Mode

7 Wi-Fi Functions

8 Set-Up Menu

9 Accessories

10 Appendix

Index



Shooting with a Fish-Eye Lens Effect (Fish-Eye Effect)

▶ Still Images ▶ Movies

Shoot with the distorting effect of a fish-eye lens.

1 Choose [📷].

- Follow steps 1 – 2 in “Image Effects (Creative Filters)” (📖52) and choose [📷].



2 Choose an effect level.

- Turn the [🔆] dial to choose an effect level.
- A preview is shown of how your shot will look with the effect applied.

3 Shoot.



- Try taking some test shots first, to make sure you obtain the desired results.

Shooting Oil Painting-like Photos (Art Bold Effect)

▶ Still Images ▶ Movies

Emphasize the three-dimensional shape of the subject for an oil-like effect.

1 Choose [🎨].

- Follow steps 1 – 2 in “Image Effects (Creative Filters)” (📖52) and choose [🎨].



2 Choose an effect level.

- Turn the [🔆] dial to choose an effect level.
- A preview is shown of how your shot will look with the effect applied.

3 Shoot.

Shooting Watercolor-like Photos (Water Painting Effect)

▶ Still Images ▶ Movies

You can shoot pictures with a light, soft watercolor-like effect.

1 Choose [🎨].

- Follow steps 1 – 2 in “Image Effects (Creative Filters)” (📖52) and choose [🎨].



2 Choose an effect level.

- Turn the [🔆] dial to choose an effect level.
- A preview is shown of how your shot will look with the effect applied.

3 Shoot.

Before Use

Basic Guide

Advanced Guide

1 Camera Basics

2 Auto Mode / Hybrid Auto Mode

3 Other Shooting Modes

4 P Mode

5 Tv, Av, M, and C Modes

6 Playback Mode

7 Wi-Fi Functions

8 Set-Up Menu

9 Accessories

10 Appendix

Index



Shots Resembling Miniature Models (Miniature Effect)

▶ Still Images ▶ Movies

Creates the effect of a miniature model, by blurring image areas above and below your selected area.

You can also make movies that look like scenes in miniature models by choosing the playback speed before the movie is recorded. People and objects in the scene will move quickly during playback. Note that sound is not recorded.

1 Choose [EFFECT].

- Follow steps 1 – 2 in “Image Effects (Creative Filters)” (p.52) and choose [EFFECT].
- A white frame is displayed, indicating the image area that will not be blurred.



2 Choose the area to keep in focus.

- Press the [ZOOM] button.
- Press the [INFO] button to resize the frame, and then press the [ZOOM] buttons or turn the [DIAL] dial to move it.

3 For movies, choose the movie playback speed.

- Turn the [SPEED] dial to choose the speed.

4 Return to the shooting screen and shoot.

- Press the [SHOOT] button to return to the shooting screen, and then shoot.

Playback Speed and Estimated Playback Time (for One-Minute Clips)

Speed	Playback Time
5x	Approx. 12 sec.
10x	Approx. 6 sec.
20x	Approx. 3 sec.



- Try taking some test shots first, to make sure you obtain the desired results.



- To switch the orientation of the frame to vertical, press the [LEFT][RIGHT] buttons in step 2. To move the frame, press the [LEFT][RIGHT] buttons again. To return the frame to horizontal orientation, press the [UP][DOWN] buttons.
- Holding the camera vertically will change the orientation of the frame.
- Movie quality depends on the video format (p.139) and still-image aspect ratio (p.45).
- If the video system is set to [NTSC], the quality is [HD 29.97P] for the [16:9] aspect ratio and [VGA 29.97P] for the [4:3] aspect ratio.
- If the video system is set to [PAL], the quality is [HD 25.00P] for the [16:9] aspect ratio and [VGA 25.00P] for the [4:3] aspect ratio.



- You can also move the frame by touching or dragging across the screen.

Before Use

Basic Guide

Advanced Guide

1 Camera Basics

2 Auto Mode / Hybrid Auto Mode

3 Other Shooting Modes

4 P Mode

5 Tv, Av, M, and C Modes

6 Playback Mode

7 Wi-Fi Functions

8 Set-Up Menu

9 Accessories

10 Appendix

Index



Shooting with a Toy Camera Effect (Toy Camera Effect)

▶ Still Images ▶ Movies

This effect makes images resemble shots from a toy camera by vignetting (darker, blurred image corners) and changing the overall color.

1 Choose [📷].

- Follow steps 1 – 2 in “Image Effects (Creative Filters)” (📖 52) and choose [📷].



2 Choose a color tone.

- Turn the [🌞] dial to choose a color tone.
- A preview is shown of how your shot will look with the effect applied.

3 Shoot.

Standard	Shots resemble toy camera images.
Warm	Images have a warmer tone than with [Standard].
Cool	Images have a cooler tone than with [Standard].



- Try taking some test shots first, to make sure you obtain the desired results.

Shooting with a Soft Focus Effect

▶ Still Images ▶ Movies

This function allows you to shoot images as if a soft focus filter were attached to the camera. You can adjust the effect level as desired.

1 Choose [👤].

- Follow steps 1 – 2 in “Image Effects (Creative Filters)” (📖 52) and choose [👤].



2 Choose an effect level.

- Turn the [🌞] dial to choose an effect level.
- A preview is shown of how your shot will look with the effect applied.

3 Shoot.



- Try taking some test shots first, to make sure you obtain the desired results.

Before Use

Basic Guide

Advanced Guide

1 Camera Basics

2 Auto Mode / Hybrid Auto Mode

3 Other Shooting Modes

4 P Mode

5 Tv, Av, M, and C Modes

6 Playback Mode

7 Wi-Fi Functions

8 Set-Up Menu

9 Accessories

10 Appendix

Index



Shooting in Monochrome (Grainy B/W)

▶ Still Images ▶ Movies

You can take pictures with a rough monochrome feel.

1 Choose [E.L].

- Follow steps 1 – 2 in “Image Effects (Creative Filters)” (📖52) and choose [E.L].

2 Choose an effect level.

- Turn the [🔆] dial to choose an effect level.
- A preview is shown of how your shot will look with the effect applied.

3 Shoot.



Shooting Movies in Movie Mode

▶ Still Images ▶ Movies

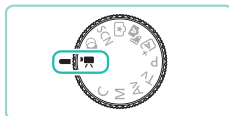

1 Enter [M] mode.

- Set the mode dial to [M].
- Displays black bars on the top and bottom edges of the screen. The black bars indicate image areas not recorded.
- Press the [Q] button, choose [M] in the menu, and then choose [M] (📖31).

2 Configure the settings to suit the movie (📖177).

3 Shoot.

- Press the movie button.
- To stop movie recording, press the movie button again.



- If using a lens that supports Dynamic IS (📖78), selecting [M] mode adjusts the range displayed on-screen to make the subject larger.



- Touch the [AF] button before or during shooting to show the [MF] icon and use a fixed focal position.
- Touch [SERVO AF] on the screen before or during shooting to switch between automatic or fixed focus position when shooting. (The [O] on the upper-left corner of the [SERVO AF] icon turns green when using automatic focus position adjustment.) This is not displayed when [Movie Servo AF] (📖39) is set to [Disable] on the [M5] tab in the menu.

Before Use

Basic Guide

Advanced Guide

1 Camera Basics

2 Auto Mode / Hybrid Auto Mode

3 Other Shooting Modes

4 P Mode

5 Tv, Av, M, and C Modes

6 Playback Mode

7 Wi-Fi Functions

8 Set-Up Menu

9 Accessories

10 Appendix

Index



Shooting Still Images during Movie Recording

▶ Still Images ▶ Movies

Shoot still images during movie recording as follows.



1 While shooting a movie, focus on a subject.

- Press the shutter button halfway down to readjust the focus and exposure. (The camera will not beep.)
- Movie recording will continue.

2 Shoot.

- Press the shutter button all the way down.
- Your shot will be recorded.



- Shooting still images during movie recording may not be possible when the memory card's recording speed is slow, or when there is not enough free internal memory.
- Shutter sounds will be heard in the movie.
- An orange AF frame is displayed with [O] if the camera cannot focus when you press the shutter button halfway. No picture is taken, even if you press the shutter button all the way down.
- The flash does not fire.
- Movie recording may stop if shooting still images fills up the internal memory.



- In the menu (32), set [AF w/ shutter button during] on the [5] tab to [Disable] to turn off focusing when the shutter button is pressed halfway when shooting movies.
- In [29.97P], [23.98P], [59.94P], [25.00P], and [50.00P] (16:9 aspect ratio) modes, still photos will be saved in the [16:9] aspect ratio.
- In [29.97P] and [25.00P] (4:3 aspect ratio) modes, still photos will be saved in the [4:3] aspect ratio.

Locking or Changing Image Brightness

▶ Still Images ▶ Movies

Before or during recording, you can lock the exposure, or change it in 1/3-stop increments within a range of -3 to +3 stops.



- Press the [X] button to lock the exposure. To unlock the exposure, press the [X] button again.
- Turn the exposure compensation dial to adjust the brightness as you watch the screen.



- You can also lock and unlock the exposure by touching [X] on the screen.
- During shooting, touch the exposure compensation bar at the bottom of the screen and then touch the [L] [R] buttons to change the exposure.
- Exposures adjusted by changing the exposure correction with the touch screen will not feature the same exposure correction settings as when using the exposure compensation dial. Look at the screen to verify the exposure.

Before Use

Basic Guide

Advanced Guide

1 Camera Basics

2 Auto Mode / Hybrid Auto Mode

3 Other Shooting Modes

4 P Mode

5 Tv, Av, M, and C Modes

6 Playback Mode

7 Wi-Fi Functions

8 Set-Up Menu

9 Accessories

10 Appendix

Index



Sound Settings

▶ Still Images ▶ Movies

Adjusting the Recording Volume

In [Auto], although the recording level (volume) is adjusted automatically, you can set the level manually to suit the shooting scene.

1 Access the [Sound recording] screen.

- Press the [MENU] button, choose [Sound recording] on the [5] tab, and then press the [OK] button (32).



2 Configure the settings.

- Select [Sound recording] and press the [OK] button. In the next screen, press the [▲][▼] buttons or turn the [OK] dial to select [Manual] and then press the [OK] button.
- Press the [▼] button to choose [Rec. level]. Press the [OK] button. In the next screen, press the [▲][▼] buttons or turn the [OK] dial to define the level and then press the [OK] button.
- To restore the original setting, repeat this process but choose [Auto].

Turning Off the Wind Filter

Noise caused by strong wind can be reduced. However, the recording may sound unnatural when this option is used when there is no wind. You can turn off the wind filter for these situations.

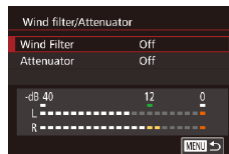

- Follow step 1 in “Adjusting the Recording Volume” (59) to display the [Sound recording] screen.
- Choose [Wind filter/Attenuator] and press the [OK] button.
- Choose [Wind Filter] and then [Off].

Using the Attenuator

The attenuator can help reduce sound clipping in loud environments. However, this reduces the recording volume for scenes shot in quieter environments.

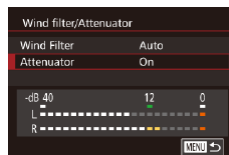

- Follow step 1 in “Adjusting the Recording Volume” (59) to display the [Sound recording] screen.
- Choose [Wind filter/Attenuator] and press the [OK] button.
- Choose [Attenuator], and then choose [On].

Before Use

Basic Guide

Advanced Guide

1 Camera Basics

2 Auto Mode / Hybrid Auto Mode

3 Other Shooting Modes

4 P Mode

5 Tv, Av, M, and C Modes

6 Playback Mode

7 Wi-Fi Functions

8 Set-Up Menu

9 Accessories

10 Appendix

Index



4

P Mode

More discerning shots, in your preferred shooting style

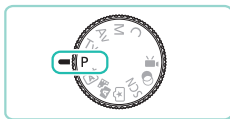

- Instructions in this chapter apply to the camera with the mode dial set to **[P]** mode.
- **[P]**: Program AE; AE: Auto Exposure
- Before using a function introduced in this chapter in modes other than **[P]**, make sure the function is available in that mode (📖177).

Shooting in Program AE ([P] Mode)

▶ Still Images ▶ Movies

You can customize many function settings to suit your preferred shooting style.



1 Enter **[P]** mode.

- Set the mode dial to **[P]**.

2 Customize the settings as desired (📖61 – 📖81), and then shoot.



- Movies can be recorded in **[P]** mode as well, by pressing the movie button. However, some menu (📖31, 📖32) settings may be automatically adjusted for movie recording.

Before Use

Basic Guide

Advanced Guide

1 Camera Basics

2 Auto Mode / Hybrid Auto Mode

3 Other Shooting Modes

4 P Mode

5 Tv, Av, M, and C Modes

6 Playback Mode

7 Wi-Fi Functions

8 Set-Up Menu

9 Accessories

10 Appendix

Index



Adjusting Shooting Functions from a Single Screen

The INFO. Quick Control screen lets you quickly adjust options using a single screen of functions.



1 Access the INFO. Quick Control screen.

- Press the [INFO.] button repeatedly to display the INFO. Quick Control screen.

2 Select a function to adjust.

- Press the [▲][▼][◀][▶] buttons to choose a function and display a description.
- You can also turn the [☀][☾] dials to access functions.



- The adjustable functions differ depending on the shooting mode.



- Some functions open up another options screen when you choose them and press the [OK] button. Options labeled with a [INFO.] icon in the second screen can be configured by pressing the [INFO.] button. Press the [OK] button to return to the INFO. Quick Control screen.



- Touch a function in the INFO. Quick Control screen, and then touch it again to go to the adjustment screen for the function. Touch [Return] to return to the previous screen.
- Touch [Close] on the upper right of the function description to close the description display.

Image Brightness (Exposure)

Adjusting Image Brightness (Exposure Compensation)

▶ Still Images ▶ Movies

The standard exposure set by the camera can be adjusted in 1/3-stop increments, in a range of -3 to +3.



- As you watch the screen, turn the exposure compensation dial to adjust brightness.

Locking Image Brightness / Exposure (AE Lock)

▶ Still Images ▶ Movies

Before shooting, you can lock the exposure, or you can specify focus and exposure separately.



1 Lock the exposure.

- Aim the camera at the subject to shoot with the exposure locked, and then press the [*] button.
- [*] is displayed, and the exposure is locked.
- Press the [*] button again to cancel and remove the [*] icon.

2 Compose the shot and shoot.

Before Use

Basic Guide

Advanced Guide

1 Camera Basics

2 Auto Mode / Hybrid Auto Mode

3 Other Shooting Modes

4 P Mode

5 Tv, Av, M, and C Modes

6 Playback Mode

7 Wi-Fi Functions

8 Set-Up Menu

9 Accessories

10 Appendix

Index





- AE: Auto Exposure
- After the exposure is locked, you can adjust the combination of shutter speed and aperture value by turning the [☀️] dial (Program Shift).

Changing the Metering Method

▶ Still Images ▶ Movies

Adjust the metering method (how brightness is measured) to suit shooting conditions as follows.



- Press the [M] button, choose [M] in the menu, and choose the desired option (31).
- The option you configured is now displayed.

	Evaluative	For typical shooting conditions, including backlit shots. Automatically adjusts standard exposure to match the shooting conditions.
	Partial metering	Effective when the background is much brighter than the subject due to backlighting, etc. Metering is restricted to within the circular frame (Spot AE Point frame) displayed in the center of the screen.
	Spot	For metering a specific spot of the subject or scene. Metering restricted to within the circular frame (Spot AE Point frame), displayed in the center of the screen.
	Center Weighted Avg.	Determines the average brightness of light across the entire image area, calculated by treating brightness in the central area as more important.



- In [M] mode, exposure is locked when you press the shutter button halfway. In [M] [M] [M] modes, the exposure is not locked when you press the shutter button halfway and is not determined until the moment you shoot the picture.
- This can also be adjusted by choosing [Metering mode] on the [M] tab of the menu (32).

Changing the ISO Speed

▶ Still Images ▶ Movies



- Press the [▲] button, turn the [M] dial to choose the ISO speed, and then press the [M] button.
- The option you configured is now displayed.

AUTO	Automatically adjusts the ISO speed to suit the shooting mode and conditions.
100, 125, 160, 200	For shooting outdoors in fair weather.
250, 320, 400, 500, 640, 800	For shooting in cloudy conditions, or at twilight.
1000, 1250, 1600, 2000, 2500, 3200, 4000, 5000, 6400, 8000, 10000, 12800	For shooting night scenes, or in dark rooms.

Shooting sensitivity increases as the ISO speed goes up. The lower the speed, the lower the sensitivity.

Before Use

Basic Guide

Advanced Guide

1 Camera Basics

2 Auto Mode / Hybrid Auto Mode

3 Other Shooting Modes

4 P Mode

5 Tv, Av, M, and C Modes

6 Playback Mode

7 Wi-Fi Functions

8 Set-Up Menu

9 Accessories

10 Appendix

Index





- To view the automatically determined ISO speed when you have set the ISO speed to [AUTO], press the shutter button halfway.
- Although choosing a lower ISO speed may reduce image graininess, there may be a greater risk of subject and camera shake in some shooting conditions.
- Choosing a higher ISO speed will increase shutter speed, which may reduce subject and camera shake and increase the flash range. However, shots may look grainy.
- This can also be adjusted by going to [ISO speed] on the [CAMERA] tab of the menu (83) and selecting [ISO speed].
- If you want to select speeds up to [H] (equivalent to ISO 25600), go to the menu (83), choose [C.Fn 1:Exposure] from the [CAMERA] tab, and set [ISO expansion] to [1:On] (88).

Adjusting ISO Auto Settings

▶ Still Images ▶ Movies

You can select the maximum ISO speed used when ISO speed is set to [AUTO].

1 Access the setting screen.

- Press the [MENU] button, choose [ISO speed] on the [CAMERA] tab, and then press the [OK] button (83).

2 Configure the settings.

- Choose [ISO Auto] and then choose an option (83).

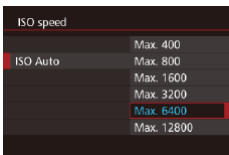

Auto Exposure Bracketing (AEB Shooting)

▶ Still Images ▶ Movies

Three consecutive images are captured at different exposure levels (standard exposure, underexposure, and then overexposure) each time you shoot. You can adjust the amount of underexposure and overexposure (relative to standard exposure) from -2 to +2 stops in 1/3-stop increments.

1 Access the setting screen.

- Press the [MENU] button, choose [AEB] on the [CAMERA] tab, and then press the [OK] button (83).

2 Configure the settings.

- Press the [◀▶] buttons or turn the [DISP] dial to adjust values.
- To cancel the AEB function, follow steps 1 – 2 to set the AEB correction value to 0.

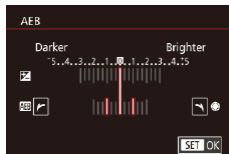

- AEB cannot be used when the flash is not set to [ON], Multi Shot Noise Reduction is on (80), or when continuous or bulb shooting is active.



- If exposure compensation is already in use (61), the value specified for that function is treated as the standard exposure level for this function. In step 2, you can turn the exposure compensation dial on the screen to adjust the correction.

Before Use

Basic Guide

Advanced Guide

1 Camera Basics

2 Auto Mode / Hybrid Auto Mode

3 Other Shooting Modes

4 P Mode

5 Tv, Av, M, and C Modes

6 Playback Mode

7 Wi-Fi Functions

8 Set-Up Menu

9 Accessories

10 Appendix

Index



Auto Correction of Brightness and Contrast (Auto Lighting Optimizer)

▶ Still Images ▶ Movies

If the image comes out dark or the contrast is low, the brightness and contrast can be corrected automatically.

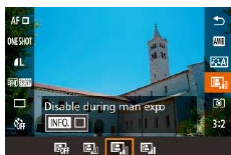

- Press the **[MENU]** button, choose **[ALO]** in the menu, and choose the desired option (📖31).



- Depending on the shooting conditions, noise may increase.
- When the effect of the Auto Lighting Optimizer is too strong and the image becomes excessively bright, set it to [Low] or [Disable].
- If a setting other than [Disable] is set and you use exposure compensation or flash exposure compensation to darken the exposure, the image may still come out bright, or the effect of AEB-based exposure compensation may be reduced. If you want a darker exposure, set this function to [Disable].



- The Auto Lighting Optimizer can also be set with the [Auto Lighting Optimizer] option on the **[CAMERA]** tab of the menu (📖32).

Shooting Bright Subjects (Highlight Tone Priority)

▶ Still Images ▶ Movies

The camera can improve gradation on the high-brightness spectrum to reduce clipped whites on the subject.

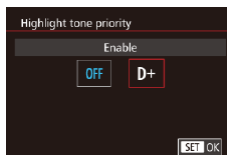

- Press the **[MENU]** button, choose [Highlight tone priority] on the **[CAMERA]** tab, and choose [D+] (📖32).



- Setting this to [D+] makes ISO speeds below 160 unavailable. The Auto Lighting Optimizer will also be set to [Disable].

Before Use

Basic Guide

Advanced Guide

1 Camera Basics

2 Auto Mode / Hybrid Auto Mode

3 Other Shooting Modes

4 P Mode

5 Tv, Av, M, and C Modes

6 Playback Mode

7 Wi-Fi Functions

8 Set-Up Menu

9 Accessories

10 Appendix

Index



Image Colors

Adjusting White Balance

▶ Still Images ▶ Movies

By adjusting white balance (WB), you can make image colors look more natural for the scene you are shooting.



- Press the **[WB]** button, choose **[AWB]** in the menu, and choose the desired option (📖31).
- The option you configured is now displayed.

[WB] Auto	Automatically sets the optimal white balance for the shooting conditions.
Day Light	For shooting outdoors in fair weather.
Shade	For shooting in the shade.
Cloudy	For shooting in cloudy weather or at twilight.
Tungsten light	Tungsten
White fluorescent light	For shooting under white fluorescent lighting.
Flash	For shooting with the flash.
Custom	For manually setting a custom white balance.

Custom White Balance

For image colors that look natural under the light in your shot, adjust white balance to suit the light source where you are shooting. Set the white balance under the same light source that will illuminate your shot.

1 Shoot a white object.

- Fill the LCD monitor screen with a sheet of white paper, etc.
- Focus manually and shoot (📖74).

2 Select [Custom White Balance].

- On the **[CAMERA]** tab, select [Custom White Balance] and then press the **[WB]** button.
- The custom white balance selection screen will appear.

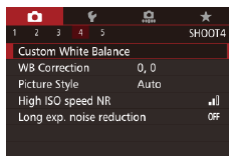

3 Load the white data.

- Select the image that was captured in step 1 and then press **[WB]**.
- In the confirmation screen, press the **[OK]** button or turn the **[DIAL]** to choose [OK], and then press the **[WB]** button.
- Press the **[MENU]** button to close the menu.

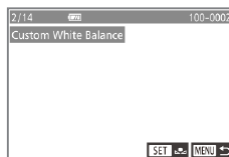

4 Select **[WB]**.

- Follow the steps in “Adjusting White Balance” (📖65) to select **[WB]**.



Before Use

Basic Guide

Advanced Guide

1 Camera Basics

2 Auto Mode / Hybrid Auto Mode

3 Other Shooting Modes

4 P Mode

5 Tv, Av, M, and C Modes

6 Playback Mode

7 Wi-Fi Functions

8 Set-Up Menu

9 Accessories

10 Appendix

Index





- If the exposure obtained in step 1 is too bright or dark, a correct white balance may not be obtained.
- A message will appear if you use an image in step 3 that is not suitable for loading white data. Choose [Cancel] to select another image. Choose [OK], and the chosen image will be used to load white data, although this may not produce a suitable white balance.
- If you see an [Unselectable image.] message in step 3, select [OK] to close the message and select another image.
- If you see a [Set WB to "☐"] message in step 3, press the [☐] button to return to the menu screen and then select [☐].



- Instead of a white object, a gray chart or 18% gray reflector (commercially available) can produce a more accurate white balance.
- The current white balance settings do not matter at the time you shoot the image in step 1.

Manually Correcting White Balance

▶ Still Images ▶ Movies

You can manually correct white balance. This adjustment can match the effect of using a commercially available color temperature conversion filter or color-compensating filter.



1 Configure the setting.

- Follow the steps in "Adjusting White Balance" (📖65) to choose the white balance option.
- Turn the [☀️] dial to adjust the correction level for B and A.

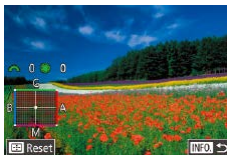

2 Configure advanced settings.

- To configure more advanced settings, press the [INFO.] button and adjust the correction level by turning the [☀️][☀️] dials.
- To reset the correction level, press the [☐] button.
- Press the [☐] button to complete the setting.



- Once you set a correction value, it will be retained even after changing the white balance value in step 1.



- B: blue; A: amber; M: magenta; G: green
- One level of blue/amber correction is equivalent to about 5 mireds on a color temperature conversion filter. (Mired: Color temperature unit representing color temperature conversion filter density)
- This can also be adjusted by going to the menu (📖32) and choosing [WB Correction] on the [📷4] tab.



- You can also choose the correction level by touching or dragging the bar in step 1 or the frame in step 2.
- You can also access the screen in step 2 by touching [INFO.] in step 1.

Before Use

Basic Guide

Advanced Guide

1 Camera Basics

2 Auto Mode / Hybrid Auto Mode

3 Other Shooting Modes

4 P Mode

5 Tv, Av, M, and C Modes

6 Playback Mode

7 Wi-Fi Functions

8 Set-Up Menu

9 Accessories

10 Appendix

Index



Using Your Favorite Shades (Picture Style)



► Still Images ► Movies

Picture Styles allow you to use your preferred color hues in defined picture and subject conditions. There are 6 types of Picture Styles available and all are fully adjustable.



- Press the **[P]** button, choose **[P-A]** in the menu, and choose the desired option (📖31).

[P-A] Auto	The color tone will be adjusted automatically to suit the scene. The colors will look vivid, especially for blue skies, greenery, and sunsets in nature, outdoor, and sunset scenes.
[P-S] Standard	The image looks vivid, sharp, and crisp. Suitable for most scenes.
[P-P] Portrait	For smooth skin tones. The image looks softer. Suited for close-up portraits. Change the [Color tone] to adjust skin tones (📖68).
[P-L] Landscape	For vivid blues and greens, and very sharp and crisp images. Effective for impressive landscapes.
[P-N] Neutral	For images to be processed by computer later. Natural color tones and a subdued look.
[P-F] Faithful	For images to be processed by computer later. When the subject is captured under a color temperature of 5200K, the color is adjusted colorimetrically to match the subject's color. Vivid colors are suppressed for a subdued look.
[P-M] Monochrome	Creates black-and-white images.

  	User Define	You can add a basic style such as [Portrait] or [Landscape], a Picture Style file, etc., and adjust it as desired (📖67).
---	-------------	--



- If no Picture Style is added to **[P-1]**, **[P-2]** or **[P-3]**, these settings will be the same as the [Auto] default settings.
- This can also be adjusted by going to the menu (📖32) and choosing [Picture Style] on the **[P-4]** tab.

Before Use

Basic Guide

Advanced Guide

1 Camera Basics

2 Auto Mode / Hybrid Auto Mode

3 Other Shooting Modes

4 P Mode

5 Tv, Av, M, and C Modes

6 Playback Mode

7 Wi-Fi Functions

8 Set-Up Menu

9 Accessories







10 Appendix

Index



Adjusting Picture Styles

The following settings can be adjusted for each Picture Style.

 Sharpness	Adjusts the sharpness of the subject. Lower values produce softer (more blurred) effects; higher values produce sharper results.
 Contrast	Adjusts the contrast. Lower values produce weaker contrast; higher values produce stronger contrast.
 Saturation* ¹	Adjusts the color saturation in the image. Lower values produce shallower colors; higher values produce deeper colors.
 Color tone* ¹	Adjusts skin color tone. Lower values produce redder hues; higher values produce colors that are more yellow.
 Filter effect* ²	Emphasizes white clouds in monochrome images, or the greens of trees. N: Normal black-and-white image with no filter effects. Ye: The blue sky will look more natural, and the white clouds will look crisper. Or: The blue sky will look slightly darker. Sunsets will look more brilliant. R: The blue sky will look quite dark. Fall leaves will look crisper and brighter. G: Skin tones and lips will appear muted. Green tree leaves will look crisper and brighter.
 Toning effect* ²	The following monochrome colors can be selected: [N:None], [S:Sepia], [B:Blue], [P:Purple] or [G:Green].

*1 Not available in  mode.

*2 Only available in  mode.

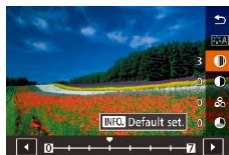

- Increasing the [Contrast] will make the [Filter effect] more pronounced.

1 Access the setting screen.

- Follow the steps in “Using Your Favorite Shades (Picture Styles)” (p.67) to select the Picture Style you want.
- Press the **[INFO]** button.

2 Configure the settings.

- Press the **[▲]**/**[▼]** buttons to choose an item; then, press the **[◀]**/**[▶]** buttons or turn the **[◂]**/**[▸]** dials to choose an option.
- Press the **[INFO]** button to undo any changes.
- When finished, press the **[Q]** button.

Before Use

Basic Guide

Advanced Guide

1 Camera Basics

2 Auto Mode / Hybrid Auto Mode

3 Other Shooting Modes

4 P Mode

5 Tv, Av, M, and C Modes

6 Playback Mode

7 Wi-Fi Functions

8 Set-Up Menu

9 Accessories

10 Appendix

Index



Saving Customized Picture Styles

Basic styles like [P1] and [P2] can be adjusted to your liking and saved for later. You can save multiple Picture Styles with different settings for parameters such as sharpness and contrast.



1 Select a Picture Style to save.

- Follow the steps in “Using Your Favorite Shades (Picture Styles)” (167) to select [P1], [P2] or [P3].

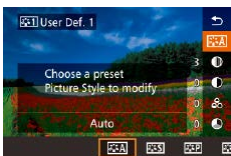

2 Select the base Picture Style.

- Press the [INFO] button.
- Press the [Left][Right] buttons or turn the [Sun][Globe] dials to select the Picture Style that will serve as a base.

3 Adjust the style.

- Press the [Up][Down] buttons to select the item to adjust; then, press the [Left][Right] buttons or turn the [Sun][Globe] dials to adjust the item.
- When finished, press the [Menu] button.



- In step 2, you can also select styles added to the camera using the EOS Utility software (158).

Shooting Range and Focusing

Selecting the AF Method

▶ Still Images ▶ Movies

You can change the AF (autofocus) method to use as necessary for your scene and subject.



- Press the [Menu] button, choose [AF] in the menu, and then choose the desired option (132).



- When the subject is dark or has no contrast, in extremely bright conditions, or with some EF and EF-S lenses, it may take longer to achieve focus, or correct focus may not be achieved. For more information about lenses, refer to the Canon website.



- This can also be adjusted by going to the menu (132) and choosing [AF method] on the [2] tab.

1-Point AF

- Focus using a single frame. Effective for reliable focusing.
- Press the shutter button halfway down. Once the scene is in focus, the frame will turn green.

Before Use

Basic Guide

Advanced Guide

1 Camera Basics

2 Auto Mode / Hybrid Auto Mode

3 Other Shooting Modes

4 P Mode

5 Tv, Av, M, and C Modes

6 Playback Mode

7 Wi-Fi Functions

8 Set-Up Menu

9 Accessories

10 Appendix

Index





- You can change the frame's position (📖71). To compose shots so that subjects are positioned at the edge or in a corner without changing the frame position, first aim the camera to capture the subject in an AF frame, and then hold the shutter button halfway down. As you continue to hold the shutter button halfway, recompose the shot as desired, and then press the shutter button all the way down (Focus Lock).
- Follow steps 2 – 4 in "Shooting in Manual Focus Mode" (📖74) to magnify the position of the AF frame. The touch shutter does not work while using this operation.

📷+Tracking

- After you aim the camera at the subject, a white frame is displayed around the face of the person determined by the camera to be the main subject. You can also choose the subject yourself (📖71).
- When the camera detects movement, frames will follow moving subjects, within a certain range.
- Press the shutter button halfway down. The frame will turn green when focused.
- If no face is found, after you press the shutter button halfway, a green frame is displayed around the area in focus.



- Examples of faces that cannot be detected:
 - Subjects that are distant or extremely close
 - Subjects that are dark or light
 - Faces in profile, at an angle, or partly hidden
- The camera may misinterpret non-human subjects as faces.
- An orange AF frame is displayed with (🚫) if the camera cannot focus when you press the shutter button halfway.
- Gray frames are displayed over faces detected at the edge of the screen. These cannot be focused upon by pressing the shutter button halfway.



- The maximum number of frames displayed depends on the chosen aspect ratio (📖45).
 - [3:2] [4:3] [16:9]: 49 frames
 - [1:1]: 35 frames

Before Use

Basic Guide

Advanced Guide

1 Camera Basics

2 Auto Mode / Hybrid Auto Mode

3 Other Shooting Modes

4 P Mode

5 Tv, Av, M, and C Modes

6 Playback Mode

7 Wi-Fi Functions

8 Set-Up Menu

9 Accessories

10 Appendix

Index



Choosing Subjects to Focus On (Touch AF)

► Still Images ► Movies

You can shoot after the camera focuses on your selected subject, person's face, or location shown on the screen.



1 Choose a subject, a person's face, or a location to focus on.

- Touch the subject or person on the screen.
- When the AF frame mode is set to [AF □], an AF frame is displayed where you touched.
- When the AF frame mode is set to [AF ☺], [☺] will be displayed once the subject is recognized (autofocus will continue even if the subject moves). To cancel Touch AF, touch [☺].

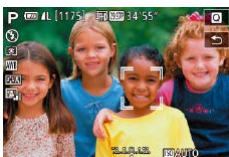

2 Shoot.

- Press the shutter button halfway. After the camera focuses, a green [□] will be displayed.
- Press the shutter button all the way down to shoot.



- If you prefer the camera not to shoot when you touch the screen, make sure [Touch Shutter] mode is deactivated. Go to the menu (M/32), set [Touch Shutter] on the [1] tab, and then choose [Disable].
- Tracking may not be possible when subjects are too small or move too rapidly, or when there is inadequate contrast between subjects and the background.



- You can press the [AF □] button to select people's faces or move the AF frame.
 - When the AF frame mode is set to [AF □], after pressing the [AF □] button, press the [▲][▼][◀][▶] buttons to move the frame, and then press the [OK] button to return to the shooting screen. Hold down the [AF □] button for at least two seconds to reset the frame to the center of the shooting or frame-adjustment screen.
 - When the AF frame mode is set to [AF ☺], after pressing the [AF □] button, [Face Select: On] will be displayed and [☺] will be shown over the face determined to be the main subject. To switch the face frame [☺] to another detected face, keep pressing the [AF □] button. Once you go through all available faces, [Face Select: Off] will be displayed and the frame will disappear.

Shooting with the AF Lock

► Still Images ► Movies

The focus can be locked. After you lock the focus, the focal position will not change even when you release your finger from the shutter button.

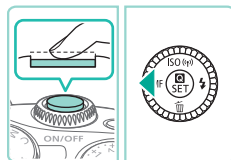

1 Lock the focus.

- With the shutter button pressed halfway, press the [L] button.
- The focus is now locked, and [MF] is displayed.
- To unlock the focus, release the shutter button and press the [L] button again. In this case, [MF] is no longer displayed.

2 Compose the shot and shoot.

Before Use

Basic Guide

Advanced Guide

1 Camera Basics

2 Auto Mode / Hybrid Auto Mode

3 Other Shooting Modes

4 P Mode

5 Tv, Av, M, and C Modes

6 Playback Mode

7 Wi-Fi Functions

8 Set-Up Menu

9 Accessories

10 Appendix

Index



Shooting with Servo AF

▶ Still Images ▶ Movies

This mode helps avoid missing shots of subjects in motion, because the camera continues to focus on the subject and adjust the exposure as long as you press the shutter button halfway.



1 Configure the setting.

- Press the button, choose [ONE SHOT], and then choose [SERVO] on the menu (32).



2 Focus.

- Press the shutter button halfway to focus. A green AF frame will be displayed.
- Once the picture composition changes or the subject moves, the AF frame turns blue and adjusts the focus. When focus is achieved, the AF frame will go back to green.



- The camera may not be able to shoot a picture while focusing, even if you press the shutter button all the way down. Continue to hold down the shutter button while following your subject.
- If focus is not achieved, the AF frame will turn orange.
- AF lock shooting is not available.
- If you set the self-timer (40) to anything besides (OFF), it is set to [ONE SHOT].



- Once set to [SERVO AF], the camera focuses on the frame in the center of the screen if it cannot detect a face when the shutter button is pressed halfway down, even if +Tracking] is activated (70).
- When servo AF is on, the exposure is not locked when you press the shutter button halfway and is not determined until the moment you shoot the picture, regardless of your current metering mode (62) settings.
- If you attach a lens with “STM” in the name, turn on servo AF for continual shooting (42) with constant focus adjustment. Using this feature will reduce the continual shooting speed. If you operate the zoom during continuous shooting, the focus may be lost.
- With other lenses, the focus will be locked for the second and subsequent frames during continuous shooting, resulting in slower continuous shooting.
- Depending on the lens used, the distance to the subject and the subject's speed, the camera may not be able to achieve correct focus.
- This can also be adjusted by going to the menu (32) and choosing [AF operation] on the 2 tab.

Before Use

Basic Guide

Advanced Guide

1 Camera Basics

2 Auto Mode / Hybrid Auto Mode

3 Other Shooting Modes

4 P Mode

5 Tv, Av, M, and C Modes

6 Playback Mode

7 Wi-Fi Functions

8 Set-Up Menu

9 Accessories

10 Appendix

Index



Changing the Focus Setting

▶ Still Images ▶ Movies

You can change default camera operation of constantly focusing on subjects it is aimed at, even when the shutter button is not pressed. Instead, you can limit camera focusing to the moment you press the shutter button halfway.

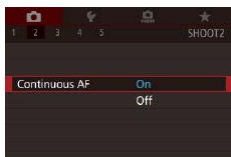

- Press the [MENU] button, choose [Continuous AF] on the [CAMERA] tab, and then choose [On] (p.32).

On	Helps avoid missing sudden photo opportunities, because the camera constantly focuses on subjects until you press the shutter button halfway.
Off	Conserves battery power, because the camera does not focus constantly. However, it may take longer than usual to focus on the subject.

Fine-tuning Focus

▶ Still Images ▶ Movies

If an EF-M lens is attached, you can use the lens's focus ring to fine-tune the focus after autofocus is complete.

1 Configure the settings.

- Press the [MENU] button, choose [AF+MF] on the [CAMERA] tab, and then choose [On] (p.32).

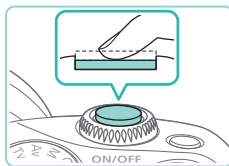

2 Focus.

- Press the shutter button halfway to autofocus and keep it halfway pressed.

3 Fine-tune the focus.

- Turn the lens focus ring to adjust the focus.
- [MF] will flash in the display.
- Remove your finger from the shutter button to cancel.

4 Shoot.

- Press the shutter button all the way down to shoot.



- This cannot be used with servo AF (p.72).
- This feature is not available when a non-EF-M lens is attached.

Before Use

Basic Guide

Advanced Guide

1 Camera Basics

2 Auto Mode / Hybrid Auto Mode

3 Other Shooting Modes

4 P Mode

5 Tv, Av, M, and C Modes

6 Playback Mode

7 Wi-Fi Functions

8 Set-Up Menu

9 Accessories

10 Appendix

Index



Shooting in Manual Focus Mode

▶ Still Images ▶ Movies

When focusing is not possible in AF mode, use manual focus. Magnifying the screen display will make it easier to focus.

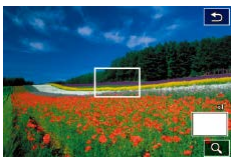
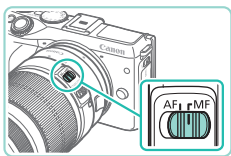

1 Choose [MF].

- Press the [◀] button if you have an EF-M lens attached.
- If you have a non-EF-M lens, turn off the camera, set the lens switch to [MF], and then turn the camera back on.
- [MF] is displayed.

2 Display the magnifying frame.

- Press the [M-F] button.
- The magnifying frame will appear in the center of the screen. On the bottom right, you will see a magnification ratio and the area currently being magnified.

3 Select the area to magnify.

- Press the [▲][▼][◀][▶] buttons to move the frame and select the area to magnify.
- Hold down the [M-F] button for at least two seconds to reset the frame to the center of the screen.

4 Use the magnified display.

- Press the [M-F] button or turn the [ZOOM] dials to switch the overall magnification between 1x (no magnification), 5x, or 10x.

5 Focus.

- While looking at the magnified display, turn the lens focusing ring to focus.

6 Shoot.



- If [Continuous AF] is set to [Off], you do not need to turn off the camera when switching to [MF] when using a non-EF-M lens.



- You can drag the frame in step 3 to move the magnified display.
- You can also touch the [Q] on the bottom right to change the magnification level or drag the screen to change the magnified display position.

Easily Identifying the Focus Area (MF Peaking)

▶ Still Images ▶ Movies

Edges of subjects in focus are displayed in color to make manual focusing easier. You can adjust the colors and the sensitivity (level) of edge detection as needed.

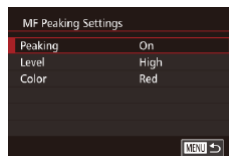

1 Access the setting screen.

- Press the [MENU] button, choose [MF Peaking Settings] on the [Q2] tab, and then set [Peaking] to [On] (p.32).

2 Configure the setting.

- Choose a menu item to configure, and then choose the desired option (p.32).



- Colors displayed for MF peaking are not recorded in your shots.

Before Use

Basic Guide

Advanced Guide

1 Camera Basics

2 Auto Mode / Hybrid Auto Mode

3 Other Shooting Modes

4 P Mode

5 Tv, Av, M, and C Modes

6 Playback Mode

7 Wi-Fi Functions

8 Set-Up Menu

9 Accessories

10 Appendix

Index



Flash

Changing the Flash Mode

▶ Still Images ▶ Movies

You can change the flash mode to match the shooting scene. For details on the flash range, see “Internal Flash Range Guide” (196).

1 Raise the flash.

- Move the [Flash] switch.

2 Configure the setting.

- Press the [Right] button, press the [Left/Right] buttons or turn the [Dial] to choose a flash mode, and then press the [OK] button.
- The option you configured is now displayed.

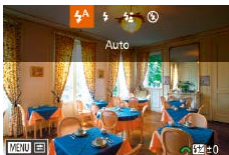

- The setting screen cannot be accessed by pressing the [Right] button when the flash is lowered. Move the [Flash] switch to raise the flash and then configure the setting.
- If the flash fires, vignetting may occur. If the flash fires, vignetting may occur depending on the lens being used.



- When there is a risk of overexposure, the camera automatically adjusts the shutter speed or ISO speed during the flash shots to reduce washed-out highlights and shoot at optimal exposure. For this reason, when shooting with the flash, the shutter speed or ISO speed displayed when you pressed the shutter button halfway, may not match the actual shoot setting.
- This can also be configured by going to the menu (32), choosing the [Camera] tab, and selecting [Flash firing] in the [Flash Control] option.

Auto

Fires automatically in low-light conditions.

On

Fires for each shot.

Slow Synchro

Fires to illuminate the main subject (such as people) while shooting at a slower shutter speed to illuminate backgrounds out of flash range.



- In [Auto] mode, mount the camera on a tripod or take other measures to keep it still and prevent camera shake. Additionally, you should turn off image stabilization when using a tripod or other means to secure the camera (78).
- In [Slow Synchro] mode, even after the flash fires, ensure that the main subject does not move until the shutter sound is finished playing.

Off

For shooting without the flash.

Before Use

Basic Guide

Advanced Guide

1 Camera Basics

2 Auto Mode / Hybrid Auto Mode

3 Other Shooting Modes

4 P Mode

5 Tv, Av, M, and C Modes

6 Playback Mode

7 Wi-Fi Functions

8 Set-Up Menu

9 Accessories

10 Appendix

Index



Adjusting the Flash Exposure Compensation

▶ Still Images ▶ Movies

Just as with regular exposure compensation (📖61), you can adjust the flash exposure from -2 to +2 stops, in 1/3-stop increments.

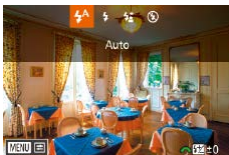

- Raise the flash, press the [▶] button and immediately turn the [☀️] dial to choose the compensation level, and then press the [📷] button.
- The correction level you specified is now displayed.



- You can configure the flash exposure compensation by accessing MENU (📖32) and choosing [📷] tab > [Flash Control] > [Built-in flash settings] > [exp. comp.].
- You can also access the [Flash Control] screen (📖32) as follows.
 - Press and hold the [▶] button for at least one second.
 - When the flash is up, press the [▶] button and immediately press the [MENU] button.



- You can also access the [Flash Control] screen (📖32) by pressing the [▶] button and touching [MENU].

Shooting with the FE Lock

▶ Still Images ▶ Movies

Just as with the AE lock (📖61), you can lock the exposure for flash shots.

1 Raise the flash and set it to [📷] (📖75).

2 Lock the flash exposure.

- Aim the camera at the subject to shoot with the exposure locked, and then press the [✖] button.
- The flash fires, and when [📷] is displayed, the flash output level is retained.
- Press the [✖] button again to cancel and remove the [📷] icon.

3 Compose the shot and shoot.



- FE: Flash Exposure
- While in FE lock, a circle in the center of the screen shows the current metering range.
- If standard exposure is not achieved even after the flash fires in step 2, [📷] flashes. Follow step 2 while the subject is within flash range.

Before Use

Basic Guide

Advanced Guide

1 Camera Basics

2 Auto Mode / Hybrid Auto Mode

3 Other Shooting Modes

4 P Mode

5 Tv, Av, M, and C Modes

6 Playback Mode

7 Wi-Fi Functions

8 Set-Up Menu

9 Accessories

10 Appendix

Index



Changing the Flash Timing

▶ Still Images ▶ Movies

Change the timing of the flash and shutter release as follows.

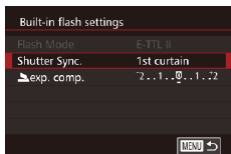

- Press the [MENU] button, choose [Flash Control] on the [CAMERA] tab, and select [Built-in flash settings].
- Choose [Shutter Sync.], and then choose the desired option (see 32).

1st curtain	The flash fires immediately after the shutter opens.
2nd curtain	The flash fires immediately before the shutter closes.



- If the shutter speed is set to 1/100 or faster, the flash fires on [1st curtain], even if [2nd curtain] is selected.

Changing the Flash Metering Mode

▶ Still Images ▶ Movies

When shooting with the flash, [Evaluative] is used for a standard flash exposure. This metering method can be changed to average flash metering mode across the overall flash region, such as when using an externally metered flash.

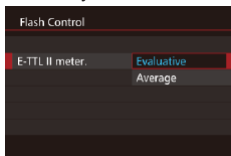

- Press the [MENU] button, choose [Flash Control] on the [CAMERA] tab, select [E-TTL II meter.], and then select [Average].



- When using [Average], adjust your flash metering compensation for the scene to be shot.

Resetting Flash Settings

▶ Still Images ▶ Movies

You can reset the [Built-in flash settings] to their defaults.

- Press the [MENU] button, choose [Flash Control] on the [CAMERA] tab, and select [Clear settings].
- Choose [Clear built-in flash set.] and press the [OK] button. On the next screen, press the [LEFT] [RIGHT] buttons or turn the [DIAL] dial to choose [OK], and then press the [OK] button.

Before Use

Basic Guide

Advanced Guide

1 Camera Basics

2 Auto Mode / Hybrid Auto Mode

3 Other Shooting Modes

4 P Mode

5 Tv, Av, M, and C Modes

6 Playback Mode

7 Wi-Fi Functions

8 Set-Up Menu

9 Accessories

10 Appendix

Index



Other Settings

Changing the IS Mode Settings

▶ Still Images ▶ Movies

If you have an EF-M lens with an image stabilization function, image stabilization can be adjusted in the menu.

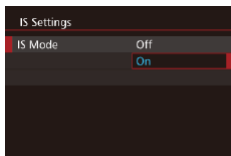

1 Access the setting screen.

- Press the [MENU] button, choose [IS Settings] on the [Q2] tab, and then press the [INFO] button (32).

2 Configure the setting.

- Choose [IS Mode], and then choose the desired option (32).

On	If using a lens with built-in image stabilization, the camera compensates for camera movement and hand shaking to stabilize the image when shooting.
Off	Deactivates image stabilization.



- If image stabilization cannot prevent camera shake, mount the camera on a tripod or take other measures to hold it still. In this case, set [IS Mode] to [Off].
- [IS Mode] is not displayed when a non-EF-M lens is attached. Use the image stabilization switch on the lens instead (22).
- Do not use image stabilization for bulb exposures. Doing so may lead to incorrect image stabilization behavior.



- Lenses with built-in image stabilization have “IS” in their names. IS stands for Image Stabilizer.

Shooting Movies with Subjects at the Same Size Shown before Shooting

▶ Still Images ▶ Movies

Normally, once movie recording begins, the image display area changes and subjects are enlarged to allow for correction of significant camera shake. To shoot subjects at the same size shown before shooting, you can choose not to reduce significant camera shake.

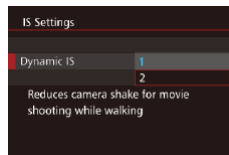

- Follow the steps in “Changing the IS Mode Settings” (78) to access the [IS Settings] screen.
- Choose [Dynamic IS], and then choose [2] (32).



- [Dynamic IS] is displayed only when using a lens that supports dynamic image stabilization.



- You can also set [IS Mode] to [Off], so that subjects are recorded at the same size shown before shooting.

Before Use

Basic Guide

Advanced Guide

1 Camera Basics

2 Auto Mode / Hybrid Auto Mode

3 Other Shooting Modes

4 P Mode

5 Tv, Av, M, and C Modes

6 Playback Mode

7 Wi-Fi Functions

8 Set-Up Menu

9 Accessories

10 Appendix

Index



Lens Peripheral Illumination/Chromatic Aberration Correction

▶ Still Images ▶ Movies

The unique properties of a lens may cause vignetting or color bleeding around the contours of the subject. These phenomena can be corrected. The camera comes with around 35 lenses worth of peripheral illumination/chromatic aberration correction data. Use the EOS Utility software to view the lens settings available; if your camera has no data for your lens, you can add it to the camera. For details, refer to the EOS Utility instruction manual (📖 158).

* There is no need to add data for EF-M lenses.

1 Select [Lens aberration correction].

- Press the [MENU] button and choose [Lens aberration correction] on the [CAMERA] tab, and choose the option (📖 32).

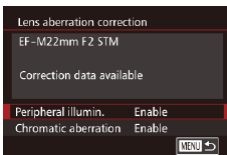

2 Check if correction data is available.

- Confirm that [Correction data available] is displayed for the attached lens.

3 Select the desired setting.

- Select the desired option and press the [SET] button to set (📖 31).



- Peripheral illumination correction and chromatic aberration correction cannot be applied to JPEG images already taken.
- When using a non-Canon lens, setting the corrections to [Disable] is recommended, even if [Correction data available] is displayed.
- RAW images can be corrected with the Digital Photo Professional software (📖 158).
- Setting [Peripheral illumin.] to [Enable] may cause noise in the image periphery, depending on shooting conditions.
- The effects of chromatic aberration correction cannot be viewed on RAW images with the camera. Use the Digital Photo Professional software (📖 158) to view the correction instead.



- Your settings will be retained even after changing lenses, but no correction will take place if no correction data has been added for the new lens. If [Correction data not available] is displayed in step 2, use the EOS Utility software (📖 158) to add lens correction data to the camera.
- If the effect of the correction is not visible, magnify the image and check it again.
- The corrections are also applied when an Extender or Life-size Converter is attached.
- If the lens does not have distance information, the correction amount will be lower.
- The correction amount applied with [Peripheral illumin.] will be slightly lower than the maximum correction amount that can be set with the Digital Photo Professional software.
- The higher the ISO speed, the lower the peripheral illumination correction value will be.

Before Use

Basic Guide

Advanced Guide

1 Camera Basics

2 Auto Mode / Hybrid Auto Mode

3 Other Shooting Modes

4 P Mode

5 Tv, Av, M, and C Modes

6 Playback Mode

7 Wi-Fi Functions

8 Set-Up Menu

9 Accessories

10 Appendix

Index



Changing the Noise Reduction Level

▶ Still Images ▶ Movies

You can choose from 3 levels of noise reduction: [Standard], [High], [Low]. This is particularly effective when shooting at high ISO speeds.

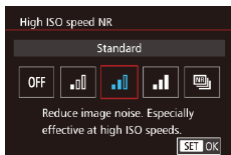

- Press the [MENU] button, choose [High ISO speed NR] on the [4] tab, and then choose the desired option (32).

Using Multi Shot Noise Reduction

The camera can automatically shoot four pictures in a single shot and combine the images to provide high-quality noise reduction, better than the [High] selection for [High ISO speed NR].

1 Choose [4].

- Follow the steps in “Changing Noise Reduction Level” to select [4].

2 Shoot.

- Press the shutter button all the way down. The camera will take four pictures and combine them, so keep your hands steady while shooting.



- Unexpected results may occur if there is significant misalignment in the image due to camera shake. Securing the camera with a tripod or other means is recommended.
- If you shoot a moving subject, the subject's movement may leave afterimages or the surrounding area of the subject may become dark.
- Depending on shooting conditions, noise may appear on the image periphery.
- This cannot be used with AEB, [Long exp. noise reduction], during RAW image shooting, or bulb shooting. If any of these is already in use, [Multi Shot Noise Reduction] will not be available.
- Flash shooting is not possible.
- Recording the image to the card will take longer than with normal shooting. You cannot take another picture until processing is completed.

Before Use

Basic Guide

Advanced Guide

1 Camera Basics

2 Auto Mode / Hybrid Auto Mode

3 Other Shooting Modes

4 P Mode

5 Tv, Av, M, and C Modes

6 Playback Mode

7 Wi-Fi Functions

8 Set-Up Menu

9 Accessories

10 Appendix

Index



Reducing Noise at Slow Shutter Speeds

▶ Still Images ▶ Movies

The camera can reduce the noise that occurs during long exposures at shutter speeds of 1 second or slower.

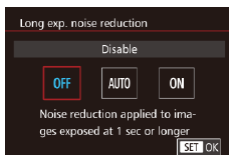

- Press the [MENU] button, choose [Long exp. noise reduction] on the [4] tab, and then choose the desired option (p.32).

OFF (Disable)	Do not perform noise reduction during long exposures.
AUTO (Auto)	Perform noise reduction when noise is detected that is specific to long exposures at shutter speeds of 1 second or slower.
ON (Enable)	Always perform noise reduction at shutter speeds of 1 second or slower.



- There may be a delay before you can shoot again, as the camera processes images to reduce noise.
- Shooting pictures at a speed of ISO1600 or higher with this option set to [ON] may result in grainier images than setting the option to [OFF] or [AUTO].

Before Use

Basic Guide

Advanced Guide

1 Camera Basics

2 Auto Mode / Hybrid Auto Mode

3 Other Shooting Modes

4 P Mode

5 Tv, Av, M, and C Modes

6 Playback Mode

7 Wi-Fi Functions

8 Set-Up Menu

9 Accessories

10 Appendix

Index



5

Tv, Av, M, and C Modes

Take smarter, more sophisticated shots, and customize the camera for your shooting style

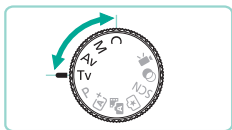

- Instructions in this chapter apply to the camera as set to the respective mode.

Specific Shutter Speeds ([Tv] Mode)

▶ Still Images ▶ Movies

Set your preferred shutter speed before shooting as follows. The camera automatically adjusts the aperture value to suit your shutter speed. For details on available shutter speeds, see “Shutter” (📖192).



1 Enter [Tv] mode.

- Set the mode dial to [Tv].

2 Set the shutter speed.

- Turn the [🌞] dial to set the shutter speed.



- If [Long exp. noise reduction] is set to [ON] or [AUTO] and shooting is performed with a shutter speed of 1 second or slower, there may be a delay before taking the next picture due to post-shot noise reduction processing.
- When shooting at slow shutter speeds on a tripod, you should turn off image stabilization (📖78).
- Maximum shutter speed with the flash is 1/200 second. If you specify a faster speed, the camera will automatically reset the speed to 1/200 second before shooting.
- Orange display of aperture values when you press the shutter button halfway indicates that the settings deviate from standard exposure. Adjust the shutter speed until the aperture value is displayed in white, or use safety shift (📖88).



- [Tv]: Time value

Before Use

Basic Guide

Advanced Guide

1 Camera Basics

2 Auto Mode / Hybrid Auto Mode

3 Other Shooting Modes

4 P Mode

5 Tv, Av, M, and C Modes

6 Playback Mode

7 Wi-Fi Functions

8 Set-Up Menu

9 Accessories

10 Appendix

Index



Specific Aperture Values ([Av] Mode)

▶ Still Images ▶ Movies

Set your preferred aperture value before shooting as follows. The camera automatically adjusts the shutter speed to suit your aperture value. Aperture values allowed differ depending on the lens.



1 Enter [Av] mode.

- Set the mode dial to **[Av]**.

2 Set the aperture value.

- Turn the  dial to set the aperture value.



- Orange display of shutter speeds when you press the shutter button halfway indicates that the settings deviate from standard exposure. Adjust the aperture value until the shutter speed is displayed in white, or use safety shift (88).
- Maximum shutter speed with the flash is 1/200 sec. When shooting with the flash, the camera may automatically change the defined aperture value to ensure the shutter speed is not faster than 1/200 sec.



- **[Av]**: Aperture value (size of the opening made by the diaphragm in the lens)

Depth-of-Field Preview

The aperture is open when not shooting with the camera. Its size changes only at the instant a picture is taken. As a result, the depth of field may look narrower (shallower) when viewed in the monitor. Add  (Depth-of-field preview) to the buttons (89) and press the assigned button to preview the depth of field.

Before Use

Basic Guide

Advanced Guide

1 Camera Basics

2 Auto Mode / Hybrid Auto Mode

3 Other Shooting Modes

4 P Mode

5 Tv, Av, M, and C Modes

6 Playback Mode

7 Wi-Fi Functions

8 Set-Up Menu

9 Accessories

10 Appendix

Index



Specific Shutter Speeds and Aperture Values ([M] Mode)

▶ Still Images ▶ Movies

Follow these steps before shooting to set your preferred shutter speed and aperture value to obtain the desired exposure. For details on available shutter speeds, see “Shutter” (192). Aperture values allowed will differ depending on the lens.

1 Enter [M] mode.

- Set the mode dial to [M].

2 Configure the setting.

- Turn the [S] dial to set the shutter speed (1).
- Press the [▲] button to choose aperture value (2) or ISO speed (3), and turn the [D] dial to specify a value.
- If the ISO speed is locked, an exposure level mark (5) based on your specified value is shown on the exposure level indicator for comparison to the standard exposure level (4). If deviation from the standard exposure level exceeds two stops, the exposure level indicator turns into a [◀] or [▶].
- If ISO speed is set to [AUTO], pressing the shutter button halfway will lock the ISO speed and change the screen brightness. If standard exposure cannot be obtained with the defined shutter speed and aperture value, the ISO speed is displayed in orange.



- After you set the shutter speed and aperture value, the exposure level may change if you adjust the zoom or recompose the shot.
- When the ISO speed is locked, screen brightness may change depending on your specified shutter speed or aperture value. However, screen brightness remains the same when the flash is up and the mode is set to [M].
- If ISO speed is set to [AUTO], the ISO speed setting changes to suit the shutter speed and aperture in order to obtain a standard exposure. As a result, you may not obtain the desired exposure effect.
- The Auto Lighting Optimizer (64) may change the image brightness. Press the [INFO] button in the Auto Lighting Optimizer settings screen and add a [✓] to the [Disable during man expo] option to keep the Auto Lighting Optimizer in [M] mode fixed to [Disable].



- [M]: Manual
- Calculation of standard exposure is based on the specified metering method (62).
- You can customize camera operation so that turning the [D] dial adjusts the shutter speed and turning the [S] dial adjusts the aperture value (89).
- The following actions are available when the ISO speed is set to [AUTO].
 - Use the exposure compensation dial to adjust the exposure.
 - Press the [★] button to lock the ISO speed and adjust the screen brightness.

Before Use

Basic Guide

Advanced Guide

1 Camera Basics

2 Auto Mode / Hybrid Auto Mode

3 Other Shooting Modes

4 P Mode

5 Tv, Av, M, and C Modes

6 Playback Mode

7 Wi-Fi Functions

8 Set-Up Menu

9 Accessories

10 Appendix

Index



Long (Bulb) Exposures

A bulb exposure keeps the shutter open for as long as you hold down the shutter button.

1 Activate bulb shooting.

- Follow steps 1 – 2 in “Specific Shutter Speeds and Aperture Values ([M] Mode)” (84) and set the shutter speed to [BULB].

2 Shoot.

- The exposure lasts as long as the shutter button is pressed. The elapsed exposure time will be displayed on the LCD monitor during exposure.



- Mount the camera on a tripod or take other measures to keep it still and prevent camera shake. Additionally, you should turn off image stabilization when using a tripod or other means to secure the camera (78).
- Since bulb exposures produce more noise than usual, the image may look grainy. There is a way to reduce noise in long exposures when [Long exp. noise reduction] is set to [AUTO] or [ON] (80).



- You can also use a Remote Controller (sold separately) for bulb exposures (152).



- If the [Touch Shutter] is set to [Enable], touching the screen will begin the exposure. Touch the screen again to end the exposure. Be careful not to shake the camera when tapping the screen.

Adjusting the Flash Output

▶ Still Images ▶ Movies

Choose from the three flash levels in [Tv], [Av] and [M] modes.

1 Set the flash mode to [Manual flash].

- Press the [MENU] button and select [Flash Control] on the [3] tab. Choose [Built-in flash settings] and set the [Flash Mode] to [Manual flash] (32).

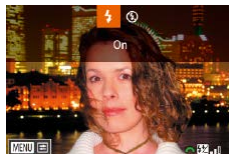

2 Configure the settings.

- Raise the flash, press the [▶] button and immediately turn the [Flash Level] dial to choose the flash level, and then press the [OK] button.
- Once the setting is complete, the flash output level is displayed.
[1/2]: Minimum, [1/2.]: Medium, [1/2.]: Maximum



- Flash levels can also be configured by going to the menu (32), choosing the [3] tab, selecting [Built-in flash settings] in the [Flash Control] option, and choosing [▶] flash output].
- You can also access the [Flash Control] screen (32) as follows.
 - Press and hold the [▶] button for at least one second.
 - When the flash is up, press the [▶] button and immediately press the [MENU] button.



- You can also access the [Flash Control] screen (32) by pressing the [▶] button and touching [MENU].

Before Use

Basic Guide

Advanced Guide

1 Camera Basics

2 Auto Mode / Hybrid Auto Mode

3 Other Shooting Modes

4 P Mode

5 Tv, Av, M, and C Modes

6 Playback Mode

7 Wi-Fi Functions

8 Set-Up Menu

9 Accessories

10 Appendix

Index



Specific Shutter Speeds and Aperture Values

▶ Still Images ▶ Movies

Follow these steps to set your preferred shutter speed, aperture value and ISO speed. For details on available shutter speeds, see “Shutter” (192). Aperture values allowed differ depending on the lens.

1 Enter [P] mode.

- Set the mode dial to [P].
- Press the [MENU] button, choose [P] in the menu, and then choose [P] (31).



2 Configure the settings.

- Turn the [S] dial to set the shutter speed.
- To set the aperture value and ISO speed, press [▲], choose the desired option, and then turn the [D] dial to adjust the setting.



- You may see image flicker while shooting under fluorescent or LED lighting, depending on the shutter speed.
- With a large aperture value, it may take longer to achieve focus, or correct focus may not be achieved.



- If the ISO speed is locked, an exposure level mark based on your specified value is shown on the exposure level indicator for comparison to the standard exposure level. If deviation from the standard exposure level exceeds two stops, the exposure level indicator turns into a [◀] or [▶].
- If the ISO speed is set to [AUTO], you can press the shutter button halfway to view the current ISO speed. If standard exposure cannot be obtained with the defined shutter speed and aperture value, the exposure level mark moves to show the deviation. The exposure level mark turns into a [◀] or [▶] when deviation from the standard exposure level exceeds two stops.
- The ISO speed allowed will differ depending on the image quality. ISO 100 – ISO 3200 with [FHD 29.97P], [FHD 23.98P] or [FHD 25.00P], ISO 100 – ISO 6400 with [HD 59.94P], [HD 50.00P], [VGA 29.97P] or [VGA 25.00P].



- Touch an option on the bottom of the screen and then touch [◀][▶] to adjust its settings.
- Touch [AF] to lock the focus position. [MF] will be shown on the screen.

Before Use

Basic Guide

Advanced Guide

1 Camera Basics

2 Auto Mode / Hybrid Auto Mode

3 Other Shooting Modes

4 P Mode

5 Tv, Av, M, and C Modes

6 Playback Mode

7 Wi-Fi Functions

8 Set-Up Menu

9 Accessories

10 Appendix

Index



Customizing Controls and Display

Customizing Display Information

You can define which screens are shown when the [INFO] button is pressed in the shooting screen. You can also customize the data displayed by the screens.

1 Access the setting screen.

- Choose the [CAMERA] tab, select [Shooting information display], and then choose [Display switching] and press the [INFO] button (p.31).

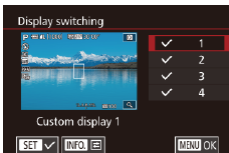

2 Configure the settings.

- Press the [▲][▼] buttons or turn the [DIAL] dial to choose the screens you do not want displayed and then press the [INFO] button to remove the [✓]. Press the [INFO] button again to add a [✓].
- To return to the menu screen, press the [MENU] button.



- Use the display sample on the left side of the screen to see what your selected effect in step 2 will look like.
- You cannot remove all [✓] or add a [✓] only to [INFO. Quick Control].

Customizing Displayed Data

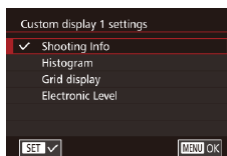

- Follow steps 1 – 2 in “Customizing Display Information” (p.87) to select [Custom display 1] or [Custom display 2] and then press the [INFO] button.
- Press the [▲][▼] buttons or turn the [DIAL] dial to choose the information to display and then press the [INFO] button to add a [✓].
- Press the [MENU] button to return to the [Display switching] screen and check the resulting display.



- Go to [Shooting information display] on the [CAMERA] tab and choose [Grid display] to change to a finer grid.
- Go to [Shooting information display] on the [CAMERA] tab and choose [Histogram] to change the displayed histogram from a brightness histogram to an RGB histogram.

Before Use

Basic Guide

Advanced Guide

1 Camera Basics

2 Auto Mode / Hybrid Auto Mode

3 Other Shooting Modes

4 P Mode

5 Tv, Av, M, and C Modes

6 Playback Mode

7 Wi-Fi Functions

8 Set-Up Menu

9 Accessories

10 Appendix

Index



Setting Up Advanced Camera Functions

The [1] tab of the menu (32) lets you customize various camera functions to suit your picture-taking preferences. Frequently used functions can also be added to the front dial, control dial, and buttons.

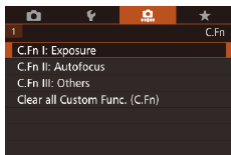

1 Select a function type.

- Press the [MENU] button and choose the [1] tab (32).
- Press the [][] buttons or turn the dial to choose the function type (Exposure, AF, Other), and then press the button.

2 Select the desired function.

- If you selected Exposure or Others, press the [][] buttons or turn the [][] dials to select a function and then press the button.

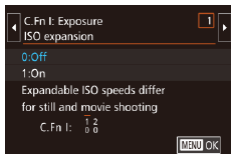

3 Choose an option.

- Press the [][] buttons or turn the dial to choose an option.
- Press the button to return to the menu screen.

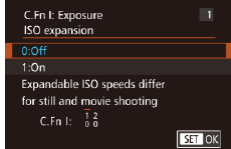

Function type	Function	Description
Exposure	ISO expansion	When set to [1:On], ISO speed [H] is available for selection. In ISO 25600-equivalent (P/Av) mode, [H] is equivalent to ISO 6400 (), (), or () or ISO 12800 (, ,) or ().
	Safety shift	When set to [1:On], if standard exposure cannot be obtained with the defined shutter speed and aperture value in [Tv] or [Av] mode, the camera automatically changes the shutter speed and aperture value in order to get closer to the standard exposure.
Autofocus	AF-assist beam (LED) firing	When set to [1:Disable], the AF-assist beam will not fire.
Others	Custom Controls	Add frequently used functions to the front dial, control dial, and buttons (89).
	Release shutter w/o lens	When set to [1:Enable], you can press the shutter button all the way or press the movie button to record images, even if there is no lens attached to the camera.
	Retract lens on power off	Define whether to automatically retract the lens when the camera is turned off.

Before Use

Basic Guide

Advanced Guide

1 Camera Basics

2 Auto Mode / Hybrid Auto Mode

3 Other Shooting Modes

4 P Mode

5 Tv, Av, M, and C Modes

6 Playback Mode

7 Wi-Fi Functions

8 Set-Up Menu

9 Accessories

10 Appendix

Index





- Choose [Clear All Custom Func. (C.Fn)] in step 1 and press the button to remove all the changed functions on the tab and restore it to default.
- Even with [ISO expansion] set to [1:On], [H] cannot be selected if [Highlight tone priority] is set to [D+] (64).
- Safety shift is disabled when the flash fires.
- The AF-assist beam is light from the lamp (front) that turns on when the shutter button is pressed halfway in dark areas to help with focusing.
- [Retract lens on power off] is supported by the following lens.
 - EF 40mm f/2.8 STM
 - EF-S 24mm f/2.8 STM

Adding Functions to Buttons and Dials

You can change the function of the shutter / button or / dial, as well as add frequently used functions to the [M-Fn], (), and movie buttons.

1 Access the function assignment screen.

- Follow steps 1 – 2 in “Setting Up Advanced Camera Functions” (88) and choose [Custom Controls] from [Other].

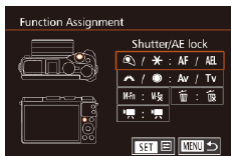

2 Assign functions to controls.

- Press the () buttons or turn the / dials to select the dial or button to assign a function to, and then press the button.
- If changing the function of the shutter / button or / dial, press the () buttons or turn the dial to select the function.

- If adding a function to the [M-Fn] button, (), or movie button, press the () buttons or turn the / dials to select the function.
- Press the button to return to the previous menu screen.

Shutter button / button	Set to [AE/AF, no AE lock], and you can press the button to focus. In this case, AE lock is not applied when the button is pressed. Using the touch shutter, the camera takes a picture without focusing.
/ dials	Set to [Av/TV], and you can use the dial to adjust the aperture value and the dial to adjust the shutter speed in [M] mode.
[M-Fn] button	Pressing the button will trigger the assigned action.
() button)	
Movie button	

Before Use

Basic Guide

Advanced Guide

1 Camera Basics

2 Auto Mode / Hybrid Auto Mode

3 Other Shooting Modes

4 P Mode

5 Tv, Av, M, and C Modes

6 Playback Mode

7 Wi-Fi Functions

8 Set-Up Menu













9 Accessories

10 Appendix

Index







- To restore the [M-Fn] button, [▼]() button, and movie button to their defaults, choose [MFn], [] and [] respectively.
- If you don't want to add functions to the [M-Fn] button, [▼]() button, and movie button, choose [MFn], [] and [] respectively.
- Icons labeled with (⊘) in the [M-Fn] button, [▼]() button and movie button assignment screen indicate that the function is not available in the current shooting mode or under current function conditions.
- Assign [] to a button, and every time the button is pressed, the camera will switch between saving or not saving simultaneous RAW images.
- Assign [] to a button, and the camera will use the defined aperture value while the button is pressed, letting you preview the depth of field.
- Assign [] to a button, and the screen display will disappear when the button is pressed. Perform one of the following actions to restore the display.
 - Press a button other than the power button
 - Turn the exposure compensation dial, mode dial, or [][] dials
 - Change the camera's vertical/horizontal orientation
 - Open or close the flash
 - Open the LCD monitor and rotate it upward all the way, or close the LCD monitor when rotated upward all the way

Saving Shooting Settings ([C] Mode)

▶ Still Images ▶ Movies

Save commonly used shooting modes and your configured function settings for reuse. To access saved settings later, simply turn the mode dial to [C]. Even settings that are usually cleared when you switch shooting modes or turn the camera off (such as self-timer settings) can be retained this way.

Settings that can be saved

- Shooting modes ([P], [Tv], [Av], and [M])
- Items set in [P], [Tv], [Av], and [M] modes (61 – 84)
- Shooting menu settings
- My Menu settings (91)



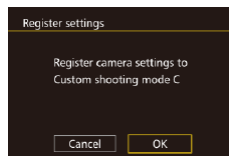
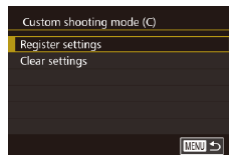

1 Enter a shooting mode with settings you want to save, and change the settings as desired.

2 Access the Register Settings screen.

- Press the [MENU] button, choose [Custom shooting mode (C)] on the [] tab, and then press the [] button.



3 Register.

- Press the [▲][▼] buttons or turn the [] dial to choose [Register settings], and then press the [] button.
- A confirmation screen will appear. Press the [◀][▶] buttons or turn the [] dial to select [OK], and then press the [] button.

Before Use

Basic Guide

Advanced Guide

1 Camera Basics

2 Auto Mode / Hybrid Auto Mode

3 Other Shooting Modes

4 P Mode

5 Tv, Av, M, and C Modes

6 Playback Mode

7 Wi-Fi Functions

8 Set-Up Menu

9 Accessories

10 Appendix

Index





- To edit saved settings (except their shooting mode), choose [C], change the settings, and then repeat steps 2 – 3. These setting details are not applied in other shooting modes.



- To reset saved settings to their defaults, choose [Clear settings] in step 2, press the [MENU] button, and then choose [OK] and press the [MENU] button.

Saving Commonly Used Shooting Menu Items (My Menu)

▶ Still Images ▶ Movies

You can save up to six commonly used shooting menu items on the [★1] tab. By customizing the [★1] tab, you can access to these items quickly from a single screen.

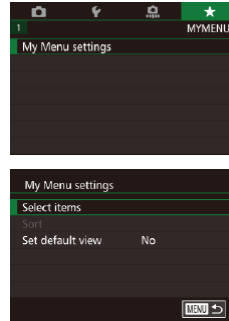

1 Access the setting screen.

- Press the [MENU] button, choose [My Menu settings] on the [★1] tab, and then press the [MENU] button (p. 32).

2 Configure the setting.

- Press the [▲][▼] buttons or turn the [DISP] dial to choose [Select items], and then press the [MENU] button.
- Press the [▲][▼] buttons or turn the [DISP] dial to choose a menu item to save (max. six items) and then press the [MENU] button to save it.
- [✓] is displayed.
- To cancel saving, press the [MENU] button. [✓] is no longer displayed.
- Press the [MENU] button.

Before Use

Basic Guide

Advanced Guide

1 Camera Basics

2 Auto Mode / Hybrid Auto Mode

3 Other Shooting Modes

4 P Mode

5 Tv, Av, M, and C Modes

6 Playback Mode

7 Wi-Fi Functions

8 Set-Up Menu

9 Accessories

10 Appendix

Index



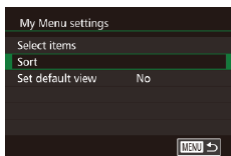

3 Rearrange menu items as needed.

- Press the [**▲**][**▼**] buttons or turn the [**DISP**] dial to choose [Sort], and then press the [**DISP**] button.
- Choose a menu item to move (either press the [**▲**][**▼**] buttons or turn the [**DISP**] dial), and then press the [**DISP**] button.
- Press the [**▲**][**▼**] buttons or turn the [**DISP**] dial to change the order, and then press the [**DISP**] button.
- Press the [**MENU**] button.



- Grayed-out items in step 2 can also be specified, but they may not be available in some shooting modes.



- To make My Menu immediately accessible by pressing the [**MENU**] button in Shooting mode, choose [Set default view] to choose [Yes].



- On the [Select items] screen for saving or clearing items, you can also touch items to select them.
- On the [Sort] screen, you can also drag items to change the display order.

Before Use

Basic Guide

Advanced Guide

1 Camera Basics

2 Auto Mode / Hybrid Auto Mode

3 Other Shooting Modes

4 P Mode

5 Tv, Av, M, and C Modes

6 Playback Mode

7 Wi-Fi Functions

8 Set-Up Menu

9 Accessories

10 Appendix

Index



6

Playback Mode

Have fun reviewing your shots, and browse or edit them in many ways

- To prepare the camera for these operations, press the [▶] button to enter Playback mode.



- It may not be possible to play back or edit images that were renamed or already edited on a computer, or images from other cameras.

Viewing

▶ Still Images ▶ Movies

After shooting images or movies, you can view them on the screen as follows.

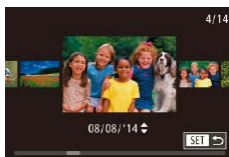

1 Enter Playback mode.

- Press the [▶] button.
- Your last shot is displayed.

2 Choose images.

- To view the previous image, press the [◀] button or turn the [⦿] dial counterclockwise. To view the next image, press the [▶] button or turn the [⦿] dial clockwise.
- Press and hold the [◀][▶] buttons to browse through images quickly.
- To access this screen (Scroll Display mode), turn the [⦿] dial rapidly. In this mode, press the [◀][▶] buttons or turn the [⦿] dial to browse through images.
- To return to single-image display, press the [⦿] button.
- To browse images grouped by shooting date, press the [▲][▼] buttons in Scroll Display mode.
- Movies are identified by a [SET ▶] icon. To play movies, go to step 3.

Before Use

Basic Guide

Advanced Guide

1 Camera Basics

2 Auto Mode / Hybrid Auto Mode

3 Other Shooting Modes

4 P Mode

5 Tv, Av, M, and C Modes

6 Playback Mode

7 Wi-Fi Functions

8 Set-Up Menu

9 Accessories

10 Appendix

Index





3 Play movies.

- To start playback, press the [Ⓜ] button, press the [▲][▼] buttons to choose [▶], and then press the [Ⓜ] button again.



(1)

4 Adjust the volume.

- Press the [▲][▼] buttons to adjust the volume.
- To adjust the volume when the volume indicator (1) is no longer displayed, press the [▲][▼] buttons.

5 Pause playback.

- To pause or resume playback, press the [Ⓜ] button.
- After the movie is finished, [SET ▶] is displayed.



- To switch to Shooting mode from Playback mode, press the shutter button halfway.
- To deactivate Scroll Display, choose MENU (32), > [▶] 3 tab > [Scroll Display] > [Off].
- To have the most recent shot displayed when you enter Playback mode, choose MENU (32), > [▶] 3 tab, > [Resume] > [Last shot].
- To change the transition shown between images, access MENU (32), and choose your desired effect on the [▶] 3 tab > [Transition Effect].

Touch-Screen Operations

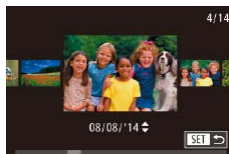

- To view the next image, drag right to left across the screen, and to view the previous image, drag left to right.
- To access Scroll Display mode, quickly drag left or right repeatedly.
- You can also choose images in Scroll Display mode by dragging left or right.
- Touching the central image will restore single-image display.
- To browse images grouped by shooting date in Scroll Display mode, drag up or down.
- To start movie playback, touch [▶] in step 3 of "Viewing" (94).
- To adjust the volume during movie playback, quickly drag up or down across the screen.

Before Use

Basic Guide

Advanced Guide

1 Camera Basics

2 Auto Mode / Hybrid Auto Mode

3 Other Shooting Modes

4 P Mode

5 Tv, Av, M, and C Modes

6 Playback Mode

7 Wi-Fi Functions

8 Set-Up Menu

9 Accessories

10 Appendix

Index



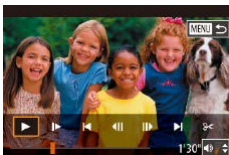

- To stop movie playback, touch the screen. This screen is displayed, and the camera is ready for your next operation.
 - Touch [🔊] to display the volume panel, and then touch [▲][▼] to adjust the volume.
 - To switch frames, touch the scrollbar or drag left or right.
 - To resume playback, touch ▶].
 - Touch [↶] to return to the screen in step 2 of “Viewing” (📖93).

Switching Display Modes

Press the [INFO] button in playback mode to switch between no information display, information display 1 (basic info), and information display 2 (details).



- Switching display modes is not possible while the camera is connected via Wi-Fi to devices other than printers.

Defining Displayed Shooting Data

You can set up the screens to display the information you want. For details on the information displayed on each screen, see “Playback” (📖175).

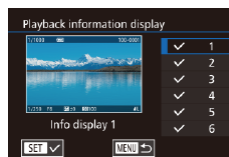
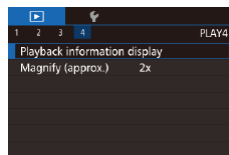

1 Access the setting screen.

- Select [Playback information display] on the [▶4] tab and press the [INFO] button.

2 Select the information to display.

- Press the [▲][▼] buttons or turn the [🌀] dial to choose the info you want displayed and then press the [INFO] button to add a [✓].
- To return to the menu screen, press the [MENU] button.



- Use the display sample on the left side of the screen to see what your selected effect in step 2 will look like.
- Place a [✓] on [Info display 2] to display settings info from [🌟] mode. When you press the [INFO] button, you will see [🌟] settings, followed by [Info Display 2].

Before Use

Basic Guide

Advanced Guide

1 Camera Basics

2 Auto Mode / Hybrid Auto Mode

3 Other Shooting Modes

4 P Mode

5 Tv, Av, M, and C Modes

6 Playback Mode

7 Wi-Fi Functions

8 Set-Up Menu

9 Accessories

10 Appendix

Index



Overexposure Warning (for Image Highlights)

▶ Still Images ▶ Movies

Washed-out highlights in the image flash on the screen in info displays 2 to 6 (📖95).

Brightness Histogram

▶ Still Images ▶ Movies

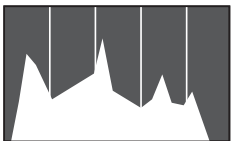

- The graph displayed on the top of information displays 2-6 is a histogram that shows the distribution of brightness in the image. The horizontal axis represents the degree of brightness, and the vertical axis, how much of the image is at each level of brightness. Viewing the histogram is a way to check exposure.

RGB Histogram

▶ Still Images ▶ Movies

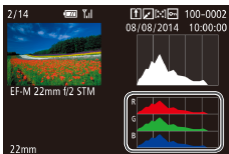

- Information display 3 displays an RGB histogram that shows the distribution of shades of red, green, and blue in an image. The horizontal axis represents R, G, or B brightness, and the vertical axis, how much of the image is at that level of brightness. Viewing this histogram enables you to check image color characteristics.



- Choose info displays 2 – 6 from the [Playback information display] screen on the [📷4] tab, press the [INFO] button, press the [▲][▼] buttons to choose [RGB], and then press the [🔍] button. The brightness histogram will then be displayed on the bottom of info display 3.
- The histogram can also be accessed while shooting (📖174).

Viewing Short Movies Created When Shooting Still Images (Digest Movies)

▶ Still Images ▶ Movies

View digest movies recorded automatically in [📷] mode (📖37) on a day of still image shooting as follows.



1 Choose an image.

- Still images shot in [📷] mode are labeled with a [SET] icon.
- Choose a still image labeled with [SET] and press the [🔍] button.

2 Play the movie.

- Press the [🔍] button, and then choose [📷] in the menu (📖31).
- The movie recorded automatically on the day of still image shooting is played back, from the beginning.



- After a moment, [SET] will no longer be displayed when you are using the camera with information display deactivated (📖95).



- You can also play digest movies by touching [SET] on the screen in step 1 and touching [SET] on the screen in step 2.

Before Use

Basic Guide

Advanced Guide

1 Camera Basics

2 Auto Mode / Hybrid Auto Mode

3 Other Shooting Modes

4 P Mode

5 Tv, Av, M, and C Modes

6 Playback Mode

7 Wi-Fi Functions

8 Set-Up Menu

9 Accessories

10 Appendix

Index



Viewing by Date

Digest movies can be viewed by date.

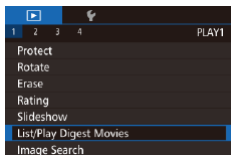

1 Choose a movie.

- Press the [MENU] button, choose [List/Play Digest Movies] on the [1] tab, and then choose a date (132).

2 Play the movie.

- Press the [OK] button to start playback.

Browsing and Filtering Images

Navigating through Images in an Index

► Still Images ► Movies

By displaying multiple images in an index, you can quickly find the images you are looking for.



1 Display images in an index.

- Press the [Index] button to display images in an index. Press it again to increase the number of images shown.
- To display fewer images, press the [Q] button. Fewer images are shown with each press.

2 Choose an image.

- Turn the [Dial] dial to scroll through the images.
- Press the [▲][▼][◀][▶] buttons to choose an image.
- An orange frame is displayed around the selected image.
- Press the [OK] button to view the selected image in single-image display.



- To deactivate the 3D display effect (shown if you hold down the [▲][▼] buttons or turn the [Dial] dial rapidly), choose MENU (132) > [1]3 tab > [Index Effect] > [Off].

Before Use

Basic Guide

Advanced Guide

1 Camera Basics

2 Auto Mode / Hybrid Auto Mode

3 Other Shooting Modes

4 P Mode

5 Tv, Av, M, and C Modes

6 Playback Mode

7 Wi-Fi Functions

8 Set-Up Menu

9 Accessories

10 Appendix

Index



Touch-Screen Operations



- Pinch in to switch from single-image display to index display.
- To view more thumbnails per screen, pinch in again.
- Drag up or down on the screen to scroll through displayed images.
- To view fewer thumbnails per screen, spread your fingers apart.
- Touch an image to choose it, and touch it again to view it in single-image display.

Finding Images Matching Specified Conditions

► Still Images ► Movies

Find desired images quickly on a memory card full of images by filtering image display according to your specified conditions. You can also protect (📖102) or delete (📖105) these images all at once.

★ Rating	Displays images with defined ratings (📖108).
🕒 Shot Date	Displays the images shot on a specific date.
👤 People	Displays images with detected faces.
🎞 Still image/ Movie	Displays still images, movies, or movies shot in [📷] mode (📖37).



1 Choose the first condition for image display or navigation.

- Press the [📷] button, choose [👤] in the menu, press the [📷] button, and then press the [▲][▼] buttons to choose a condition.
- If you chose [👤], press the [◀][▶] buttons or turn the [🔘] dial to display the filtered images. To perform an action for all of these images together, press the [📷] button and go to step 3.

2 Choose the second condition and check the images found.

- If you selected [★], [🕒] or [👤] for your first condition, press the [◀][▶] buttons to select a second condition and then turn the [🔘] dial to view the images found.
- To switch to filtered image display, press the [📷] button and go to step 3.

Before Use

Basic Guide

Advanced Guide

1 Camera Basics

2 Auto Mode / Hybrid Auto Mode

3 Other Shooting Modes

4 P Mode

5 Tv, Av, M, and C Modes

6 Playback Mode

7 Wi-Fi Functions

8 Set-Up Menu

9 Accessories

10 Appendix

Index



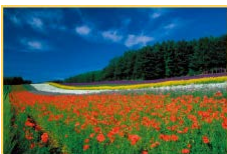

3 View the filtered images.

- Images matching your conditions are displayed in yellow frames. To view only these images, press the [◀][▶] buttons or turn the [DISP.] dial.
- To leave the filtered image display, press the [DISP.] button, select [OK] from the menu, and then press the [DISP.] button.



- When the camera has found no corresponding images for some conditions, those conditions will not be available.



- To hide or view other information, press the [INFO] button in step 2.
- Options for viewing the images found (in step 3) include "Navigating through Images in an Index" (109), "Magnifying Images" (100), and "Viewing Slideshows" (101). You can also apply image operations to all images found, by choosing [Protect All Images in Search] in "Protecting Images" (102), "Erasing Multiple Images at Once" (105), "Adding Images to the Print List (DPOF)" (164), or [Select All Images in Search] in "Adding Images to a Photobook" (166).
- If you edit images and save them as new images (109 – 112), a message is displayed, and the images that were found are no longer shown.
- Press the [MENU] button and select [Image Search] on the [1] tab for the same function.



- You can also choose conditions by touching the screens in steps 1 and 2.

Using the Front Dial to Jump between Images

	Displays images with defined ratings (108).
	Jumps to the first image in each group of images that were shot on the same date.
	Jumps by 10 images at a time.
	Jumps by 100 images at a time.



1 Choose a condition.

- Choose a condition (or jump method) in single-image display by turning the [DISP.] dial and then pressing the [▲][▼] buttons.

2 View images matching your specified condition, or jump by the specified amount.

- Turn the [DISP.] dial to view only images matching the condition or jump by the specified number of images forward or back.



- [1], [2], [3], [4], and [5] are displayed when there are images for each corresponding rating. [★] and [★] are displayed whenever there are any images with ratings applied to them.
- [★] allows you to jump to the Favorites screen with all ratings displayed.
- Turning the [DISP.] dial when browsing images in index display will jump to the previous or next image according to the jump method chosen in single-image display. However, if you have chosen [10] or [100], the jump method will be switched to [DISP.].

Before Use

Basic Guide

Advanced Guide

1 Camera Basics

2 Auto Mode / Hybrid Auto Mode

3 Other Shooting Modes

4 P Mode

5 Tv, Av, M, and C Modes

6 Playback Mode

7 Wi-Fi Functions

8 Set-Up Menu

9 Accessories

10 Appendix

Index



Touch-Screen Operations



- You can also jump to the previous or next image according to your jump method chosen in step 1 of “Using the Front Dial to Jump between Images” (p.99) by dragging left or right with two fingers.

Image Viewing Options

Magnifying Images

► Still Images ► Movies



(1)

1 Magnify an image.

- Pressing the [Q] button will zoom in and magnify the image. You can magnify images up to about 10x by continuing to hold the button down.
- The approximate position of the displayed area (1) is shown for reference.
- To zoom out, press the [] button. You can return to single-image display by continuing to hold it.

2 Move the display position and switch images as needed.

- To move the display position, press the [▲][▼][◀][▶] buttons. Press [Ⓢ] to move to the focus frame area used when shooting.
- To switch to other images while zoomed, turn the [] dial.



- You can return to single-image display from magnified display by pressing the [MENU] button.
- Go to [Magnify (approx.)] on the []4 tab of the menu to define the magnification used when pressing the [Q] button during single-image display. If set to [Reuse last magnification], the display will be magnified to the level before the [MENU] button was pressed in the previous magnified image.

Before Use

Basic Guide

Advanced Guide

1 Camera Basics

2 Auto Mode / Hybrid Auto Mode

3 Other Shooting Modes

4 P Mode

5 Tv, Av, M, and C Modes

6 Playback Mode

7 Wi-Fi Functions

8 Set-Up Menu

9 Accessories

10 Appendix

Index



Touch-Screen Operations



- Spread your fingers apart (pinch out) to zoom in.
- You can magnify images up to about 10x by repeating this action.
- To move the display position, drag across the screen.



- Pinch in to zoom out.
- Touch [MENU] to restore single-image display.

Viewing Slideshows

▶ Still Images ▶ Movies

Automatically play back images from a memory card as follows.

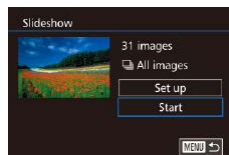

- Press the [MENU] button, and then choose [Slideshow] on the [1] tab (32).
- Press the [▲][▼] buttons or turn the [DISP] dial to choose [Start], and then press the [DISP] button.
- The slideshow will start after [Loading image] is displayed for a few seconds.
- Press the [MENU] button to stop the slideshow.



- The camera's power-saving functions (328) are deactivated during slideshows.



- To pause or resume slideshows, press the [DISP] button.
- You can switch to other images during playback by pressing the [◀][▶] buttons or turning the [DISP] dial. For fast-forward or fast-rewind, hold the [◀][▶] buttons down.
- Choose [Set up] and press the [DISP] button to set up slideshows to repeat, change the transitions between images, and adjust the display duration of each image (32).



- You can also stop slideshows by touching the screen.

Before Use

Basic Guide

Advanced Guide

1 Camera Basics

2 Auto Mode / Hybrid Auto Mode

3 Other Shooting Modes

4 P Mode

5 Tv, Av, M, and C Modes

6 Playback Mode

7 Wi-Fi Functions

8 Set-Up Menu

9 Accessories

10 Appendix

Index



Protecting Images

▶ Still Images ▶ Movies

Protect important images to prevent accidental erasure (105).



- Press the [MENU] button, select [Protect] from the menu, and then use the [Left] [Right] buttons or turn the [Dial] dial to select [Protect]. This will display the [Protect] icon.
- Press the [OFF] button again to remove the [Protect] icon and unprotect the image.



- Protected images on a memory card will be erased if you format the card (138).



- Protected images cannot be erased using the camera's erasure function. To erase them this way, first cancel protection.

Using the Menu

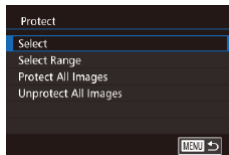
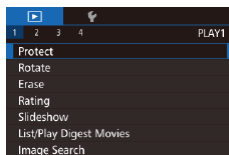

1 Access the setting screen.

- Press the [MENU] button and choose [Protect] on the [1] tab (32).

2 Choose a selection method.

- Choose an option as desired (32).
- To return to the menu screen, press the [MENU] button.

Before Use

Basic Guide

Advanced Guide

1 Camera Basics

2 Auto Mode / Hybrid Auto Mode

3 Other Shooting Modes

4 P Mode

5 Tv, Av, M, and C Modes

6 Playback Mode

7 Wi-Fi Functions

8 Set-Up Menu

9 Accessories

10 Appendix

Index



Choosing Images Individually

1 Choose [Select].

- Following step 2 in “Using the Menu” (102), choose [Select] and press the [MENU] button.



2 Choose an image.

- Press the [◀][▶] buttons or turn the [DISP] dial to choose an image, and then press the [MENU] button. [Protect] is displayed.
- To cancel selection, press the [DISP] button again. [Protect] is no longer displayed.
- Repeat this process to specify other images.

3 Protect the image.

- Press the [MENU] button. A confirmation message is displayed.
- Press the [◀][▶] buttons or turn the [DISP] dial to choose [OK], and then press the [DISP] button.

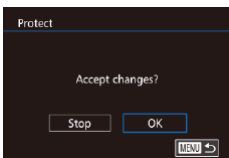

- Images will not be protected if you switch to Shooting mode or turn the camera off before finishing the setup process in step 3.



- You can also select or clear images by touching the screen in step 2, and you can access the confirmation screen by touching [MENU].
- You can also protect images by touching [OK] on the screen in step 3.

Selecting a Range

1 Choose [Select Range].

- Following step 2 in “Using the Menu” (102), choose [Select Range] and press the [MENU] button.

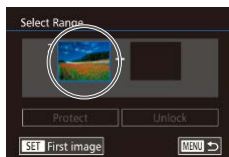

2 Choose a starting image.

- Press the [MENU] button.



- Press the [◀][▶] buttons or turn the [DISP] dial to choose an image, and then press the [MENU] button.

Before Use

Basic Guide

Advanced Guide

1 Camera Basics

2 Auto Mode / Hybrid Auto Mode

3 Other Shooting Modes

4 P Mode

5 Tv, Av, M, and C Modes

6 Playback Mode

7 Wi-Fi Functions

8 Set-Up Menu

9 Accessories

10 Appendix

Index



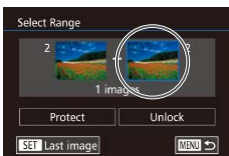

3 Choose an ending image.

- Press the [▶] button to choose [Last image], and then press the [ⓘ] button.



- Press the [◀][▶] buttons or turn the [ⓘ] dial to choose an image, and then press the [ⓘ] button.
- Images before the first image cannot be selected as the last image.

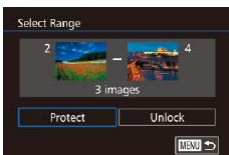

4 Protect the images.

- Press the [▼] button to choose [Protect], and then press the [ⓘ] button.



- You can also choose the first or last image by turning the [ⓘ] dial when the top screen in steps 2 and 3 is displayed.
- To cancel protection for groups of images, choose [Unlock] in step 4.



- You can also display the screen for choosing the first or last image by touching an image on the top screen in steps 2 or 3.
- You can also protect images by touching [Protect] on the screen in step 4.

Protecting All Images at Once

1 Choose [Protect All Images].

- Following step 2 in “Using the Menu” (102), choose [Protect All Images] and press the [ⓘ] button.

2 Protect the images.

- Press the [◀][▶] buttons or turn the [ⓘ] dial to choose [OK], and then press the [ⓘ] button.

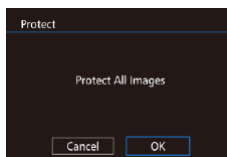

Clearing All Protection at Once

You can clear protection from all images at once. To clear protection, choose [Unprotect All Images] in step 1 of “Protecting All Images at Once”, and then complete step 2.

Before Use

Basic Guide

Advanced Guide

1 Camera Basics

2 Auto Mode / Hybrid Auto Mode

3 Other Shooting Modes

4 P Mode

5 Tv, Av, M, and C Modes

6 Playback Mode

7 Wi-Fi Functions

8 Set-Up Menu

9 Accessories

10 Appendix

Index



Erasing Images

▶ Still Images ▶ Movies

You can choose and erase unneeded images one by one. Be careful when erasing images, because they cannot be recovered. However, protected images (📖102) cannot be erased.

1 Choose an image to erase.

- Press the [◀][▶] buttons or turn the [🔍] dial to choose an image.

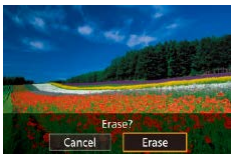

2 Erase the image.

- Press the [▼] button.
- After [Erase?] is displayed, press the [◀][▶] buttons or turn the [🔍] dial to choose [Erase], and then press the [🔍] button.
- The current image is now erased.
- To cancel erasure, press the [◀][▶] buttons or turn the [🔍] dial to choose [Cancel], and then press the [🔍] button.



- Press the [▼] button when displaying an image with both RAW and JPEG files to select between [Erase RAW], [Erase JPEG] or [Erase RAW + JPEG]. Select your preferred option to erase the files.



- You can also erase the current image by touching [Erase] on the screen in step 2.

Erasing Multiple Images at Once

You can choose multiple images to erase at once. Be careful when erasing images, because they cannot be recovered. However, protected images (📖102) cannot be erased.

Choosing a Selection Method

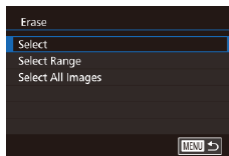
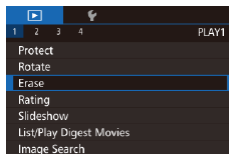

1 Access the setting screen.

- Press the [MENU] button, and then choose [Erase] on the [▶] 1 tab (📖32).

2 Choose a selection method.

- Press the [▲][▼] buttons or turn the [🔍] dial to choose a selection method, and then press the [🔍] button.
- To return to the menu screen, press the [MENU] button.

Choosing Images Individually



1 Choose [Select].

- Following step 2 in “Choosing a Selection Method” (📖105), choose [Select] and press the [🔍] button.

2 Choose an image.

- Once you choose an image following step 2 in “Choosing Images Individually” (📖103), [✓] is displayed.
- To cancel selection, press the [🔍] button again. [✓] is no longer displayed.

Before Use

Basic Guide

Advanced Guide

1 Camera Basics

2 Auto Mode / Hybrid Auto Mode

3 Other Shooting Modes

4 P Mode

5 Tv, Av, M, and C Modes

6 Playback Mode

7 Wi-Fi Functions

8 Set-Up Menu

9 Accessories

10 Appendix

Index



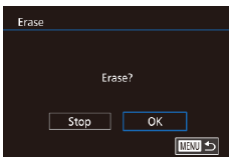

- Repeat this process to specify other images.

3 Erase the image.

- Press the [MENU] button. A confirmation message is displayed.
- Press the [◀][▶] buttons or turn the [DISP] dial to choose [OK], and then press the [DISP] button.



- If you select an image with both RAW and JPEG files, both will be erased.

Selecting a Range

1 Choose [Select Range].

- Following step 2 in “Choosing a Selection Method” (105), choose [Select Range] and press the [DISP] button.

2 Choose images.

- Follow steps 2 – 3 in “Selecting a Range” (103) to specify images.

3 Erase the images.

- Press the [▼] button to choose [Erase], and then press the [DISP] button.

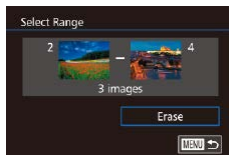

Specifying All Images at Once

1 Choose [Select All Images].

- Following step 2 in “Choosing a Selection Method” (105), choose [Select All Images] and press the [DISP] button.

2 Erase the images.

- Press the [◀][▶] buttons or turn the [DISP] dial to choose [OK], and then press the [DISP] button.

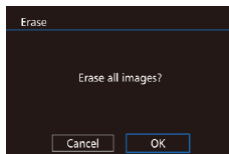

Before Use

Basic Guide

Advanced Guide

1 Camera Basics

2 Auto Mode /
Hybrid Auto Mode

3 Other Shooting Modes

4 P Mode

5 Tv, Av, M, and C Modes

6 Playback Mode

7 Wi-Fi Functions

8 Set-Up Menu

9 Accessories

10 Appendix

Index



Rotating Images

▶ Still Images ▶ Movies

Change the orientation of images and save them as follows.



1 Choose [Rotate].

- Press the [MENU] button, and then choose [Rotate] in the menu (📖31).

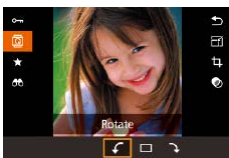

2 Rotate the image.

- Press the [◀][▶] buttons or turn the [DISP] dial to select [↻] or [↺] and rotate the image 90° in the specified direction. Press the [OK] button to confirm the rotation.



- Rotation is not possible when [Auto Rotate] is set to [Off] (📖108).

Using the Menu

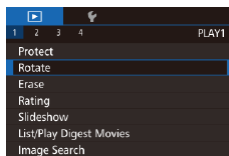

1 Choose [Rotate].

- Press the [MENU] button and choose [Rotate] on the [▶] 1 tab (📖32).

2 Rotate the image.

- Press the [◀][▶] buttons or turn the [DISP] dial to choose an image.
- Press the [OK] button to rotate the image 90° clockwise. Press it again to rotate it 90° counterclockwise, and press it a third time to restore the image to normal.
- To return to the menu screen, press the [MENU] button.



- On the screen in step 2, you can also touch [SET] to rotate images or touch [MENU] to return to the menu screen.

Before Use

Basic Guide

Advanced Guide

1 Camera Basics

2 Auto Mode / Hybrid Auto Mode

3 Other Shooting Modes

4 P Mode

5 Tv, Av, M, and C Modes

6 Playback Mode

7 Wi-Fi Functions

8 Set-Up Menu

9 Accessories

10 Appendix

Index



Deactivating Auto Rotation

Follow these steps to deactivate automatic image rotation, which rotates images based on the current camera orientation.

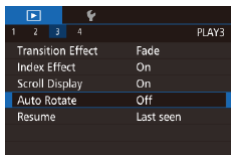

- Press the [MENU] button, choose [Auto Rotate] on the [▶]3 tab, and then choose [Off] (📖32).



- Images cannot be rotated (📖107) when you set [Auto Rotate] to [Off]. Additionally, images already rotated will be displayed in the original orientation.

Applying Ratings

▶ Still Images ▶ Movies

You can organize images by giving them ratings (levels). These levels run between [OFF], [★], [★★], [★★★], [★★★★] and [★★★★★]. By choosing a rating, you can restrict the following operations to all images with the same rating.

- “Viewing” (📖93), “Viewing Slideshows” (📖101), “Protecting Images” (📖102), “Erasing Images” (📖105), “Adding Images to the Print List (DPOF)” (📖164), “Adding Images to a Photobook” (📖166)
- Press the [📷] button, choose [★] in the menu, and then assign a rating (📖31).
- To remove ratings, repeat this process but choose [OFF] and then press the [📷] button.



Using the Menu

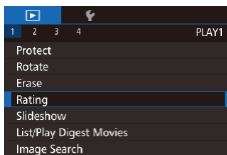

1 Choose [Rating].

- Press the [MENU] button and choose [Rating] on the [▶]1 tab (📖32).

2 Choose image and rating.

- Press the [◀][▶] buttons or turn the [📷] dial to choose an image, and then press the [▲][▼] buttons to choose a rating.

Before Use

Basic Guide

Advanced Guide

1 Camera Basics

2 Auto Mode / Hybrid Auto Mode

3 Other Shooting Modes

4 P Mode

5 Tv, Av, M, and C Modes

6 Playback Mode

7 Wi-Fi Functions

8 Set-Up Menu

9 Accessories

10 Appendix

Index



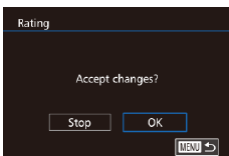

3 Finish the setup process.

- Press the [MENU] button. A confirmation message is displayed.
- Press the [◀][▶] buttons or turn the [⏻] dial to choose [OK], and then press the [⏻] button.



- Images will not be rated if you switch to Shooting mode or turn the camera off before finishing the setup process in step 3.



- In step 2, you can also rate images by touching the [▲][▼] buttons.

Editing Still Images



- Image editing (📖109 – 📖112) is only available when the memory card has sufficient free space.



- When [SET] is shown on a screen, you can touch [SET] instead of pressing the [⏻] button, if you prefer.
- When [MENU] is shown on a screen, you can touch [MENU] instead of pressing the [MENU] button, if you prefer.

Resizing Images

▶ Still Images ▶ Movies

Save a copy of images at a lower number of recording pixels.

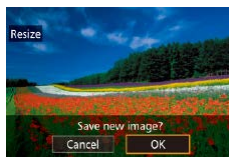

1 Choose an image size.

- Press the [⏻] button, choose [F] in the menu, and choose a size (📖31).
- Press the [⏻] button.

2 Save the new image.

- After [Save new image?] is displayed, press the [◀][▶] buttons or turn the [⏻] dial to choose [OK], and then press the [⏻] button.

Before Use

Basic Guide

Advanced Guide

1 Camera Basics

2 Auto Mode / Hybrid Auto Mode

3 Other Shooting Modes

4 P Mode

5 Tv, Av, M, and C Modes

6 Playback Mode

7 Wi-Fi Functions

8 Set-Up Menu

9 Accessories

10 Appendix

Index



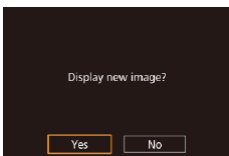

3 Review the new image.

- Press the [◀][▶] buttons or turn the [DISP] dial to choose [Yes], and then press the [OK] button.
- The saved image is now displayed.



- Editing is not possible for images shot at a recording pixel setting of [S3] (p143).
- RAW images cannot be edited.



- In step 1, choose [OFF] to stop resizing the image.
- Images cannot be resized to a higher number of recording pixels.

Using the Menu

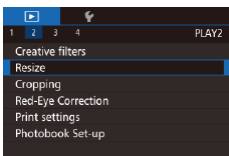

1 Choose [Resize].

- Press the [MENU] button and choose [Resize] on the [▶] tab (p32).

2 Choose an image.

- Press the [◀][▶] buttons or turn the [DISP] dial to choose an image, and then press the [OK] button.

3 Choose an image size.

- Press the [◀][▶] buttons or turn the [DISP] dial to choose the size, and then press the [OK] button.

4 Save as a new image and review.

- Follow step 2 in “Resizing Images” (p109).
- Press the [MENU] button, and then follow step 3 in “Resizing Images” (p109).



Cropping

▶ Still Images ▶ Movies

You can specify a portion of an image to save as a separate image file.

1 Access the setting screen.

- Press the [OK] button, choose [C] in the menu, and then press the [OK] button (p31).

2 Set the cropping frame size, position, and aspect ratio.

- Press the [Q] or [C] button to change the size of the frame.
- Use the [▲][▼][◀][▶] buttons to move the frame.
- To change the orientation of the frame, turn the [DISP] dial to choose [C] and press the [OK] button.
- To change the frame's aspect ratio, turn the [DISP] dial to choose [A]. The aspect ratio will switch between ([3:2])[16:9][4:3][1:1] with each press of the [OK] button.

3 Check the cropped image.

- Turn the [DISP] dial to choose [C].
- Press [OK] to toggle the screen between the cropped image and the cropping frame display.



Before Use

Basic Guide

Advanced Guide

1 Camera Basics

2 Auto Mode / Hybrid Auto Mode

3 Other Shooting Modes

4 P Mode

5 Tv, Av, M, and C Modes

6 Playback Mode

7 Wi-Fi Functions

8 Set-Up Menu

9 Accessories

10 Appendix

Index



4 Save as a new image and review.

- Turn the [●] dial to choose [L], and then press the [●] button.
- Follow steps 2 – 3 in “Resizing Images” (109).



- Editing is not possible for images shot at [S3] resolution.
- RAW images cannot be edited.
- You cannot crop an image that has already been cropped.
- You cannot apply a Creative filter or resizing to a cropped image.



- Cropped images will have a lower number of recording pixels than uncropped images.
- In step 3, while the cropped image is displayed, you can still change the crop position, size and aspect ratio.
- Step 2 can also be performed by pressing the [MENU] button, choosing [Cropping] on the [2] tab, pressing the [●] button, selecting an image and pressing [●] again.



- In step 2, you can move the frame by dragging it around the screen. Pinch or spread out your fingers (101) to change the size of the frame.
- In step 2, you can also touch [L], [R], [M], or [L] on the screen.

Applying Filter Effects

You can apply the effects of the following shooting modes to an image and save it as a new image: [L], [R], [M], [L], [L], [L], [L], and [L].

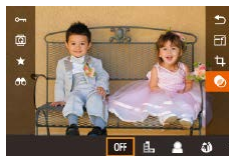

1 Select the effect type.

- Press the [●] button, choose [●] in the menu, and choose an effect type (31).
- Press the [●] button.

2 Configure details.

- For [L] mode, press the [L][R] buttons or turn the [●] dial to adjust the contrast.
- For [R] mode, press the [L][R] buttons or turn the [●] dial to adjust blurring.
- For [M] or [L] modes, press the [L][R] buttons or turn the [●] dial to adjust the strength of the effect.
- For [L] mode, press the [L][R] buttons or turn the [●] dial to adjust the intensity of the colors.
- For [L] mode, press the [L][R] buttons or turn the [●] dial to adjust the color tone.
- For [L], press the [INFO.] button to resize the frame and press the [▲][▼] buttons to move it.

Before Use

Basic Guide

Advanced Guide

1 Camera Basics

2 Auto Mode / Hybrid Auto Mode

3 Other Shooting Modes

4 P Mode

5 Tv, Av, M, and C Modes

6 Playback Mode

7 Wi-Fi Functions

8 Set-Up Menu

9 Accessories

10 Appendix

Index



3 Save as a new image and review.

- Press the **[G]** button.
- Follow steps 2 – 3 in “Resizing Images” (📖109).



- To switch the orientation of the frame to vertical in **[L]** mode, press the **[◀][▶]** buttons in step 2. To move the frame, press the **[◀][▶]** buttons again. To return the frame to horizontal orientation, press the **[▲][▼]** buttons.
- This can also be done by pressing the **[MENU]** button, selecting **[Creative filters]** on the **[▶]1** tab, selecting an image and pressing the **[G]** button.
- In step 1, choose **[OFF]** to not apply an effect to the image.



- In step 2, you can also touch and drag the bar across the bottom of the screen to edit images. You can also move the frame by touching or dragging across the screen in **[L]** mode.

Correcting Red-Eye

▶ Still Images ▶ Movies

Automatically corrects images affected by red-eye. You can save the corrected image as a separate file.

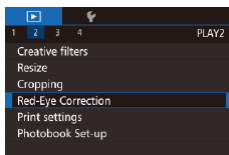

1 Choose [Red-Eye Correction].

- Press the **[MENU]** button, and then choose **[Red-Eye Correction]** on the **[▶]2** tab (📖32).

2 Choose an image.

- Press the **[◀][▶]** buttons or turn the **[DIAL]** dial to choose an image.

3 Correct the image.

- Press the **[G]** button.
- Red-eye detected by the camera is now corrected, and frames are displayed around corrected image areas.

- Enlarge or reduce images as needed. Follow the steps in “Magnifying Images” (📖100).

4 Save as a new image and review.

- Press the **[▲][▼][◀][▶]** buttons or turn the **[DIAL]** dial to choose **[New File]**, and then press the **[G]** button.
- The image is now saved as a new file.
- Press the **[MENU]** button, and then follow step 3 in “Resizing Images” (📖109).



- Some images may not be corrected accurately.
- To overwrite the original image with the corrected image, choose **[Overwrite]** in step 4. In this case, the original image will be erased.
- Protected images cannot be overwritten.
- RAW images cannot be edited this way.
- Red-eye correction can be applied to JPEG images saved with RAW images, but the original image cannot be overwritten.



- You can save images by touching **[New File]** or **[Overwrite]** on the screen in step 4.

Before Use

Basic Guide

Advanced Guide

1 Camera Basics

2 Auto Mode / Hybrid Auto Mode

3 Other Shooting Modes

4 P Mode

5 Tv, Av, M, and C Modes

6 Playback Mode

7 Wi-Fi Functions

8 Set-Up Menu

9 Accessories

10 Appendix

Index



Editing Movies

▶ Still Images ▶ Movies

You can remove unneeded portions from the beginning and end of movies (excluding digest movies, 137).

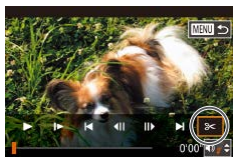

1 Choose [CUT].

- Following steps 1 – 5 in “Viewing” (193), choose [CUT] and press the [OK] button.
- The movie editing panel and editing bar are now displayed.



(1)

(2)

2 Specify portions to cut.

- (1) is the movie editing panel, and (2) is the editing bar.
- Press the [▲][▼] buttons to choose [L] or [R].
- To view the portions you can cut (identified by [L] on the screen), press the [◀][▶] buttons or turn the [DISC] dial to move [L]. Cut the beginning of the movie (from [L]) by choosing [L], and cut the end of the movie by choosing [R].
- If you move [L] to a position other than a [L] mark, in [L] the portion before the nearest [L] mark on the left will be cut, while in [R] the portion after the nearest [L] mark on the right will be cut.

3 Review the edited movie.

- Press the [▲][▼] buttons to choose [▶], and then press the [OK] button. The edited movie is now played.
- To edit the movie again, repeat step 2.

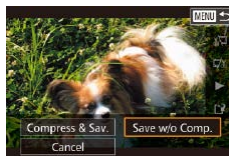
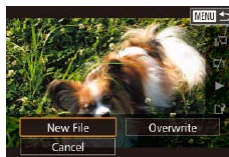

- To overwrite the original movie with the cut one, choose [Overwrite] in step 4. In this case, the original movie will be erased.
- If the memory card lacks sufficient space, only [Overwrite] will be available.
- Movies may not be saved if the battery pack runs out while saving is in progress.
- When editing movies, you should use a fully charged battery pack or an AC adapter kit (sold separately, 148).

- To cancel editing, press the [MENU] button, choose [OK] (either press the [◀][▶] buttons or turn the [DISC] dial), and then press the [OK] button again.

4 Save the edited movie.

- Press the [▲][▼] buttons to choose [L], and then press the [OK] button.
- Press the [▲][▼][◀][▶] buttons or turn the [DISC] dial to choose [New File], and then press the [OK] button.
- Choose [Save w/o Comp.], and then press the [OK] button.
- The movie is now saved as a new file.

Before Use

Basic Guide

Advanced Guide

1 Camera Basics

2 Auto Mode / Hybrid Auto Mode

3 Other Shooting Modes

4 P Mode

5 Tv, Av, M, and C Modes

6 Playback Mode

7 Wi-Fi Functions

8 Set-Up Menu

9 Accessories

10 Appendix

Index



Reducing File Sizes

Movie file sizes can be reduced by compressing movies as follows.

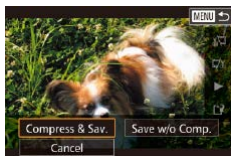

- On the screen in step 2 of “Editing Movies”, choose [L]. Choose [New File], and then press the [OK] button.
- Choose [Compress & Sav.], and then press the [OK] button.

Image quality after compression is as follows.

Pre-compression	Post-compression
FHD 29.97P	FHD 29.97P
FHD 23.98P	FHD 23.98P
FHD 59.94P	FHD 29.97P
FHD 25.00P	FHD 25.00P
FHD 50.00P	FHD 25.00P



- [VGA 29.97P] and [VGA 25.00P] movies cannot be compressed.
- Edited movies cannot be saved in compressed format when you choose [Overwrite].
- However, you can compress and save edited movies as new files by choosing [Compress & Sav.].

Editing Digest Movies

▶ Still Images ▶ Movies

Individual chapters (clips) (📖37) recorded in [A] mode can be erased as needed. Be careful when erasing clips, because they cannot be recovered.

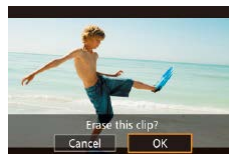
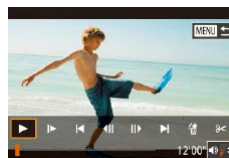

1 Select the clip to erase.

- Follow steps 1 – 2 in “Viewing Short Movies Created When Shooting Still Images (Digest Movies)” (📖96) to play a movie created in [A] mode, and then press the [OK] button to access the movie control panel.
- Press the [◀][▶] buttons or turn the [🔊] dial to choose [◀] or [▶], and then press the [OK] button.

2 Choose [🗑️].

- Press the [◀][▶] buttons or turn the [🔊] dial to choose [🗑️], and then press the [OK] button.
- The selected clip is played back repeatedly.

3 Confirm erasure.

- Press the [◀][▶] buttons or turn the [🔊] dial to choose [OK], and then press the [OK] button.
- The clip is erased, and the short movie is overwritten.



- [🗑️] is not displayed if you select a clip when the camera is connected to a printer.

Before Use

Basic Guide

Advanced Guide

1 Camera Basics

2 Auto Mode / Hybrid Auto Mode

3 Other Shooting Modes

4 P Mode

5 Tv, Av, M, and C Modes

6 Playback Mode

7 Wi-Fi Functions

8 Set-Up Menu

9 Accessories

10 Appendix

Index



7

Wi-Fi Functions

Send images wirelessly from the camera to a variety of compatible devices, and use the camera with Web services



- Before using the Wi-Fi function, ensure that you read the “Wi-Fi (Wireless LAN) Precautions” (1200).

Available Wi-Fi Features

You can send and receive images and control the camera remotely by connecting it to these devices and services via Wi-Fi.

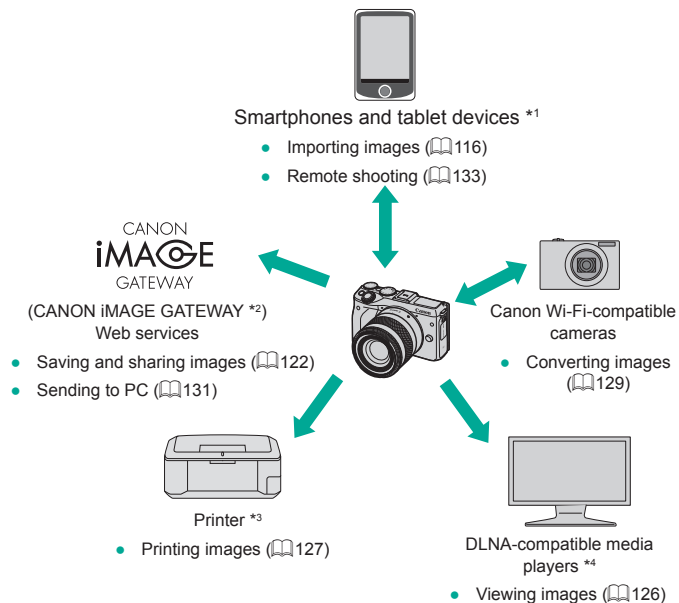

*1 For convenience in this manual, smartphones, tablets and other compatible devices are referred to collectively as “smartphones”.

*2 CANON iMAGE GATEWAY is Canon’s online photo service.

*3 The printer must support PictBridge (supporting DPS over IP), which allows direct photo printing via Wi-Fi.

*4 DLNA stands for Digital Living Network Alliance.

Before Use

Basic Guide

Advanced Guide

1 Camera Basics

2 Auto Mode / Hybrid Auto Mode

3 Other Shooting Modes

4 P Mode

5 Tv, Av, M, and C Modes

6 Playback Mode

7 Wi-Fi Functions

8 Set-Up Menu

9 Accessories

10 Appendix

Index



Importing Images into a Smartphone

There are the following two ways to import images from the camera into a smartphone.

- Connect via NFC (📖116)
Simply touch an NFC-compatible Android smartphone (OS version 4.0 or later) against the camera to connect the devices.
- Connect via the Wi-Fi menu (📖118)

Sending Images to an NFC-Compatible Smartphone

Use an Android (OS version 4.0 or later) smartphone's NFC to simplify the process of installing EOS Remote and connecting to the camera.

- If the camera is off or in Shooting mode when the devices are touched together, you can choose and transfer images from the camera to the smartphone. Once the devices are connected, you can also shoot remotely (📖133). It's easy to reconnect to recent devices, which are listed in the Wi-Fi menu.
- If the camera is in Playback mode when the devices are touched together, images appear in index display. You can choose and send images on the image selection screen.

Connecting via NFC When Camera Is Off or in Shooting Mode

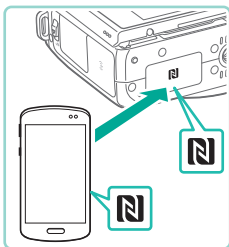

1 Install EOS Remote.

- Activate NFC on the smartphone and touch the device against the camera's N-Mark (N) to start Google Play on the smartphone automatically. Once the EOS Remote download page is displayed, download and install the app.

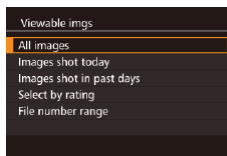
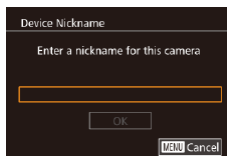

2 Establish the connection.

- Touch the N-Mark (N) on the smartphone with EOS Remote installed against the camera's N-Mark.
- The camera starts up automatically.
- When the [Device Nickname] screen is displayed, press the [OK] button. Use the keyboard (📖133) to enter a nickname, then press the [MENU] button to return to the [Device Nickname] screen.
- Press the [▲][▼] buttons or turn the [DISP] dial to choose [OK], and then press the [OK] button.
- EOS Remote starts up on the smartphone and automatically connects to the camera.

3 Adjust the privacy setting.

- When this screen is displayed, press the [▲][▼] buttons or turn the [DISP] dial to choose [All images], and then press the [OK] button.
- After a connection is established with the smartphone, this screen will close in about one minute.

4 Import images.

- Use the smartphone to import images from the camera to the smartphone.

Before Use

Basic Guide

Advanced Guide

1 Camera Basics

2 Auto Mode / Hybrid Auto Mode

3 Other Shooting Modes

4 P Mode

5 Tv, Av, M, and C Modes

6 Playback Mode

7 Wi-Fi Functions

8 Set-Up Menu

9 Accessories

10 Appendix

Index





- When using NFC, keep the following points in mind.
 - Avoid strong impact between the camera and smartphone. This may damage the devices.
 - Depending on the smartphone, the devices may not recognize each other immediately. In this case, try holding the devices together in slightly different positions. If connection fails, keep the devices together until the camera screen is updated.
 - Do not place other objects between the camera and smartphone. Also, note that camera or smartphone covers or similar accessories may block communication.
- Select [All images] in step 3 when shooting remotely.
- All images in the camera can be viewed from the connected smartphone when you choose [All images] in step 3. Select another option in step 3 to place restrictions on camera images viewable from the smartphone (135). Once you have registered a smartphone, you can change privacy settings for it on the camera (135).
- When the mode dial is set to P, a smartphone cannot be connected.



- Connections require that a memory card be in the camera.
- A message is displayed if the nickname you enter begins with a symbol or space. Press the [OK] button and enter a different nickname.

Connecting via NFC When Camera Is in Playback Mode

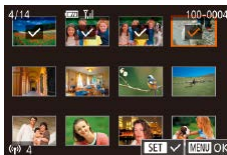

- Press the [▶] button to turn the camera on.
- Touch the smartphone with EOS Remote installed (119) against the camera's N-Mark (N).
- Press the [▲][▼][◀][▶] buttons to choose an image to send, and then press the [OK] button. [✓] is displayed.
- To cancel selection, press the [OK] button again. [✓] is no longer displayed.
- Repeat this process to choose additional images.
- After you finish choosing images, press the [MENU] button.
- Press the [◀][▶] buttons to choose [Send], and then press the [OK] button.
- The images are sent.
- To disconnect, remove the [✓] mark from all the images, press the [MENU] button, and then press [◀][▶] to choose [OK].



- If during connection a message on the camera or smartphone requests you to enter the nickname, follow step 2 in "Connecting via NFC When Camera Is Off or in Shooting Mode" (116) to enter it.
- The camera does not keep a record of smartphones you connect to via NFC in Playback mode.

Before Use

Basic Guide

Advanced Guide

1 Camera Basics

2 Auto Mode / Hybrid Auto Mode

3 Other Shooting Modes

4 P Mode

5 Tv, Av, M, and C Modes

6 Playback Mode

7 Wi-Fi Functions

8 Set-Up Menu

9 Accessories

10 Appendix

Index



Adding a Smartphone Using the Wi-Fi Menu

Before connecting to the camera, you must install the free dedicated “EOS Remote” app on the smartphone. For details on this application (supported smartphones and included functions), refer to the Canon website.

These steps show how to use the camera as an access point, but you can also use an existing access point (📖119).



1 Install the dedicated app.

- For Android smartphones, find EOS Remote in Google Play and download and install the app.
- For an iPhone or iPad, find EOS Remote in the App Store and download and install the app.

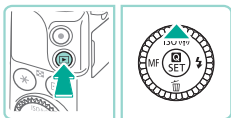

2 Access the Wi-Fi menu.

- Press the [▶] button to turn the camera on.
- Press the [▲] button.

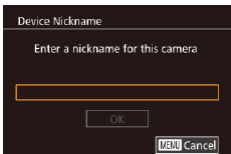

- When the [Device Nickname] screen is displayed, press the [Ⓜ] button. Use the keyboard (📖33) to enter a nickname, and then press the [MENU] button to return to the [Device Nickname] screen.
- Press the [▲][▼] buttons or turn the [🔘] dial to choose [OK], and then press the [Ⓜ] button.

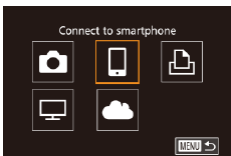

3 Choose [📱].

- Press the [▲][▼][◀][▶] buttons or turn the [🔘] dial to choose [📱], and then press the [Ⓜ] button.

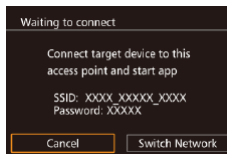
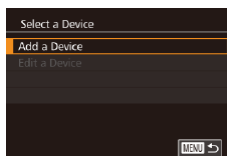

4 Choose [Add a Device].

- Press the [▲][▼] buttons or turn the [🔘] dial to choose [Add a Device], and then press the [Ⓜ] button.

- The camera's SSID and password are displayed.



5 Connect the smartphone to the network.

- In the smartphone's Wi-Fi setting menu, choose the SSID (network name) displayed on the camera to establish a connection.
- In the password field, enter the password displayed on the camera.



6 Start EOS Remote.

- Start EOS Remote on the smartphone.

7 Select the camera.

- A screen appears on the smartphone that lets you select which camera to connect to. Select the camera to begin pairing.

Before Use

Basic Guide

Advanced Guide

1 Camera Basics

2 Auto Mode / Hybrid Auto Mode

3 Other Shooting Modes

4 P Mode

5 Tv, Av, M, and C Modes

6 Playback Mode

7 Wi-Fi Functions

8 Set-Up Menu

9 Accessories

10 Appendix

Index



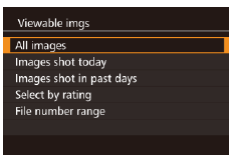

8 Adjust the privacy setting.

- When this screen is displayed, press the [▲][▼] buttons or turn the [🔒] dial to choose [All images], and then press the [🔒] button.
- After a connection is established with the smartphone, this screen will close in about one minute.



9 Import images.

- Use the smartphone to import images from the camera to the smartphone.



- Select [All images] in step 8 when shooting remotely.
- All images in the camera can be viewed from the connected smartphone when you choose [All images] in step 8. Select another option in step 8 to place restrictions on camera images viewable from the smartphone (📖135). Once you have registered a smartphone, you can change privacy settings for it on the camera (📖135).
- When the mode dial is set to [P], a smartphone cannot be connected.



- Connections require that a memory card be in the camera.
- A message is displayed if the nickname you enter begins with a symbol or space. Press the [🔒] button and enter a different nickname.
- To connect without entering a password in step 5, go to the menu (📖32), choose the [🔒] tab, and set [Password] to [Off] in [Wi-Fi Settings]. [Password] is no longer displayed in the SSID display screen (step 4).
- If you have previously connected to devices, recent destinations will be listed first when you access the Wi-Fi menu. You can easily connect again by pressing the [▲][▼] buttons to choose the device and then pressing the [🔒] button. To add a new device, display the device selection screen by touching [◀][▶], and then configure the setting.
- If you prefer not to display recent target devices, choose MENU (📖32) > [🔒] tab > [Wi-Fi Settings] > [Target History] > [Off].

Using Another Access Point

You can also use an existing access point when connecting the camera to a smartphone through the Wi-Fi menu. Also refer to the access point user manual.

Before Use

Basic Guide

Advanced Guide

1 Camera Basics

2 Auto Mode / Hybrid Auto Mode

3 Other Shooting Modes

4 P Mode

5 Tv, Av, M, and C Modes

6 Playback Mode

7 Wi-Fi Functions

8 Set-Up Menu

9 Accessories

10 Appendix

Index



Confirming Access Point Compatibility

Confirm that the Wi-Fi router or base station conforms to the Wi-Fi standards in “Wi-Fi” (📖194).

Connection methods vary depending on whether the access point supports Wi-Fi Protected Setup (WPS, 📖120) or not (📖121). For non-WPS access points, check the following information.

- Network name (SSID/ESSID)
The SSID or ESSID for the access point you use. Also called the “access point name” or “network name”.
- Network authentication / data encryption (encryption method / encryption mode)
The method for encrypting data during wireless transmission. Check which security setting is used: WPA2-PSK (AES), WPA2-PSK (TKIP), WPA-PSK (AES), WPA-PSK (TKIP), WEP (open system authentication), or no security.
- Password (encryption key / network key)
The key used when encrypting data during wireless transmission. Also called the “encryption key” or “network key”.
- Key index (transmit key)
The key set when WEP is used for network authentication / data encryption. Use “1” as the setting.



- If system administrator status is needed to adjust network settings, contact the system administrator for details.
- These settings are very important for network security. Exercise adequate caution when changing these settings.



- For information on WPS compatibility and for instructions on checking settings, refer to the access point user manual.
- A router is a device that creates a network (LAN) structure for connecting multiple computers. A router that contains an internal Wi-Fi function is called a “Wi-Fi router”.
- This guide refers to all Wi-Fi routers and base stations as “access points”.
- If you use MAC address filtering on your Wi-Fi network, be sure to add the camera’s MAC address to your access point. You can check your camera’s MAC address in the menu (📖32). Choose the [4] tab and select [Check MAC Address] in [Wi-Fi Settings].

Using WPS-Compatible Access Points

WPS makes it easy to complete settings when connecting devices over Wi-Fi. You can use either Push Button Configuration Method or PIN Method for settings on a WPS supported device.



1 Connect the smartphone to the access point.

2 Prepare for the connection.

- Follow steps 1 – 4 in “Adding a Smartphone Using the Wi-Fi Menu” (📖118) to access the [Waiting to connect] screen.

3 Choose [Switch Network].

- Press the [◀][▶] buttons or turn the [🌀] dial to choose [Switch Network], and then press the [🔑] button.
- A list of detected access points will be displayed.

4 Choose [WPS Connection].

- Press the [▲][▼] buttons or turn the [🌀] dial to choose [WPS Connection], and then press the [🔑] button.

5 Choose [PBC Method].

- Press the [▲][▼] buttons or turn the [🌀] dial to choose [PBC Method], and then press the [🔑] button.

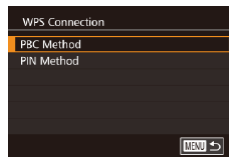
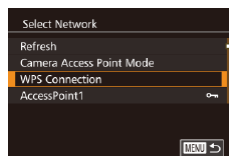
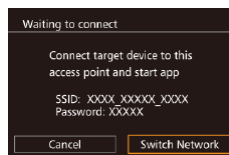

Before Use

Basic Guide

Advanced Guide

1 Camera Basics

2 Auto Mode / Hybrid Auto Mode

3 Other Shooting Modes

4 P Mode

5 Tv, Av, M, and C Modes

6 Playback Mode

7 Wi-Fi Functions

8 Set-Up Menu

9 Accessories

10 Appendix

Index



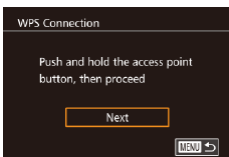

6 Establish the connection.

- On the access point, hold down the WPS connection button for a few seconds.
- On the camera, press the [Wi-Fi] button to go to the next step.

7 Import images.

- Follow steps 6 – 9 in “Adding a Smartphone Using the Wi-Fi Menu” (118) to choose the smartphone, adjust the privacy setting, and then import the images.



- If you chose [PIN Method] in step 5, a PIN code will be displayed on the screen. Be sure to set this code in the access point. Choose a device in the [Select a Device] screen. For further details, refer to the user manual included with your access point.

Connecting to Listed Access Points

1 View the listed access points.

- View the listed networks (access points) as described in steps 1 – 3 of “Using WPS-Compatible Access Points” (120).

2 Choose an access point.

- Press the [▲][▼] buttons or turn the [Wi-Fi] dial to choose a network (access point), and then press the [Wi-Fi] button.

3 Enter the access point password.

- Press the [Wi-Fi] button to access the keyboard and enter the password (33).
- Press the [▲][▼] buttons or turn the [Wi-Fi] dial to choose [Next], and then press the [Wi-Fi] button.

4 Choose [Auto].

- Press the [▲][▼] buttons or turn the [Wi-Fi] dial to choose [Auto], and then press the [Wi-Fi] button.

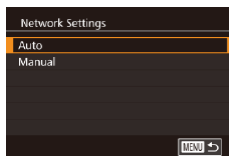
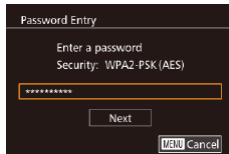
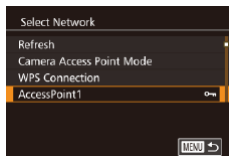

Before Use

Basic Guide

Advanced Guide

1 Camera Basics

2 Auto Mode / Hybrid Auto Mode

3 Other Shooting Modes

4 P Mode

5 Tv, Av, M, and C Modes

6 Playback Mode

7 Wi-Fi Functions

8 Set-Up Menu

9 Accessories

10 Appendix

Index



5 Import images.

- Follow steps 6 – 9 in “Adding a Smartphone Using the Wi-Fi Menu” (📖118) to select the smartphone to connect to and to configure the privacy settings, and then import the images.



- To determine the access point password, check on the access point itself or refer to the user manual.
- Up to 16 access points will be displayed. If no access points are detected even after you choose [Refresh] in step 2 to update the list, choose [Manual Settings] in step 2 to complete access point settings manually. Follow on-screen instructions and enter an SSID, security settings, and a password.
- When you reconnect to a previous access point, “*” is displayed for the password in step 3. To use the same password, choose [Next] (either press the [▲][▼] buttons or turn the [🌀] dial) and press the [📶] button.

Previous Access Points

To reconnect to a previous access point automatically, follow step 4 in “Adding a Smartphone Using the Wi-Fi Menu” (📖118).

- To use the camera as an access point, choose [Switch Network] on the screen displayed when you establish a connection, and then choose [Camera Access Point Mode].
- To use a different access point, select [Switch Network] on the screen displayed when you establish a connection, and then either follow step 4 in “Using WPS-Compatible Access Points” (📖120) or step 2 in “Connecting to Listed Access Points” (📖121).

Sending Images to a Registered Web Service

Registering Web Services

Use a smartphone or computer to add to the camera Web services that you want to use.

- A smartphone or computer with a browser and Internet connection is required to complete camera settings for CANON iMAGE GATEWAY and other Web services.
- Check the CANON iMAGE GATEWAY website for details on browser (Microsoft Internet Explorer, etc.) requirements, including settings and version information.
- For information on countries and regions where CANON iMAGE GATEWAY is available, visit the Canon website (<http://www.canon.com/cig/>).
- You must have an account with Web services other than CANON iMAGE GATEWAY if you desire to use them. For further details, check the websites for each Web service you want to register.
- Separate ISP connection and access point fees may be applicable.

Before Use

Basic Guide

Advanced Guide

1 Camera Basics

2 Auto Mode / Hybrid Auto Mode

3 Other Shooting Modes

4 P Mode

5 Tv, Av, M, and C Modes

6 Playback Mode

7 Wi-Fi Functions

8 Set-Up Menu

9 Accessories

10 Appendix

Index



Registering CANON iMAGE GATEWAY

After linking the camera and CANON iMAGE GATEWAY, add CANON iMAGE GATEWAY as a destination Web service on the camera.



1 Log in to CANON iMAGE GATEWAY and access the camera link settings page.

- From a computer or smartphone, access <http://www.canon.com/cig/> to visit CANON iMAGE GATEWAY.
- Once the login screen is displayed, enter your user name and password to log in. If you do not have a CANON iMAGE GATEWAY account, follow the instructions to complete member registration (free of charge).
- Access the camera settings page.



2 Choose the type of camera.

- On this camera model, [☁] is displayed in the Wi-Fi menu.
- Once you choose [☁], a page is displayed for entering the authentication code. On this page in step 7, you will enter the authentication code displayed on the camera after steps 3 – 6.

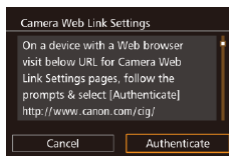
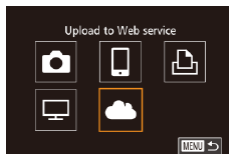
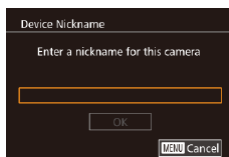
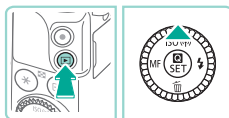

3 Access the Wi-Fi menu.

- Press the [▶] button to turn the camera on.
- Press the [▲] button.

- If the [Device Nickname] screen is displayed, press the [☁] button. Use the keyboard (⌨) to enter a nickname, and then press the [MENU] button to return to the [Device Nickname] screen.
- Press the [▲][▼] buttons or turn the [ⓘ] dial to choose [OK], and then press the [☁] button.

4 Choose [☁].

- Press the [▲][▼][◀][▶] buttons or turn the [ⓘ] dial to choose [☁], and then press the [☁] button.

5 Choose [Authenticate].

- Press the [◀][▶] buttons or turn the [ⓘ] dial to choose [Authenticate], and then press the [☁] button.

Before Use

Basic Guide

Advanced Guide

1 Camera Basics

2 Auto Mode / Hybrid Auto Mode

3 Other Shooting Modes

4 P Mode

5 Tv, Av, M, and C Modes

6 Playback Mode

7 Wi-Fi Functions

8 Set-Up Menu

9 Accessories

10 Appendix

Index



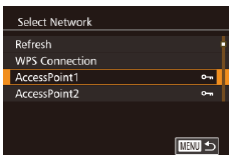

6 Establish a connection with an access point.

- Connect to the access point as described in steps 4 – 6 in “Using WPS-Compatible Access Points” (📖 120) or in steps 2 – 4 in “Connecting to Listed Access Points” (📖 121).
- Once the camera is connected to CANON iMAGE GATEWAY via the access point, an authentication code is displayed.
- Keep this display on and available for viewing until step 7 is complete.

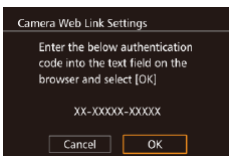

7 Enter the authentication code.

- On the smartphone or computer, enter the authentication code displayed on the camera and go to the next step.
- A six-digit confirmation number is displayed.

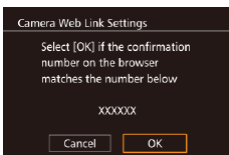

8 Check the confirmation number and complete the setup process.

- On the second screen in step 6, press the [◀][▶] buttons or turn the [🔘] dial to choose [OK], and then press the [📷] button to display the confirmation number.
- Make sure the confirmation number on the camera matches the number on the smartphone or computer.
- Press the [◀][▶] buttons or turn the [🔘] dial to choose [OK], and then press the [📷] button.
- Complete the setup process on the smartphone or computer.

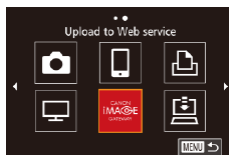

- CANON iMAGE GATEWAY and [📷] (📖 131) is now added as destinations, and the [📶] icon changes to [📶].
- A message is displayed on the smartphone or computer to indicate that this process is finished. To add other Web services, follow the procedure in “Registering Other Web Services” (📖 124) from step 2.



- Connections require that a memory card with saved images be in the camera.
- Once you have connected to devices via the Wi-Fi menu, recent destinations will be listed first when you access the menu. Press the [◀][▶] buttons to access the device selection screen and choose a device.

Registering Other Web Services

You can also add Web services besides CANON iMAGE GATEWAY to the camera. Note that CANON iMAGE GATEWAY must be registered on the camera first (📖 123).



1 Access the Web service settings screen.

- Follow step 1 in “Registering CANON iMAGE GATEWAY” (📖 123) to log in to CANON iMAGE GATEWAY, and then access the Web service settings screen.



2 Configure the Web service you want to use.

- Follow the instructions displayed on the smartphone or computer to set up the Web service.

Before Use

Basic Guide

Advanced Guide

1 Camera Basics

2 Auto Mode / Hybrid Auto Mode

3 Other Shooting Modes

4 P Mode

5 Tv, Av, M, and C Modes

6 Playback Mode

7 Wi-Fi Functions

8 Set-Up Menu

9 Accessories

10 Appendix

Index



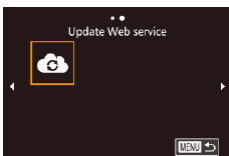

3 Choose [Wi-Fi].

- In Playback mode, press the [▲] button to access the Wi-Fi menu.
- Press the [▲][▼][◀][▶] buttons or turn the [DISP] dial to choose [Wi-Fi], and then press the [OK] button.
- The Web service settings are now updated.



- If any configured settings change, follow these steps again to update the camera settings.

Uploading Images to Web Services

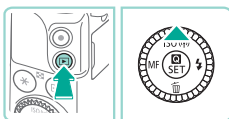

1 Access the Wi-Fi menu.

- Press the [▶] button to turn the camera on.
- Press the [▲] button.

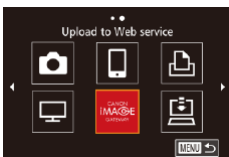

2 Choose the destination.

- Choose the icon of the Web service to connect to (either press the [▲][▼][◀][▶] buttons or turn the [DISP] dial), and then press the [OK] button.
- If multiple recipients or sharing options are used with a Web service, choose the desired item on the [Select Recipient] screen (either press the [▲][▼] buttons or turn the [DISP] dial), and then press the [OK] button.

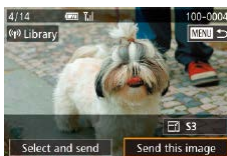

3 Send an image.

- Turn the [DISP] dial to choose an image to send, press the [◀][▶] buttons to choose [Send this image], and then press the [OK] button.
- When uploading to YouTube, read the terms of service, choose [I Agree], and press the [OK] button.
- Image transfer will begin. The screen darkens during image transfer.
- After the image is sent, [OK] is displayed. Press the [OK] button to return to the playback screen.



- Connections require that a memory card with saved images be in the camera.
- You can also send multiple images at once, resize images, and add comments before sending (p. 130).

Before Use

Basic Guide

Advanced Guide

1 Camera Basics

2 Auto Mode / Hybrid Auto Mode

3 Other Shooting Modes

4 P Mode

5 Tv, Av, M, and C Modes

6 Playback Mode

7 Wi-Fi Functions

8 Set-Up Menu

9 Accessories

10 Appendix

Index



Viewing Images Using a Media Player

You can view images in your camera's memory card on a TV or other device.

This function requires a DLNA-compatible TV set, game system, smartphone, or other media player. In this manual, the term “media player” is used to refer to any such device.

Follow these instructions only after the media player is connected to an access point. For information about settings and configuration, refer to the documentation provided with the device.

1 Access the Wi-Fi menu.

- Follow step 2 of “Adding a Smartphone Using the Wi-Fi Menu” (118) to display the Wi-Fi menu.

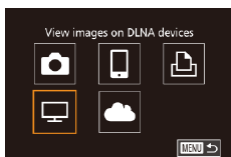

2 Choose [TV].

- Press the [▲][▼][◀][▶] buttons or turn the [DISK] dial to choose [TV], and then press the [OK] button.

3 Establish a connection with an access point.

- Connect to the access point as described in steps 4 – 6 of “Using WPS-Compatible Access Points” (120) or in steps 2 – 4 of “Connecting to Listed Access Points” (121).

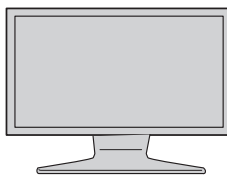
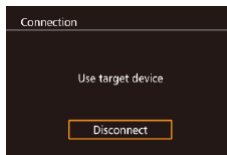
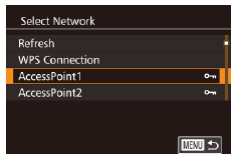

- Once the media player is accessible, this screen is displayed. The screen will darken after a period of time.
- Perform operations on the media player once connected. For details on controlling the media player, refer to its instruction manual.

4 Display the media player settings screen on your TV set.

- Use your media player to bring up [EOS M3] on the TV screen.
- A different icon may be displayed depending on the media player. Locate the icon labeled [EOS M3].

5 Display images.

- Choose [EOS M3], the memory card (SD or other card), the folder, and then the image to view.
- Select an image to display it on the TV. For details, refer to the media player's instruction manual.
- Press the [OK] button to close the connection with the camera. If the screen is darkened, press any button to bring up the second screen shown in step 3 above, and then press the [OK] button.

Before Use

Basic Guide

Advanced Guide

1 Camera Basics

2 Auto Mode / Hybrid Auto Mode

3 Other Shooting Modes

4 P Mode

5 Tv, Av, M, and C Modes

6 Playback Mode

7 Wi-Fi Functions

8 Set-Up Menu

9 Accessories

10 Appendix

Index





- Connections require that a memory card with saved images be in the camera.
- Once you have connected to devices via the Wi-Fi menu, recent destinations will be listed first when you access the Wi-Fi menu. You can easily connect again by pressing the [▲][▼] buttons to choose the device and then pressing the [ⓘ] button. To add a new device, display the device selection screen by pressing the [◀][▶] buttons, and then configure the setting.
- Media player connections will be displayed as "MediaServ." in the connection history.
- RAW images and movies are not displayed.
- Information overlay and details displayed on the TV set vary depending on the media player. Depending on the media player, image information may not be displayed, or vertical images may be shown in horizontal orientation.
- Icons with labels such as "1-100" contain images grouped by file number in the selected folder.
- Dates shown for cards or folders may reflect the date on the camera's clock when the card or folder was last viewed.

Printing Images Wirelessly from a Connected Printer

Connect the camera to a printer via Wi-Fi to print as follows. These steps show how to use the camera as an access point, but you can also use an existing access point (📖119).

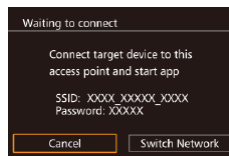
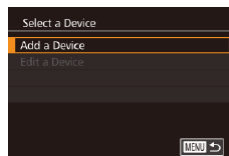

1 Access the Wi-Fi menu.

- Access the Wi-Fi menu as described in step 2 of "Adding a Smartphone Using the Wi-Fi Menu" (📖118).

2 Choose [📄].

- Press the [▲][▼][◀][▶] buttons or turn the [🔘] dial to choose [📄], and then press the [ⓘ] button.

3 Choose [Add a Device].

- Press the [▲][▼] buttons or turn the [🔘] dial to choose [Add a Device], and then press the [ⓘ] button.

- The camera's SSID is displayed.

Before Use

Basic Guide

Advanced Guide

1 Camera Basics

2 Auto Mode / Hybrid Auto Mode

3 Other Shooting Modes

4 P Mode

5 Tv, Av, M, and C Modes

6 Playback Mode

7 Wi-Fi Functions

8 Set-Up Menu

9 Accessories

10 Appendix

Index



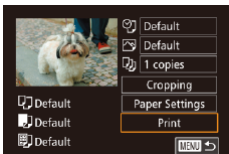
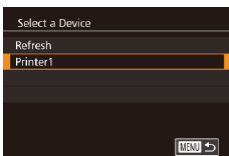

4 Connect the printer to the network.

- In the printer's Wi-Fi setting menu, choose the SSID (network name) displayed on the camera to establish a connection.

5 Choose the printer.

- Choose the printer name (either press the [▲][▼] buttons or turn the [●] dial, and then press the [●] button.

6 Choose an image to print.

- Press the [◀][▶] buttons or turn the [●] dial to choose an image.
- Press the [●] button, choose [Print], and press the [●] button.
- Press the [▲][▼] buttons or turn the [●] dial to choose [Print], and then press the [●] button.
- For detailed printing instructions, see “Printing Images” (160).
- To end the connection, press the [▲] button, choose [OK] on the confirmation screen (either press the [◀][▶] buttons or turn the [●] dial), and then press the [●] button.



- Connections require that a memory card with saved images be in the camera.
- Once you have connected to devices via the Wi-Fi menu, recent destinations will be listed first when you access the Wi-Fi menu. You can easily connect again by pressing the [▲][▼] buttons to choose the device and then pressing the [●] button. To add a new device, display the device selection screen by pressing the [◀][▶] buttons, and then configure the setting.
- If you prefer not to display recent target devices, choose MENU (32) > [4] tab > [Wi-Fi Settings] > [Target History] > [Off].
- To use another access point, follow the steps in “Using Another Access Point” (119).

Before Use

Basic Guide

Advanced Guide

1 Camera Basics

2 Auto Mode / Hybrid Auto Mode

3 Other Shooting Modes

4 P Mode

5 Tv, Av, M, and C Modes

6 Playback Mode

7 Wi-Fi Functions

8 Set-Up Menu

9 Accessories

10 Appendix

Index



Sending Images to Another Camera

Connect two cameras via Wi-Fi and send images between them as follows.

- Only Canon-brand cameras equipped with a Wi-Fi function can be connected to wirelessly. Even Canon-brand cameras that support Eye-Fi cards cannot be connected to if they do not have a Wi-Fi function. You cannot connect to PowerShot SD430 DIGITAL ELPH WIRELESS/ DIGITAL IXUS WIRELESS cameras with this camera.

1 Access the Wi-Fi menu.

- Access the Wi-Fi menu as described in step 2 of “Adding a Smartphone Using the Wi-Fi Menu” (📖118).

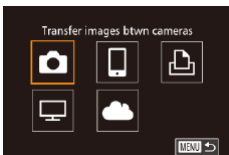

2 Choose [📷].

- Press the [▲][▼][◀][▶] buttons or turn the [🔘] dial to choose [📷], and then press the [📷] button.

3 Choose [Add a Device].

- Press the [▲][▼] buttons or turn the [🔘] dial to choose [Add a Device], and then press the [📷] button.
- Follow steps 1 – 3 on the target camera too.
- Camera connection information will be added when [Start connection on target camera] is displayed on both camera screens.

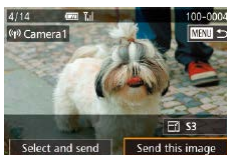
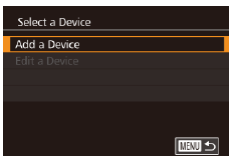

4 Send an image.

- Turn the [🔘] dial to choose an image to send, press the [◀][▶] buttons to choose [Send this image], and then press the [📷] button.
- Image transfer will begin. The screen darkens during image transfer.
- [Transfer completed] is displayed after the image is sent, and the image transfer screen is displayed again.
- To end the connection, press the [MENU] button, choose [OK] on the confirmation screen (either press the [◀][▶] buttons or turn the [🔘] dial), and then press the [📷] button.



- Connections require that a memory card be in the camera.
- Once you have connected to devices via the Wi-Fi menu, recent destinations will be listed first when you access the Wi-Fi menu. You can easily connect again by pressing the [▲][▼] buttons to choose the device and then pressing the [📷] button. To add a new device, display the device selection screen by pressing the [◀][▶] buttons, and then configure the setting.
- If you prefer not to display recent target devices, choose MENU (📖32) > [🔘] tab > [Wi-Fi Settings] > [Target History] > [Off].
- You can also send multiple images at once and change the image size before sending (📖130).

Before Use

Basic Guide

Advanced Guide

1 Camera Basics

2 Auto Mode / Hybrid Auto Mode

3 Other Shooting Modes

4 P Mode

5 Tv, Av, M, and C Modes

6 Playback Mode

7 Wi-Fi Functions

8 Set-Up Menu

9 Accessories

10 Appendix

Index



Image Sending Options

You can choose multiple images to send at once and change the image resolution (size) before sending. Some Web services also enable you to annotate the images you send.

Sending Multiple Images

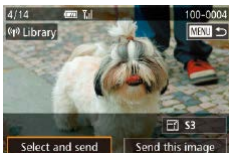

1 Choose [Select and send].

- On the image transfer screen, press the [◀][▶] buttons to choose [Select and send], and then press the [OK] button.

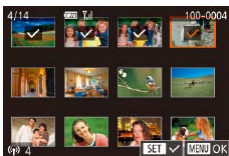

2 Choose images.

- Press the [▲][▼][◀][▶] buttons to choose an image to send, and then press the [OK] button to add a [✓] to the image.
- To cancel selection, press the [OK] button again. [✓] is no longer displayed.
- Repeat this process to choose additional images.
- After you finish choosing images, press the [MENU] button.

3 Send the images.

- Press the [◀][▶] buttons or turn the [DIAL] dial to choose [Send], and then press the [OK] button.



- You can also choose images in step 2 by pressing the [Q] button twice to access single-image display and then pressing the [◀][▶] buttons or turning the [DIAL] dial.

Notes on Sending Images

- Keep your fingers or other objects off the Wi-Fi antenna area (3). Covering this may decrease the speed of your image transfers.
- Depending on the condition of the network you are using, it may take a long time to send movies. Be sure to keep an eye on the camera battery level.
- Up to 50 images can be sent together at once. Only one movie can be sent. However, Web services may limit the number of images or length of movies you can send. For details, refer to the Web service you are using.
- When sending movies to smartphones, note that the supported image quality varies depending on the smartphone. For details, refer to the smartphone user manual.
- On the screen, wireless signal strength is indicated by the following icons:
[Signal strength icons] high, [Signal strength icons] medium, [Signal strength icons] low, [Signal strength icons] weak
- Sending images to Web services will take less time when resending images you have already sent that are still on the CANON IMAGE GATEWAY server.

Before Use

Basic Guide

Advanced Guide

1 Camera Basics

2 Auto Mode / Hybrid Auto Mode

3 Other Shooting Modes

4 P Mode

5 Tv, Av, M, and C Modes

6 Playback Mode

7 Wi-Fi Functions

8 Set-Up Menu

9 Accessories

10 Appendix

Index



Choosing the Number of Recording Pixels (Image Size)

On the image transfer screen, choose [F1] by pressing the [▲][▼] buttons, and then press the [OK] button. On the screen displayed, choose the recording pixel setting (image size) by pressing the [▲][▼] buttons, and then press the [OK] button.

- To send images at original size, select [No] as the resizing option.
- Choosing [S2] or [S3] will resize images that are larger than the selected size before sending.
- Movies cannot be resized.

Adding Comments

Using the camera, you can add comments to images that you send to e-mail addresses, social networking services, etc. The number of characters and symbols that can be entered may differ depending on the Web service.

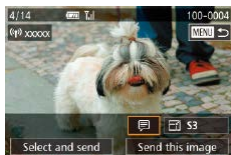

1 Access the screen for adding comments.

- On the image transfer screen, choose [F1] by pressing the [▲][▼][4][▶] buttons, and then press the [OK] button.
- On the image transfer screen, touch [F1].

2 Add a comment (p.33).

3 Send the image.



- When a comment is not entered, the comment set in CANON IMAGE GATEWAY is automatically sent.
- You can also annotate multiple images before sending them. The same comment is added to all images sent together.

Sending Images Automatically (Image Sync)

Images on the memory card that have not been transferred already can be sent to a computer or Web services via CANON IMAGE GATEWAY. Note that images cannot be sent only to Web services.

Initial Preparations

Preparing the Camera

Register [F1] as the destination.



1 Add [F1] as a destination.

- Add [F1] as a destination, as described in “Registering CANON IMAGE GATEWAY” (p.123).
- When also choosing a Web service as a destination for sending images, log in to CANON IMAGE GATEWAY (p.124), then choose your camera model, access the Web service settings screen, and under the Image Sync settings, choose the Web service destination. For details, refer to Help in CANON IMAGE GATEWAY.

2 Choose the type of images to send (only when sending movies with images).

- Press the [MENU] button and choose [Wi-Fi Settings] on the [F4] tab (p.32).
- Press the [▲][▼] buttons to choose [Image Sync], and then choose [Stills/Movies] (p.32).

Before Use

Basic Guide

Advanced Guide

1 Camera Basics

2 Auto Mode / Hybrid Auto Mode

3 Other Shooting Modes

4 P Mode

5 Tv, Av, M, and C Modes

6 Playback Mode

7 Wi-Fi Functions

8 Set-Up Menu

9 Accessories

10 Appendix

Index



Preparing the Computer



Install and configure the software on the destination computer.



1 Install the software.

- Install the software on a computer connected to the Internet (📖158).



2 Register the camera.

- Windows: In the taskbar, right-click , and then click [Add new camera].
- Mac OS: In the menu bar, click , and then click [Add new camera].
- A list of cameras linked to CANON iMAGE GATEWAY is displayed. Choose the camera from which images are to be sent.
- Once the camera is registered and the computer is ready to receive images, the icon changes to .

Sending Images

Images sent from the camera are automatically saved to the computer. If the computer that you intend to send images to is turned off, the images will be stored temporarily on the CANON iMAGE GATEWAY server. Stored images are regularly erased, so make sure to turn on the computer and save the images.

1 Send images.

- Follow steps 1 – 2 in “Uploading Images to Web Services” (📖125) to choose .
- Once the connection is established, the images are sent. When the images have been sent successfully to the CANON iMAGE GATEWAY server,  is displayed on the screen.

2 Save the images to the computer.

- Images are automatically saved to the computer when you turn it on.
-  is displayed in the sent images.



- When sending images, you should use a fully charged battery pack or an AC adapter kit (sold separately, 📖148).



- Even if images were imported to the computer through a different method, any images not yet sent to the computer from CANON iMAGE GATEWAY will be sent to the computer.
- Sending is faster when the destination is a computer on the same network as the camera, because images are sent via the access point instead of CANON iMAGE GATEWAY. Note that images stored on a computer are sent to CANON iMAGE GATEWAY, so the computer must be connected to the Internet.

Before Use

Basic Guide

Advanced Guide

1 Camera Basics

2 Auto Mode / Hybrid Auto Mode

3 Other Shooting Modes

4 P Mode

5 Tv, Av, M, and C Modes

6 Playback Mode

7 Wi-Fi Functions

8 Set-Up Menu

9 Accessories

10 Appendix

Index



Shooting Remotely

As you check a shooting screen on your smartphone, you can use it to shoot remotely.



- Privacy settings must be configured in advance to allow all images (📖116, 📖135).

1 Secure the camera.

- Keep the camera still by mounting it on a tripod or taking other measures.

2 Connect the camera and smartphone (📖116).

- In the privacy settings, choose [All images].

3 Choose remote shooting.

- Choose remote shooting in EOS Remote on the smartphone.
- Once the camera is ready for remote shooting, a live image from the camera will be displayed on the smartphone.
- At this time, a message is displayed on the camera, and all operations except pressing the power button or mode dial are disabled.

4 Shoot.

- Use the smartphone to shoot.



- Movie shooting is not available.
- It may take longer than usual to focus on the subject.
- Depending on the connection status, image display or shot timing may be slower than usual.



- Any jerky subject motion shown on the smartphone due to the connection environment will not affect recorded images.
- Captured images are not transferred to the smartphone. Use the smartphone to browse and import images from the camera.

Before Use

Basic Guide

Advanced Guide

1 Camera Basics

2 Auto Mode / Hybrid Auto Mode

3 Other Shooting Modes

4 P Mode

5 Tv, Av, M, and C Modes

6 Playback Mode

7 Wi-Fi Functions

8 Set-Up Menu

9 Accessories

10 Appendix

Index



Editing or Erasing Wi-Fi Settings

Edit or erase Wi-Fi settings as follows.

Editing Connection Information

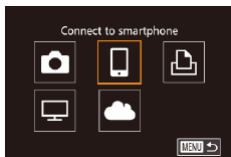

1 Access the Wi-Fi menu and choose a device to edit.

- Press the [▶] button to turn the camera on.
- Press the [▲] button.
- Access the device selection screen (press the [◀][▶] buttons or turn the [🌀] dial), choose the icon of a device to edit (press the [▲][▼][◀][▶] buttons or turn the [🌀] dial), and then press the [📁] button.

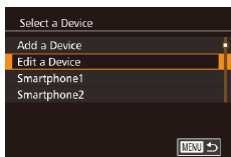

2 Choose [Edit a Device].

- Press the [▲][▼] buttons or turn the [🌀] dial to choose [Edit a Device], and then press the [📁] button.

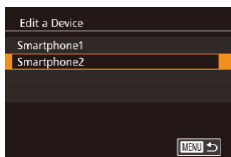

3 Choose the device to edit.

- Press the [▲][▼] buttons or turn the [🌀] dial to choose the device to edit, and then press the [📁] button.

4 Choose the item to edit.

- Press the [▲][▼] buttons or turn the [🌀] dial to choose the item to edit, and then press the [📁] button.
- The items you can change depend on the device or service.

Configurable Items	Connection				
					Web Services
Change Device Nickname (📖134)	○	○	○	–	–
View Settings (📖135)	–	○	–	–	–
Erase Connection Info (📖135)	○	○	○	–	–

○: Configurable –: Not configurable

Changing a Device Nickname

You can change the device nickname (display name) that is displayed on the camera.

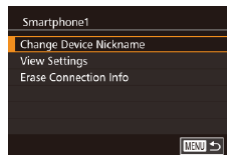

- Following step 4 in “Editing Connection Information” (📖134), choose [Change Device Nickname] and press the [📁] button.
- Select the input field and press the [📁] button. Use the keyboard displayed to enter a new nickname (📖33).

Before Use

Basic Guide

Advanced Guide

1 Camera Basics

2 Auto Mode / Hybrid Auto Mode

3 Other Shooting Modes

4 P Mode

5 Tv, Av, M, and C Modes

6 Playback Mode

7 Wi-Fi Functions

8 Set-Up Menu

9 Accessories

10 Appendix

Index



Erasing Connection Information

Erase connection information (information about devices that you have connected to) as follows.

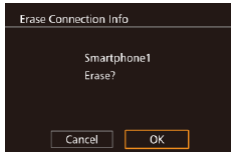

- Following step 4 in “Editing Connection Information” (📖134), choose [Erase Connection Info] and press the [ⓘ] button.
- After [Erase?] is displayed, press the [◀][▶] buttons or turn the [🔘] dial to choose [OK], and then press the [ⓘ] button.
- The connection information will be erased.

Specifying Images to Share with Smartphones

You can change the device nickname (display name) that is displayed on the camera.

Share setting	Images shared with smartphone
All images	All images stored on the card
Images shot today	Images shot on the current day
Images shot in past days	Images shot within a specified previous number of days
Select by rating	Images with the specified rating (📖108)
File number range	Images within the specified range

This setting is also possible whenever the screen in step 2 is displayed during the smartphone connection.

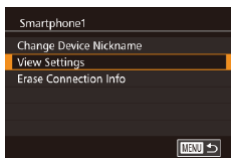

1 Access the setting screen.

- Follow step 4 in “Editing Connection Information” (📖134), choose [View Settings] and then press the [ⓘ] button.

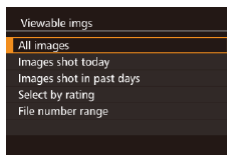

2 Select a share setting.

- Press the [▲][▼] buttons or turn the [🔘] dial to choose a menu item.
- If selecting [All images] or [Images shot today], press the [ⓘ] button.
- If selecting [Images shot in past days], press the [ⓘ] button. In the screen that appears, press the [▲][▼] buttons to select the number of days, and then press the [ⓘ] button.
- If selecting [Select by rating], press the [ⓘ] button. In the screen that appears, press the [▲][▼] buttons to select the rating, and then press the [ⓘ] button.
- If selecting [File number range], press the [ⓘ] button. In the screen that appears, select the beginning and end of the file number range, choose [OK], and then press the [ⓘ] button. Follow steps 2 – 3 in “Selecting a Range” (📖103) to define the range.



- Choose [All images] when shooting remotely.

Before Use

Basic Guide

Advanced Guide

1 Camera Basics

2 Auto Mode / Hybrid Auto Mode

3 Other Shooting Modes

4 P Mode

5 Tv, Av, M, and C Modes

6 Playback Mode

7 Wi-Fi Functions

8 Set-Up Menu

9 Accessories

10 Appendix

Index



Returning the Wi-Fi Settings to Default

Return the Wi-Fi settings to default if you transfer ownership of the camera to another person, or dispose of it. Resetting the Wi-Fi settings will also clear all Web service settings. Be sure that you want to reset all Wi-Fi settings before using this option.

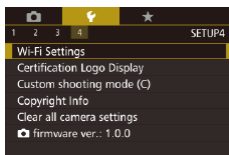

1 Choose [Wi-Fi Settings].

- Press the [MENU] button and choose [Wi-Fi Settings] on the [4] tab (132).

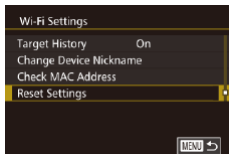

2 Choose [Reset Settings].

- Press the [▲][▼] buttons or turn the [DIAL] dial to choose [Reset Settings], and then press the [OK] button.

3 Restore the default settings.

- Press the [◀][▶] buttons or turn the [DIAL] dial to choose [OK], and then press the [OK] button.
- The Wi-Fi settings are now reset.



- To reset other settings (aside from Wi-Fi) to defaults, choose [Clear all camera settings] on the [4] tab (145).

Before Use

Basic Guide

Advanced Guide

1 Camera Basics

2 Auto Mode / Hybrid Auto Mode

3 Other Shooting Modes

4 P Mode

5 Tv, Av, M, and C Modes

6 Playback Mode

7 Wi-Fi Functions

8 Set-Up Menu

9 Accessories

10 Appendix

Index



8

Set-Up Menu

Customize or adjust basic camera functions for greater convenience

Adjusting Basic Camera Functions

MENU (📖32) functions on the [F1], [F2], [F3] and [F4] tabs can be configured. Customize commonly used functions as desired, for greater convenience.

Date-Based Image Storage

Instead of saving images in folders created each month, you can have the camera create folders each day you shoot to store shots taken that day.

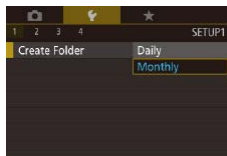

- Choose [Create Folder] on the [F1] tab and then choose [Daily].
- Images will now be saved in folders created on the shooting date.

File Numbering

Your shots are automatically numbered in sequential order (0001–9999) and saved in folders that store up to 2000 images each. You can change how the camera assigns file numbers.

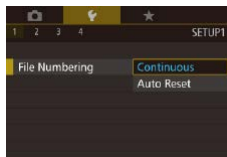

- Choose [File Numbering] on the [F1] tab and then choose an option.

Continuous	Images are numbered consecutively (until the 9999th shot is taken/saved) even if you switch memory cards.
Auto Reset	Image numbering is reset to 0001 if you switch memory cards, or when a new folder is created.

Before Use

Basic Guide

Advanced Guide

1 Camera Basics

2 Auto Mode / Hybrid Auto Mode

3 Other Shooting Modes

4 P Mode

5 Tv, Av, M, and C Modes

6 Playback Mode

7 Wi-Fi Functions

8 Set-Up Menu

9 Accessories

10 Appendix

Index





- Regardless of the option selected in this setting, shots may be numbered consecutively after the last number of existing images on newly inserted memory cards. To start saving shots from 0001, use an empty (or formatted (📖138)) memory card.

Formatting Memory Cards

Before using a new memory card or a card formatted in another device, you should format the card with this camera.

Formatting erases all data on a memory card. Before formatting, copy images on the memory card to a computer, or take other steps to back them up.

1 Access the [Format] screen.

- Choose [Format] on the [📷] tab and then press the [📷] button.

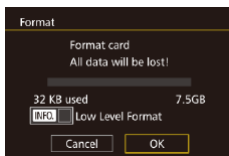

2 Choose [OK].

- Press the [◀][▶] buttons or turn the [📷] dial to choose [OK], and then press the [📷] button.
- The card is now formatted.



- Formatting or erasing data on a memory card only changes file management information on the card and does not erase the data completely. When transferring or disposing of memory cards, take steps to protect personal information if necessary, as by physically destroying cards.



- The total card capacity indicated on the formatting screen may be less than the advertised capacity.

Low-Level Formatting

Perform low-level formatting in the following cases: [Memory card error] is displayed, the camera is not working correctly, card image reading/writing is slower, continuous shooting is slower, or movie recording suddenly stops. Low-level formatting erases all data on a memory card. Before low-level formatting, copy images on the memory card to a computer, or take other steps to back them up.

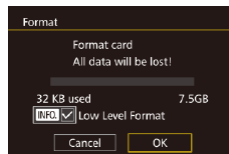

- On the screen in step 2 of “Formatting Memory Cards” (📖138), press the [INFO] button to place a [✓] by [Low Level Format].
- Follow step 2 in “Formatting Memory Cards” (📖138) to continue the formatting process.



- Low-level formatting takes longer than “Formatting Memory Cards” (📖138), because data is erased from all storage regions of the memory card.
- You can cancel low-level formatting in progress by choosing [Cancel]. In this case, all data will be erased, but the memory card can be used normally.

Before Use

Basic Guide

Advanced Guide

1 Camera Basics

2 Auto Mode / Hybrid Auto Mode

3 Other Shooting Modes

4 P Mode

5 Tv, Av, M, and C Modes

6 Playback Mode

7 Wi-Fi Functions

8 Set-Up Menu

9 Accessories

10 Appendix

Index



Changing Video Formats

This lets you define the image format for your TV set. This setting also changes the image quality (frame rate) options available for movies.

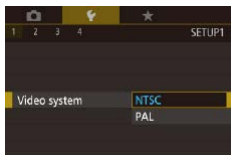

- Choose [Video system] on the [F1] tab and then choose an option.

Electronic Level Calibration

Calibrate the electronic level if it seems ineffective in helping you level the camera.

For greater calibration accuracy, display grid lines (📖30) to help you level the camera in advance.

1 Make sure the camera is level.

- Place the camera on a flat surface, such as a table.

2 Calibrate the electronic level.

- Choose [Electronic Level] on the [F1] tab and then press the [OK] button.
- To adjust left/right tilt, choose [Horizontal Roll Calibration], and to adjust forward/backward tilt, choose [Vertical Pitch Calibration], followed by the [OK] button. A confirmation message is displayed.
- Choose [OK], and then press the [OK] button.

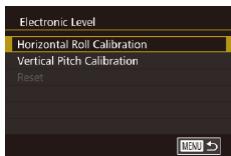

Resetting the Electronic Level

Restore the electronic level to its original state as follows. Note that this is not possible unless you have calibrated the electronic level.

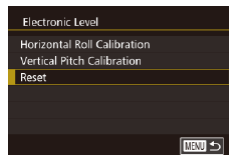

- Choose [Electronic Level] on the [F1] tab and then press the [OK] button.
- Choose [Reset], and press the [OK] button.
- Choose [OK], and then press the [OK] button.

Using Eco Mode

This function allows you to conserve battery power in Shooting mode. When the camera is not in use, the screen quickly darkens to reduce battery consumption.

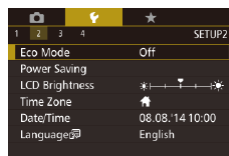

1 Configure the settings.

- Choose [Eco Mode] on the [F2] tab and then choose [On].
- [ECO] is now shown on the shooting screen (📖174).
- The screen darkens when the camera is not used for approximately two seconds; approximately two seconds after darkening, the screen turns off. The camera turns off after approximately three minutes of inactivity.

2 Shoot.

- To activate the screen and prepare for shooting when the screen is off but the (rear) indicator lamp is still on, press the shutter button halfway.

Before Use

Basic Guide

Advanced Guide

1 Camera Basics

2 Auto Mode / Hybrid Auto Mode

3 Other Shooting Modes

4 P Mode

5 Tv, Av, M, and C Modes

6 Playback Mode

7 Wi-Fi Functions

8 Set-Up Menu

9 Accessories

10 Appendix

Index



Power-Saving Adjustment

Adjust the timing of automatic camera and screen deactivation (Auto Power Down and Display Off, respectively) as needed (📖28).

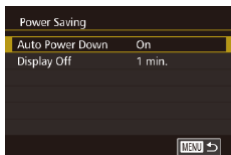

- Choose [Power Saving] on the [F2] tab and then press the [OK] button.
- Select an item and press the [OK] button. Press the [▲][▼] buttons or turn the [DISP.] dial to change the setting and then press [OK] again.



- To conserve battery power, you should normally choose [On] for [Auto Power Down] and [1 min.] or less for [Display Off].



- The [Display Off] setting is applied even if you set [Auto Power Down] to [Off].
- These power-saving functions are not available when you have set Eco Mode (📖139) to [On].

Screen Brightness

Adjust screen brightness as follows.



- Choose [LCD Brightness] on the [F2] tab and press the [OK] button. Choose the speed by pressing the [◀][▶] buttons or turning the [DISP.] dial.



- For maximum brightness, press and hold the [INFO.] button for at least one second when the shooting screen is displayed or when in single-image display. (This will override the [LCD Brightness] setting on the [F2] tab.) To restore the original brightness, press and hold the [INFO.] button again for at least one second or restart the camera.

Before Use

Basic Guide

Advanced Guide

1 Camera Basics

2 Auto Mode / Hybrid Auto Mode

3 Other Shooting Modes

4 P Mode

5 Tv, Av, M, and C Modes

6 Playback Mode

7 Wi-Fi Functions

8 Set-Up Menu

9 Accessories

10 Appendix

Index



World Clock

To ensure that your shots will have the correct local date and time when you travel abroad, simply register the destination in advance and switch to that time zone. This convenient feature eliminates the need to change the Date/Time setting manually.

Before using the world clock, be sure to set the date and time and your home time zone, as described in “Setting the Date and Time” (18).

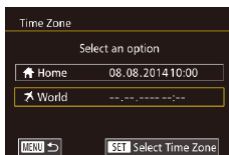

1 Specify your destination.

- Choose [Time Zone] on the [F2] tab and then press the [Globe] button.
- Press the [▲][▼] buttons or turn the [Dial] dial to choose [✈ World], and then press the [Globe] button.
- Press the [◀][▶] buttons to choose the destination.
- To set daylight saving time (1 hour ahead), choose [☀] by pressing the [▲][▼] buttons, and then choose [☀] by pressing the [◀][▶] buttons.
- Press the [Globe] button.

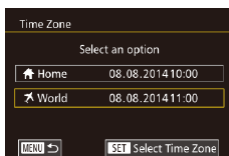

2 Switch to the destination time zone.

- Press the [▲][▼] buttons or turn the [Dial] dial to choose [✈ World], and then press the [MENU] button.
- [✈] is now shown on the shooting screen (174).



- Adjusting the date or time while in [✈] mode (19) will automatically update your [Home] time and date.

Date and Time

Adjust the date and time as follows.

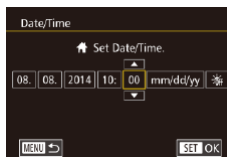

- Choose [Date/Time] on the [F2] tab and then press the [Globe] button.
- Press the [◀][▶] buttons to choose an option, and then adjust the setting, either by pressing the [▲][▼] buttons or turning the [Dial] dial.

Display Language

Change the display language as needed.

English	Norsk	Română
Deutsch	Svenska	Türkçe
Français	Español	العربية
Nederlands	Ελληνικά	മലയാളം
Dansk	Русский	简体中文
Português	Polski	繁體中文
Suomi	Čeština	한국어
Italiano	Magyar	日本語
Українська		SET OK

- Choose [Language] on the [F2] tab and then press the [Globe] button.
- Press the [▲][▼][◀][▶] buttons or turn the [Dial] dial to choose a language, and then press the [Globe] button.



- You can also access the [Language] screen in Playback mode by pressing and holding the [Globe] button and pressing the [MENU] button.

Before Use

Basic Guide

Advanced Guide

1 Camera Basics

2 Auto Mode / Hybrid Auto Mode

3 Other Shooting Modes

4 P Mode

5 Tv, Av, M, and C Modes

6 Playback Mode

7 Wi-Fi Functions

8 Set-Up Menu

9 Accessories

10 Appendix

Index



Silencing Camera Operations

The camera can be silenced when you press the shutter button halfway or trigger the self-timer.

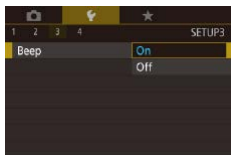

- Choose [Beep] on the [F3] tab and then choose [Off].

Hiding Hints and Tips

Hints and tips are normally shown when you choose an option in the quick setting menu (p.31) or shooting functions screen (p.61). If you prefer, you can deactivate this information.

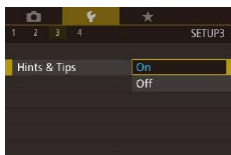

- Choose [Hints & Tips] on the [F3] tab and then choose [Off].

Changing Touch Screen Settings

The sensitivity of the touch screen can be changed to respond to a lighter touch, or not respond to touch at all.

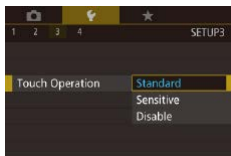

- Choose [Touch Operation] on the [F3] tab and then choose the desired setting.
- Choose [Sensitive] to boost touch screen sensitivity, or choose [Disable] to turn touch screen control off.



- Note the following precautions when operating the touch screen.
 - Since the LCD monitor is not pressure-sensitive, do not use any sharp objects such as your fingernail or a ballpoint pen, for touch operations.
 - Do not use wet fingers for touch screen operations.
 - If the LCD monitor has any moisture or if your fingers are wet, the touch screen may not respond or incorrect operation may occur. In such a case, turn off the power and wipe the LCD monitor with a cloth.
 - Do not attach any protective sheet (commercially available) or sticker on the LCD monitor. Doing so may reduce touch screen responsiveness.
- The touch screen may not be as responsive in [Sensitive] mode when performing successive touch operations.

Cleaning the Image Sensor

The camera has a cleaning function that automatically removes dust from the image sensor when the power is turned on or off, or when the camera shuts off in Power Saving mode. This cleaning function can be activated whenever you like, or shut off entirely.

Turning Auto Cleaning Off

1 Access the setting screen.

- After turning the camera on in shooting mode, choose [Sensor cleaning] on the [F3] tab and press the [OK] button.
- Press the [▲][▼] buttons or turn the [DISP] dial to choose [Auto cleaning .□.], and then press the [OK] button.

Before Use

Basic Guide

Advanced Guide

1 Camera Basics

2 Auto Mode / Hybrid Auto Mode

3 Other Shooting Modes

4 P Mode

5 Tv, Av, M, and C Modes

6 Playback Mode

7 Wi-Fi Functions

8 Set-Up Menu

9 Accessories

10 Appendix

Index



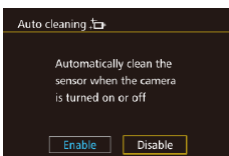

2 Configure the settings.

- Press the [◀][▶] buttons or turn the [Q] dial to choose [Disable], and then press the [Q] button.

Activating the Cleaner

1 Access the setting screen.

- After turning the camera on in shooting mode, choose [Sensor cleaning] on the [P/3] tab and press the [Q] button.
- Press the [▲][▼] buttons or turn the [Q] dial to choose [Clean now], and then press the [Q] button.

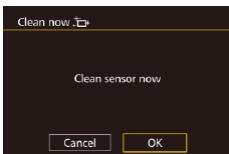

2 Clean the sensor.

- Press the [◀][▶] buttons or turn the [Q] dial to choose [OK], and then press the [Q] button.
- The screen will indicate that the sensor is being cleaned. Although there will be a shutter sound, a picture is not taken.



- The sensor cleaning also works while no lens is attached. If no lens is attached, do not insert your finger or blower tip beyond the lens mount. This is to prevent damage to the shutter curtains.



- For the most effective cleaning results, place the camera upright on a desk or other surface before cleaning.
- Repeated consecutive sensor cleanings will not produce notably better results. [Clean now] may not be available for selection immediately after cleaning.
- If there is dust or any other material on the image sensor that the cleaning function cannot remove, contact a Canon Customer Support Help Desk.

Cleaning Manually

If there is dust or dirt on the image sensor that the cleaner cannot remove, try to clean it manually using a commercial blower or other device. The image sensor is an extremely delicate component. If manual cleaning is required, consulting with the Canon Service Center (listed in the appendix) is strongly recommended.

1 Turn the camera off.

2 Detach the lens.

3 Clean the image sensor.



- The image sensor is an extremely delicate component. Exercise care when cleaning.
- Do not use a blower equipped with a brush. Brushes can damage the image sensor upon contact.
- Do not insert the blower into the lens mount surface. This can damage the shutter.
- Do not clean with high-pressure air or gas. High-pressure airflow can damage the image sensor, and condensing or freezing gas can damage the image sensor surface.
- If the blower still fails to clean the image sensor, having the sensor cleaned by a Canon Service Center is recommended.

Before Use

Basic Guide

Advanced Guide

1 Camera Basics

2 Auto Mode / Hybrid Auto Mode

3 Other Shooting Modes

4 P Mode

5 Tv, Av, M, and C Modes

6 Playback Mode

7 Wi-Fi Functions

8 Set-Up Menu

9 Accessories

10 Appendix

Index



Checking Certification Logos

Some logos for certification requirements met by the camera can be viewed on the screen. Other certification logos are printed in this guide, on the camera packaging, or on the camera body.



- Choose [Certification Logo Display] on the [4] tab and then press the [INFO] button.

Setting Copyright Information to Record in Images

To record the author's name and copyright details in images, set this information beforehand as follows.

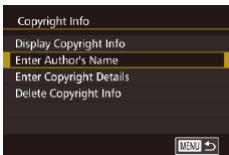

- Choose [Copyright Info] on the [4] tab and then press the [INFO] button.
- Press the [▲][▼] buttons or turn the [DISP.] dial to choose [Enter Author's Name] or [Enter Copyright Details]. Press the [INFO] button to access the keyboard, and enter the name (133).
- Press the [MENU] button, and [Accept changes?] is displayed. Press the [◀][▶] buttons or turn the [DISP.] dial to choose [Yes], and then press the [INFO] button.
- The information set here will now be recorded in images.



- To check the information entered, choose [Display Copyright Info] on the screen above, and then press the [INFO] button.
- You can also use the EOS Utility software (158) to enter, change, and delete copyright information. Some characters entered with the software may not display on the camera, but will be correctly recorded in images.
- You can check copyright information recorded in images using the software once you save the images to a computer.

Deleting All Copyright Information

You can delete both the author's name and copyright details at the same time as follows.

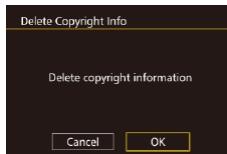

- Follow the steps in “Setting Copyright Information to Record in Images” (144) and choose [Delete Copyright Info].
- Press the [◀][▶] buttons or turn the [DISP.] dial to choose [OK], and then press the [INFO] button.



- The copyright info already recorded in images will not be deleted.

Before Use

Basic Guide

Advanced Guide

1 Camera Basics

2 Auto Mode / Hybrid Auto Mode

3 Other Shooting Modes

4 P Mode

5 Tv, Av, M, and C Modes

6 Playback Mode

7 Wi-Fi Functions

8 Set-Up Menu

9 Accessories

10 Appendix

Index



Adjusting Other Settings

The following functions are also available for use.

- [Wi-Fi Settings] ([F4] tab) (📖115)
- [Custom shooting mode (C)] ([F4] tab) (📖90)
- [📷 firmware ver.: *.*] ([F4] tab) (used for updating the firmware)



- During firmware updates, the touch screen will be disabled to prevent accidental operations.

Restoring Defaults

If you accidentally change a setting, you can restore default camera settings.

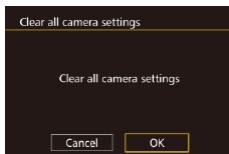

1 Access the [Clear all camera settings] screen.

- Choose [Clear all camera settings] on the [F4] tab and then press the [📷] button.

2 Restore default settings.

- Press the [◀][▶] buttons or turn the [📷] dial to choose [OK], and then press the [📷] button.
- Default settings are now restored.



- The following functions are not restored to default settings.
 - [Video system] on the [F1] tab (📖139)
 - [Time Zone] (📖141), [Date/Time] (📖141), and [Language] (📖141) on the [F2] tab
 - [External flash func. setting] or [External flash C.Fn setting] in [Flash Control] on the [F3] tab
 - The [📷] tab
 - Exposure compensation (📖61) settings
 - Shooting mode (📖51)
 - Wi-Fi settings (📖115)
 - Calibrated value for the electronic level (📖139)
 - Copyright information (📖144)

Before Use

Basic Guide

Advanced Guide

1 Camera Basics

2 Auto Mode / Hybrid Auto Mode

3 Other Shooting Modes

4 P Mode

5 Tv, Av, M, and C Modes

6 Playback Mode

7 Wi-Fi Functions

8 Set-Up Menu

9 Accessories

10 Appendix

Index



9

Accessories

Enjoy the camera in more ways with optional Canon accessories and other compatible accessories sold separately

Use of genuine Canon accessories is recommended.

This product is designed to achieve excellent performance when used with genuine Canon accessories. Canon shall not be liable for any damage to this product and/or accidents such as fire, etc., caused by the malfunction of non-genuine Canon accessories (e.g., a leakage and/or explosion of a battery pack). Please note that this warranty does not apply to repairs arising out of the malfunction of non-genuine Canon accessories, although you may request such repairs on a chargeable basis.

Before Use

Basic Guide

Advanced Guide

1 Camera Basics

2 Auto Mode / Hybrid Auto Mode

3 Other Shooting Modes

4 P Mode

5 Tv, Av, M, and C Modes

6 Playback Mode

7 Wi-Fi Functions

8 Set-Up Menu

9 Accessories

10 Appendix

Index



System Map

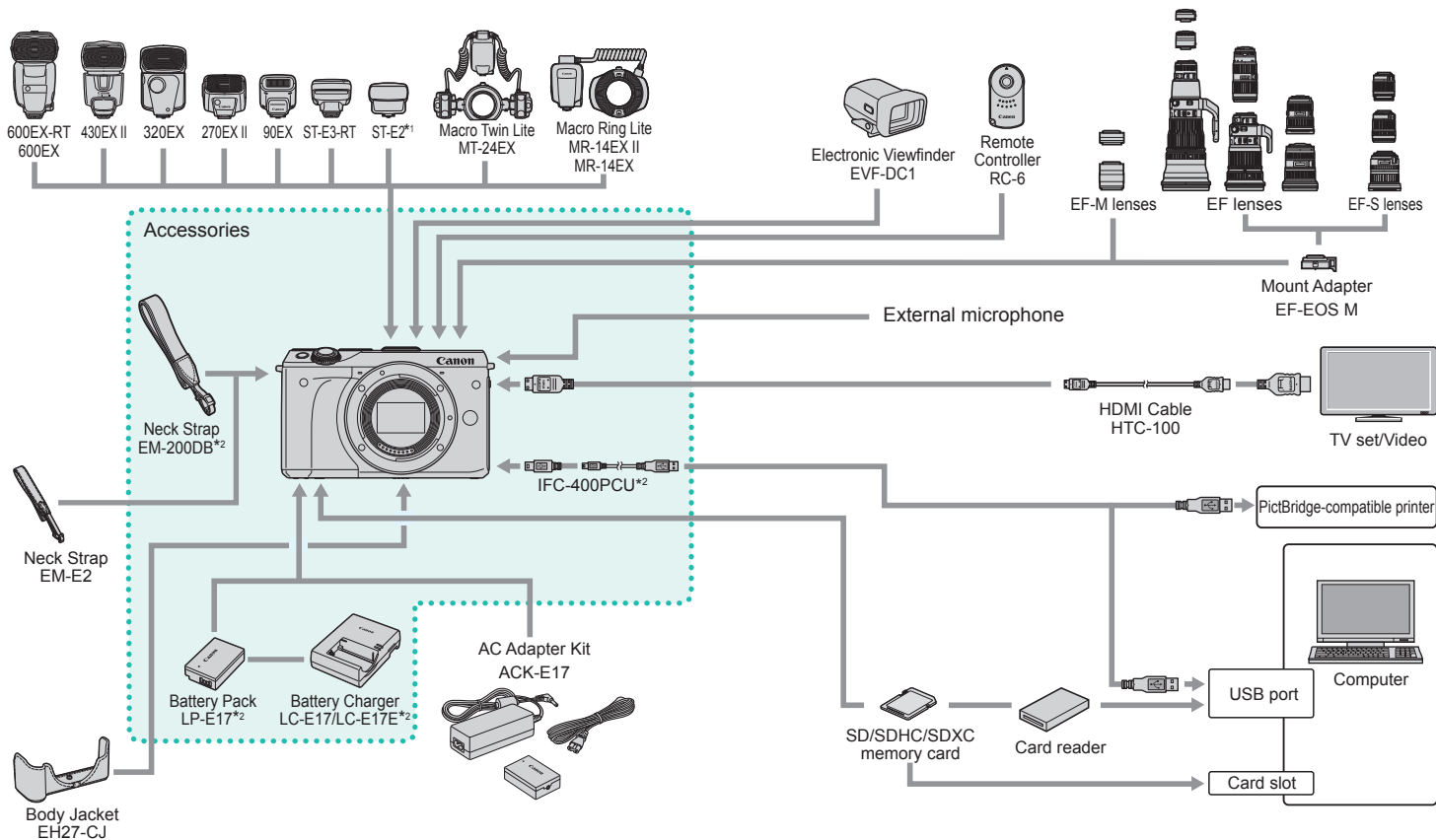

Before Use

Basic Guide

Advanced Guide

1 Camera Basics

2 Auto Mode / Hybrid Auto Mode

3 Other Shooting Modes

4 P Mode

5 Tv, Av, M, and C Modes

6 Playback Mode

7 Wi-Fi Functions

8 Set-Up Menu

9 Accessories

10 Appendix

Index

*1 Depending on the lens attached, use of the Off-Camera Shoe Cord OC-E3 (sold separately) may be necessary.

*2 Also available for purchase separately.



Optional Accessories

The following camera accessories are sold separately. Note that availability varies by area, and some accessories may no longer be available.

Lens

EF-M lenses, EF lenses, EF-S lenses

- Pick from a variety of lenses to support whatever target or expression you want. The Mount Adapter EF-EOS M is required to attach EF and EF-S lenses.

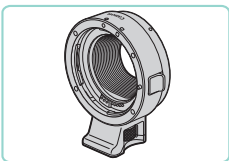

Mount Adapter EF-EOS M

- Use this mounting adapter to attach EF or EF-S lenses to your camera.

Power Supplies

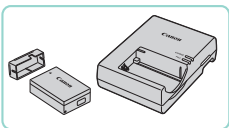

Battery Pack LP-E17

- Rechargeable lithium-ion battery.

Battery Charger LC-E17/LC-E17E

- Charger for Battery Pack LP-E17



- The message [Battery communication error] is displayed if you use a non-genuine Canon battery pack, and user response is required. Note that Canon shall not be liable for any damages resulting from accidents, such as malfunction or fire, that occur due to use of non-genuine Canon battery packs.



- The battery pack includes a convenient cover which you can attach so that ▲ is visible on a charged battery pack, and attach it so that ▲ is not visible on an uncharged battery pack.

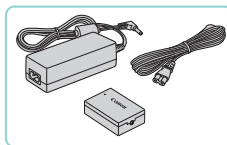

AC Adapter Kit ACK-E17

- For powering the camera using household power. Recommended when using the camera over extended periods, or when connecting the camera to a printer or computer. Cannot be used to charge the battery pack in the camera.



- The battery charger and AC adapter kit can be used in areas with 100 – 240 V AC power (50/60 Hz).
- For power outlets in a different format, use a commercially available adapter for the plug. Never use an electrical transformer designed for traveling, which may damage the battery pack.

Before Use

Basic Guide

Advanced Guide

1 Camera Basics

2 Auto Mode / Hybrid Auto Mode

3 Other Shooting Modes

4 P Mode

5 Tv, Av, M, and C Modes

6 Playback Mode

7 Wi-Fi Functions

8 Set-Up Menu

9 Accessories

10 Appendix

Index



Flash



Speedlite 600EX-RT/600EX/430EX II/ 320EX/270EX II/90EX

- Shoe-mounted flash unit that enables many styles of flash photography. Speedlite 580EX II, 580EX, 550EX, 430EX, 420EX, 380EX, 270EX, and 220EX are also supported.



Speedlite Transmitter ST-E3-RT/ST-E2

- Enables wireless control of slave Speedlite flash units (except Speedlite 220EX/270EX).
- Off-Camera Shoe Cord OC-E3 may be required when using ST-E2 with certain lenses.

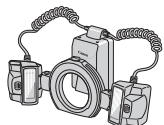

Macro Twin Lite MT-24EX Macro Ring Lite MR-14EX II/MR-14EX

- External macro flash unit that enables many styles of macro flash photography.

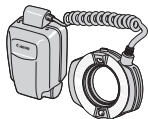

Off-Camera Shoe Cord OC-E3

- Connection cord for using Speedlite away from camera.

Other Accessories

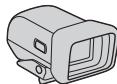

Electronic Viewfinder EVF-DC1

- Makes it easier to get the shot you're looking for.



Remote Controller RC-6

- Enables you to fire a fixed camera from a distance.

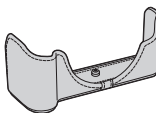

Body Jacket EH27-CJ

- Protects the camera from dust and scratches.



Neck Strap EM-E2

- Strap made from the same material as Body Jacket EH27-CJ.

Before Use

Basic Guide

Advanced Guide

1 Camera Basics

2 Auto Mode /
Hybrid Auto Mode

3 Other Shooting Modes

4 P Mode

5 Tv, Av, M, and C Modes

6 Playback Mode

7 Wi-Fi Functions

8 Set-Up Menu

9 Accessories

10 Appendix

Index



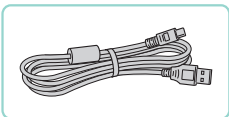

Interface Cable IFC-400PCU

- For connecting the camera to a computer or printer.
- IFC-200U and IFC-500U are also compatible.

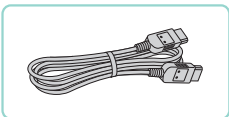

HDMI Cable HTC-100

- For connecting the camera to an HDMI input of a high-definition TV.

Printers

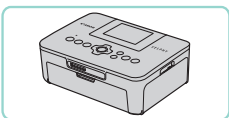

Canon-Brand PictBridge-Compatible Printers

- Even without using a computer, you can print images by connecting the camera directly to a printer. For details, visit your nearest Canon retailer.

Using Optional Accessories

▶ Still Images ▶ Movies

Playback on a TV

▶ Still Images ▶ Movies

Connecting the camera to an HDTV with the HDMI Cable HTC-100 (sold separately) enables you to view your shots on the larger screen of the TV. Movies shot at an image quality of [FHD 29.97P], [FHD 23.98P], [HD 59.94P], [FHD 25.00P], or [HD 50.00P] can be viewed in high definition.

For details on connection or how to switch inputs, refer to the TV manual.

1 Make sure the camera and TV are off.

2 Connect the camera to the TV.

- On the TV, insert the cable plug fully into the HDMI input as shown.

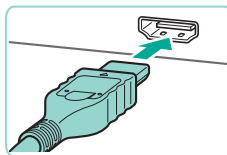

- On the camera, open the terminal cover and insert the cable plug fully into the camera terminal.

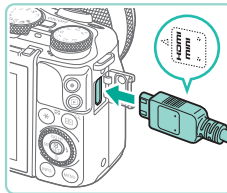

Before Use

Basic Guide

Advanced Guide

1 Camera Basics

2 Auto Mode / Hybrid Auto Mode

3 Other Shooting Modes

4 P Mode

5 Tv, Av, M, and C Modes

6 Playback Mode

7 Wi-Fi Functions

8 Set-Up Menu

9 Accessories

10 Appendix

Index



3 Turn the TV on and switch to external input.

- Switch the TV input to the external input you connected the cable to in step 2.

4 Turn the camera on.

- Press the [▶] button to turn the camera on.
- Images from the camera are now displayed on the TV. (Nothing is displayed on the camera screen.)
- When finished, turn off the camera and TV before disconnecting the cable.



- Touch-screen operations are not supported while the camera is connected to a television.



- When the camera and TV are connected, you can also shoot while previewing shots on the larger screen of the TV. To shoot, follow the same steps as when using the camera screen. However, magnifying images (📖100) is not available.

Powering the Camera with Household Power

▶ Still Images ▶ Movies

Powering the camera with AC Adapter Kit ACK-E17 (sold separately) eliminates the need to monitor the remaining battery level.

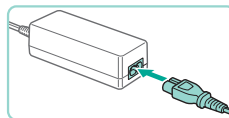
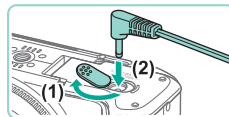
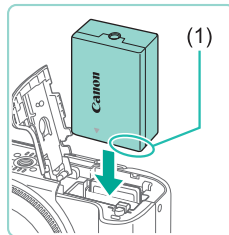

1 Make sure the camera is off.

2 Insert the coupler.

- Follow step 1 in “Inserting the Battery Pack and Memory Card” (📖17) to open the cover.
- Holding the coupler with the terminals (1) facing as shown, insert the coupler just as you would a battery pack (following step 2 in “Inserting the Battery Pack and Memory Card” (📖17)).
- Follow step 4 in “Inserting the Battery Pack and Memory Card” (📖18) to close the cover.

3 Connect the adapter to the coupler.

- Open the cover and insert the adapter plug fully into the coupler.

4 Connect the power cord.

- Insert one end of the power cord into the compact power adapter, and then plug the other end into a power outlet.
- Turn the camera on and use it as desired.
- When finished, turn the camera off and unplug the power cord from the outlet.

Before Use

Basic Guide

Advanced Guide

1 Camera Basics

2 Auto Mode / Hybrid Auto Mode

3 Other Shooting Modes

4 P Mode

5 Tv, Av, M, and C Modes

6 Playback Mode

7 Wi-Fi Functions

8 Set-Up Menu

9 Accessories

10 Appendix

Index





- Do not disconnect the adapter or unplug the power cord while the camera is still on. This may erase your shots or damage the camera.
- Do not attach the adapter or adapter cord to other objects. Doing so could result in malfunction or damage to the product.

Remote Control Shooting

Use Remote Controller RC-6 (sold separately) to shoot pictures up to approx. 5 meters (16 ft.) from the front of the camera.

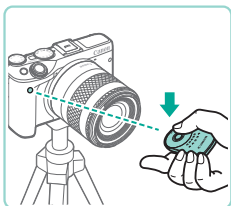

- Follow step 1 in “Using the Self-Timer” (📖40) and choose [📷].
- Point the Remote Controller toward the camera’s remote control sensor and press the transmit button to shoot.



- The picture is not taken until focus is achieved.
- Fluorescent or LED lighting may cause incorrect operation of the camera by triggering the shutter inadvertently. Try to keep the camera away from such light sources.
- If you point a remote controller for a TV set toward the camera and operate it, it may cause incorrect operation of the camera by triggering the shutter inadvertently.



- The Remote Controller can also be used for shooting movies (📖58).

Using the Hot Shoe

The hot shoe is used to attach electronic viewfinders and external flashes (sold separately).

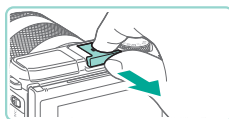

1 Remove the hot shoe cap.

- Pull the cap out in the direction of the arrow.
- To avoid losing the cap, place it in the case for your electronic viewfinder or external flash.



2 Attach the hot shoe cap.

- After removing the external flash or viewfinder, reattach the cap to protect the hot shoe.
- Insert the cap in the direction of the arrow.



- Do not raise the internal flash when an accessory besides the Electronic Viewfinder EVF-DC1 is attached to the hot shoe. The flash may strike the accessory. The flash will not fire at this time.



- Do not open the LCD monitor upward when an accessory like an electronic viewfinder or external flash is attached to the hot shoe. The monitor may strike the viewfinder or flash.

Before Use

Basic Guide

Advanced Guide

1 Camera Basics

2 Auto Mode / Hybrid Auto Mode

3 Other Shooting Modes

4 P Mode

5 Tv, Av, M, and C Modes

6 Playback Mode

7 Wi-Fi Functions

8 Set-Up Menu

9 Accessories

10 Appendix

Index



Using Electronic Viewfinders (Sold Separately)

► Still Images ► Movies

Use an electronic viewfinder (sold separately) to keep closer track of your subject and make it easier to shoot.

When using an electronic viewfinder, shooting time and number of pictures are reduced compared to using the camera's rear screen (LCD monitor).

1 Make sure the camera is off.



2 Attach the electronic viewfinder to the hot shoe.

- Remove the cover of the electronic viewfinder.
- Insert the electronic viewfinder into the hot shoe (152) in the direction shown until it clicks into place.

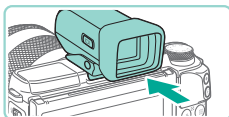

3 Adjust the angle of the electronic viewfinder.

- Adjust the angle of the electronic viewfinder by up to approximately 90 degrees, as needed for your scene or target.

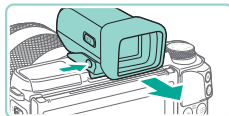
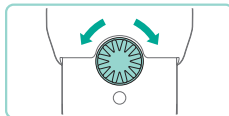
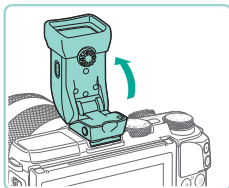

4 Turn on the camera and switch to the camera or electronic viewfinder display.

- Bring your eye up to the electronic viewfinder, and the camera's screen will shut off.
- Remove your eye, and the camera will shut off the finder display and turn the camera screen back on.

5 Adjust the view.

- Turn the dial until you can see the display of the electronic viewfinder clearly.

6 Remove from the camera.

- Once you are done, turn off the camera and hold down the [UNLOCK] button of the electronic viewfinder as you remove it.
- Remove the electronic viewfinder from the camera and store in a safe place when not in use.



- The electronic viewfinder and camera screen displays cannot be active at the same time.
- Camera touch screen control is not available in electronic viewfinder display mode.

Before Use

Basic Guide

Advanced Guide

1 Camera Basics

2 Auto Mode / Hybrid Auto Mode

3 Other Shooting Modes

4 P Mode

5 Tv, Av, M, and C Modes

6 Playback Mode

7 Wi-Fi Functions

8 Set-Up Menu

9 Accessories

10 Appendix

Index





- Although the electronic viewfinder is produced under extremely high-precision manufacturing conditions and more than 99.99% of the pixels meet design specifications, in rare cases some pixels may be defective or may appear as red or black dots. This is not a malfunction. They do not affect the images recorded.
- Vertical or horizontal black bars may be displayed depending on the selected aspect ratio (p.45). The black bars indicate image areas not recorded.
- Press the button on the electronic viewfinder to change the screen displayed.
- In the menu (p.32), set the [Display Control] option on the tab to [Manual] to keep the camera screen from turning on even when you remove your eye from the viewfinder. Press the button on the electronic viewfinder to bring up the camera display in this mode.
- Using the electronic viewfinder in , **P**, **Av**, **Tv**, and **M** modes will result in a smoother display in both the viewfinder and camera screen. In the menu (p.32), set the [Display Mode] option on the tab to [Power Saving] to return to the normal display and conserve battery power.
- If the Wi-Fi (p.115) or keyboard screen (p.33) displays are brought up in electronic viewfinder mode, the display will switch back to the camera screen.
- Different brightness settings (p.140) can be defined for the electronic viewfinder and camera screens.

Using an External Flash (Sold Separately)

► Still Images ► Movies

More sophisticated flash photography is possible with an optional Speedlite EX series flash. For movie shooting using an LED light, the optional Speedlite 320EX flash is available.



- Non-EX series Canon flash units may not fire correctly or may not fire at all, in some cases.
- Use of non-Canon flash units (especially high-voltage flash units) or flash accessories may prevent normal camera operation and may damage the camera.



- Also refer to the Speedlite EX series manual for additional information. This camera is a Type-A camera that can use all the features of EXseries Speedlites.

1 Attach the flash.

- Make sure the camera is off before attaching the flash.

2 Turn the flash on, and then turn the camera on.

- An orange icon is now displayed.
- The flash pilot lamp will light up when the flash is ready.

Before Use

Basic Guide

Advanced Guide

1 Camera Basics

2 Auto Mode / Hybrid Auto Mode

3 Other Shooting Modes

4 P Mode

5 Tv, Av, M, and C Modes

6 Playback Mode

7 Wi-Fi Functions

8 Set-Up Menu

9 Accessories

10 Appendix

Index



3 Choose shooting mode [P], [Tv], [Av], or [M].

- Flash settings can only be configured in these modes. In other modes, the flash is adjusted and fired automatically as needed.

4 Configure the external flash. (book 155)



- Keep cords (from the macro ring lite or macro twin lite, as well as the off-camera shoe cord) away from flash heads.
- When using a tripod, adjust the position of the legs to prevent the flash heads from coming into contact with the legs.
- Depending on the position where you have attached the flash controller, it may come into contact with the LCD monitor. To prevent this, adjust the position of attachment or the orientation of the controller, or adjust the angle of the monitor.



- Settings for the built-in flash cannot be configured while a Speedlite EX series flash is attached, because that setting screen is no longer accessible.
- You can also access the setting screen by pressing the [] button for at least one second.
- 320EX only: Auto LED lighting is only available in low-light movie recording or in Movie mode. In this case, the [] icon is shown.
- The AF-assist beam on the external flash will not fire. If using Speedlite 320EX (sold separately), the LED light may turn on to serve as an AF-assist beam.

Setting External Flash Functions

When an external flash is attached, go to [Flash Control] on the [] tab of the menu (book 32) to adjust the following settings:

- Flash Firing (book 75)
- E-TTL II Metering (book 77)
- Red-eye Reduction (book 47)
- External Flash Function Settings (book 155)
- External Flash Custom Function Settings (book 156)
- Reset (book 157)

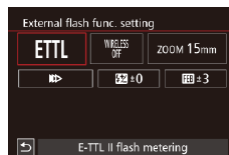

- Choose [External flash func. setting], and press the [] button to display the screen on the left.
- Press the [][][][] buttons to choose an option and press the [] button or turn the [] dial. On the next screen, press the [][][] buttons or turn the [] dial to choose a setting, and then press the [] button to adjust it.

Option	Description
Flash Mode	<p>You can select the flash mode to suit your desired flash shooting.</p> <ul style="list-style-type: none"> [E-TTL II flash metering] is the standard mode of EX-series Speedlites for automatic flash shooting. The [Manual flash] mode is for setting the Speedlite's [Flash output level] yourself. For information on other flash modes, refer to a compatible Speedlite's instruction manual.
Wireless Func.	<p>Wireless (multiple) flash shooting is available. When shooting with multiple flashes, you can also set up the radio channel, optical channel, and master flash firing. For details on wireless flash, refer to the instruction manual of the Speedlite compatible with wireless flash.</p>

Before Use

Basic Guide

Advanced Guide

1 Camera Basics

2 Auto Mode / Hybrid Auto Mode

3 Other Shooting Modes

4 P Mode

5 Tv, Av, M, and C Modes

6 Playback Mode

7 Wi-Fi Functions

8 Set-Up Menu

9 Accessories

10 Appendix

Index



Option	Description
Flash zoom (Flash coverage)	With Speedlites that have a zooming flash head, you can set the flash coverage. Normally, set this to [AUTO] so that the camera will automatically set the flash coverage to match the lens focal length.
Shutter synchronization	Change the timing of the flash and shutter release as follows. <ul style="list-style-type: none"> • [Z] will fire the flash immediately after the shutter opens. • [Z] will fire the flash immediately before the second curtain closes. If the shutter speed is 1/100 second or faster, first-curtain synchronization will be used automatically even if [Second-curtain synchronization] is set. • [Z] allows you to use the flash at all shutter speeds. This is especially effective for portraits using fill flash when you want to give priority to the aperture setting.
Flash Exp. Comp	This allows you to adjust exposure compensation when the flash fires. For details, refer to the instruction manual for the flash. If flash exposure compensation is defined on the Speedlite, you cannot set it on the camera side. If it is defined on both the camera and flash, the flash's setting overrides the camera's.
Flash output level	Define the power output of the flash. For details, refer to the instruction manual for the flash. If it is defined on both the camera and flash, the flash setting overrides the camera setting.
Flash exposure bracketing	Activates FEB (Flash Exposure Bracketing), taking three shots while automatically changing the flash output. For details, refer to the instruction manual of your FEB-compatible flash.
Flash count, Flash frequency	Defines the flash count and frequency when [Flash Mode] is set to [MULTI].

Option	Description
Ratio control	Define the flash output level when using wireless (multi-flash) shooting or the MR-14EX II.



- The [Built-in flash settings] screen cannot be accessed when an external flash is attached.
- On the screen, the settable functions and the display will differ depending on the Speedlite, current flash mode, flash Custom Function settings, etc. For details on your Speedlite's flash functions, refer to the instruction manual of the Speedlite (sold separately).
- With an EX-series Speedlite not compatible with flash function settings, only [Flash Exp. Comp] can be adjusted. ([Shutter synchronization] can also be set with certain EX-series Speedlites.)

Setting External Flash Custom Functions

For details on the Speedlite's Custom Functions, refer to the instruction manual of the Speedlite (sold separately).

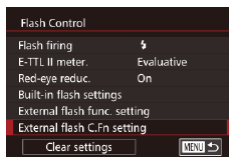

- Press the [MENU] button, select [External flash C.Fn setting] (within [Flash Control] on the [INFO] tab), and then press the [OK] button.
- Press the [LEFT] [RIGHT] buttons or turn the [DIAL] dial to select an option, and then press the [OK] button. On the next screen, press the [UP] [DOWN] buttons or turn the [DIAL] dial to choose a setting, and then press the [OK] button to adjust it.



- Set [Flash metering mode] to [1:TTL] (automatic flash metering) in [External flash C.Fn setting] to fully fire the flash when shooting.

Before Use

Basic Guide

Advanced Guide

1 Camera Basics

2 Auto Mode / Hybrid Auto Mode

3 Other Shooting Modes

4 P Mode

5 Tv, Av, M, and C Modes

6 Playback Mode

7 Wi-Fi Functions

8 Set-Up Menu

9 Accessories

10 Appendix

Index



Resetting External Flash Functions

You can reset the options in the [External flash func. setting] and [External flash C.Fn setting] screens to their defaults.

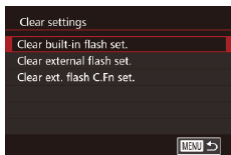

- Press the [MENU] button, select [Clear settings] (within [Flash Control] on the [CAMERA] tab), and press the [OK] button.
- Press the [▲][▼] buttons, or turn the [DISP.] dial to select an option, and then press the [OK] button. On the next screen, press the [◀][▶] buttons, or turn the [DISP.] dial to choose [OK], and then press the [OK] button.



- [Clear built-in flash set.] cannot be accessed when an external flash is attached.

Using External Microphones

▶ Still Images ▶ Movies

Connect a commercially available microphone equipped with a mini plug (3.5 mm diameter) to the camera's external microphone IN terminal (CAMERA). Sound will be recorded with the external microphone. The internal microphones will not be used when an external microphone is connected.

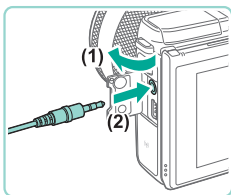

- Open the cover and connect the external microphone.



- Settings will apply to external microphones as well when the attenuator is enabled (p. 59).
- When using an external microphone, [Wind Filter] (p. 59) is always set to [Off].

Before Use

Basic Guide

Advanced Guide

1 Camera Basics

2 Auto Mode / Hybrid Auto Mode

3 Other Shooting Modes

4 P Mode

5 Tv, Av, M, and C Modes

6 Playback Mode

7 Wi-Fi Functions

8 Set-Up Menu

9 Accessories

10 Appendix

Index



Using the Software

The software available for download from the Canon website is introduced below, with instructions for installation and saving images to a computer.

Software

After downloading the software from the Canon website and installing it, you can do the following things on your computer.

- EOS Utility
 - Import images and change camera settings
- Digital Photo Professional
 - Browse, process and edit RAW images
- Picture Style Editor
 - Edit Picture Styles and create and save original Picture Style files
- Image Transfer Utility
 - Set up Image Sync (📖131) and receive images



- To view or edit movies on your computer, use software that supports the movies shot with your camera (i.e. software installed as standard on your computer or software that is generally available).

Software Instruction Manual

Download software instruction manuals from the Canon website.



- Using a computer connected to the Internet, go to “<http://www.canon.com/icpd/>”.
- Access the site for your country or region.

Checking Your Computer Environment

The software can be used on the following computers. For detailed system requirements and compatibility information, including support in new operating systems, visit the Canon website.

Operating System	Windows	Mac OS
	Windows 8/8.1 Windows 7 SP1	Mac OS X 10.9 Mac OS X 10.8



- Check the Canon website for the latest system requirements, including supported OS versions.

Installing the Software

1 Download the software.

- Using a computer connected to the Internet, go to “<http://www.canon.com/icpd/>”.
- Access the site for your country or region.
- Download the software.

2 Click on [Easy Installation] and follow the on-screen instructions.

- Double-click on the downloaded file, and then click on [Easy Installation].
- Follow the on-screen instructions to complete the installation process.
- Installation may take some time, depending on computer performance and the Internet connection.
- Click [Finish] or [Restart] on the screen after installation.

Before Use

Basic Guide

Advanced Guide

1 Camera Basics

2 Auto Mode / Hybrid Auto Mode

3 Other Shooting Modes

4 P Mode

5 Tv, Av, M, and C Modes

6 Playback Mode

7 Wi-Fi Functions

8 Set-Up Menu

9 Accessories

10 Appendix

Index



Saving Images to a Computer

Use an interface cable (📖2) to connect your camera and save images to a personal computer.

Windows 7 and Mac OS X 10.8 are used here for the sake of illustration.

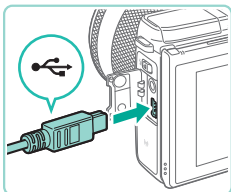

1 Connect the camera to the computer.

- With the camera turned off, open the cover (1). With the smaller plug of the cable in the orientation shown, insert the plug fully into the camera terminal (2).
- Insert the larger plug of the cable into the computer's USB port. For details about USB connections on the computer, refer to the computer user manual.

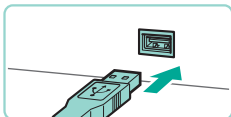

2 Turn on the camera and bring up EOS Utility.

- Press the [▶] button to turn the camera on.
- On Windows, double-click on the EOS Utility icon on the desktop.
- On Mac OS, click on the EOS Utility icon in the Dock (the bar at the bottom of the desktop screen).
- On subsequent connections, EOS Utility will start up automatically when you connect the camera to the computer and turn on the camera.

3 Import images.

- Click on [Download images to computer], then [Start automatic download].
- Images will be loaded into the computer and saved to the Pictures folder, in separate folders named by date. Digital Photo Professional will then start up automatically and display the loaded images.
- After the image-loading process is complete, close EOS Utility, press the [▶] button to turn the camera off, and unplug the cable.
- To view images loaded into your computer, use Digital Photo Professional; to view movies imported onto your computer, use software that supports the movies shot with your camera (i.e. software installed as standard on your computer or software that is generally available).

Before Use

Basic Guide

Advanced Guide

1 Camera Basics

2 Auto Mode / Hybrid Auto Mode

3 Other Shooting Modes

4 P Mode

5 Tv, Av, M, and C Modes

6 Playback Mode

7 Wi-Fi Functions

8 Set-Up Menu

9 Accessories

10 Appendix

Index





- The first time you connect the camera to the computer, drivers will be installed, so it may take a few minutes until camera images are accessible.
- Although you can save images to a computer simply by connecting your camera to the computer without using the software, the following limitations apply.
 - It may take a few minutes after you connect the camera to the computer until camera images are accessible.
 - Images shot in vertical orientation may be saved in horizontal orientation.
 - RAW images (or JPEG images recorded with RAW images) may not be saved.
 - Image protection settings may be cleared from images saved to a computer.
 - Some problems may occur when saving images or image information, depending on the operating system version, the software in use, or image file sizes.

Printing Images

▶ Still Images ▶ Movies

Your shots can easily be printed by connecting the camera to a printer. On the camera, you can specify images to set up batch printing, prepare orders for photo development services, and prepare orders or print images for photobooks.

A Canon SELPHY CP series compact photo printer is used here for the sake of illustration. Screens displayed and available functions vary by printer. Also refer to the printer manual for additional information.

Easy Print

▶ Still Images ▶ Movies

Easily print your shots by connecting the camera to a PictBridge-compatible printer (sold separately) with an interface cable (📖2).

1 Make sure the camera and printer are off.

2 Connect the camera to the printer.

- Open the terminal cover. Holding the smaller cable plug in the orientation shown, insert the plug fully into the camera terminal.
- Connect the larger cable plug to the printer. For other connection details, refer to the printer manual.

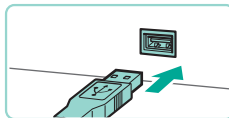
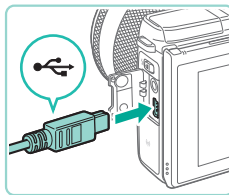

Before Use

Basic Guide

Advanced Guide

1 Camera Basics

2 Auto Mode / Hybrid Auto Mode

3 Other Shooting Modes

4 P Mode

5 Tv, Av, M, and C Modes

6 Playback Mode

7 Wi-Fi Functions

8 Set-Up Menu

9 Accessories

10 Appendix

Index





3 Turn the printer on.

4 Turn the camera on.

- Press the [▶] button to turn the camera on.

5 Choose an image.

- Press the [◀][▶] buttons or turn the [🔍] dial to choose an image.

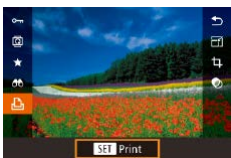

6 Access the printing screen.

- Press the [🔍] button, choose [🖨️], and press the [🔍] button again.

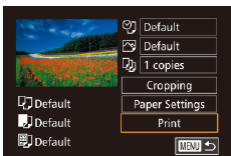

7 Print the image.

- Press the [▲][▼] buttons or turn the [🔍] dial to choose [Print], and then press the [🔍] button.
- Printing now begins.
- To print other images, repeat the above procedures starting from step 5 after printing is finished.
- When you are finished printing, turn the camera and printer off and disconnect the cable.



- For Canon-brand PictBridge-compatible printers (sold separately), see "Printers" (📖150).

Configuring Print Settings

▶ Still Images ▶ Movies

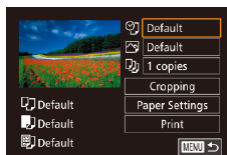

1 Access the printing screen.

- Follow steps 1 – 6 in "Easy Print" (📖160) to access this screen.

2 Configure the settings.

- Press the [▲][▼] buttons or turn the [🔍] dial to select an option. Press the [🔍] button, and on the next screen, press the [▲][▼] buttons or turn the [🔍] dial to adjust the option. Press the [🔍] button to return to the print screen.

🗨️	Default	Matches current printer settings.
	Date	Prints images with the date added.
	File No.	Prints images with the file number added.
🗨️	Both	Prints images with both the date and file number added.
	Off	–
	Default	Matches current printer settings.
🗨️	Off	–
	On	Uses information from the time of shooting to print under optimal settings.
	Red-Eye 1	Corrects red-eye.
🗨️	Copies	Choose the number of copies to print.
Cropping	–	Specify a desired image area to print (📖162).
Paper Settings	–	Specify the paper size, layout, and other details (📖162).

Before Use

Basic Guide

Advanced Guide

1 Camera Basics

2 Auto Mode / Hybrid Auto Mode

3 Other Shooting Modes

4 P Mode

5 Tv, Av, M, and C Modes

6 Playback Mode

7 Wi-Fi Functions

8 Set-Up Menu

9 Accessories

10 Appendix

Index



Cropping Images before Printing

▶ Still Images ▶ Movies

By cropping images before printing, you can print a desired image area instead of the entire image.

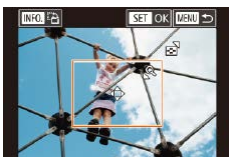
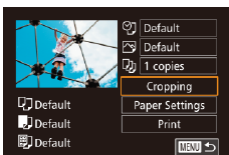

1 Choose [Cropping].

- After following step 1 in “Configuring Print Settings” (📖161) to access the printing screen, choose [Cropping] and press the [MENU] button.
- A cropping frame is now displayed, indicating the image area to print.

2 Adjust the cropping frame as needed.

- To resize the frame, press the [Q] or [📐] button or turn the [DISP] dial.
- To move the frame, press the [▲][▼][◀][▶] buttons.
- To rotate the frame, press the [INFO] button.
- When finished, press the [MENU] button.

3 Print the image.

- Follow step 7 in “Easy Print” (📖160) to print.



- Cropping may not be possible at small image sizes, or at some aspect ratios.

Choosing Paper Size and Layout before Printing

▶ Still Images ▶ Movies

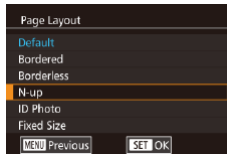
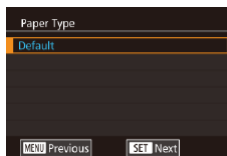
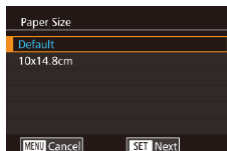
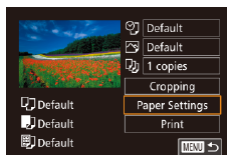

1 Choose [Paper Settings].

- After following step 1 in “Configuring Print Settings” (📖161) to access the printing screen, choose [Paper Settings] and press the [MENU] button.

2 Choose a paper size.

- Press the [▲][▼] buttons or turn the [DISP] dial to choose an option, and then press the [MENU] button.

3 Choose a type of paper.

- Press the [▲][▼] buttons or turn the [DISP] dial to choose an option, and then press the [MENU] button.

4 Choose a layout.

- Press the [▲][▼] buttons or turn the [DISP] dial to choose an option, and then press the [MENU] button.
- When choosing [N-up], press the [MENU] button. On the next screen, press the [▲][▼] buttons, or turn the [DISP] dial to choose the number of images to print, and then press the [MENU] button.

5 Print the image.

Before Use

Basic Guide

Advanced Guide

1 Camera Basics

2 Auto Mode / Hybrid Auto Mode

3 Other Shooting Modes

4 P Mode

5 Tv, Av, M, and C Modes

6 Playback Mode

7 Wi-Fi Functions

8 Set-Up Menu

9 Accessories

10 Appendix

Index



Available Layout Options

Default	Matches current printer settings.
Bordered	Prints with blank space around the image.
Borderless	Borderless, edge-to-edge printing.
N-up	Choose how many images to print per sheet.
ID Photo	Prints images for identification purposes. Only available for images with a recording pixel setting of L and an aspect ratio of 3:2.
Fixed Size	Choose the print size. Choose from 3.5 x 5 in., postcard, or wide-format prints.

Printing ID Photos

▶ Still Images ▶ Movies

1 Choose [ID Photo].

- Following steps 1 – 4 in “Choosing Paper Size and Layout before Printing” (162), choose [ID Photo] and press the [OK] button.



2 Choose the long and short side length.

- Press the [▲][▼] buttons or turn the [DISP] dial to choose an option. Press the [OK] button, and on the next screen, press the [▲][▼] buttons or turn the [DISP] dial to choose the length, and then press the [OK].

3 Choose the printing area.

- In step 2, press the [▲][▼] buttons or turn the [DISP] dial to choose [Cropping].
- Follow step 2 in “Cropping Images before Printing” (162) to choose the printing area.



4 Print the image.

Printing Movie Scenes

▶ Still Images ▶ Movies

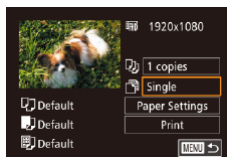

1 Access the printing screen.

- Follow steps 1 – 6 in “Easy Print” (160) to choose a movie. This screen is displayed.

2 Choose a printing method.

- Press the [▲][▼] buttons to choose [Single]. Press the [OK] button, and on the next screen, press the [▲][▼] buttons or turn the [DISP] dial to choose the printing method, and then press the [OK] button to return to the print screen.

3 Print the image.

Movie Printing Options

Single	Prints the current scene as a still image.
Sequence	Prints a series of scenes, a certain interval apart, on a single sheet of paper. You can also print the folder number, file number, and elapsed time for the frame by setting [Caption] to [On].

Before Use

Basic Guide

Advanced Guide

1 Camera Basics

2 Auto Mode / Hybrid Auto Mode

3 Other Shooting Modes

4 P Mode

5 Tv, Av, M, and C Modes

6 Playback Mode

7 Wi-Fi Functions

8 Set-Up Menu

9 Accessories

10 Appendix

Index





- To cancel printing in progress, press the **[Q]** button, choose [OK], and then press the **[Q]** button again.
- [ID Photo] and [Sequence] cannot be chosen on Canon-brand PictBridge-compatible printers from CP720/CP730 and earlier models.

Adding Images to the Print List (DPOF)

▶ Still Images ▶ Movies

Batch printing (166) and ordering prints from a photo development service can be set up on the camera. Choose up to 998 images on a memory card and configure relevant settings, such as the number of copies, as follows. The printing information you prepare this way will conform to DPOF (Digital Print Order Format) standards.



- RAW images cannot be included in print list.

Configuring Print Settings

▶ Still Images ▶ Movies

Specify the printing format, whether to add the date or file number, and other settings as follows. These settings apply to all images in the print list.

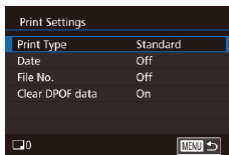

- Press the **[MENU]** button, choose [Print settings] on the **[P2]** tab, and then press the **[Q]** button.
- Press the **[▲]**/**[▼]** buttons or turn the **[DIAL]** dial to choose [Print Settings]. Press the **[Q]** button, and on the next screen, adjust the desired settings (32).

Print Type	Standard	One image is printed per sheet.
	Index	Smaller versions of multiple images are printed per sheet.
	Both	Both standard and index formats are printed.
Date	On	Images are printed with the shooting date.
	Off	–
File No.	On	Images are printed with the file number.
	Off	–
Clear DPOF data	On	All image print list settings are cleared after printing.
	Off	–



- Not all of your DPOF settings may be applied in printing by the printer or photo development service, in some cases.
- [!]** may be displayed on the camera to warn you that the memory card has print settings that were configured on another camera. Changing the print settings using this camera may overwrite all previous settings.
- Setting [Date] to [On] may cause some printers to print the date twice.



- Specifying [Index] will prevent you from choosing [On] for both [Date] and [File No.] at the same time.
- Index printing is not available on some Canon-brand PictBridge-compatible printers (sold separately).
- The date is printed in a format matching the setting details in [Date/Time] on the **[P2]** tab (18) of the menu (32).

Before Use

Basic Guide

Advanced Guide

1 Camera Basics

2 Auto Mode / Hybrid Auto Mode

3 Other Shooting Modes

4 P Mode

5 Tv, Av, M, and C Modes

6 Playback Mode

7 Wi-Fi Functions

8 Set-Up Menu

9 Accessories

10 Appendix

Index



Setting Up Printing for Individual Images

▶ Still Images ▶ Movies

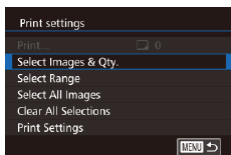

1 Choose [Select Images & Qty.].

- Press the [MENU] button, choose [Print settings] on the [▶2] tab, and then press the [⊕] button.
- Press the [▲][▼] buttons or turn the [⦿] dial to choose [Select Images & Qty.], and then press the [⊕] button (📖32).

2 Choose an image.

- Press the [◀][▶] buttons or turn the [⦿] dial to choose an image, and then press the [⊕] button.
- You can now specify the number of copies.
- If you specify index printing for the image, it is labeled with a [✓] icon. To cancel index printing for the image, press the [⊕] button again. [✓] is no longer displayed.



3 Specify the number of prints.

- Press the [▲][▼] buttons or turn the [⦿] dial to specify the number of prints (up to 99).
- To set up printing for other images and specify the number of prints, repeat steps 2 – 3.
- Printing quantity cannot be specified for index prints. You can only choose which images to print, by following step 2.
- When finished, press the [MENU] button to return to the menu screen.

Setting Up Printing for a Range of Images

▶ Still Images ▶ Movies

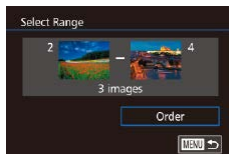

- Following step 1 in “Setting Up Printing for Individual Images” (📖165), choose [Select Range] and press the [⊕] button.
- Follow steps 2 – 3 in “Selecting a Range” (📖103) to specify images.
- Press the [▲][▼] buttons to choose [Order], and then press the [⊕] button.

Setting Up Printing for All Images

▶ Still Images ▶ Movies

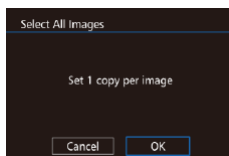

- Following step 1 in “Setting Up Printing for Individual Images” (📖165), choose [Select All Images] and press the [⊕] button.
- Press the [◀][▶] buttons or turn the [⦿] dial to choose [OK], and then press the [⊕] button.

Clearing All Images from the Print List

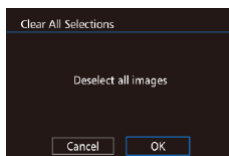

- Following step 1 in “Setting Up Printing for Individual Images” (📖165), choose [Clear All Selections] and press the [⊕] button.
- Press the [◀][▶] buttons or turn the [⦿] dial to choose [OK], and then press the [⊕] button.

Before Use

Basic Guide

Advanced Guide

1 Camera Basics

2 Auto Mode / Hybrid Auto Mode

3 Other Shooting Modes

4 P Mode

5 Tv, Av, M, and C Modes

6 Playback Mode

7 Wi-Fi Functions

8 Set-Up Menu

9 Accessories

10 Appendix

Index



Adding Images to a Photobook

▶ Still Images ▶ Movies

Photobooks can be set up on the camera by choosing up to 998 images on a memory card and importing them into the software on your computer, where they are stored in their own folder. This is convenient when ordering printed photobooks online or printing photobooks with your own printer.

Choosing a Selection Method

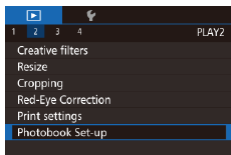

- Press the [MENU] button, choose [Photobook Set-up] on the [▶]2 tab, and then choose how you will select images.



- [!] may be displayed on the camera to warn you that the memory card has print settings that were configured on another camera. Changing the print settings using this camera may overwrite all previous settings.

Adding Images Individually

▶ Still Images ▶ Movies

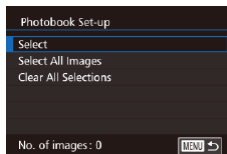

1 Choose [Select].

- Following the procedure in “Choosing a Selection Method” (166), choose [Select] and press the [MENU] button.

2 Choose an image.

- Press the [◀][▶] buttons or turn the [DISP.] dial to choose an image, and then press the [MENU] button.
- [✓] is displayed.
- To remove the image from the photobook, press the [MENU] button again. [✓] is no longer displayed.
- Repeat this process to specify other images.
- When finished, press the [MENU] button to return to the menu screen.

Adding All Images to a Photobook

▶ Still Images ▶ Movies

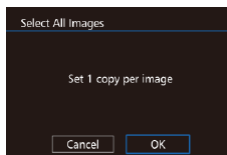

- Following the procedure in “Choosing a Selection Method” (166), choose [Select All Images] and press the [MENU] button.
- Press the [◀][▶] buttons or turn the [DISP.] dial to choose [OK], and then press the [MENU] button.

Before Use

Basic Guide

Advanced Guide

1 Camera Basics

2 Auto Mode / Hybrid Auto Mode

3 Other Shooting Modes

4 P Mode

5 Tv, Av, M, and C Modes

6 Playback Mode

7 Wi-Fi Functions

8 Set-Up Menu

9 Accessories

10 Appendix

Index



Removing All Images from a Photobook

▶ Still Images ▶ Movies

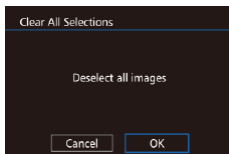

- Following the procedure in “Choosing a Selection Method” (p. 166), choose [Clear All Selections] and press the [OK] button.
- Press the [◀][▶] buttons or turn the [DISP] dial to choose [OK], and then press the [OK] button.

Before Use

Basic Guide

Advanced Guide

1 Camera Basics

2 Auto Mode / Hybrid Auto Mode

3 Other Shooting Modes

4 P Mode

5 Tv, Av, M, and C Modes

6 Playback Mode

7 Wi-Fi Functions

8 Set-Up Menu

9 Accessories

10 Appendix

Index



10

Appendix

Helpful information when using the camera

Troubleshooting

If you think there is a problem with the camera, first check the following. If the items below do not solve your problem, contact a Canon Customer Support Help Desk.

Power

Nothing happens when the power button is pressed.

- Confirm that the battery pack is charged (16).
- Confirm that the battery pack is inserted facing the correct way (17).
- Confirm that the memory card/battery cover is fully closed (17).
- Dirty battery terminals reduce battery performance. Try cleaning the terminals with a cotton swab and reinserting the battery pack a few times.

The battery pack runs out of power quickly.

- Battery performance decreases at low temperatures. Try warming the battery pack a little by putting it in your pocket, for example, ensuring that the terminals do not touch any metal objects.
- Dirty battery terminals reduce battery performance. Try cleaning the terminals with a cotton swab and reinserting the battery pack a few times.
- If these measures do not help and the battery pack still runs out of power soon after charging, it has reached the end of its life. Purchase a new battery pack.

The battery pack is swollen.

- Battery swelling is normal and does not pose any safety concerns. However, if battery swelling prevents the battery pack from fitting in the camera, contact a Canon Customer Support Help Desk.

A sound is heard when turning the camera on or off with an EF-M lens attached.

- When you turn off the camera, the lens aperture makes a small sound as it stops down to prevent light from entering the camera. This is to protect the camera's internal components.

Before Use

Basic Guide

Advanced Guide

1 Camera Basics

2 Auto Mode / Hybrid Auto Mode

3 Other Shooting Modes

4 P Mode

5 Tv, Av, M, and C Modes

6 Playback Mode

7 Wi-Fi Functions

8 Set-Up Menu

9 Accessories

10 Appendix

Index



Shooting

Cannot shoot.

- Pictures cannot be taken unless the focus is right. Press the shutter button halfway to focus on subjects. Once the frame is colored green, you can take the picture.
- In Playback mode (📖93), press the shutter button halfway (📖28).

Strange display on the screen under low light (📖30).

Strange display on the screen when shooting.

- Note that the following display problems are not recorded in still images, but are recorded in movies.
 - The screen may flicker and horizontal banding may appear under fluorescent or LED lighting.

⚡ flashes on the screen when the shutter button is pressed, and shooting is not possible (📖38).

📷 is displayed when the shutter button is pressed halfway (📖38).

- Use the Image Stabilizer when shooting (📖78).
- Raise the flash and set the flash mode to ⚡ (📖75).
- Increase the ISO speed (📖62).
- Mount the camera on a tripod or take other measures to keep it still. Additionally, the Image Stabilizer should not be used with a tripod or other means to secure the camera (📖78).

Shots are out of focus.

- Use autofocus (AF) to shoot.
- Press the shutter button halfway to focus on subjects before pressing it all the way down to shoot (📖28).
- The camera will not go into focus if you are closer than the minimum focusing distance of the lens. Check the lens you are using for its minimum focusing distance. The lens minimum focusing distance is measured from the [∞] (focal plane) mark on the top of the camera to the subject.
- Set [AF-assist Beam (LED) firing] to [0:Enable] (📖88).
- Confirm that unneeded functions, such as Manual Focus, are deactivated.
- Try shooting with focus lock or AF lock (📖70, 📖71).

Shots are blurry.

- Blurring may occur more often when touch shutter is used to shoot, depending on shooting conditions. Hold the camera still when shooting.

The AF frame is displayed in orange, and the camera does not focus when the shutter button is pressed halfway.

- To display AF frames in green and focus the camera correctly, try composing the shot with higher-contrast subject areas centered before you press the shutter button halfway. Otherwise, try pressing the shutter button halfway repeatedly.

Subjects in shots look too dark.

- Raise the flash and set the flash mode to ⚡ (📖75).
- Adjust brightness by using exposure compensation (📖61).
- Correct it with the Auto Lighting Optimizer (📖64).
- Use AE lock or spot metering (📖61, 📖62).

Subjects look too bright, highlights are washed-out.

- Lower the flash and set the flash mode to ☀️ (📖36).
- Adjust brightness by using exposure compensation (📖61).
- Shoot with the AE lock or spot metering (📖61, 📖62).
- Reduce the lighting on subjects.

Shots look too dark despite the flash firing (📖38).

- Shoot within flash range (📖196).
- Adjust brightness by using flash exposure compensation or changing the flash output level (📖76, 📖85).
- Increase the ISO speed (📖62).

Subjects in flash shots look too bright, highlights are washed-out.

- Shoot within flash range (📖196).
- Lower the flash and set the flash mode to ☀️ (📖36).
- Adjust brightness by using flash exposure compensation or changing the flash output level (📖76, 📖85).

White spots appear in flash shots.

- This is caused by light from the flash reflecting off dust or airborne particles.

Shots look grainy.

- Lower the ISO speed (📖62).
- High ISO speeds in some shooting modes may cause grainy images (📖51).

Before Use

Basic Guide

Advanced Guide

1 Camera Basics

2 Auto Mode / Hybrid Auto Mode

3 Other Shooting Modes

4 P Mode

5 Tv, Av, M, and C Modes

6 Playback Mode

7 Wi-Fi Functions

8 Set-Up Menu

9 Accessories

10 Appendix

Index



There is linear noise or a moiré pattern in the image

- Depending on the subject, linear noise or a moiré pattern may appear in the image.
This can occur especially in - the following conditions.
 - Subjects with fine horizontal stripes or checkered patterns, etc.
 - When there are strong light sources such as sunlight or illumination in or close to the shooting screen.In these situations, noise and moiré patterns can be reduced by taking the following actions.
 - Change the shooting range or zoom factor, or resize the subject.
 - Recompose the shot so that strong light sources do not enter the shooting screen.
 - Attach a hood to the lens so that strong light sources do not enter the lens.
- If you shift or tilt the lens when using a TS-E lens, linear noise or a moiré pattern may be recorded in the image.

Subjects are affected by red-eye.

- Set [Red-eye reduc.] to [On] (📖47). The red-eye reduction lamp (📖3) will be activated in flash shots. For best results, have subjects look at the red-eye reduction lamp. Also try increasing the lighting in indoor scenes and shooting at closer range.
- Edit images using red-eye correction (📖112).

Recording to the memory card takes too long, or continuous shooting is slower.

- Use the camera to perform low-level formatting of the memory card (📖138).

Continuous shooting suddenly stops.

- To protect the camera, continuous shooting will stop after 1000 pictures in a single shot. Release your finger from the shutter button once, and resume shooting.

Shooting settings or the quick setting menu is not available.

- Available setting items vary by shooting mode. Refer to "Functions Available in Each Shooting Mode", "Quick Settings", "Shooting Tabs", "C.Fn Tab", "INFO. Quick Control", and "Set UP Tab" (📖177 – 📖187).

Touch AF or Touch Shutter does not work.

- Touch AF or Touch Shutter will not work if you touch the edges of the screen. Touch closer to the center of the screen.

Shooting Movies

The elapsed time shown is incorrect, or recording is interrupted.

- Use the camera to format the memory card, or switch to a card that supports high-speed recording. Note that even if the elapsed time display is incorrect, the length of movies on the memory card corresponds to the actual recording time.

A "full buffer" warning (📖174) is displayed and shooting stops automatically.

- The camera's internal memory buffer filled up as the camera could not record to the memory card quickly enough. Try one of the following measures.
 - Use the camera to perform low-level formatting of the memory card (📖138).
 - Lower the image quality (📖45).
 - Switch to a memory card that supports high-speed recording.

Subjects look distorted.

- Subjects that pass in front of the camera quickly may look distorted. This is not a malfunction.

Movie seems to stop momentarily.

- With some lenses, the movie is recorded in such a way that the image appears to drop a frame at moments when the brightness changes significantly.

Playback

Playback is not possible.

- Image or movie playback may not be possible if a computer is used to rename files or alter the folder structure.

Playback stops, or audio skips.

- Switch to a memory card that you have performed low-level formatting on with the camera (📖138).
- There may be brief interruptions when playing movies copied to memory cards that have slow read speeds.
- When movies are played on a computer, frames may be dropped and audio may skip if computer performance is inadequate.

Sound is not played during movies.

- Adjust the volume (📖93) if the sound in the movie is faint.
- No sound is played for movies shot in [📷] mode (📖55) because audio is not recorded in this mode.

Before Use

Basic Guide

Advanced Guide

1 Camera Basics

2 Auto Mode / Hybrid Auto Mode

3 Other Shooting Modes

4 P Mode

5 Tv, Av, M, and C Modes

6 Playback Mode

7 Wi-Fi Functions

8 Set-Up Menu

9 Accessories

10 Appendix

Index



Computer

Cannot transfer images to a computer.

- When attempting to transfer images to the computer via a cable, try reducing the transfer speed as follows.
 - Press the [▶] button to enter Playback mode. Hold the [MENU] button down as you press the [▲] and [Ⓜ] buttons at the same time. On the next screen, press the [◀][▶] buttons to choose [B], and then press the [Ⓜ] button.

Wi-Fi

Cannot access the Wi-Fi menu by pressing the [▲] button.

- The Wi-Fi menu is not available in Shooting mode. Switch to Playback mode and try again.
- In Playback mode, the Wi-Fi menu cannot be accessed during magnified display or index display. Switch to single-image display and try again. Similarly, the Wi-Fi menu cannot be accessed during filtered image display according to specified conditions. Cancel filtered image playback.
- The Wi-Fi menu cannot be accessed while the camera is connected to a printer. Disconnect the cable.

Cannot add a device/destination.

- A total of 20 items of connection information can be added to the camera. Erase unneeded connection information from the camera first, and then add new devices/destinations (📖135).
- Use a computer or smartphone to register Web services (📖122).
- To add a smartphone, first install the dedicated application on your smartphone (📖116).
- Do not use the camera near sources of Wi-Fi signal interference, such as microwave ovens, Bluetooth devices, or other equipment operating on the 2.4 GHz band.
- Bring the camera closer to the other device you are trying to connect to (such as the access point), and make sure there are no objects between the devices.

Cannot connect to the access point.

- Confirm that the access point channel is set to a channel supported by the camera (📖194). Note that instead of auto channel assignment, it is advisable to specify a supported channel manually.

Cannot send images.

- The destination device has insufficient storage space. Increase the storage space on the destination device and resend the images.

- The write-protect tab of the memory card in the destination camera is set to the locked position. Slide the write-protect tab to the unlocked position.
- RAW images cannot be imported to the camera or displayed on a TV set. If you select a RAW image on the smartphone, it is imported as a JPEG file. Send RAW images using Image Sync.
- Images are not sent to CANON iMAGE GATEWAY or other Web services if you move or rename image files or folders on the computer that received images sent using Image Sync via an access point (📖131). Before moving or renaming these image files or folders on the computer, make sure the images have already been sent to CANON iMAGE GATEWAY or other Web services.

Cannot resize images for sending.

- Images cannot be resized to be bigger than the resolution setting of their original size.
- Movies cannot be resized.

Images take a long time to send/The wireless connection is disrupted.

- Multiple images may take a long time to send. Try resizing the image to [S2] or [S3] to reduce sending time (📖131).
- Movies may take a long time to send.
- Do not use the camera near sources of Wi-Fi signal interference, such as microwave ovens, Bluetooth devices, or other equipment operating on the 2.4 GHz band. Note that images may take a long time to send even when [Ti] is displayed.
- Bring the camera closer to the other device you are trying to connect to (such as the access point), and make sure there are no objects between the devices.

Want to erase Wi-Fi connection information before disposing of the camera or giving it to someone else.

- Reset the Wi-Fi settings (📖136).

Before Use

Basic Guide

Advanced Guide

1 Camera Basics

2 Auto Mode / Hybrid Auto Mode

3 Other Shooting Modes

4 P Mode

5 Tv, Av, M, and C Modes

6 Playback Mode

7 Wi-Fi Functions

8 Set-Up Menu

9 Accessories

10 Appendix

Index



On-screen Messages

If an error message is displayed, respond as follows.

Capture or Playback

No memory card

- The memory card may be inserted facing the wrong way. Reinsert the memory card facing the correct way (📖17).

Memory card locked

- The write-protect tab of the memory card is set to the locked position. Switch the write-protect tab to the unlocked position (📖17).

Cannot record!

- Shooting was attempted without a memory card in the camera. To shoot, insert a memory card facing the correct way (📖17).

Memory card error (📖138)

- If the same error message is displayed even after you have formatted a supported memory card (📖2) and have inserted it facing the correct way (📖17), contact a Canon Customer Support Help Desk.

Insufficient space on card

- There is not enough free space on the memory card to shoot (📖35, 📖48, 📖60) or edit images (📖109). Either erase unneeded images (📖105) or insert a memory card with enough free space (📖17).

Touch AF canceled

- The subject selected for Touch AF can no longer be detected (📖71).

Charge the battery (📖16)

No Image.

- The memory card does not contain any images that can be displayed.

Protected! (📖102)

Unidentified Image/Incompatible JPEG/Image too large./Cannot play back MOV/Cannot play back MP4

- Unsupported or corrupt images cannot be displayed.
- It may not be possible to display images that were edited or renamed on a computer, or images shot with another camera.

Cannot magnify!/Cannot rotate/Cannot modify image/Cannot modify/Unselectable image.

- The following functions may be unavailable for images that were renamed or already edited on a computer, or images shot with another camera. Note that starred (*) functions are not available for movies. Magnify (📖100)*, Rotation (📖107)*, Rating (📖108), Editing (📖109)*, Print List (📖164)*, Photobook Set-up (📖166)*

Invalid selection range

- When specifying a range for image selection (📖103, 📖106, 📖165), you attempted to choose an initial image that was after the final image, or vice-versa.

Exceeded selection limit

- More than 998 images were selected for Print List (📖164) or Photobook Set-up (📖166). Choose 998 images or less.
- Print List (📖164) or Photobook Set-up (📖166) settings could not be saved correctly. Reduce the number of selected images and try again.
- You attempted to choose more than 500 images in Protect (📖102), Erase (📖105), Rating (📖108), Print List (📖164), or Photobook Set-up (📖166).

Naming error!

- The folder could not be created or images could not be recorded, because the highest supported folder number (999) for storing images on the card has been reached and the highest supported image number (9999) for images in folders has been reached. Either format the memory card (📖138) or go to the menu (📖32), select the [👉1] tab, and change [File No.] to [Auto Reset] (📖137).

Lens Error

- Communication between the camera and lens is faulty. Clean the lens contacts and fit correctly on the camera.
- Frequent display of this error message may indicate camera damage. In this case, contact a Canon Customer Support Help Desk.

A camera error was detected (*error number*)

- If this error message is displayed immediately after a shot, the image may not have been saved. Switch to Playback mode to check for the image.
- Frequent display of this error message may indicate camera damage. In this case, write down the error number (*Exx*) and contact a Canon Customer Support Help Desk.

File Error

- Correct printing (📖160) may not be possible for photos from other cameras or images that have been altered using computer software, even if the camera is connected to the printer.

Before Use

Basic Guide

Advanced Guide

1 Camera Basics

2 Auto Mode / Hybrid Auto Mode

3 Other Shooting Modes

4 P Mode

5 Tv, Av, M, and C Modes

6 Playback Mode

7 Wi-Fi Functions

8 Set-Up Menu

9 Accessories

10 Appendix

Index



Print error

- Check the paper size setting (📖162). If this error message is displayed when the setting is correct, restart the printer and complete the setting on the camera again.

Ink absorber full

- Contact a Canon Customer Support Help Desk to request assistance with ink absorber replacement.

Wi-Fi

Connection failed

- No access points were recognized. Check the access point settings (📖120).
- A device could not be found. Turn the camera off and on again, and retry the connection.
- Check the device you want to connect to and make sure it is ready for connection.

Cannot determine access point

- The WPS buttons on numerous access points were pressed simultaneously. Try reconnecting again.

No access points found

- Check to make sure that the access point is turned on.
- When connecting to an access point manually, make sure that you entered the correct SSID.

Incorrect password/Incorrect Wi-Fi security settings

- Check the access point security settings (📖119).

IP address conflict

- Reset the IP address so that it does not conflict with another.

Disconnected/Receiving failed/Sending failed

- You may be in an environment where Wi-Fi signals are obstructed.
- Avoid using the camera's Wi-Fi function around microwave ovens, Bluetooth devices, and other devices that operate on the 2.4 GHz band.
- Bring the camera closer to the other device you are trying to connect to (such as the access point), and make sure there are no objects between the devices.
- Check the connected device to make sure it is not experiencing errors.

Sending failed

Memory card error

- If the same error message is displayed even when you have inserted a formatted memory card facing the correct way, contact a Canon Customer Support Help Desk.

Receiving failed

Insufficient space on card

- There is not enough free space on the memory card in the target camera to receive images. Erase images to create space on the memory card, or insert a memory card with sufficient space.

Receiving failed

Memory card locked

- The write-protect tab of the memory card in the camera to receive the images is set to the locked position. Slide the write-protect tab to the unlocked position.

Receiving failed

Naming error!

- When the highest folder number (999) and the highest image number (9999) have been reached on the receiving camera, images cannot be received.

Insufficient space on server

- Delete unnecessary images uploaded to CANON iMAGE GATEWAY to create space.
- Save the images sent via Image Sync (📖131) to your computer.

Check network settings

- Check to make sure your computer can connect to the Internet with the current network settings.

Before Use

Basic Guide

Advanced Guide

1 Camera Basics

2 Auto Mode / Hybrid Auto Mode

3 Other Shooting Modes

4 P Mode

5 Tv, Av, M, and C Modes

6 Playback Mode

7 Wi-Fi Functions

8 Set-Up Menu

9 Accessories

10 Appendix

Index



On-screen Information

During Shooting

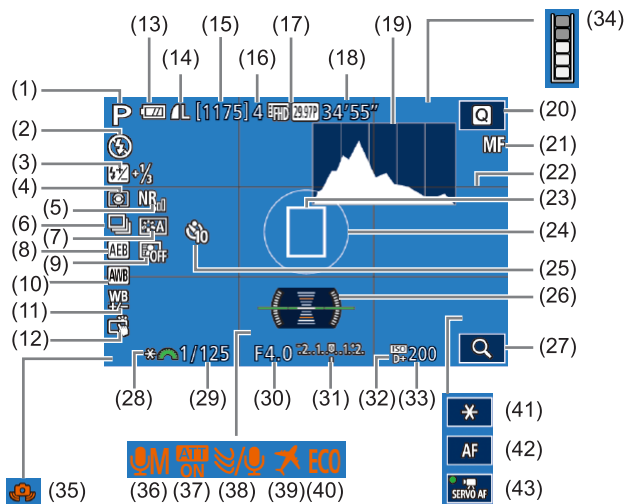

- (1) Shooting mode (177), Scene icon (39)
- (2) Flash mode (75), LED light (155)
- (3) Flash exposure compensation / Flash output level (76, 85)
- (4) Metering mode (62)
- (5) High ISO speed NR (80)
- (6) Continuous shooting (42)
- (7) Picture Style (67)
- (8) AEB (63)
- (9) Auto Lighting Optimizer (64)
- (10) White balance (65)
- (11) White balance correction (66)
- (12) Touch Shutter (41)
- (13) Shooting mode (177), Scene icon (39)
- (14) Flash mode (75), LED light (155)
- (15) Flash exposure compensation / Flash output level (76, 85)
- (16) Metering mode (62)
- (17) High ISO speed NR (80)
- (18) Continuous shooting (42)
- (19) Picture Style (67)
- (20) AEB (63)
- (21) Auto Lighting Optimizer (64)
- (22) White balance (65)
- (23) White balance correction (66)
- (24) Touch Shutter (41)
- (25) Shooting mode (177), Scene icon (39)
- (26) Flash mode (75), LED light (155)
- (27) Flash exposure compensation / Flash output level (76, 85)
- (28) Metering mode (62)
- (29) High ISO speed NR (80)
- (30) Continuous shooting (42)
- (31) Picture Style (67)
- (32) AEB (63)
- (33) Auto Lighting Optimizer (64)
- (34) White balance (65)
- (35) White balance correction (66)
- (36) Touch Shutter (41)
- (37) Shooting mode (177), Scene icon (39)
- (38) Flash mode (75), LED light (155)
- (39) Flash exposure compensation / Flash output level (76, 85)
- (40) Metering mode (62)
- (41) High ISO speed NR (80)
- (42) Continuous shooting (42)
- (43) Picture Style (67)

- (13) Battery level (174)
- (14) Still image quality (compression, resolution) (43)
- (15) Recordable shots
- (16) Maximum burst
- (17) Movie quality (resolution, frame rate) (45)
- (18) Remaining time
- (19) Histogram (96)
- (20) Quick setting menu (31)
- (21) Manual focus (74)
- (22) Grid lines (30)
- (23) AF frame (69)
- (24) AE Point frame (62)
- (25) Self-timer (40)
- (26) Electronic level (46)
- (27) Magnify (74)
- (28) AE lock (61)
- (29) Shutter speed (82)
- (30) Aperture value (83)
- (31) Exposure compensation (61)
- (32) Highlight tone priority (64)
- (33) ISO speed (62)
- (34) Buffer warning (170)
- (35) Camera shake warning (38)
- (36) Recording mode (59)
- (37) Attenuator (59)
- (38) Wind filter (59)
- (39) Time zone (141)
- (40) Eco mode (139)
- (41) AE lock (movie) (58)
- (42) AF/MF toggle (57)
- (43) Movie Servo AF (57)

Battery Level

An on-screen icon or message indicates the battery charge level.

Display	Details
	Sufficient charge
	Slightly depleted, but sufficient.
	Nearly depleted. Recharge the battery.
[Charge the battery]	No charge left. Recharge the battery immediately.

Before Use

Basic Guide

Advanced Guide

1 Camera Basics

2 Auto Mode / Hybrid Auto Mode

3 Other Shooting Modes

4 P Mode

5 Tv, Av, M, and C Modes

6 Playback Mode

7 Wi-Fi Functions

8 Set-Up Menu

9 Accessories

10 Appendix

Index



Playback

Info Display 1

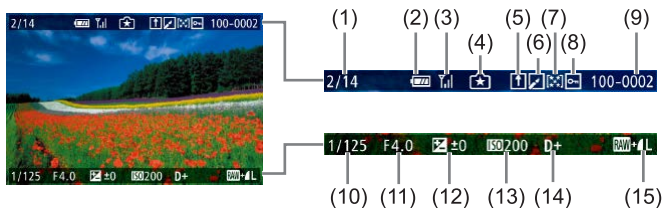

- | | |
|---|----------------------------------|
| (1) Image shown/number of target images | (8) Protect |
| (2) Battery level | (9) Folder number - File number |
| (3) Wi-Fi status | (10) Shutter speed |
| (4) Settings can be applied to mode | (11) Aperture value |
| (5) Sent to Image Sync | (12) Exposure compensation level |
| (6) Edited*1 | (13) ISO speed |
| (7) Rating | (14) Highlight tone priority |
| | (15) Image quality*2 |

*1 Displayed on images that have Creative Filter, resize, cropping, or red-eye correction applied to them.

*2 Cropped images have displayed.

Info Display 2

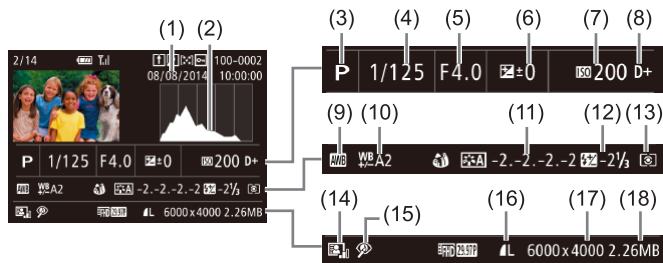

- | | |
|-----------------------------|----------------------------------|
| (1) Shooting date/time | (10) White balance correction |
| (2) Histogram | (11) Picture Style settings |
| (3) Shooting mode | (12) Flash exposure compensation |
| (4) Shutter speed | (13) Metering mode |
| (5) Aperture value | (14) Auto Lighting Optimizer |
| (6) Exposure compensation | (15) Red-eye correction |
| (7) ISO speed | (16) Image quality* |
| (8) Highlight tone priority | (17) Resolution |
| (9) White balance | (18) Image size |

* Cropped images have displayed.

Info Display 3

Shows the lens name, focal distance, and an RGB histogram. The screen may not be wide enough to display the full name of the lens. The display on the top of the screen is the same as Info Display 2.

Info Display 4

Displays Picture Style data. The display on the top of the screen is the same as Info Display 2.

Before Use

Basic Guide

Advanced Guide

1 Camera Basics

2 Auto Mode / Hybrid Auto Mode

3 Other Shooting Modes

4 P Mode

5 Tv, Av, M, and C Modes

6 Playback Mode

7 Wi-Fi Functions

8 Set-Up Menu

9 Accessories

10 Appendix

Index



Info Display 5

Displays noise-reduction settings for long exposure and high-speed shooting. The display on the top of the screen is the same as Info Display 2.

Info Display 6

Displays lens correction data, peripheral illumination, and chromatic aberration data. The display on the top of the screen is the same as Info Display 2.

Summary of Movie Control Panel

The following operations are available on the movie control panel shown in [View] (📖93).

▶	Playback
▶	Slow Motion (Press the [◀][▶] buttons to adjust the playback speed. No sound is played.) (To adjust the playback speed, press the [◀][▶] buttons or turn the [🔘] dial. No sound is played.)
◀	Skip Backward* or Previous Clip (📖114) (To continue skipping backward, keep touching the [🔘] button.)
◀◀	Previous Frame (For fast-rewind, keep holding down the [🔘] button.)
▶▶	Next Frame (For fast-forward, keep holding down the [🔘] button.)
▶	Skip Forward* or Next Clip (📖114) (To continue skipping forward, keep holding down the [🔘] button.)
🗑️	Erase Clip (displayed when a digest movie is selected (📖114))
✂️	Edit (📖113)
🖨️	Shown when the camera is connected to a PictBridge-compatible printer (📖160).

* Displays the frame approx. 4 sec. before or after the current frame.



- During movie playback, you can skip back or forward (or to the previous or next clip) by pressing the [◀][▶] buttons.
- To switch frames, touch the scrollbar or drag left or right.

Before Use

Basic Guide

Advanced Guide

1 Camera Basics

2 Auto Mode / Hybrid Auto Mode

3 Other Shooting Modes

4 P Mode

5 Tv, Av, M, and C Modes

6 Playback Mode

7 Wi-Fi Functions

8 Set-Up Menu

9 Accessories

10 Appendix

Index



Functions and Menu Tables

Before Use

Basic Guide

Advanced Guide

Functions Available in Each Shooting Mode

Function \ Shooting Mode		Shooting Mode																				
		C	M	Av	Tv	P	A+	A-	A*	SR	SR+	SR-	SR+	SR-	SR+	SR-	HDR	SR	SR+	SR-	SR+	SR-
Exposure compensation (p.61)		○	○	○	○	○	-	-	*1	○	○	○	○	○	○	○	○	○	○	○	○	-
ISO speed (p.62)	AUTO	*2	○	○	○	○	○	○	○	○	○	○	○	○	○	○	○	○	○	○	○	○
	100 – 6400	*2	○	○	○	○	-	-	-	-	-	-	-	-	-	-	-	-	-	-	-	○
	8000, 10000, 12800	*2	○	○	○	○	-	-	-	-	-	-	-	-	-	-	-	-	-	-	-	-
Flash (p.75)	Auto	*2	-	-	-	○	○	○	○	-	○	-	○	-	-	○	○	○	○	○	○	-
	On	*2	○	○	○	○	-	-	○	○	-	○	-	○	○	-	○	○	○	○	○	-
	Slow Synchro	*2	-	○	-	○	*3	*3	○	-	-	-	-	*3	-	-	-	-	-	-	-	-
	Off	*2	○	○	○	○	○	○	○	○	○	○	○	○	○	○	○	○	○	○	○	○
External Flash Firing (p.154)		*2	○	○	○	○	○	○	○	-	○	-	○	○	-	○	○	○	○	○	○	-
Flash Exposure Compensation (p.76)		*2	○	○	○	○	-	-	*4	-	-	-	-	-	-	-	-	-	-	-	-	-
Flash Output (p.85)		*2	○	○	○	-	-	-	-	-	-	-	-	-	-	-	-	-	-	-	-	-
Aperture value (p.83)		*2	○	○	-	-	-	-	-	-	-	-	-	-	-	-	-	-	-	-	-	○
Shutter speed (p.82)		*2	○	-	○	-	-	-	-	-	-	-	-	-	-	-	-	-	-	-	-	○
Bulb Exposures (p.85)		*2	○	-	-	-	-	-	-	-	-	-	-	-	-	-	-	-	-	-	-	-
Program Shift (p.62)		*2	-	-	-	○	-	-	-	-	-	-	-	-	-	-	-	-	-	-	-	-

1 Camera Basics

2 Auto Mode / Hybrid Auto Mode

3 Other Shooting Modes

4 P Mode

5 Tv, Av, M, and C Modes

6 Playback Mode

7 Wi-Fi Functions

8 Set-Up Menu

9 Accessories

10 Appendix

Index



Function	Shooting Mode	Shooting Modes																								
		C	M	Av	Tv	P	A+	A-	★	↻	📷	🌿	👤	📄	🍴	HDR	🌐	👉	👆	📷	👤	📄	📺	📺		
AE Lock (📖58, 📖61), FE Lock (📖76)	*2	○	○	○	○	○	–	–	–	–	–	–	–	–	–	–	–	–	–	–	–	–	–	–	*5	*5
AE Lock when shooting movies, Exposure Compensation (📖58)	*2	○	○	○	○	○	–	–	–	○	○	○	○	○	○	○	○	○	○	○	○	○	○	○	○	*5
Manual Focus (📖74)*6	*2	○	○	○	○	○	–	–	○	○	○	○	–	○	○	○	○	○	○	○	○	○	○	○	○	○
Manual Focus Switching when Shooting Movies (📖57)	*2	○	○	○	○	○	–	–	○	○	○	○	–	○	○	○	○	○	○	○	○	○	○	○	○	○
Move AF Frame (📖71)	*2	○	○	○	○	○	–	–	○	○	○	○	○	○	○	○	○	○	○	○	○	○	○	○	○	○
Touch AF (📖71)	*2	○	○	○	○	○	○	○	○	○	○	○	○	○	○	○	○	○	○	○	○	○	○	○	○	○
Face Select (📖71)	*2	○	○	○	○	○	○	○	○	○	○	○	○	○	○	○	○	○	○	○	○	○	○	○	○	○
Magnified Display (📖74)	*2	○	○	○	○	○	–	–	○	○	○	○	○	○	○	○	○	○	○	○	○	○	○	○	○	○
Touch Shutter (📖41)	*2	○	○	○	○	○	○	○	○	○	○	○	○	○	○	○	○	○	○	○	○	○	○	○	○	○
Single Frame Shoot when shooting movies (📖58)*8	*2	○	○	○	○	○	○	○	○	○	○	○	○	○	○	○	○	○	○	○	○	○	○	○	○	○
Change Display (📖30, 📖61)	Custom display 1/ Custom display 2/ No info display	*2	○	○	○	○	○	○	○	○	○	○	○	○	○	○	○	○	○	○	○	○	○	○	○	○
	INFO. Quick Control	*2	○	○	○	○	○	○	○	○	○	○	○	○	○	○	○	○	○	○	○	○	○	○	○	○

- *1 Set using [Brightness].
 - *2 Adjustable content depends on added shooting modes.
 - *3 Not selectable. However, switches to [📷] in some cases.
 - *4 Geared to [Brightness] setting.
 - *5 AE Lock only.
 - *6 Manual Focus when switched to MF using switch on EF lens or EF-S lens.
 - *7 Shooting only. Subject cannot be specified.
 - *8 Stills are shot with the same aspect ratio as movies.
- Selectable or set automatically. – Not selectable.

- Before Use
- Basic Guide
- Advanced Guide
 - 1 Camera Basics
 - 2 Auto Mode / Hybrid Auto Mode
 - 3 Other Shooting Modes
 - 4 P Mode
 - 5 Tv, Av, M, and C Modes
 - 6 Playback Mode
 - 7 Wi-Fi Functions
 - 8 Set-Up Menu
 - 9 Accessories
 - 10 Appendix
- Index



Quick Settings

Function		Shooting Mode																									
		C	M	Av	Tv	P										HDR											
AF method (📖69)	AF	*1	○	○	○	○	○	○	*2	○	○	○	○	○	○	○	○	○	○	○	○	○	○				
	AF	*1	○	○	○	○	-	-	*2	○	○	○	○	○	○	○	○	○	○	○	○	○	○				
AF operation (📖72)	ONESHOT	*1	○	○	○	○	○	○	*2	○	○	○	-	○	○	○	○	○	○	○	○	○	○				
	SERVO	*1	○	○	○	○	-	-	*2	-	-	-	○	-	-	○	-	○	○	-	○	-	-				
Image quality (📖43)		See "Shooting Tabs" (📖181).																									
Movie rec. size (📖45)	When set to [NTSC]		*1	○	○	○	○	○	*3	○	○	○	○	○	○	○	○	○	○	-	○	○	○	○			
			*1	○	○	○	○	○	*3	○	○	○	○	○	○	○	○	○	○	*4	○	○	○	○			
	When set to [PAL]		*1	○	○	○	○	○	*3	○	○	○	○	○	○	○	○	○	○	-	○	○	○	○			
			*1	○	○	○	○	○	*3	○	○	○	○	○	○	○	○	○	○	*4	○	○	○	○			
Drive Mode (📖42)		*1	○	○	○	○	○	○	○	○	○	○	○	○	○	○	○	○	○	○	○	○	○				
		*1	○	○	○	○	○	-	-	○	○	○	○	-	○	-	-	-	-	-	-	-	○				
Self-timer/Remote ctrl (📖40)		*1	○	○	○	○	○	○	○	○	○	○	○	○	○	○	○	○	○	○	○	○	○				
		*1	○	○	○	○	○	○	-	○	○	○	○	○	○	○	○	○	○	○	○	○	○				
White balance (📖65)	AWB	*1	○	○	○	○	○	○	○	○	○	○	○	○	○	○	○	○	○	○	○	○	○				
		*1	○	○	○	○	-	-	-	-	-	-	-	-	-	-	-	-	-	-	-	-	○				
		*1	○	○	○	○	-	-	-	-	-	-	-	-	-	-	-	-	-	-	-	-	-				
WB Correction (📖66)		*1	○	○	○	○	-	-	-	-	-	-	-	-	-	-	-	-	-	-	-	-	○				

Before Use

Basic Guide

Advanced Guide

1 Camera Basics

2 Auto Mode / Hybrid Auto Mode

3 Other Shooting Modes

4 P Mode

5 Tv, Av, M, and C Modes

6 Playback Mode

7 Wi-Fi Functions

8 Set-Up Menu

9 Accessories

10 Appendix

Index



Function	Shooting Mode	Shooting Mode																					
		C	M	Av	Tv	P	A+	+	*	+	+	+	+	+	+	HDR	+	+	+	+	+		
Picture Style (67)		*1	O	O	O	O	O	O	-	O	O	O	O	O	-	O	-	-	-	-	O	O	
		*1	O	O	O	O	-	-	O	-	-	-	-	O	-	O	O	O	O	O	O	O	
		*1	O	O	O	O	-	-	-	-	-	-	-	-	-	-	-	-	-	-	O	O	
		*1	O	O	O	O	-	-	*5	-	-	-	-	-	-	-	-	-	-	-	-	O	O
Auto Lighting Optimizer (64)		*1	O	O	O	O	-	-	O	-	-	-	-	O	-	O	O	O	O	O	O	O	
		*1	O	O	O	O	-	-	-	-	-	-	-	-	-	-	-	-	-	-	-	O	O
		*1	O	O	O	O	O	O	-	O	O	O	O	-	O	-	-	-	-	-	-	O	O
Metering mode (62)		*1	O	O	O	O	O	O	O	O	O	O	O	O	O	O	O	O	O	O	O	O	O
		*1	O	O	O	O	-	-	-	-	-	-	-	-	-	-	-	-	-	-	-	-	-
Still Image Aspect Ratio (45)	3:2	*1	O	O	O	O	O	O	*6	O	O	O	O	O	O	O	O	O	O	-	O	O	-
	4:3/16:9	*1	O	O	O	O	O	-	*6	O	O	O	O	O	O	O	O	O	O	O	O	*7	*7
	1:1	*1	O	O	O	O	O	-	*6	O	O	O	O	O	O	O	O	O	O	-	O	O	-

*1 Adjustable content depends on added shooting modes.

*2 Set using menu tab [2].

*3 Set using menu tab [5].

*4 Synchronizes with aspect ratio setting and is automatically set (55).

*5 If [Monochrome] is set to anything other than [OFF], it is set automatically.

*6 Set using menu tab [1].

*7 Set automatically, geared to aspect ratio of movie rec. size.

O Selectable or set automatically. - Not selectable.

Before Use

Basic Guide

Advanced Guide

1 Camera Basics

2 Auto Mode / Hybrid Auto Mode

3 Other Shooting Modes

4 P Mode

5 Tv, Av, M, and C Modes

6 Playback Mode

7 Wi-Fi Functions

8 Set-Up Menu

9 Accessories

10 Appendix

Index



Shooting Tabs

Function		Shooting Mode		C	M	Av	Tv	P									HDR											
		Image quality (143)																										
	JPEG	–	*1	○	○	○	○	○	○	–	–	○	–	–	○	–	–	–	–	–	–	–	–	○	○			
			*1	○	○	○	○	○	○	○	○	○	○	○	○	○	○	○	○	○	○	○	○	○	○	○	○	
			*1	○	○	○	○	○	○	–	○	○	○	○	○	○	○	○	○	○	○	○	○	○	○	○	○	
	RAW	–	*1	○	○	○	○	○	○	○	○	○	○	○	○	○	○	○	○	○	○	○	○	○	○	○	○	
			*1	○	○	○	○	○	○	–	–	○	–	–	○	–	–	–	–	–	–	–	–	–	○	○		
	Still Image Aspect Ratio (45)		See "Quick Settings" (179).																									
	Shooting information display (87)		*1	○	○	○	○	○	○	○	○	○	○	○	○	○	○	○	○	○	○	○	○	○	○	○	○	
	Reverse Disp. (29)		On/Off	*1	○	○	○	○	○	○	○	○	○	○	○	○	○	○	○	○	○	○	○	○	○	○	○	
	Image review (47)*2		Off/2 sec./ 4 sec./ 8 sec./Hold	*1	○	○	○	○	○	○	○	○	○	○	○	○	○	○	○	○	○	○	○	○	○	○	○	
	Touch Shutter (41)		Enable	*1	○	○	○	○	○	○	○	○	○	○	○	○	○	○	○	○	○	○	○	○	○	○	○	
Disable			*1	○	○	○	○	○	○	○	○	○	○	○	○	○	○	○	○	○	○	○	○	○	○	○		
Display Mode (153)*3		Power Saving	*1	○	○	○	○	○	○	○	○	○	○	○	○	○	○	○	○	○	○	○	○	○	○	○		
		Smooth	*1	○	○	○	○	○	○	○	○	○	○	○	○	○	○	○	○	○	○	○	○	○	○	○		

Before Use

Basic Guide

Advanced Guide

1 Camera Basics

2 Auto Mode /
Hybrid Auto Mode

3 Other Shooting Modes

4 P Mode

5 Tv, Av, M, and C Modes

6 Playback Mode

7 Wi-Fi Functions

8 Set-Up Menu

9 Accessories

10 Appendix

Index



Function		Shooting Mode		C	M	Av	Tv	P	A+	+	*	⬅	⬆	⬇	⬅	⬆	⬇	⬅	⬆	⬇	HDR	⬅	⬆	⬇	⬅	⬆	⬇	⬅	⬆	⬇	⬅	⬆	⬇					
2	AF operation (72)		See "Quick Settings" (179).																																			
	AF method (69)		See "Quick Settings" (179).																																			
	Continuous AF (73)	On	*1	○	○	○	○	○	○	○	○	○	○	○	○	○	○	○	○	○	○	○	○	○	○	○	○	○	○	○	○	○	○	○	○	○	○	
		Off	*1	○	○	○	○	○	○	○	○	○	○	○	○	○	○	○	○	○	○	○	○	○	○	○	○	○	○	○	○	○	○	○	○	○	○	○
	AF+MF (73)	On	*1	○	○	○	○	○	○	○	○	○	○	○	○	○	○	○	○	○	○	○	○	○	○	○	○	○	○	○	○	○	○	○	○	○	○	○
		Off	*1	○	○	○	○	○	○	○	○	○	○	○	○	○	○	○	○	○	○	○	○	○	○	○	○	○	○	○	○	○	○	○	○	○	○	○
	MF Peaking Settings (74)		*1	○	○	○	○	○	○	○	○	○	○	○	○	○	○	○	○	○	○	○	○	○	○	○	○	○	○	○	○	○	○	○	○	○	○	○
	IS Settings (78)	IS Mode**	Off	*1	○	○	○	○	○	○	○	○	○	○	○	○	○	○	○	○	○	○	○	○	○	○	○	○	○	○	○	○	○	○	○	○	○	○
			Continuous	*1	○	○	○	○	○	○	○	○	○	○	○	○	○	○	○	○	○	○	○	○	○	○	○	○	○	○	○	○	○	○	○	○	○	○
		Dynamic IS**	1	*1	○	○	○	○	○	○	○	○	○	○	○	○	○	○	○	○	○	○	○	○	○	○	○	○	○	○	○	○	○	○	○	○	○	○
2	*1		○	○	○	○	○	○	○	○	○	○	○	○	○	○	○	○	○	○	○	○	○	○	○	○	○	○	○	○	○	○	○	○	○	○	○	○
Lens aberration correction (79)		*1	○	○	○	○	○	○	○	○	○	○	○	○	○	○	○	○	○	○	○	○	○	○	○	○	○	○	○	○	○	○	○	○	○	○	○	○

Before Use

Basic Guide

Advanced Guide

1 Camera Basics

2 Auto Mode / Hybrid Auto Mode

3 Other Shooting Modes

4 P Mode

5 Tv, Av, M, and C Modes

6 Playback Mode

7 Wi-Fi Functions

8 Set-Up Menu

9 Accessories

10 Appendix

Index



Function		Shooting Mode																									
		C	M	Av	Tv	P	A+	+	*	▲	🌸	👉	📄	🍴	HDR	🌀	👉	👉	📄	👤	📄	📺	📺				
	AEB (📖63)	*1	○	○	○	○	-	-	-	-	-	-	-	-	-	-	-	-	-	-	-	-	-				
	ISO speed (📖62)	ISO Speed	See "Functions Available in Each Shooting Mode" (📖177).																								
		ISO Auto	*1	○	○	○	○	-	-	-	-	-	-	-	-	-	-	-	-	-	-	-	-	○			
	Highlight tone priority (📖64)	*1	○	○	○	○	-	-	-	-	-	-	-	-	-	-	-	-	-	-	-	○	○				
	Auto Lighting Optimizer (📖64)	See "Quick Settings" (📖179).																									
	Metering mode (📖62)	See "Quick Settings" (📖179).																									
📷*6	Flash firing (📖75)		Refer to "Functions Available in Each Shooting Mode" (📖177).																								
	Flash Control	E-TTL II meter. (📖77)	Evaluative/Average	*1	○	○	○	○	-	-	-	-	-	-	-	-	-	-	-	-	-	-	-	-			
		Red-eye reduc. (📖47)	On/Off	*1	○	○	○	○	○	○	○	-	○	-	○	○	-	○	○	○	○	○	○	-	-		
	Built-in flash settings	Flash Mode (📖85)	E-TTL II	*1	○	○	○	○	○	○	○	-	○	-	○	○	-	○	○	○	○	○	○	-	-		
			Manual flash	*1	○	○	○	-	-	-	-	-	-	-	-	-	-	-	-	-	-	-	-	-	-		
		Shutter Sync. (📖77)	1st curtain	*1	○	○	○	○	○	○	○	-	○	-	○	○	-	○	○	○	○	○	○	-	-		
			2nd curtain	*1	○	○	○	○	-	-	○	-	-	-	-	-	-	-	-	-	-	-	-	-	-		
		exp. comp.	See "Functions Available in Each Shooting Mode" (📖177).																								
		External flash func. setting (📖155)	*1	○	○	○	○	-	-	-	-	-	-	-	-	-	-	-	-	-	-	-	-	-			
		External flash C.Fn setting (📖156)	*1	○	○	○	○	-	-	-	-	-	-	-	-	-	-	-	-	-	-	-	-	-			
	Clear settings (📖77, 📖157)	*1	○	○	○	○	-	-	*7	-	-	-	-	-	-	-	-	-	-	-	-	-	-				

Before Use

Basic Guide

Advanced Guide

1 Camera Basics

2 Auto Mode / Hybrid Auto Mode

3 Other Shooting Modes

4 P Mode

5 Tv, Av, M, and C Modes

6 Playback Mode

7 Wi-Fi Functions

8 Set-Up Menu

9 Accessories

10 Appendix

Index



Function		Shooting Mode																					
		C	M	Av	Tv	P	A+	+	*	⬇	⬆	⬇	⬆	⬇	⬆	⬇	⬆	⬇	⬆	⬇	⬆		
4*8	Custom White Balance (📖65)	*1	○	○	○	○	-	-	-	-	-	-	-	-	-	-	-	-	-	-	○	○	
	WB Correction (📖66)	See "Quick Settings" (📖179).																					
	Picture Style (📖67)	See "Quick Settings" (📖179).																					
	High ISO speed NR (📖80)	Standard	*1	○	○	○	○	○	○	○	○	○	○	○	○	○	○	○	○	○	○	○	○
		Disable/ Low/High/ Multi Shot Noise Reduction	*1	○	○	○	○	-	-	-	-	-	-	-	-	-	-	-	-	-	-	-	-
	Long exp. noise reduction (📖81)	Disable	*1	○	○	○	○	○	○	○	○	○	○	○	○	○	○	○	○	○	○	○	○
		Auto/Enable	*1	○	○	○	○	-	-	-	-	-	-	-	-	-	-	-	-	-	-	-	-
	Digest Type (📖37)	Include Stills/No Stills	-	-	-	-	-	-	○	-	-	-	-	-	-	-	-	-	-	-	-	-	
AF auto switch (📖40)	Enable	-	-	-	-	-	○	-	-	-	-	-	-	-	-	-	-	-	-	-	-		
	Disable	○	○	○	○	○	○	○	○	○	○	○	○	○	○	○	○	○	○	○	○	○	
Keep ⚙️ setting (📖48)	Disable/ Enable	-	-	-	-	-	-	-	○	-	-	-	-	-	-	-	-	-	-	-	-	-	

Before Use

Basic Guide

Advanced Guide

1 Camera Basics

2 Auto Mode / Hybrid Auto Mode

3 Other Shooting Modes

4 P Mode

5 Tv, Av, M, and C Modes

6 Playback Mode

7 Wi-Fi Functions

8 Set-Up Menu

9 Accessories

10 Appendix

Index



Function		Shooting Mode		C	M	Av	Tv	P	A+	+	*	▲	■	✎	☰	HDR	⌂	✎	✎	☰	👤	☰	📺	📺			
		Movie rec. size (📄45)	See "Quick Settings" (📄179).																								
📷 5	Sound Recording (📄59)	Sound recording	Auto/Enable	*1	○	○	○	○	○	○	○	○	○	○	○	○	○	○	○	○	○	○	○	○	○	○	
			Manual	*1	○	○	○	○	–	–	–	–	–	–	–	–	–	–	–	–	–	–	–	–	○	○	
			Disable	*1	○	○	○	○	○	○	○	○	○	○	○	○	○	○	○	○	○	○	○	○	○	○	○
	Wind filter/ Attenuator	Wind Filter	Auto	*1	○	○	○	○	○	○	○	○	○	○	○	○	○	○	○	○	○	○	○	○	○	○	○
			Off	*1	○	○	○	○	–	–	–	–	–	–	–	–	–	–	–	–	–	–	○	○	○	○	
		Attenuator	Off	*1	○	○	○	○	○	○	○	○	○	○	○	○	○	○	○	○	○	○	○	○	○	○	○
	On		*1	○	○	○	○	–	–	–	–	–	–	–	–	–	–	–	–	–	–	–	–	○	○		
	Movie Servo AF (📄57)	Enable	*1	○	○	○	○	○	○	○	○	○	○	○	○	○	○	○	○	○	○	○	○	○	○	○	
		Disable	*1	○	○	○	○	○	○	○	○	○	○	○	○	○	○	○	○	○	○	○	○	○	○	○	
	AF w/ shutter button during (📄58)	ONE SHOT/Disable	*1	○	○	○	○	○	○	○	○	○	○	○	○	○	○	○	○	○	○	○	○	○	○	○	

*1 Adjustable content depends on added shooting modes.
 *2 Locked at [OFF] when [📄] and [SERVO] are both selected.
 *3 Only displayed when the Electronic Viewfinder is attached.
 *4 Not displayed when using EF lens, EF-S lens or EF-M lens without image stabilization.
 *5 Only displayed when using a lens that supports dynamic image stabilization.
 *6 In [HDR] mode, items from the [📷5] tab are shown on the [📷3] tab.
 *7 [Clear built-in flash set.] only.
 *8 In [📷1], [📷2], [📷3], [📷4], [📷5], [📷6], [📷7], [📷8], [📷9], [📷10] and [📷11] modes, items from the [📷5] tab are shown on the [📷4] tab.

○ Selectable or set automatically. – Not selectable.

- Before Use
- Basic Guide
- Advanced Guide
 - 1 Camera Basics
 - 2 Auto Mode / Hybrid Auto Mode
 - 3 Other Shooting Modes
 - 4 P Mode
 - 5 Tv, Av, M, and C Modes
 - 6 Playback Mode
 - 7 Wi-Fi Functions
 - 8 Set-Up Menu
 - 9 Accessories
 - 10 Appendix
- Index



C.Fn Tab

Function			Shooting Mode																											
			C	M	Av	Tv	P	A+	+	+	+	+	+	+	+	+	HDR	+	+	+	+	+	+	+	+	+	+	+	+	
C.Fn I: Exposure (88)	ISO expansion	0:Off	*	O	O	O	O	O	O	O	O	O	O	O	O	O	O	O	O	O	O	O	O	O	O	O	O	O	O	
		1:On	*	O	O	O	O	-	-	-	-	-	-	-	-	-	-	-	-	-	-	-	-	-	-	-	-	-	O	
	Safety shift	0:Off	*	O	O	O	O	O	O	O	O	O	O	O	O	O	O	O	O	O	O	O	O	O	O	O	O	O	O	O
		1:On	*	-	O	O	-	-	-	-	-	-	-	-	-	-	-	-	-	-	-	-	-	-	-	-	-	-	-	-
C.Fn II: Autofocus (88)	AF-assist beam (LED) firing	0:Enable	*	O	O	O	O	O	-	O	O	O	O	-	O	O	O	O	O	O	O	O	O	O	O	O	O	O	O	
		1:Disable	*	O	O	O	O	-	O	-	-	-	-	O	-	-	-	-	-	-	-	-	-	-	-	-	-	O	O	
C.Fn III: Others (88)	Custom Controls	Shutter/AE lock	*	O	O	O	O	-	-	-	-	-	-	-	-	-	-	-	-	-	-	-	-	-	-	-	-	O	O	
		Dials	*	O	O	O	O	-	-	-	-	-	-	-	-	-	-	-	-	-	-	-	-	-	-	-	-	-	O	O
		M-Fn button	*	O	O	O	O	-	-	-	-	-	-	-	-	-	-	-	-	-	-	-	-	-	-	-	-	-	O	O
		button	*	O	O	O	O	-	-	-	-	-	-	-	-	-	-	-	-	-	-	-	-	-	-	-	-	-	O	O
		button	*	O	O	O	O	-	-	-	-	-	-	-	-	-	-	-	-	-	-	-	-	-	-	-	-	-	-	-
	Release shutter w/o lens	0:Disable	*	O	O	O	O	O	O	O	O	O	O	O	O	O	O	O	O	O	O	O	O	O	O	O	O	O	O	O
		1:Enable	*	O	O	O	O	-	-	-	-	-	-	-	-	-	-	-	-	-	-	-	-	-	-	-	-	-	O	O
	Retract lens on power off	0:Enable	*	O	O	O	O	O	O	O	O	O	O	O	O	O	O	O	O	O	O	O	O	O	O	O	O	O	O	O
		1:Disable	*	O	O	O	O	-	-	-	-	-	-	-	-	-	-	-	-	-	-	-	-	-	-	-	-	-	O	O
	Clear all Custom Func. (C.Fn) (89)			*	O	O	O	O	-	-	-	-	-	-	-	-	-	-	-	-	-	-	-	-	-	-	-	-	O	O

* Adjustable content depends on added shooting modes.

O Selectable or set automatically. – Not selectable.

Before Use

Basic Guide

Advanced Guide

1 Camera Basics

2 Auto Mode / Hybrid Auto Mode

3 Other Shooting Modes

4 P Mode

5 Tv, Av, M, and C Modes

6 Playback Mode

7 Wi-Fi Functions

8 Set-Up Menu

9 Accessories

10 Appendix

Index



My Menu Tab

Tabs	Item	Ref. Page
★1	My Menu settings	📖91

Playback Tab

Tabs	Item	Ref. Page
▶1	Protect	📖102
	Rotate	📖107
	Erase	📖105
	Rating	📖108
	Slideshow	📖101
	List/Play Digest Movies	📖96
	Image Search	📖98
▶2	Creative filters	📖111
	Resize	📖109
	Cropping	📖110
	Red-Eye Correction	📖112
	Print settings	📖161
Photobook Set-up	📖166	
▶3	Transition Effect	📖94
	Index Effect	📖97
	Scroll Display	📖94
	Auto Rotate	📖108
	Resume	📖94
▶4	Playback information display	📖95
	Magnify (approx.)	📖100

Playback Mode Quick Settings

Item	Ref. Page
Protect	📖102
Rotate	📖107
Rating	📖108
Image Search	📖98
Play Movie	📖94
Play Linked Digest Movie	📖96
Print	📖160
Resize	📖109
Cropping	📖110
Creative filters	📖111
Apply settings to 	📖50

Before Use

Basic Guide

Advanced Guide

1 Camera Basics

2 Auto Mode / Hybrid Auto Mode

3 Other Shooting Modes

4 P Mode

5 Tv, Av, M, and C Modes

6 Playback Mode

7 Wi-Fi Functions

8 Set-Up Menu

9 Accessories

10 Appendix

Index



Handling Precautions

- The camera is a high-precision electronic device. Avoid dropping it or subjecting it to strong impact.
- Never leave the camera near anything that has a strong magnetic field such as a magnet or electric motor. Strong magnetic fields can cause camera malfunction or image data loss.
- If water droplets or dirt adheres to the camera or screen, wipe with a dry soft cloth, such as an eyeglass cloth. Do not rub hard or apply force.
- Never use cleaners containing organic solvents to clean the camera or screen.
- Use a blower brush to remove dust from the lens. If cleaning is difficult, contact a Canon Customer Support Help Desk.
- If the camera is suddenly brought in from the cold into a warm room, condensation may form on the camera. To prevent condensation, first put the camera in a sealed plastic bag and let it adjust to the warmer temperature before taking it out of the bag.
- Store the battery inside a sealed plastic bag or other protective covering. To preserve battery function, if it is not used for long periods of time, recharge around once per year, then use up the charge completely before placing in storage.
- If condensation does form on the camera, stop using it immediately. Continuing to use the camera in this state may damage it. Remove the lens, battery pack and memory card, and wait until the moisture has evaporated before resuming use.
- Do not touch the camera or lens contacts. Doing so may lead to camera malfunction.
- The image sensor is visible after the lens is removed. Do not touch the image sensor, as this may lead to scratching.
- Do not block the shutter operation with your finger, etc. Doing so may cause a malfunction.
- After detaching the lens from the camera, put down the lens with the rear end up and attach the lens caps to avoid scratching the lens surface and contacts.

- Besides dust entering the camera from outside, in rare cases lubricant from the camera's internal parts may adhere to the front of the sensor. If visible spots still remain after the automatic sensor cleaning, having the sensor cleaned by a Canon Service Center is recommended.
- Periodically cleaning the camera's body and lens mount with a soft lens cleaning cloth is recommended.

Before Use

Basic Guide

Advanced Guide

1 Camera Basics

2 Auto Mode / Hybrid Auto Mode

3 Other Shooting Modes

4 P Mode

5 Tv, Av, M, and C Modes

6 Playback Mode

7 Wi-Fi Functions

8 Set-Up Menu

9 Accessories

10 Appendix

Index



Specifications

Type

Type	Digital single-lens non-reflex AF/AE camera
Recording media	SD memory card, SDHC memory card, SDXC memory card * Compatible with UHS-I
Image sensor size	Approx. 22.3 × 14.9 mm
Compatible lenses	Canon EF-M, EF*, and EF-S* lenses * Mount Adapter EF-EOS M required. (35mm film equivalent focal length is approx. 1.6 times the lens focal length)
Lens mount	Canon EF-M mount

Image Sensor

Type	CMOS sensor
Effective pixels	Approx. 24.2 million pixels
Total pixels	Approx. 24.7 million pixels
Aspect ratio	3:2
Dust cleaning feature	Automatically or manually executed when turned on/off

Recording System

Recording format	Design rule for Camera File System (DCF) 2.0
Image type	JPEG, RAW (14-bit Canon original) RAW+JPEG Simultaneous recording possible
Resolution	L (Large): Approx. 24 megapixels (6000 x 4000) M (Medium): Approx. 12.40 megapixels (4320 x 2880) S1 (Small 1): Approx. 5.50 megapixels (2880 x 1920) S2 (Small 2): Approx. 3.50 megapixels (2304 x 1536) S3 (Small 3): Approx. 350,000 pixels (720 x 480) RAW: Approx. 24 megapixels (6000 x 4000)

Before Use

Basic Guide

Advanced Guide

1 Camera Basics

2 Auto Mode / Hybrid Auto Mode

3 Other Shooting Modes

4 P Mode

5 Tv, Av, M, and C Modes

6 Playback Mode

7 Wi-Fi Functions

8 Set-Up Menu

9 Accessories

10 Appendix

Index



Image Processing during Shooting

Picture Style	Auto, Standard, Portrait, Landscape, Neutral, Faithful, Monochrome, User Def. 1 - 3
White balance	Auto, Preset (Daylight, Shade, Cloudy, Tungsten light, White fluorescent light, Flash), Custom white balance correction feature available *Flash color temperature information transmission enabled
Noise reduction	Applicable to long exposures and high ISO speed shots
Automatic image brightness correction	Auto Lighting Optimizer
Highlight tone priority	Provided
Lens aberration correction	Peripheral illumin., Chromatic aberration

Autofocus

Type	Hybrid CMOS AF III method (1-point AF, face + tracking priority AF)
AF points	49 points (Max.)
Focusing brightness range	EV 2 - 18 (at room temperature, ISO 100)
AF operation	One-Shot AF, Servo AF
AF-assist beam	Built-in (LED lamp)

Exposure Control

Metering modes	Real-time metering with image sensor Evaluative metering (384 zones), Partial metering (approx. 10 % of shooting screen), Spot metering (approx. 2 % of shooting screen), Center Weighted Avg.
Brightness metering range	EV 1 - 20 (at room temperature, ISO 100)
Exposure control	Program AE, Shutter priority AE, Aperture priority AE, Manual exposure
ISO speed (Recommended exposure index)	Manually set ISO 100 – 12800, equivalent to 25600 when expanded Automatic setting possible
Exposure compensation	Manual: ± 3 stops in 1/3-stop increments AEB: ± 2 stops in 1/3-stop increments (can be combined with manual exposure compensation)
AE lock	Auto: Applied in One-Shot AF with evaluative metering when focus is achieved Manual: With AE lock button

Before Use

Basic Guide

Advanced Guide

1 Camera Basics

2 Auto Mode / Hybrid Auto Mode

3 Other Shooting Modes

4 P Mode

5 Tv, Av, M, and C Modes

6 Playback Mode

7 Wi-Fi Functions

8 Set-Up Menu

9 Accessories

10 Appendix

Index



Shutter

Type	Electronically controlled, focal-plane shutter
Shutter speed	1/4000 sec. to 30 sec. (Total shutter speed range; available range varies by shooting mode), Bulb, X-sync at 1/200 sec.

Flash

Built-in Flash	Retracting, manual pop-up flash Guide number approx. 5 (ISO 100/m) Supports angle of view equivalent to focal length of approx. 18 mm (35mm film equivalent: approx. 29 mm) Recharging time approx. 3 sec.
External flash	EX-series Speedlites (Flash functions can be set with the camera)
Flash metering mode	E-TTL II autofocus
Flash exposure compensation	±2 stops in 1/3-stop increments
FE lock	Provided
PC terminal	None

Drive, Self-timer System

Drive mode	Single shooting, continuous shooting
Continuous shooting speed	Max. 4.2 fps
Max. burst	JPEG: Approx. 1000 images RAW: Approx. 5 images RAW+ JPEG Large/Fine: Approx. 4 images *Measured by Canon testing standards (ISO 100, Picture Style: using standard settings), using a 16 GB UHS-I memory card, which complies with Canon testing standards.
Self-timer mode	Off/2-second self-timer/10-second self-timer/ Remote control

Still Photo Shooting

Aspect ratio settings	3:2, 4:3, 16:9, 1:1
Focus mode	AF, MF (manual focusing, approx. 5x / 10x magnification possible), AF+MF
Continuous AF	Provided
Touch shutter	Provided
Grid display	Two types
Creative Filters	Included as a shooting mode
Depth-of-field preview	Provided

Movie Shooting Settings

Recording System	MP4
Movie	MPEG-4 AVC/H.264 Variable (average) bit rate
Audio	MPEG-4 AAC-LC
Recording size and frame rate	1920x1080 (Full HD): 29.97fps (NTSC) / 23.98fps* (NTSC) / 25.00fps (PAL) 1280x720 (HD): 59.94fps (NTSC) / 50.00fps (PAL) 640x480 (SD): 29.97fps (NTSC) / 25.00fps (PAL) *The actual frame rate is; 23.976fps
File size	1920 x 1080 (29.97 fps/23.98 fps/25.00 fps): 172.6 MB/min. 1280 x 720 (59.94 fps/50.00 fps): 115.4 MB/min. 640 x 480 (29.97 fps/25.00 fps): 22.4 MB/min.
Focusing	Hybrid CMOS AF III method* (1-point AF, face + tracking priority AF) Manual focus *Focusing brightness range: EV 2 - 18 (at room temperature, ISO 100)
Focus mode	AF, MF (manual focusing), AF+MF
Metering modes	Evaluative

Before Use

Basic Guide

Advanced Guide

1 Camera Basics

2 Auto Mode / Hybrid Auto Mode

3 Other Shooting Modes

4 P Mode

5 Tv, Av, M, and C Modes

6 Playback Mode

7 Wi-Fi Functions

8 Set-Up Menu

9 Accessories

10 Appendix

Index



Servo AF	Provided
Brightness metering range	EV 1 - 20 (at room temperature, ISO 100)
Exposure control	Program AE for movies and manual exposure
Exposure compensation	±3 stops in 1/3-stop increments
ISO speed (Recommended exposure index)	With automatic exposure: ISO 100 - 3200 (Full HD) / ISO 100 - 6400 (HD/SD) set automatically With manual exposure: ISO 100 - 3200 (Full HD) / ISO 100 - 6400 (HD/SD) set automatically/ manually, H (ISO 6400 (Full HD) / ISO 12800 (HD/SD) equivalent) speed possible
Miniature effect movie	Provided
Sound recording	Built-in stereo microphone External stereo microphone terminal provided Audio recording level adjustable, wind filter (for built-in microphone) provided, attenuator provided
Grid display	Two types

LCD Monitor

Type	TFT color, liquid-crystal monitor
Monitor size and dots	Wide, 7.7 cm (3.0 in.) (3:2) with approx. 1.04 million dots
Angle adjustment	Provided
Brightness adjustment	Manual (5 levels)
Interface languages	25 languages
Hints & Tips	Displayable

Playback

Image display formats	Single image display, Single image + Info display (Basic info, shooting info, histogram, lens info, Picture Style, noise reduction, and correction data), image index (6/12/42/110), image rotate possible
Zoom magnification	Approx. 1.5x - 10x
Highlight alert	Overexposed highlights blink
Image browsing methods	Single image, jump by 10 or 100 images, filter images (by shooting date, by people, by movies, by stills, by rating), Scroll Display
Image rotate	Provided
Rating	Provided
Movie playback	Enabled (LCD monitor, HDMI OUT) Built-in speaker
Protect images	Provided
Slideshow	All images/Filter images by image search Transition effect: Off/Fade

Post-processing of Images

Possible only with images taken with the same model

Creative filters	Grainy B/W, Soft focus, Fish-eye effect, Art bold effect, Water painting effect, Toy camera effect, Miniature effect
Resize	Provided
Red-Eye Correction	Provided

Before Use

Basic Guide

Advanced Guide

1 Camera Basics

2 Auto Mode / Hybrid Auto Mode

3 Other Shooting Modes

4 P Mode

5 Tv, Av, M, and C Modes

6 Playback Mode

7 Wi-Fi Functions

8 Set-Up Menu

9 Accessories

10 Appendix

Index



Direct Printing

Type	PictBridge (USB and Wireless LAN)
Printable images	JPEG and RAW images (Can print RAW images displayed as JPEG only with images taken with the same model)
Print ordering	DPOF Version 1.1 compatible

Custom Functions

Custom Functions	6 types
My Menu registration	Provided
Copyright Info	Entry and inclusion possible

Interface

Digital terminal	PC networking for direct print (Hi-Speed USB equivalent)
HDMI mini OUT terminal	Type C (auto-switching of resolution)
External microphone IN terminal	3.5 mm diameter stereo mini-jack
Wireless remote control	Compatible with Remote Controller RC-6

Wi-Fi

Standards compliance	IEEE 802.11b/g/n
Transmission Methods	DS-SS modulation (IEEE 802.11b) OFDM modulation (IEEE 802.11g/n)
Transmission range	Approx. 15 m (49.21 ft.) *When connected to a smartphone *With no obstructions between the transmitting and receiving antennas and no radio interference
Transmission frequency (central frequency)	Frequency: 2412 to 2462 MHz Channels: 1 to 11 ch
Connection method	Infrastructure mode*, camera access point mode, ad hoc mode *Wi-Fi Protected Setup supported
Security	Authentication method: Open system, Shared key, WPA-PSK, WPA2-PSK Encryption: WEP, TKIP, AES

Network Functions

Transfer images between cameras	Transferring one image, Transferring selected images, Transferring resized images
Connection to smartphones	Viewing/controlling/receiving images using a smartphone Sending images to a smartphone connected via NFC Remote control of the camera using a smartphone.
Print from Wi-Fi printers	Images to be printed can be sent to a printer supporting Wi-Fi.
Send images to a Web service	Images in the camera or links to images can be sent to registered Web services.
View images using a media player	Images can be viewed using a DLNA-compatible media player.

Before Use

Basic Guide

Advanced Guide

1 Camera Basics

2 Auto Mode / Hybrid Auto Mode

3 Other Shooting Modes

4 P Mode

5 Tv, Av, M, and C Modes

6 Playback Mode

7 Wi-Fi Functions

8 Set-Up Menu

9 Accessories

10 Appendix

Index



Power Supplies

Battery	Battery Pack LP-E17 (Quantity 1) *AC power can be supplied via AC Adapter Kit ACK-E17
Number of possible shots (Based on CIPA testing standards)	Room temperature (23°C) Approx. 250 images / Low temperature (0°C) Approx. 185 images
Movie shooting time	Room temperature (23°C) Approx. 1 h 40 min. / Low temperature (0°C) Approx. 1 h 35 min. (When using fully charged Battery Pack LP-E17)

Dimensions and Weight









Dimensions (W x H x D)	Approx. 110.9 x 68.0 x 44.4 mm (4.4 x 2.7 x 1.7 in.)
Weight	Approx. 366 g (12.9 oz.) (Based on CIPA Guidelines: includes camera body + battery pack + card) Approx. 319 g (11.3 oz.) (camera body only, excluding the lens cap)

Operation Environment

Working temperature range	0°C - 40°C
Working humidity	85% or less

Number of Shots per Memory Card

Using a 16 GB memory card

Image Quality	File Size (Approx. MB)	Recordable Shots (Approx.)	Maximum Burst (Approx.)
	9.0	1680	1000
	5.8	2612	1000
	5.8	2612	1000
	3.6	4152	1000
	3.0	5061	1000
	2.0	7592	1000
	1.8	8377	1000
	0.3	48592	1000
	30.2	500	5
RAW + JPEG	Total size of RAW + JPEG	385	4

- The values of the file size, recordable shots, and maximum burst were measured using a Canon's testing standard 16 GB memory card and based on the testing standards (the aspect ratio of 3:2, ISO100, and the picture style set to Standard). These values may vary depending on conditions.
- The values of the maximum burst were measured using a 16 GB UHS-I memory card.

Before Use

Basic Guide

Advanced Guide

1 Camera Basics

2 Auto Mode / Hybrid Auto Mode

3 Other Shooting Modes

4 P Mode

5 Tv, Av, M, and C Modes

6 Playback Mode

7 Wi-Fi Functions

8 Set-Up Menu

9 Accessories



10 Appendix

Index



Recording Time per Memory Card

Using a 16 GB memory card

Image Quality	File Size (Approx. MB)	Total Recording Time (Approx.)
	172.6 MB/minute	1 hour 26 minutes 5 seconds
	115.4 MB/minute	2 hours 8 minutes 27 seconds
	22.4 MB/minute	10 hours 22 minutes 35 seconds

- Continuous shooting is possible until either the memory card reaches its limit or the recording time reaches 29 minutes 59 seconds.
- Recording may stop even if the limit of 29 minutes 59 seconds has not been reached on some memory cards. SD Speed Class 4 or higher memory cards are recommended. Faster memory cards are required when shooting stills while recording a movie.

Internal Flash Range Guide

(approx. - m)

ISO speed	When EF-M18-55mm f/3.5-5.6 IS STM is Attached	
	Wide-angle: f/3.5	Telephoto: f/5.6
100	0.5 - 1.4	0.5 - 0.9
200	0.5 - 2.0	0.5 - 1.3
400	0.5 - 2.9	0.5 - 1.8
800	0.7 - 4.0	0.5 - 2.5
1600	1.0 - 5.7	0.6 - 3.6
3200	1.5 - 8.1	0.9 - 5.1
6400	2.1 - 11.4	1.3 - 7.1
12800	2.9 - 16.2	1.8 - 10.1
H (equivalent to 25600)	4.1 - 22.9	2.6 - 14.3

Battery Pack LP-E17

Type	Rechargeable lithium-ion battery
Rated voltage	7.2 V DC
Battery capacity	1040 mAh
Working temperature range	Charging: 5°C - 40°C Shooting: 0°C - 40°C
Working humidity	85% or less
Dimensions (W x H x D)	Approx. 33.0 x 14.0 x 49.4 mm (1.30 x 0.55 x 1.94 in.)
Weight	Approx. 45 g (1.59 oz.) (excluding protective cover)

Before Use

Basic Guide

Advanced Guide

1 Camera Basics

2 Auto Mode / Hybrid Auto Mode

3 Other Shooting Modes

4 P Mode

5 Tv, Av, M, and C Modes

6 Playback Mode

7 Wi-Fi Functions

8 Set-Up Menu

9 Accessories

10 Appendix

Index



Battery Charger LC-E17/LC-E17E

Compatible battery	Battery Pack LP-E17
Recharging time	Approx. 2 hours (at room temperature)
Rated input	100 - 240 V AC (50/60 Hz)
Rated output	8.4 V DC / 700mA
Working temperature range	5°C - 40°C
Working humidity	85% or less
Dimensions (W x H x D)	Approx. 67.3 x 27.7 x 92.2 mm (2.65 x 1.09 x 3.63 in.)
Weight	LC-E17: Approx. 85 g (3.00 oz.) LC-E17E: Approx. 80 g (2.82 oz.) (excluding power cord)

- All the data above is based on Canon's testing standards and CIPA (Camera & Imaging Products Association) testing standards and guidelines.
- Dimensions, maximum diameter, length and weight listed above are based on CIPA Guidelines (except weight for camera body only).
- Product specifications and the exterior are subject to change without notice.
- If a problem occurs with a non-Canon lens attached to the camera, consult the respective lens manufacturer.

Before Use

Basic Guide

Advanced Guide

1 Camera Basics

2 Auto Mode / Hybrid Auto Mode

3 Other Shooting Modes

4 P Mode

5 Tv, Av, M, and C Modes

6 Playback Mode

7 Wi-Fi Functions

8 Set-Up Menu

9 Accessories

10 Appendix

Index



Index

Numbers

1-point (AF frame mode) 69

A

AC adapter kit 148, 151
Accessories 148
AEB shooting 63
AE Lock 61
AF frames 69
AF lock 71
AF-point zoom 74
Art bold effect (shooting mode)
54
Aspect ratio 45
Auto Lighting Optimizer 64
Auto mode (shooting mode) 23
AUTO mode (shooting mode) 35
Auto rotate 108
Av (shooting mode) 83

B

Batteries → Date/time (date/time
battery)
Power saving 28
Battery charger 2, 148
Battery pack
Charging 16
Eco Mode 139
Level 174
Power saving 28
Black and white images 57
BULB (Bulb exposure) 85
B/W (Monochrome) 67

C

Camera
Reset all 145
Camera access point mode 122
Camera shake 23
CANON IMAGE GATEWAY 122
Charging 17
Chromatic aberration 79
Cleaning (image sensor) 142
Close-up (shooting mode) 51
Color temperature 66
Color (white balance) 65
Compression ratio 43
Contrast 68
Creative Assist (shooting mode) 48
Creative filters (shooting mode) 52
Cropping 110, 162
C (shooting mode) 88
Custom Functions 88
Custom WB 65
Custom white balance 65

D

Date/time
Changing 19
Date/time battery 19
Settings 18
World clock 141
DC coupler 151
Defaults → Clear settings
Direct printing 194
Display language 20
Display period 49
DLNA 115
DPOF 164

E

Eco Mode 139
Editing
Cropping 110
Red-eye correction 112
Resizing images 109
Editing or erasing connection
informationEditing or erasing
connection information 116
Erasing 105
Erasing all 106
Error messages 172
Exposure
AE lock 61
Compensation 61
FE lock 76
F
Face+Tracking AF 70
Faithful 67
Favorites 108
FEB 156
FE Lock 76
File numbering 137
Filter effects 68
Firmware 145
First-curtain synchronization 156
Fish-eye effect (shooting mode) 54
Flash
Flash exposure compensation 76
Flash off 75
On 75
Slow synchro 75
Flash exposure compensation 76
Flash Mode 155
Flash off 75
Focusing
AF frames 69

AF lock 71
MF peaking 74
Servo AF 72
Touch AF 71
Focusing Range
Manual focus 74
Focus lock 70
Food (shooting mode) 52

G

Grainy B/W (shooting mode) 57
Grid lines 30

H

Handheld nightscene (shooting mode)
51
HDMI cable 150
High dynamic range (shooting mode)
53
High ISO speed noise reduction 80
Household power 151
Hybrid Auto (shooting mode) 37

I

Icons 174, 175
Image dust prevention 142
Image quality → Compression ratio
(image quality)
Images
Display period 47
Erasing 105
Playback → Viewing
Protecting 102
Image stabilization 78
Image Sync 131
Index display 97
Indicator 34, 47
Installation 134, 158
ISO speed 62

Before Use

Basic Guide

Advanced Guide

1 Camera Basics

2 Auto Mode / Hybrid Auto Mode

3 Other Shooting Modes

4 P Mode

5 Tv, Av, M, and C Modes

6 Playback Mode

7 Wi-Fi Functions

8 Set-Up Menu

9 Accessories

10 Appendix

Index



J

Jump display 99

L

Landscape 67
Landscape (shooting mode) 51
Lens 20
 Lock release 21
Level 174
Long exposure noise reduction 81

M

M (shooting mode) 84
Macro photography 51
Magnified display 100
Main Dial 3
Manual focus 74
Memory cards 2
Menu
 Basic operations 32
 Table 177
Metering method 62
MF (manual focusing) 74
MF peaking 74
Miniature effect (shooting mode) 55
Movies
 Editing 113
 Image quality (resolution/frame rate) 43
Multi Shot Noise Reduction 80

N

Neck strap → Strap
Neutral 67
Noise reduction
 High ISO speed 80
 Long exposure 81
Nomenclature 3

O

On 75

P

P (shooting mode) 60
Package contents 2
Peripheral illumination correction 79
Photobook set-up 166
PictBridge 150, 160
Picture Style 67
Playback → Viewing
Portrait (shooting mode) 51
Power 148 → AC adapter kit,
 → Battery charger, → Battery pack
Power saving 28
Printing 160 → Print
Program AE 60
Protecting 102

Q

Q menu → Quick Setting menu
Quick Setting menu
 Basic operations 31
 Table 179

R

Rating 108
RAW 43
Red-eye correction 112
Remote shooting 133
Reset all 145
Resizing images 109
Resolution (image size) 43
Rotating 107

S

Saturation 68
Saving images to a computer 132,
 159
Screen
 Display language 20
 Icons 174, 175
 Menu → Quick Setting menu,
 Menu
SD/SDHC/SDXC memory cards
 → Memory cards
Searching 98
Second-curtain synchronization 156
Self-timer 40
 2-second self-timer 41
Sending images 122
Sending images to another camera
 129
Sending images to a printer 132
Sending images to Web services 125
Sensor cleaning 142
Servo AF 72
Sharpness 68
Shooting
 Shooting information 174
Single-image display 25
Slideshow 101
Slow synchro 75
Soft focus (shooting mode) 56
Software
 Installation 158
 Saving images to a computer
 132, 159
Sounds 137
Sports (shooting mode) 51
Strap 16

T

Terminal 150, 151, 160

Tone priority 64
Toning effect 68
Touch AF 71
Touch screen 3
Touch shutter 41
Toy camera effect (shooting mode)
 56
Traveling with the camera 141
Tripod socket 3
Troubleshooting 168
TV display 150
Tv (shooting mode) 82

V

Viewing 25
 Image search 98
 Index display 97
 Jump to image 99
 Magnified display 100
 Single-image display 25
 Slideshow 101
 TV display 150

W

Water painting effect (shooting mode)
 54
White balance (color) 65
Wi-Fi functions 115
Wireless flash shooting 155
World clock 141
Wrist strap → Strap

Z

Zoom 23

Before Use

Basic Guide

Advanced Guide

1 Camera Basics

2 Auto Mode / Hybrid Auto Mode

3 Other Shooting Modes

4 P Mode

5 Tv, Av, M, and C Modes

6 Playback Mode

7 Wi-Fi Functions

8 Set-Up Menu

9 Accessories

10 Appendix

Index



Wi-Fi (Wireless LAN) Precautions

- The model number is PC2064 (including WLAN module model WM223).
- Countries and Regions Permitting WLAN Use
 - Use of WLAN is restricted in some countries and regions, and illegal use may be punishable under national or local regulations. To avoid violating WLAN regulations, visit the Canon website to check where use is allowed.
 - Note that Canon cannot be held liable for any problems arising from WLAN use in other countries and regions.
- Doing any of the following may incur legal penalties:
 - Altering or modifying the product
 - Removing the certification labels from the product
- According to foreign exchange and foreign trade law regulations, export permission (or service transaction permission) from the Japanese government is necessary to export strategic resources or services (including this product) outside Japan.
- Because this product includes American encryption software, it falls under U.S. Export Administration Regulations, and cannot be exported to or brought into a country under U.S. trade embargo.
- Be sure to make notes of the wireless LAN settings you use. The wireless LAN settings saved to this product may change or be erased due to incorrect operation of the product, the effects of radio waves or static electricity, or accident or malfunction. Be sure to make notes of wireless LAN settings as a precaution. Please note that Canon accepts no responsibility for direct or indirect damages or loss of earnings resulting from a degradation or disappearance of content.
- When transferring this product to another person, disposing of it, or sending it for repair, be sure to note the wireless LAN settings and reset the product to its default settings (erase settings) if necessary.
- Canon will not make compensation for damages resulting from loss or theft of the product. Canon accepts no responsibility for damages or loss resulting from unauthorized access or use of target devices registered on this product due to loss or theft of the product.

- Be sure to use the product as directed in this guide. Be sure to use the wireless LAN function of this product within the guidelines noted in this guide. Canon accepts no responsibility for damages or loss if the function and product are used in ways other than as described in this guide.
- Do not use the wireless LAN function of this product near medical equipment or other electronic equipment. Use of the wireless LAN function near medical equipment or other electronic equipment may affect operation of those devices.

Radio Wave Interference Precautions

- This product may receive interference from other devices that emit radio waves. To avoid interference, be sure to use this product as far away as possible from such devices, or avoid using the devices at the same time as this product.

Security Precautions

Because Wi-Fi uses radio waves to transmit signals, security precautions more stringent than when using a LAN cable are required. Keep the following points in mind when using Wi-Fi.

- Only use networks you are authorized to use. This product searches for Wi-Fi networks in the vicinity and displays the results on the screen. Networks you are not authorized to use (unknown networks) may also be displayed. However, attempting to connect to or using such networks could be regarded as unauthorized access. Be sure to use only networks you are authorized to use, and do not attempt to connect to other unknown networks.

If security settings have not been properly set, the following problems may occur.

- Transmission monitoring
Third parties with malicious intent may monitor Wi-Fi transmissions and attempt to acquire the data you are sending.

Before Use

Basic Guide

Advanced Guide

1 Camera Basics

2 Auto Mode / Hybrid Auto Mode

3 Other Shooting Modes

4 P Mode

5 Tv, Av, M, and C Modes

6 Playback Mode

7 Wi-Fi Functions

8 Set-Up Menu

9 Accessories

10 Appendix

Index



- **Unauthorized network access**
Third parties with malicious intent may gain unauthorized access to the network you are using to steal, modify, or destroy information. Additionally, you could fall victim to other types of unauthorized access such as impersonation (where someone assumes an identity to gain access to unauthorized information) or springboard attacks (where someone gains unauthorized access to your network as a springboard to cover their tracks when infiltrating other systems).

To prevent these types of problems from occurring, be sure to thoroughly secure your Wi-Fi network.

Only use this camera's Wi-Fi function with a proper understanding of Wi-Fi security, and balance risk and convenience when adjusting security settings.



The camera can print to PictBridge-compatible printers via Wi-Fi. PictBridge technical standards make it easy to connect digital cameras, printers, and other devices directly. Additionally, a new standard called DPS over IP enables PictBridge connections in network environments, and the camera is also compatible with this standard.

Trademarks and Licensing

- DCF is a group trademark and Japanese registered trademark of the Japan Electronics and Information Technology Industries Association.
- Microsoft and Windows are trademarks or registered trademarks of Microsoft Corporation in the United States and/or other countries.
- Macintosh and Mac OS are trademarks of Apple Inc., registered in the U.S. and other countries.
- App Store, iPhone, and iPad are trademarks of Apple Inc.
- The SDXC logo is a trademark of SD-3C, LLC.
- HDMI, the HDMI logo and High-Definition Multimedia Interface are trademarks or registered trademarks of HDMI Licensing, LLC.
- Wi-Fi®, Wi-Fi Alliance®, WPA™, WPA2™ and Wi-Fi Protected Setup™ are trademarks or registered trademarks of the Wi-Fi Alliance.

- The N-Mark is a trademark or registered trademark of NFC Forum, Inc. in the United States and in other countries.
- All other trademarks are the property of their respective owners.
- This device incorporates exFAT technology licensed from Microsoft.
- This product is licensed under AT&T patents for the MPEG-4 standard and may be used for encoding MPEG-4 compliant video and/or decoding MPEG-4 compliant video that was encoded only (1) for a personal and non-commercial purpose or (2) by a video provider licensed under the AT&T patents to provide MPEG-4 compliant video. No license is granted or implied for any other use for MPEG-4 standard.

Disclaimer

- Unauthorized reproduction of this guide is prohibited.
- All measurements based on Canon testing standards.
- Information subject to change without notice, as are product specifications and appearance.
- Illustrations and screenshots in this guide may differ slightly from the actual equipment.
- The above items notwithstanding, Canon cannot be held liable for any loss arising from the use of this product.

All lenses and accessories mentioned in this instruction manual are current as of September 2014. Consult the Customer Service Center for usage with lenses and accessories released after that date.

Before Use

Basic Guide

Advanced Guide

1 Camera Basics

2 Auto Mode / Hybrid Auto Mode

3 Other Shooting Modes

4 P Mode

5 Tv, Av, M, and C Modes

6 Playback Mode

7 Wi-Fi Functions

8 Set-Up Menu

9 Accessories

10 Appendix

Index

