

BDL6520EL



www.philips.com/welcome

User Manual (English)

PHILIPS

Safety Instructions

Warnings and Precautions

KNOW THESE SAFETY SYMBOLS



CAUTION: TO REDUCE THE RISK OF ELECTRIC SHOCK, DO NOT REMOVE COVER (OR BACK). NO USER SERVICEABLE PARTS INSIDE. REFER SERVICING TO QUALIFIED SERVICE PERSONNEL.



This symbol indicates high voltage is present inside. It is dangerous to make any kind of contact with any inside part of this product.



This symbol alerts you that important literature concerning operation and maintenance has been included with this product.

Note to CATV system installers: This reminder is provided to call CATV system installer's attention to Article 820-40 of the National Electrical Code (Section 54 of Canadian Electrical Code, Part I), that provides guidelines for proper grounding and, in particular, specifies that the cable ground shall be connected to the grounding system of the building as close to the point of cable entry as practical.

CAUTION: FCC/CSA regulations state that any unauthorized changes or modifications to this equipment may void the user's authority to operate it.

CAUTION: To prevent electric shock, match the wide blade of plug to the wide slot, and fully insert the plug.

IMPORTANT: One Federal Court has held that unauthorized recording of copyrighted TV programs is an infringement of U.S. copyright laws. Certain Canadian programs may also be copyrighted and any unauthorized recording in whole or in part may be in violation of these rights.

TO PREVENT DAMAGE WHICH MAY RESULT IN FIRE OR ELECTRIC SHOCK HAZARD, DO NOT EXPOSE THIS APPLIANCE TO RAIN OR MOISTURE.

The Socket-outlet should be installed near the apparatus and be easily accessible.

Read and follow these instructions when connecting and using your Public Information Display:



- Unplug the display if you are not going to use it for an extensive period of time.
- Unplug the display if you need to clean it with a slightly damp cloth. The screen may be wiped with a dry cloth when the power is off. However, never use alcohol, solvents or ammonia-based liquids.
- Consult a service technician if the display does not operate normally when you have followed the instructions in this manual.
- The casing cover should be opened only by qualified service personnel.
- Keep the display out of direct sunlight and away from stoves or any other heat sources.
- Remove any object that could fall into the vents or prevent proper cooling of the display's electronics.
- Do not block the ventilation holes on the cabinet.
- Keep the display dry. To avoid electric shock, do not expose it to rain or excessive moisture.
- If turning off the display by detaching the power cable, wait for 6 seconds before re-attaching the power cable for normal operation.
- To avoid the risk of shock or permanent damage to the set do not expose the display to rain or excessive moisture.
- When positioning the display, make sure the power plug and outlet are easily accessible.
- **IMPORTANT:** Always activate a screen saver program during your application. If a still image in high contrast remains on the screen for an extended period of time, it may leave an 'after-image' or 'ghost image' on the front of the screen. This is a well-known phenomenon that is caused by the shortcomings inherent in LCD technology. In most cases the afterimage will disappear gradually over a period of time after the power has been switched off. Be aware that the after-image symptom cannot be repaired and is not covered under warranty.

Regulatory Information

CE Declaration of Conformity

We declare under our responsibility that the product is in conformity with the following standards:

- EN60950-1:2006+A11:2009+A1:2010+A12:2011 (Safety requirement of Information Technology Equipment).
- EN55022:2010 (Radio Disturbance requirement of Information Technology Equipment).
- EN55024:2010 (Immunity requirement of Information Technology Equipment).
- EN61000-3-2:2006 +A1:2009+A2:2009 (Limits for Harmonic Current Emission).
- EN61000-3-3:2008 (Limitation of Voltage Fluctuation and Flicker) following provisions of directives applicable.
- 2006/95/EC (Low Voltage Directive).
- 2004/108/EC (EMC Directive).
- 2009/125/EC (ErP Directive, EC No. 1275/2008, 642/2009 Implementing Directive for Standby and Off mode power consumption).
- 93/68/EEC (Amendment of EMC and Low Voltage Directive) and is produced by a manufacturing organization on ISO9000 level.

Federal Communications Commission (FCC) Notice (U.S. Only)



This equipment has been tested and found to comply with the limits for a Class B digital device, pursuant to Part 15 of the FCC Rules. These limits are designed to provide reasonable protection against harmful interference when the equipment is operated in a commercial environment. This equipment generates, uses and can radiate radio frequency energy and, if not installed and used in accordance with the instructions manual, may cause harmful interference to radio communications. Operation of this equipment in a residential area is likely to cause harmful interference in which case the user will be required to correct the interference at his own expense.



Changes or modifications not expressly approved by the party responsible for compliance could void the user's authority to operate the equipment.

Use only an RF shielded cable that was supplied with the display when connecting this display to a computer device.

To prevent damage which may result in fire or shock hazard, do not expose this appliance to rain or excessive moisture.

THIS CLASS B DIGITAL APPARATUS MEETS ALL REQUIREMENTS OF THE CANADIAN INTERFERENCE- CAUSING EQUIPMENT REGULATIONS.



This device complies with Part 15 of the FCC Rules. Operation is subject to the following two conditions: (1) this device may not cause harmful interference, and (2) this device must accept any interference received, including interference that may cause undesired operation.

Polish Center for Testing and Certification Notice

The equipment should draw power from a socket with an attached protection circuit (a three-prong socket). All equipment that works together (computer, display, printer, and so on) should have the same power supply source.

The phasing conductor of the room's electrical installation should have a reserve short-circuit protection device in the form of a fuse with a nominal value no larger than 16 amperes (A).

To completely switch off the equipment, the power supply cable must be removed from the power supply socket, which should be located near the equipment and easily accessible.

A protection mark "B" confirms that the equipment is in compliance with the protection usage requirements of standards PN-93/T-42107 and PN-89/E-06251.

Wymagania Polskiego Centrum Badań i Certyfikacji

Urządzenie powinno być zasilane z gniazda z przyłączonym obwodem ochronnym (gniazdo z kolkiem). Współpracujące ze sobą urządzenia (komputer, monitor, drukarka) powinny być zasilane z tego samego źródła.

Instalacja elektryczna pomieszczenia powinna zawierać w przewodzie fazowym rezerwową ochronę przed zwarciami, w postaci bezpiecznika o wartości znamionowej nie większej niż 16A (amperów).

W celu całkowitego wyłączenia urządzenia z sieci zasilania, należy wyjąć wtyczkę kabla zasilającego z gniazdka, które powinno znajdować się w pobliżu urządzenia i być łatwo dostępne.

Znak bezpieczeństwa "B" potwierdza zgodność urządzenia z wymaganiami bezpieczeństwa użytkowania zawartymi w PN-93/T-42107 i PN-89/E-06251.

Pozostałe instrukcje bezpieczeństwa

- Nie należy używać wtyczek adapterowych lub usuwać kolka obwodu ochronnego z wtyczki. Jeżeli konieczne jest użycie przedłużacza to należy użyć przedłużacza 3-żyłowego z prawidłowo połączonym przewodem ochronnym.
- System komputerowy należy zabezpieczyć przed nagłymi, chwilowymi wzrostami lub spadkami napięcia, używając eliminatora przepięć, urządzenia dopasowującego lub bezzakłóceńowego źródła zasilania.
- Należy upewnić się, aby nie leżało na kablach systemu komputerowego, oraz aby kable nie były umieszczone w miejscu, gdzie można byłoby na nie nadeptywać lub potykać się o nie.
- Nie należy rozlewać napojów ani innych płynów na system komputerowy.
- Nie należy wpychać żadnych przedmiotów do otworów systemu komputerowego, gdyż może to spowodować pożar lub porażenie prądem, poprzez zwarcie elementów wewnętrznych.
- System komputerowy powinien znajdować się z dala od grzejników i źródeł ciepła. Ponadto, nie należy blokować otworów wentylacyjnych. Należy unikać kładzenia luźnych papierów pod komputer oraz umieszczania komputera w ciasnym miejscu bez możliwości cyrkulacji powietrza wokół niego.

Electric, Magnetic and Electromagnetic Fields ("EMF")

1. We manufacture and sell many products targeted at consumers, which, like any electronic apparatus, in general have the ability to emit and receive electromagnetic signals.
2. One of our leading Business Principles is to take all necessary health and safety measures for our products, to comply with all applicable legal requirements and to stay well within the EMF standards applicable at the time of producing the products.
3. We are committed to develop, produce and market products that cause no adverse health effects.
4. We confirm that if its products are handled properly for their intended use, they are safe to use according to scientific evidence available today.
5. We play an active role in the development of international EMF and safety standards, enabling us to anticipate further developments in standardization for early integration in its products.

Information for U.K. only

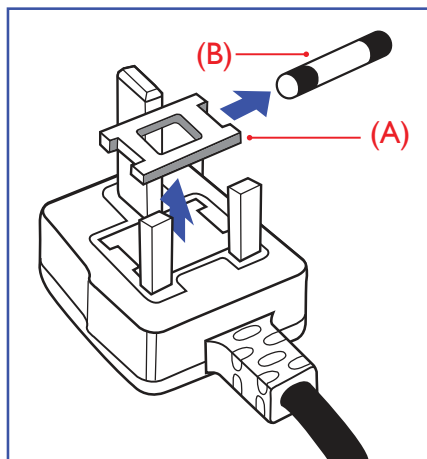

WARNING – THIS APPLIANCE MUST BE EARTHED.

Important:

This apparatus is supplied with an approved moulded 13A plug. To change a fuse in this type of plug proceed as follows:

1. Remove fuse cover and fuse.
2. Fit new fuse which should be a BS 1362 5A, A.S.T.A. or BSI approved type.
3. Refit the fuse cover.

If the fitted plug is not suitable for your socket outlets, it should be cut off and an appropriate 3-pin plug fitted in its place.

If the mains plug contains a fuse, this should have a value of 5A. If a plug without a fuse is used, the fuse at the distribution board should not be greater than 5A.

NOTE: The severed plug must be destroyed to avoid a possible shock hazard should it be inserted into a 13A socket elsewhere.

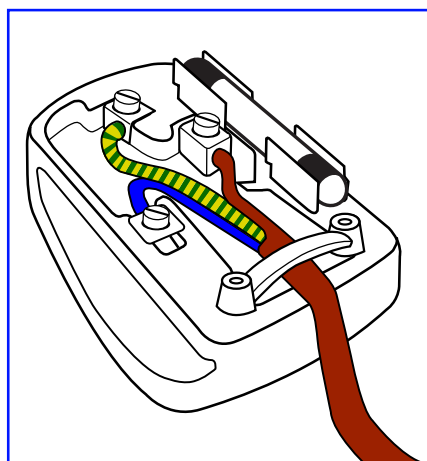

How to connect a plug

The wires in the mains lead are coloured in accordance with the following code:

BLUE – “NEUTRAL” (“N”)

BROWN – “LIVE” (“L”)

GREEN & YELLOW – “EARTH” (“E”)

1. The GREEN & YELLOW wire must be connected to the terminal in the plug which is marked with the letter “E” or by the Earth symbol or coloured GREEN or GREEN & YELLOW.
2. The BLUE wire must be connected to the terminal which is marked with the letter “N” or coloured BLACK.
3. The BROWN wire must be connected to the terminal which marked with the letter “L” or coloured RED.

Before replacing the plug cover, make certain that the cord grip is clamped over the sheath of the lead – not simply over the three wires.

China RoHS

中国电子信息产品污染控制标识要求 (中国RoHS法规标示要求) 产品中有毒有害物质或元素的名称及含量

部件名称	有毒有害物质或元素					
	铅 (Pb)	汞 (Hg)	镉 (Cd)	六价铬 (Cr 6+)	多溴联苯 (PBB)	多溴二苯醚 (PBDE)
外壳	○	○	○	○	○	○
液晶面板	×	×	○	○	○	○
电路板组件	×	○	○	○	○	○
附件 (遥控器, 电源线, 连接线)	×	○	○	○	○	○
遥控器电池	×	○	○	○	○	○

○: 表示该有毒有害物质在该部件所有均质材料中的含量均在 SJ/T11363-2006 标准规定的限量要求以下。

×: 表示该有毒有害物质至少在该部件的某一均质材料中的含量超出 SJ/T11363-2006 标准规定的限量要求。

**环保使用期限**

此标识指期限(十年)，电子信息产品中含有的有毒有害物质或元素在正常使用的条件下不会发生外泄或突变，电子信息产品用户使用该电子信息产品不会对环境造成严重污染或对其人身、财产造成严重损害的期限。

North Europe (Nordic Countries) Information

Placering/Ventilation

VARNING:

FÖRSÄKRA DIG OM ATT HUVUDBRYTARE OCH UTTAG ÄR LÄTÅTKOMLIGA, NÄR DU STÄLLER DIN UTRUSTNING PÅPLATS.

Placering/Ventilation

ADVARSEL:

SØRG VED PLACERINGEN FOR, AT NETLEDNINGENS STIK OG STIKKONTAKT ER NEMT TILGÆNDELIGE.

Paikka/Ilmankierto

VAROITUS:

SIJOITA LAITE SITEN, ETTÄ VERKKOJOHTO VOIDAAN TARVITTAESSA HELPOSTI IRROTTAA PISTORASIESTA.

Plassering/Ventilasjon

ADVARSEL:

NÅR DETTE UTSTYRET PLASSERES, MÅ DU PASSE PÅ AT KONTAKTENE FOR STØMTILFØRSEL ER LETTE Å NÅ.

End-of-Life Disposal

Your new Public Information Display contains materials that can be recycled and reused. Specialized companies can recycle your product to increase the amount of reusable materials and to minimize the amount to be disposed of.

Please find out about the local regulations on how to dispose of your old display from your local Philips dealer.

(For customers in Canada and U.S.A.)

This product may contain lead and/or mercury. Dispose of in accordance to local-state and federal regulations. For additional information on recycling contact www.eia.org (Consumer Education Initiative)

Waste Electrical and Electronic Equipment-WEEE

Attention users in European Union private households



This marking on the product or on its packaging illustrates that, under European Directive 2002/96/EG governing used electrical and electronic appliances, this product may not be disposed of with normal household waste. You are responsible for disposal of this equipment through a designated waste electrical and electronic equipment collection. To determine the locations for dropping off such waste electrical and electronic, contact your local government office, the waste disposal organization that serves your household or the store at which you purchased the product.

Attention users in United States:

Like all LCD products, this set contains a lamp with Mercury. Please dispose of according to all Local, State and Federal Laws. For the disposal or recycling information, contact: www.mygreenelectronics.com or www.eiae.org.

End of Life Directives-Recycling



Your new Public Information Display contains several materials that can be recycled for new users.

Like all LCD products, this set contains a lamp with Mercury. Please dispose of according to all Local, State, and Federal laws.

Table Of Contents

1. Unpacking and Installation.....	1		
1.1. Unpacking.....	1		
1.2. Package Contents.....	1		
1.3. Installation Notes.....	1		
1.4. Mounting on a Wall.....	2		
1.5. Mounting in Portrait Position.....	3		
1.5.1. How to use the logo guider for portrait position.....	3		
1.5.2. How to remove the logo.....	3		
2. Parts and Functions.....	4		
2.1. Control Panel.....	4		
2.2. Input/Output Terminals	5		
2.3. Remote Control.....	6		
2.3.1. General functions.....	6		
2.3.2. [FREEZE] operation.....	7		
2.3.3. Inserting the batteries in the remote control.....	7		
2.3.4. Handling the remote control.....	7		
2.3.5. Operating range of the remote control.....	7		
3. Connecting External Equipment	8		
3.1. Using the Switch Cover.....	8		
3.2. Connecting External Equipment (DVD/VCR/VCD)	9		
3.2.1. Using COMPONENT video input.....	9		
3.2.2. Using HDMI video input.....	9		
3.3. Connecting a PC.....	10		
3.3.1. Using VGA input.....	10		
3.3.2. Using DVI input	10		
3.3.3. Using HDMI input.....	10		
3.4. Connecting Audio Equipment.....	11		
3.4.1. Connecting external speakers.....	11		
3.4.2. Connecting an external audio device	11		
3.5. Connecting Multiple Displays in a Daisy-chain Configuration.....	12		
3.5.1. Control connection.....	12		
3.5.2. Video connection	12		
3.6. Fixing your external PC	13		
4. OSD Menu	14		
4.1. Navigating the OSD Menu.....	14		
4.1.1. Navigating the OSD menu using the remote control.....	14		
4.1.2. Navigating the OSD menu using the display's control buttons	14		
4.2. OSD Menu Overview.....	14		
4.2.1. Picture menu.....	14		
4.2.2. Screen menu	15		
4.2.3. Audio menu.....	16		
4.2.4. PIP menu	16		
4.2.5. Configuration1 menu.....	17		
4.2.6. Configuration2 menu.....	18		
4.2.7. Advanced option menu.....	18		
5. Input Mode.....	22		
6. Pixel Defect Policy.....	23		
6.1. Pixels and Sub-Pixels.....	23		
6.2. Types of Pixel Defects + Dot Definition.....	23		
6.3. Bright Dot Defects	23		
6.4. Dark Dot Defects	24		
6.5. Proximity of Pixel Defects.....	24		
6.6. Pixel Defect Tolerances	24		
6.7. MURA.....	24		
7. Cleaning and Troubleshooting.....	25		
7.1. Cleaning	25		
7.2. Troubleshooting.....	26		
8. Technical Specifications	27		

1. Unpacking and Installation

1.1. Unpacking

- This product is packed in a carton, together with the standard accessories.
- Any other optional accessories will be packed separately.
- Due to the size and weight of this display it is recommended for two people to move it.
- After opening the carton, ensure that the contents are complete and in good condition.

1.2. Package Contents

Please verify that you received the following items with your package content:

- LCD display
- CD ROM
- Remote control with AAA batteries
- Power cord (1.8 m)
- VGA cable (1.8 m)
- RS232 cable (3 m)
- Quick start guide
- Power switch cover
- Screw for power switch cover (M3x8)
- Logo guider

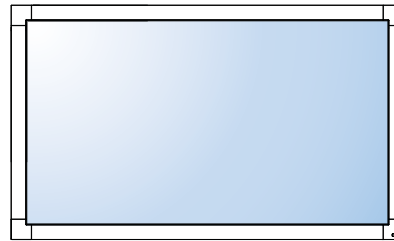

* The supplied power cord varies depending on destination.



For EU



For China



For North America



For UK



CD ROM



Quick Start Guide

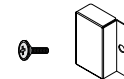

Power Switch Cover
and Screw (M3x8) x1

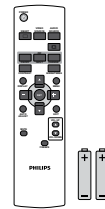

Remote Control
and AAA Batteries

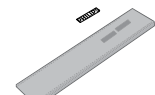

Logo Guider



RS232 Cable



VGA Cable

NOTES:

- For all other regions, apply a power cord that conforms to the AC voltage of the power socket and has been approved by and complies with the safety regulations of the particular country.
- You might like to save the package box and packing material for shipping the display.

1.3. Installation Notes

- Due to the high power consumption, always use the plug exclusively designed for this product. If an extended line is required, please consult your service agent.
- The product should be installed on a flat surface to avoid tipping. The distance between the back of the product and the wall should be maintained for proper ventilation. Avoid installing the product in the kitchen, bathroom or any other places with high humidity so as not to shorten the service life of the electronic components.
- The product can normally operate only under 5000 m in altitude. In installations at altitudes above 5000 m, some abnormalities may be experienced.

1.4. Mounting on a Wall

To mount this display to a wall, you will have to obtain a standard wall-mounting kit (commercially available). We recommend using a mounting interface that complies with UL1678 standard in North America.

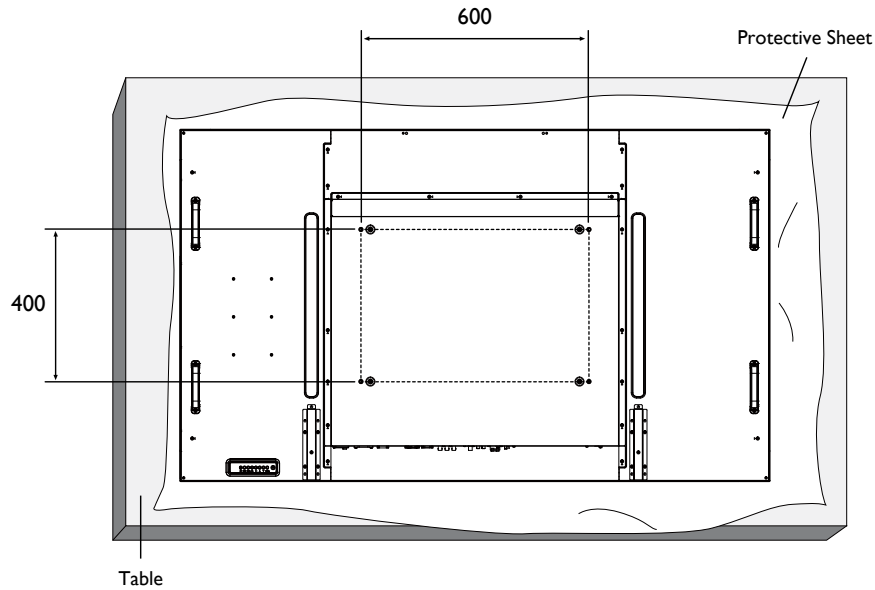

1. Lay a protective sheet on a table, which was wrapped around the display when it was packaged, beneath the screen surface so as not to scratch the screen face.
2. Ensure you have all accessories for mounting this display (wall mount, ceiling mount, table stand, etc).
3. Follow the instructions that come with the base mounting kit. Failure to follow correct mounting procedures could result in damage to the equipment or injury to the user or installer. Product warranty does not cover damage caused by improper installation.
4. For the wall-mounting kit, use M8 mounting screws (having a length 14 mm longer than the thickness of the mounting bracket) and tighten them securely.

Caution:

To prevent the display from falling:

- For wall or ceiling installation, we recommend installing the display with metal brackets which are commercially available. For detailed installation instructions, refer to the guide received with the respective bracket.
- To lessen the probability of injury and damage resulting from fall of the display in case of earthquake or other natural disaster, be sure to consult the bracket manufacturer for installation location.

Ventilation Requirements for enclosure locating

To allow heat to disperse, leave space between surrounding objects as shown in the diagram below.

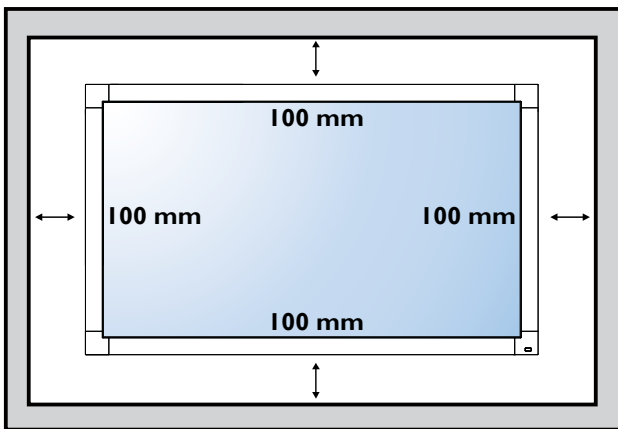

1.5. Mounting in Portrait Position

This display can be installed in portrait position.

1. Remove the table stand, if attached.
2. Rotate 90 degrees clockwise. The "PHILIPS" logo should be on the LEFT side when facing the display.

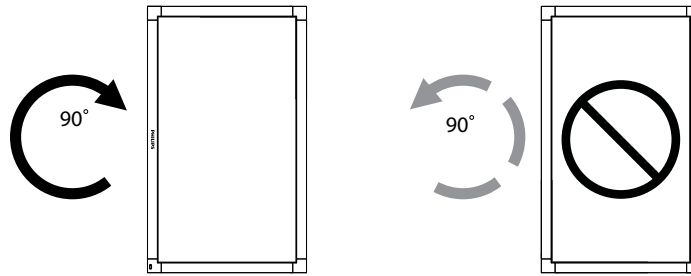

1.5.1. How to use the logo guider for portrait position

1. Put the guider on the lower-left corner of the front bezel of the display. Fold down both of its edges.
2. Peel off the protective film at the back of the "PHILIPS" logo sticker. Hold and press the guider with your left hand. Put the "PHILIPS" logo sticker with its adhesive side down into the logo hole with your right hand, and press to make it stick tightly onto the front bezel.
3. Remove the guider.

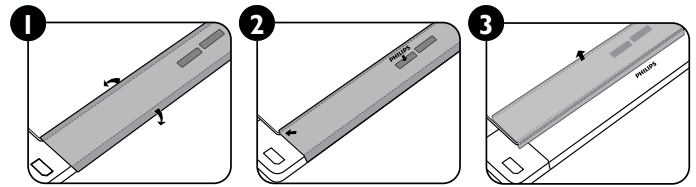

1.5.2. How to remove the logo

1. Prepare a piece of paper with a cutting area of logo as a protector to prevent the front bezel from scratching.
2. Using a knife, carefully remove the logo sticker with the paper placing beneath.
3. Tear off the logo sticker.

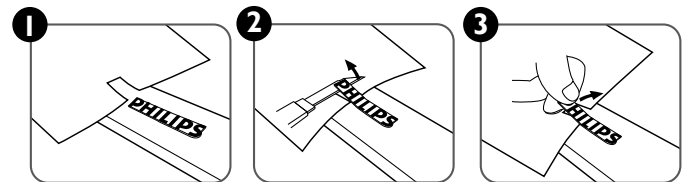

NOTE: When installing the display on a wall, please consult a professional technician for proper installation. We accept no liability for installations not performed by a professional technician.

2. Parts and Functions

2.1. Control Panel

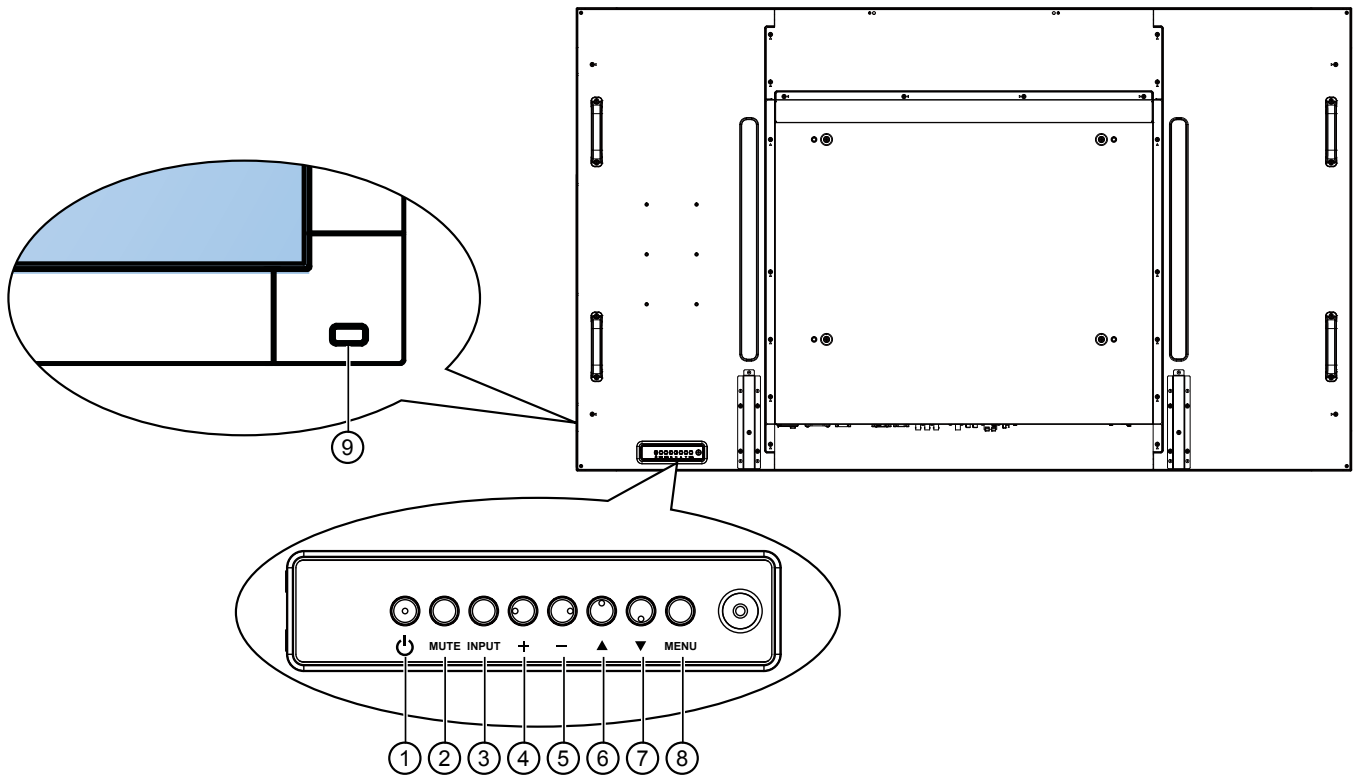

① [POWER] button

Press to turn the display on or put the display to standby.

② [MUTE] button

Press to switch the audio mute ON/OFF.

③ [INPUT] button

Press to select the input source.

④ [++] button

Press to increase the adjustment while OSD menu is on, or increase the audio output level while OSD menu is off.

- Used as [SET] button in the On-Screen-Display menu,

⑤ [--] button

Press to decrease the adjustment while OSD menu is on, or decrease the audio output level while OSD menu is off.

⑥ [▲] button

Press to move the highlight bar up to adjust the selected item while OSD menu is on.

⑦ [▼] button

Press to move the highlight bar down to adjust the selected item while OSD menu is on.

⑧ [MENU] button

Press to return to previous menu while OSD menu is on, or to activate the OSD menu when OSD menu is off.

NOTE: “Keyboard Control Lock Mode” This function completely disables the access to all Keyboard Control functions. To enable or disable the keyboard control lock, press both [++] and [--] buttons and hold down continuously for more than 3 (three) seconds.

⑨ Remote control sensor and power status indicator

- Receives command signals from the remote control.
- Indicates the operating status of the display without OPS:
 - Lights green when the display is turned on
 - Lights red when the display is in standby mode
 - Lights amber when the display enters APM mode
 - When {SCHEDULE} is enabled, the light blinks green and red
 - If the light blinks red, it indicates that a failure has been detected
 - Lights off when the main power of the display is turned off
- Indicates the operating status of the display with OPS:
 - Lights green when the display is on, but the OPS is off
 - Lights blue when the display and the OPS is on
 - Lights red when the display is in standby mode
 - Lights amber when the display enters APM mode
 - When {SCHEDULE} is enabled, the light blinks green and red
 - If the light blinks red, it indicates that a failure has been detected
 - Lights off when the main power of the display is turned off

2.2. Input/Output Terminals

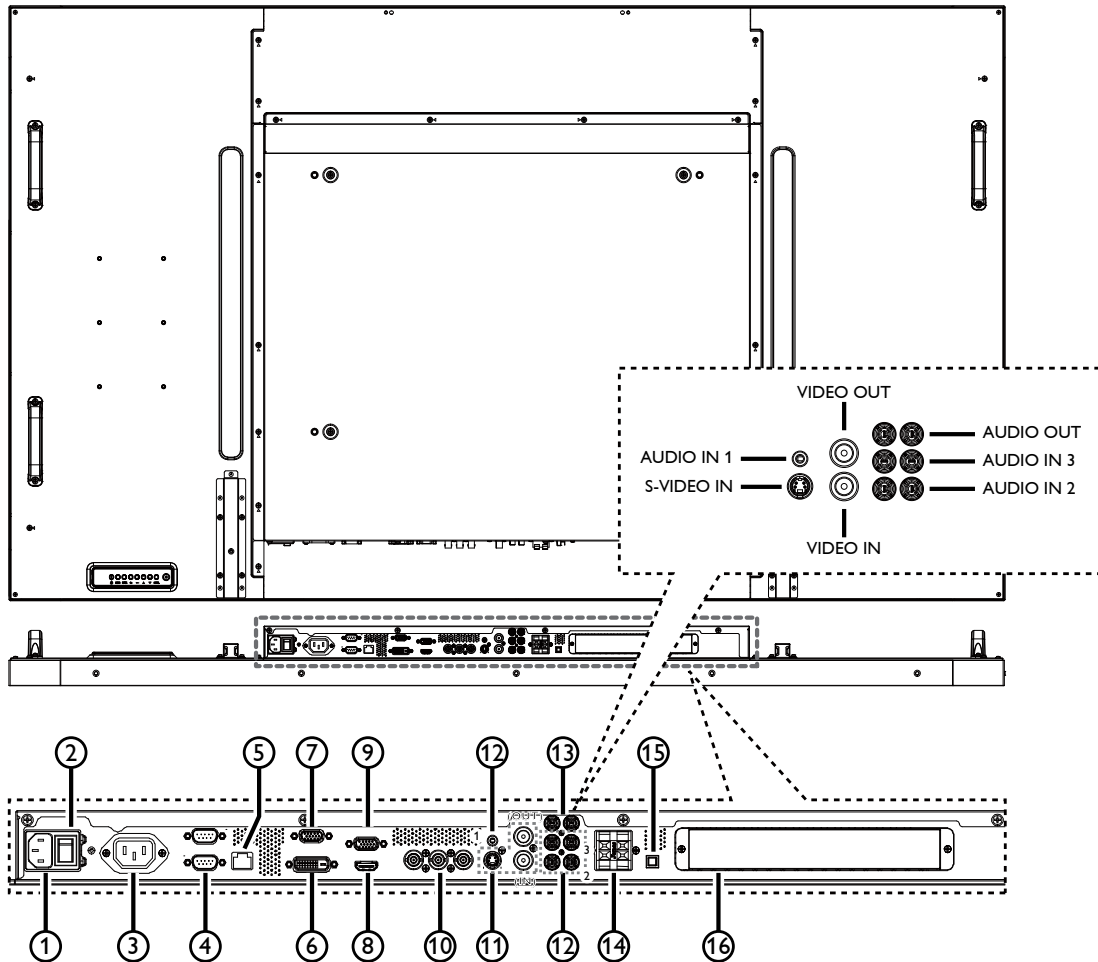

① **AC IN**

AC power input.

② **MAIN POWER SWITCH**

Main power on/off switch.

③ **AC OUT**

AC power output.

④ **RS232C IN / RS232C OUT**

RS232C network input/output for the loop-through function.

⑤ **RJ-45**

LAN port connection for your OPS device.

⑥ **DVI IN**

DVI-D video input.

⑦ **VGA OUT (D-Sub)**

VGA video output.

⑧ **HDMI IN**

HDMI video/audio input.

⑨ **VGA IN (D-Sub)**

VGA video input.

⑩ **COMPONENT IN (BNC)**

Component YPbPr video source input.

⑪ **VIDEO IN / VIDEO OUT**

- **S-VIDEO IN** (Mini DIN 4 pin): S-VIDEO (Y/C separate signal) input.
- **VIDEO IN** (BNC): Composite video signal input.
- **VIDEO OUT** (BNC): Composite video signal output from [VIDEO IN] jack.

⑫ **AUDIO IN 1 / AUDIO IN 2 / AUDIO IN 3**

Audio input from external AV device.

- **AUDIO IN 1**: 3.5 mm stereo phone jack
- **AUDIO IN 2, AUDIO IN 3**: RCA phone jack

⑬ **AUDIO OUT (RCA)**

Audio signal output from [AUDIO IN 1], [AUDIO IN 2], or [AUDIO IN 3] jack to connect your external AV device.

⑭ **SPEAKER OUT**

Audio output to external speakers.

⑮ **SPEAKER SWITCH**

Internal speaker on/off switch.

⑯ **OPS SLOT**

Connection slot for your OPS device.

2.3. Remote Control

2.3.1. General functions

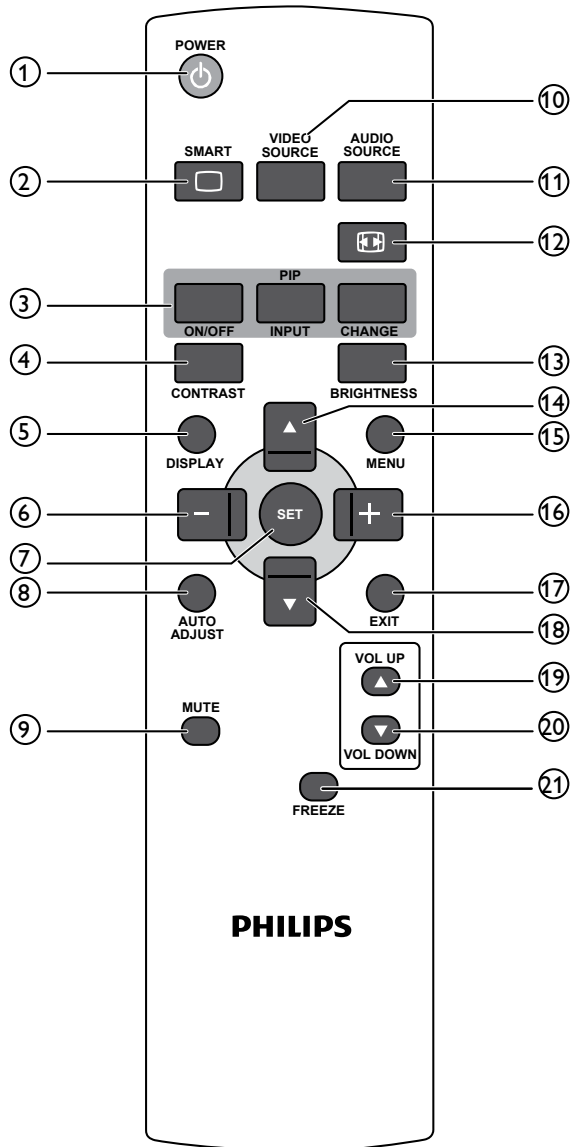

① [POWER] button

Press to switch on the display from standby mode. Press again to turn it off and back into standby mode.

② [SMART] button

Press to activate Smart Menu. Press [▲] or [▼] button to select menu options. Press [SET] button to confirm and exit the selection.

- **Standard:** Used for normal images (factory setting)
- **Highbright:** Used for moving image such as Video
- **sRGB:** Used for text based images

③ [PIP] (Picture In Picture) button

[ON/OFF]: Turn PIP mode on/off.

[INPUT]: Select the input signal for the sub-picture.

[CHANGE]: Toggle between the main picture and sub picture.

④ [CONTRAST] button

Press to activate Contrast Menu. Press [+] or [-] button to adjust the value. Press [MENU] button to confirm and exit.

⑤ [DISPLAY] button

Press to turn on/off the information OSD displayed on the upper right corner of the screen.

⑥ [-] button

- Press to move the selection left in OSD menu.
- Press to decrease the value in OSD menu.
- Press to move the sub-picture left in PIP mode.

⑦ [SET] button

Press to activate the setting inside the OSD menu.

⑧ [AUTO ADJUST] button

Press to run the Auto Adjust function.

NOTE: This button is functional for VGA input only.

⑨ [MUTE] button

Press to turn the mute function on/off.

⑩ [VIDEO SOURCE] button

Press to toggle Video Source Menu. Press [▲] or [▼] button to select one of the video sources among **HDMI, DVI-D, VGA, Component, S-Video, Video, or Card OPS**. Press [SET] button to confirm and exit.

⑪ [AUDIO SOURCE] button

Press to toggle Audio Source Menu. Press [▲] or [▼] button to select one of the audio sources among **HDMI, Audio1, Audio2, Audio3, or Card OPS**. Press [SET] button to confirm and exit.

⑫ Picture Format button

Press to switch screen aspect ratio.

- For PC signal: **FULL, NORMAL, CUSTOM, and REAL**.
- For Video signal: **FULL, NORMAL, DYNAMIC, CUSTOM, REAL, and 21:9**.

⑬ [BRIGHTNESS] button

Press to toggle Brightness Menu. Press [+] or [-] button to adjust the value. Press [MENU] button to confirm and exit.

⑭ [▲] button

- Press to move the selection up in OSD menu.
- Press to move the sub-picture up in PIP mode.

⑮ [MENU] button

Press to turn the OSD menu on/off.

⑯ [+] button

- Press to move the selection right in OSD menu.
- Press to increase the value in OSD menu.
- Press to move the sub-picture right in PIP mode.

⑰ [EXIT] button

Press to turn back to the previous OSD menu.

⑱ [▼] button

- Press to move the selection down in OSD menu.
- Press to move the sub-picture down in PIP mode.

⑲ [VOL UP] button

Press to increase the audio output level.

⑳ [VOL DOWN] button

Press to decrease the audio output level.

㉑ [FREEZE] button

Press to freeze screen image.

2.3.2. [FREEZE] operation

Press this button to freeze the screen image.

To freeze the screen image:

1. Press the [FREEZE] button on the remote control to activate the FREEZE function.
2. The screen plays the frozen image at the moment you activated this function, regardless of the source still being playing.
3. Press the [FREEZE] button again to deactivate the FREEZE function. The screen plays back the live video source.

NOTES:

- To activate the FREEZE function, you will have to set the OSD option {Configuration1} → {Panel saving} → {Pixel shift} setting to {Off}.
- While activated the FREEZE operation, the other actions, like turning on/off the power, switching sources, or selecting image timing, will force releasing the FREEZE function and restore playing the live video source.
- If the video source of the frozen image is disconnected, the display will blackout, and a "No Signal" message will appear on the screen. The screen will restore playing the live video source if the video source of the frozen image is connected back.

2.3.3. Inserting the batteries in the remote control

The remote control is powered by two 1.5V AAA batteries.

To install or replace batteries:

1. Press and then slide the cover to open it.
2. Align the batteries according to the (+) and (-) indications inside the battery compartment.
3. Replace the cover.

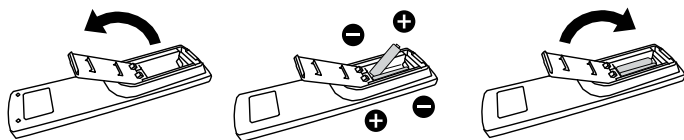

Caution:

The incorrect use of batteries can result in leaks or bursting. Be sure to follow these instructions:

- Place "AAA" batteries matching the (+) and (-) signs on each battery to the (+) and (-) signs of the battery compartment.
- Do not mix battery types.
- Do not combine new batteries with used ones. It causes shorter life or leakage of batteries.
- Remove the dead batteries immediately to prevent them from liquid leaking in the battery compartment. Don't touch exposed battery acid, as it can damage your skin.

NOTE: If you do not intend to use the remote control for a long period, remove the batteries.

2.3.4. Handling the remote control

- Do not subject to strong shock.
- Do not allow water or other liquid to splash the remote control. If the remote control gets wet, wipe it dry immediately.
- Avoid exposure to heat and steam.
- Other than to install the batteries, do not open the remote control.

2.3.5. Operating range of the remote control

Point the top of the remote control toward the display's remote control sensor when pressing a button.

Use the remote control within a distance of less than 10m/33ft from the display's sensor; and a horizontal and vertical angle of less than 30 degrees.

NOTE: The remote control may not function properly when the remote control sensor on the display is under direct sunlight or strong illumination, or when there is an obstacle in the path of signal transmission.

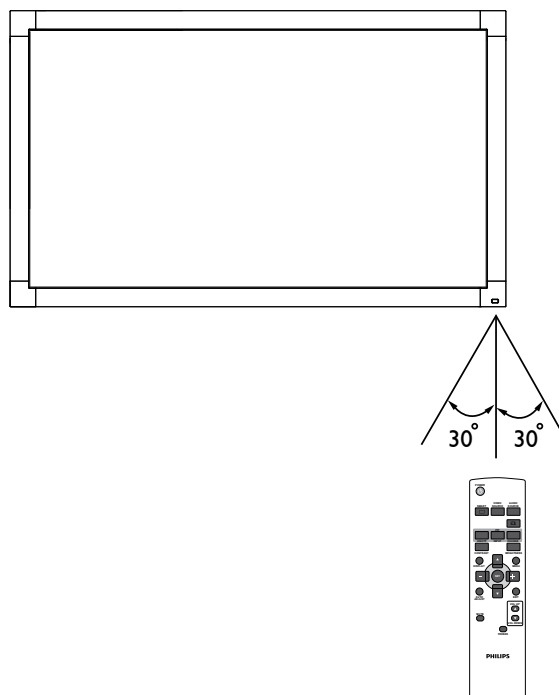

3. Connecting External Equipment

3.1. Using the Switch Cover

A cover for the power switch is provided to prevent the display from being turned on or off accidentally.

To lock the cover into position:

1. Align and insert the cover to the indentation located beside the power switch.
2. Use the screw to lock the cover.

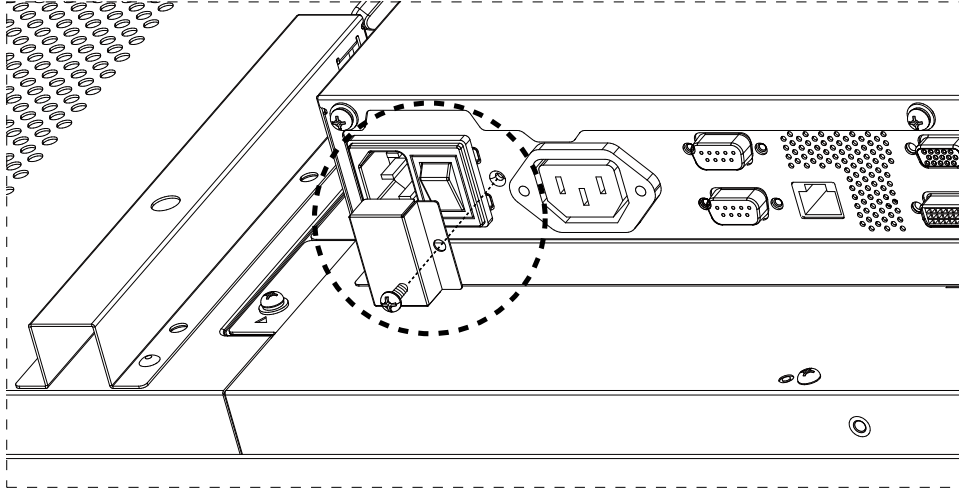

3.2. Connecting External Equipment (DVD/VCR/VCD)

3.2.1. Using COMPONENT video input

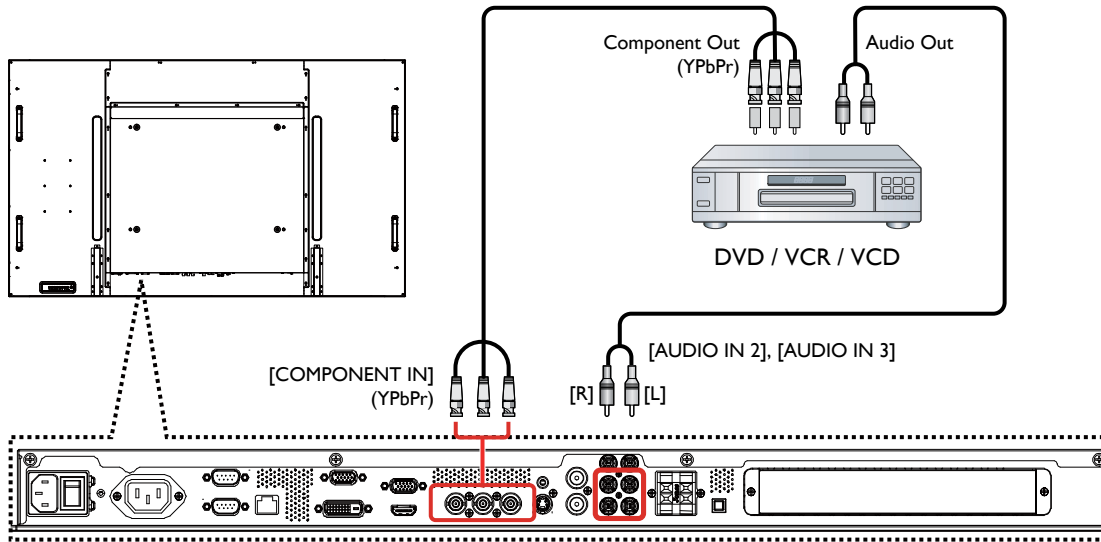

3.2.2. Using HDMI video input

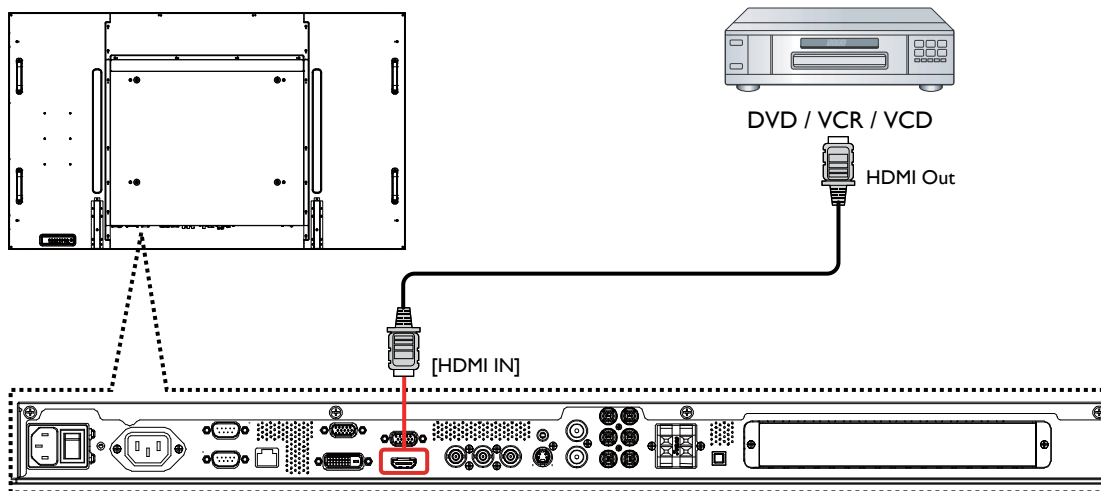

3.3. Connecting a PC

3.3.1. Using VGA input

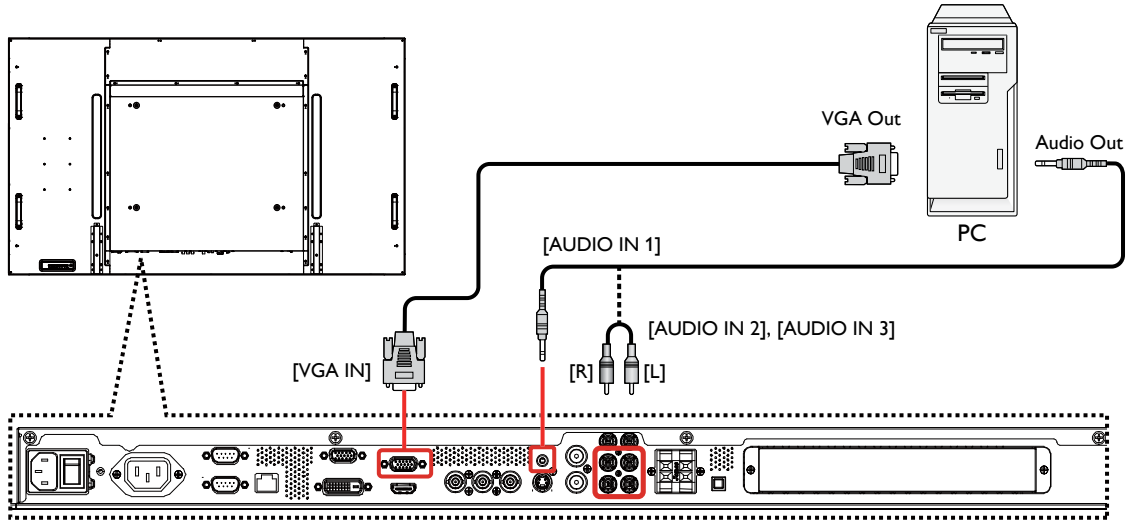

3.3.2. Using DVI input

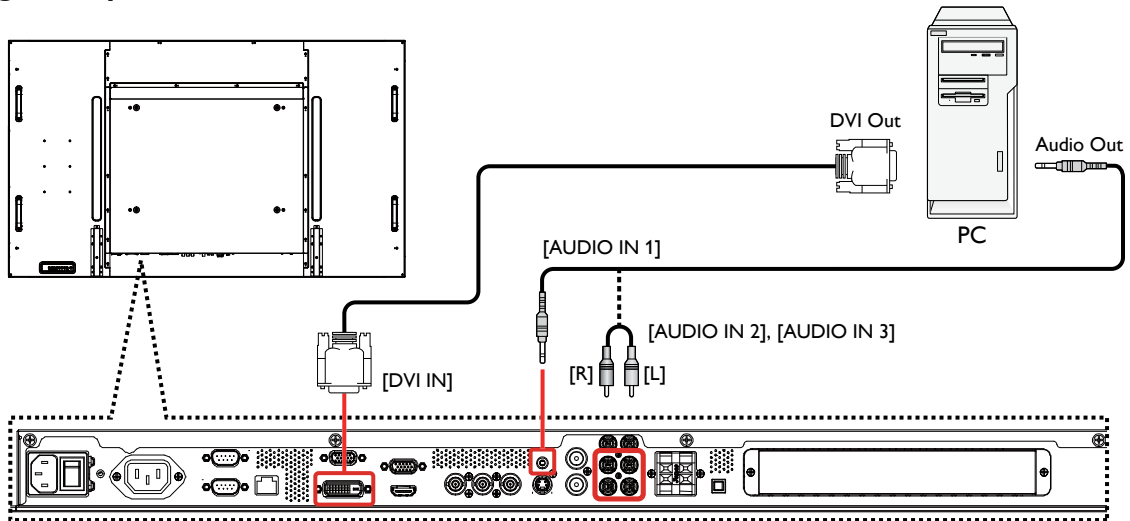

3.3.3. Using HDMI input

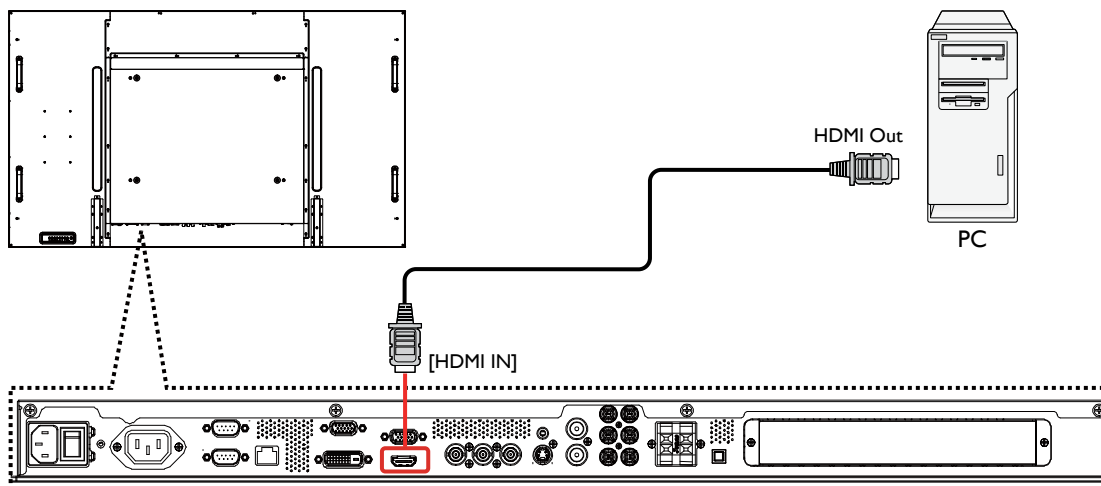

3.4. Connecting Audio Equipment

3.4.1. Connecting external speakers

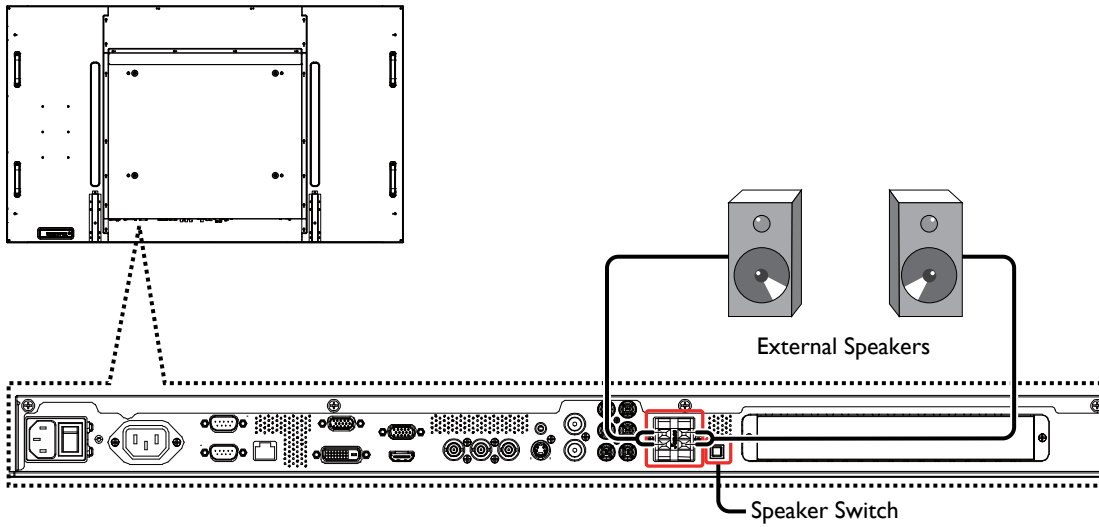

NOTE: Press the [Speaker Switch] to select either the internal or external speakers according to your connection.

3.4.2. Connecting an external audio device

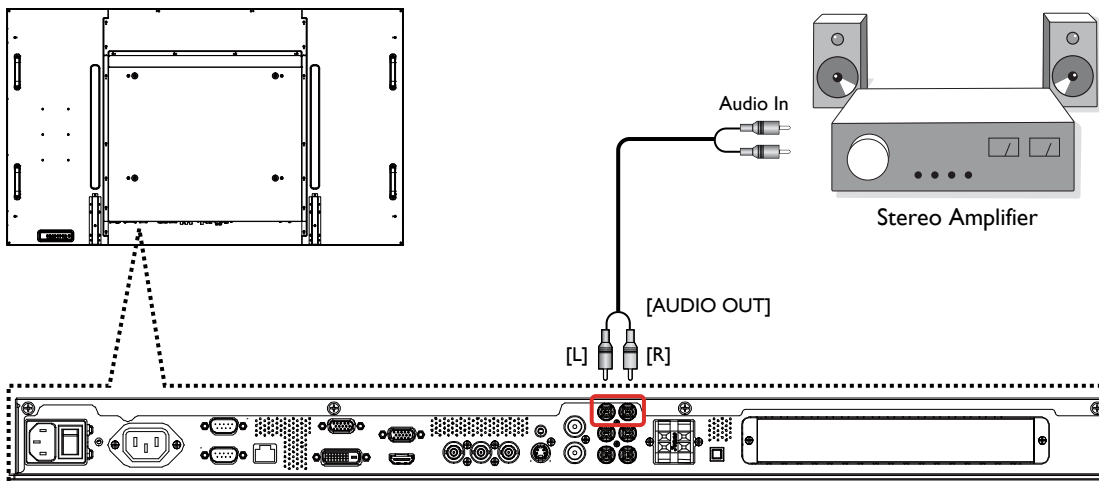

3.5. Connecting Multiple Displays in a Daisy-chain Configuration

You can interconnect multiple displays to create a daisy-chain configuration for applications such as a video wall.

NOTE: Up to maximum 25 displays (5x5) can be used in a daisy-chain configuration.

3.5.1. Control connection

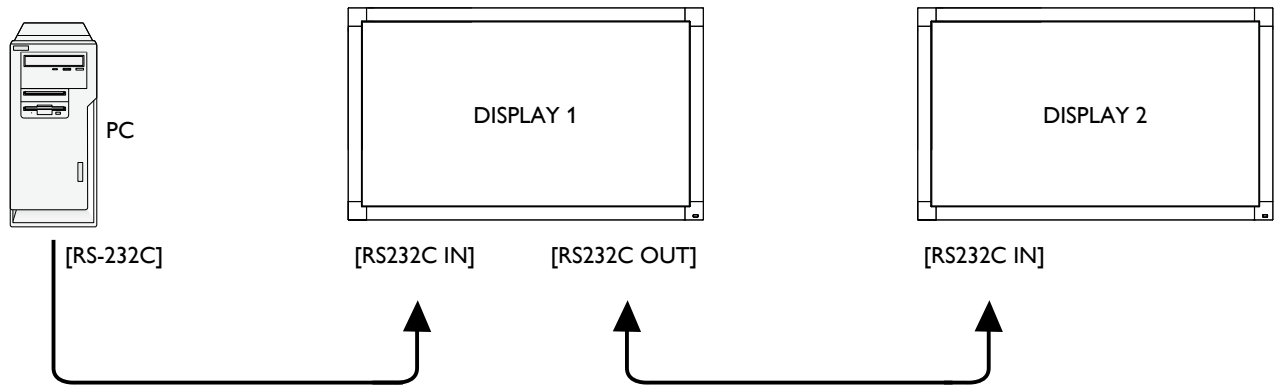

3.5.2. Video connection

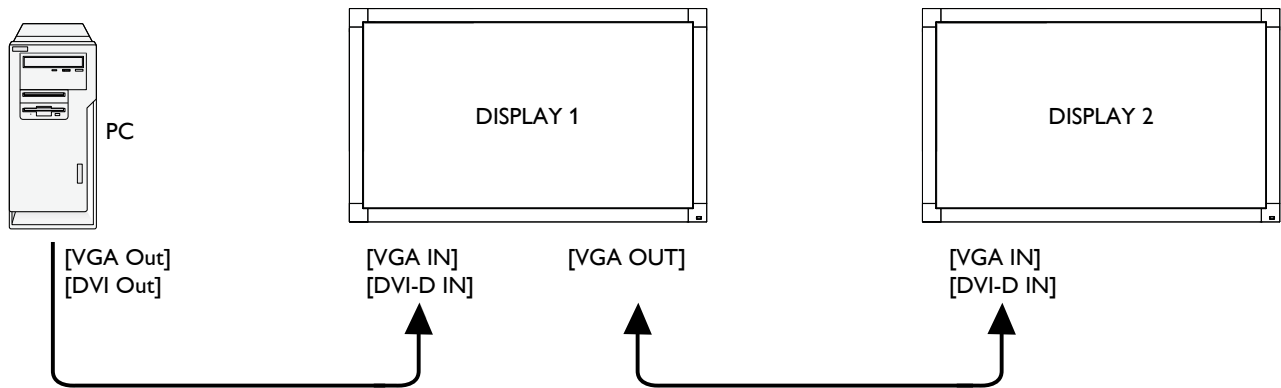

3.6. Fixing your external PC

This side panel reserved 6 pcs of M4 screw holes with 100 mm pitch for mounting your Smart Insert Module. (by using M4x10 screw)

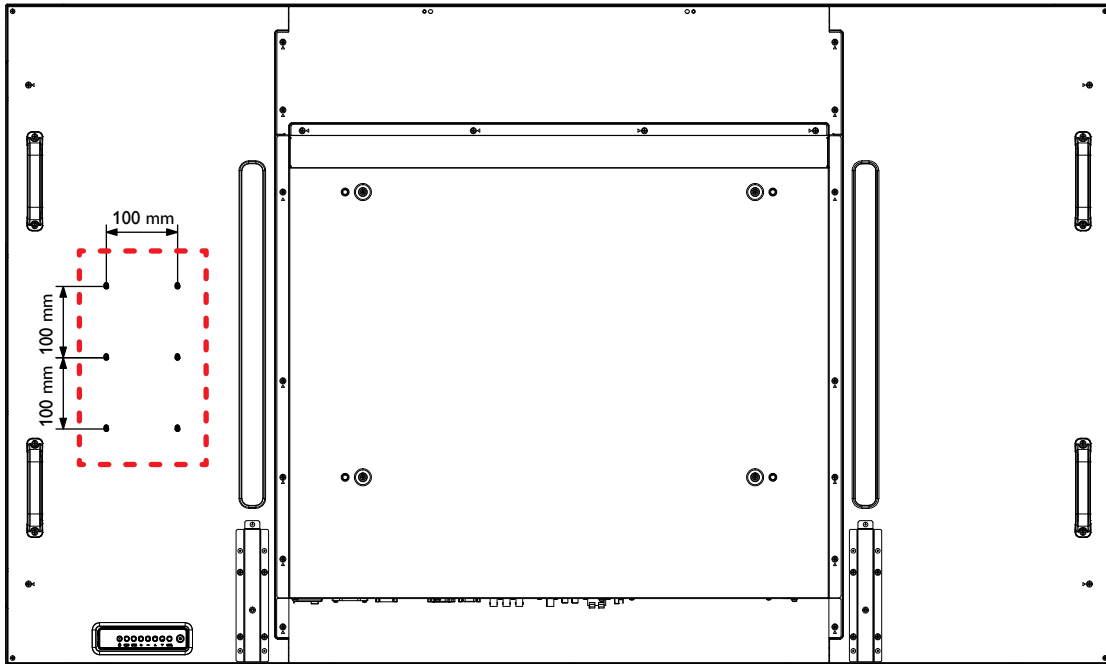

4. OSD Menu

An overall view of the On-Screen Display (OSD) structure is shown below. You can use it as a reference for further adjusting your display.

4.1. Navigating the OSD Menu

4.1.1. Navigating the OSD menu using the remote control

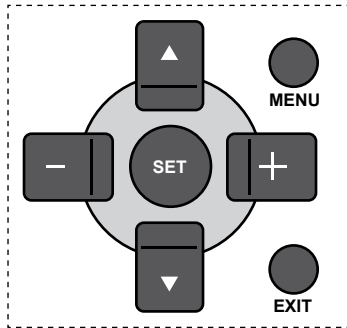

1. Press [**MENU**] button on the remote control to display the OSD menu.
2. Press [**▲**] or [**▼**] button to choose the item you want to adjust.
3. Press [**SET**] or [**+**] button to enter the submenu.
4. In the submenu, press [**▲**] or [**▼**] button to toggle among items, press [**+**] or [**-**] button to adjust settings. If there is a submenu, press [**SET**] or [**+**] button to enter the submenu.
5. Press [**EXIT**] button to return to the previous menu, or press [**MENU**] button to exit the OSD menu.

4.1.2. Navigating the OSD menu using the display's control buttons

1. Press [**MENU**] button to display the OSD menu.
2. Press [**▲**] or [**▼**] button to choose the item you want to adjust.
3. Press [**+**] button to enter the submenu.
4. In the submenu, press [**▲**] or [**▼**] button to toggle among items, press [**+**] or [**-**] button to adjust settings. If there is a submenu, press [**+**] button to enter the submenu.
5. Press [**MENU**] button to return to the previous menu, or press [**MENU**] button several times to exit the OSD menu.

4.2. OSD Menu Overview

4.2.1. Picture menu

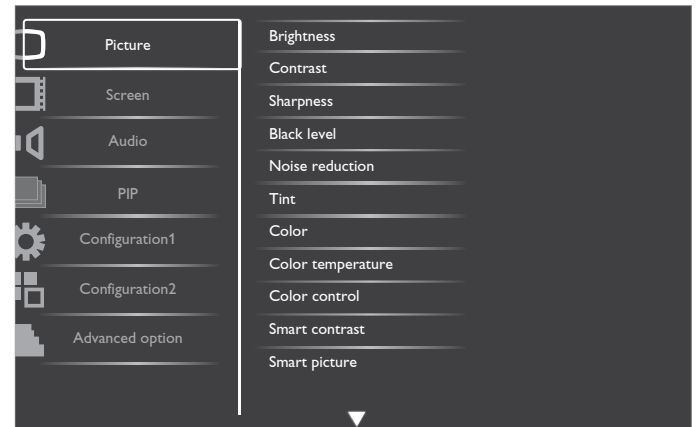

Brightness

Adjust the overall image brightness by changing the intensity of the LCD panel's backlight.

Contrast

Adjust to sharpen the picture quality. The black portions of the picture become richer in darkness and the white become brighter.

Sharpness

Adjust to improve the image detail.

Black level

Video black level is defined as the level of brightness at the darkest (black) part of a visual image. Adjust to change the image brightness.

Noise reduction

Adjust to remove the noise in the image. You can select a suitable noise reduction level.

Choose from: {Off} / {Low} / {Medium} / {High}.

NOTE: This item is functional for **HDMI**(Video mode), **Video**, and **YPbPr** inputs only.

Tint

Adjust to change the color tint of the image.

Use the [**+**] or [**-**] button to adjust. Press the [**+**] button and the flesh tone color turns slightly green. Press the [**-**] button and the flesh tone color turns slightly purple.

NOTE: This item is functional for **HDMI**(Video mode), **Video**, and **YPbPr** inputs only.

Color

Adjust to increase or decrease the intensity of colors in the image.

NOTE: This item is functional for **HDMI**(Video mode), **Video** and **YPbPr** inputs only.

Color temperature

Select a color temperature for the image. A lower color temperature will have a reddish tint, whilst a higher color temperature gives off a more bluish tint.

Choose from: {3000K} / {4000K} / {5000K} / {6500K} / {7500K} / {9300K} / {10000K} / {Native} / {User}.

Color control

With this function you can adjust the color tones of the image precisely by changing the R (Red), G (Green) and B (Blue) settings independently.

NOTE: This item is functional only when {Color temperature} is set to {User}.

Smart contrast

When turned on, this function helps enhance image contrast when displaying dark scenes.

Smart picture

The following smart picture modes are available for:

- PC mode: {Standard} / {Highbright} / {sRGB}.
- Video mode: {Standard} / {Highbright} / {Cinema}.

Video source

Select the video input source according to the video signal source connected to the video input on the display.

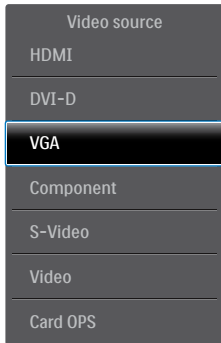

Picture reset

Reset all settings in the **Picture** menu.

4.2.2. Screen menu

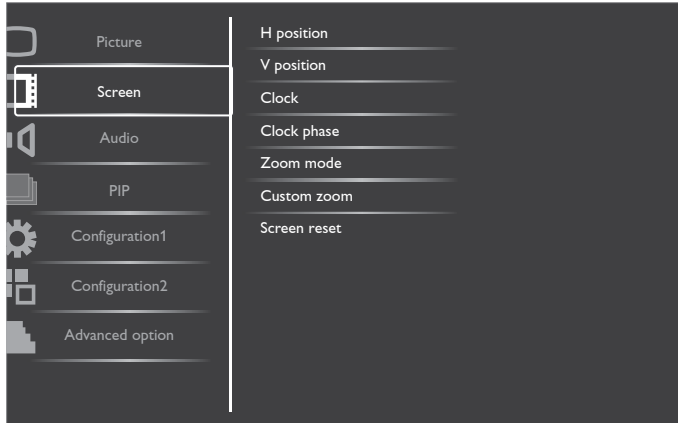

H position

Press the [+] button to move the image to the right, or [-] to move the image to the left.

NOTE: This item is functional for all inputs except **HDMI** and **Card OPS** in video mode.

V position

Press the [+] button to move the image up, or [-] to move the image down.

NOTE: This item is functional for all inputs except **HDMI** and **Card OPS** in video mode.

Clock

Adjust the width of the image.

NOTE: This item is functional for **VGA** input only.

Clock phase

Adjust to improve the focus, clarity and stability of the image.

NOTE: This item is functional for **VGA** input only.

Zoom mode

The pictures you receive may be transmitted in 16:9 format (wide screen) or 4:3 format (conventional screen). The 16:9 pictures sometimes have a black band at the top and bottom of the screen (letterbox format).

This function allows you to optimize the picture display on screen. The following zoom modes are available for:

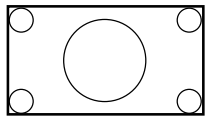
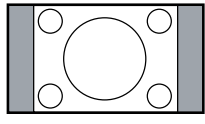
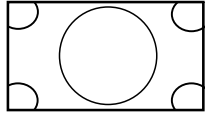
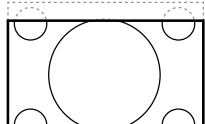

- PC mode: {Full} / {Normal} / {Custom} / {Real}.
- Video mode: {Full} / {Normal} / {Dynamic} / {Custom} / {Real} / {21:9}.

	Full This mode restores the correct proportions of pictures transmitted in 16:9 using the full screen display.
	Normal The picture is reproduced in 4:3 format and a black band is displayed on either side of the picture.
	Dynamic Fill the entire screen by stretching 4:3 pictures non-proportionally.
	Custom Choose to apply the custom zoom settings in the Custom Zoom submenu.
	Real This mode displays the image pixel-by-pixel on screen without scaling the original image size.
	21:9 The picture is enlarged to 16:9 format. This mode is recommended when displaying pictures that have black bands at the top and bottom (letterbox format).

Custom zoom

You can use this function to further customize the zoom settings to suit the image you want to display.

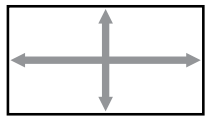
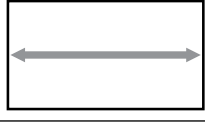
NOTE: This item is functional only when the **Zoom mode** setting is set to **Custom**.

	Zoom Expands the horizontal and vertical sizes of the image simultaneously.
	H zoom Expands the horizontal size of the image only.
	V zoom Expands the vertical size of the image only.

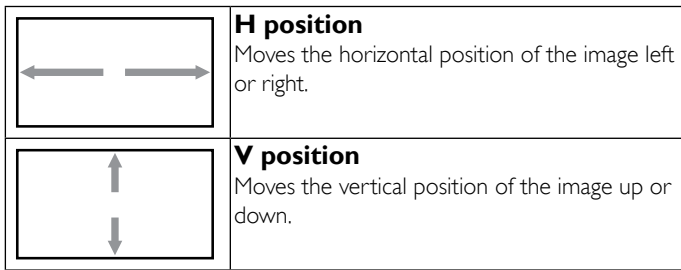
**Screen reset**

Reset all settings in the **Screen** menu to factory preset values.

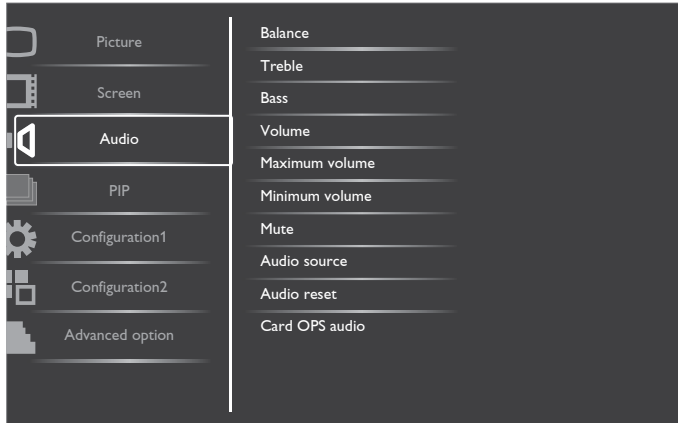
4.2.3. Audio menu**Balance**

Adjust to emphasize left or right audio output balance.

Treble

Adjust to increase or decrease higher-pitched sounds.

Bass

Adjust to increase or decrease lower-pitched sounds.

Volume

Adjust to increase or decrease the audio output level.

Maximum volume

Adjust your own limitation for the maximum volume setting. This stops the volume from being playing at too loud a level.

Minimum volume

Adjust your own limitation for the minimum volume setting.

Mute

Turn the mute function on/off.

Audio source

Select the audio input source according to the audio signal source connected to the audio input and HDMI sockets on the display.

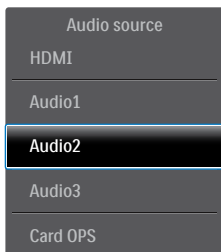
**Audio reset**

Reset all settings in the **Audio** menu to factory preset values.

Card OPS audio

Select the analog or digital audio mode for card OPS.

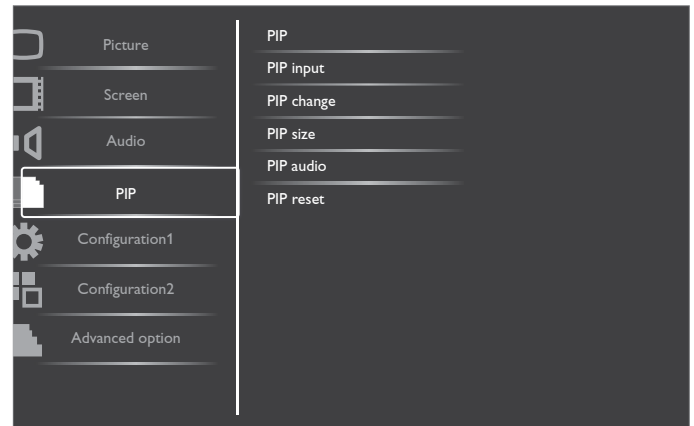
4.2.4. PIP menu**PIP**

Select the PIP (Picture-in-Picture) mode.

Choose from: {Off} / {PIP} / {POP} / {PBP aspect} / {PBP full}.

PIP input

Select the input signal for the sub-picture.

PIP change

Enlarges the smaller picture to become the main picture, and vice versa.

PIP size

Select the size of the sub picture in the PIP (Picture-in-Picture) mode.

Choose from: {Small} / {Medium} / {Large}.

PIP audio

Select the audio source in the PIP (Picture-in-Picture) mode.

- {Main} – Select audio from the main picture
- {Sub} – Select audio from the sub picture.

PIP reset

Reset all settings in the **PIP** menu to factory preset values.

NOTES:

- The PIP function is available only under the following condition:
Set OSD option {Configuration1} → {Panel saving} → {Pixel shift} setting to {Off}, and set OSD option {Advanced option} → {Tiling} → {Enable} setting to {No}.
- The PIP function is available only for certain signal source combinations as shown in the table below.
- The availability of the PIP function will also depend on the resolution of the input signal being used.

Main Picture Sub Picture	HDMI	DVI-D	VGA	YPbPr	S-Video	Video	Card OPS
HDMI	X	X	X	X	O	O	X
DVI-D	X	X	X	X	O	O	X
VGA	X	X	X	X	O	O	X
YPbPr	X	X	X	X	O	O	X
Video	O	O	O	O	X	X	O
Video	O	O	O	O	X	X	O
Card OPS	X	X	X	X	O	O	X

(O: PIP function available, X: PIP function unavailable)

By pressing the [PIP ON/OFF] button on the remote control, you can change the mode in the order shown below:

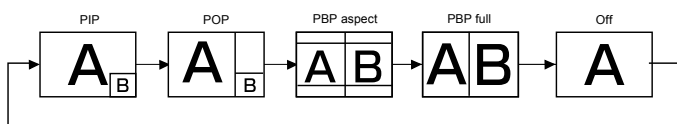

The resolutions in the PIP and POP modes are configured as follows:

PIP SIZE {Small} : 320 × 240 pixels
 {Medium} : 480 × 320 pixels
 {Large} : 640 × 480 pixels

POP SIZE: 474 × 355 pixels

NOTE: The images displayed in the sub picture always fit the PIP sizes shown above irrespective of the aspect ratio of the input image.

4.2.5. Configuration1 menu

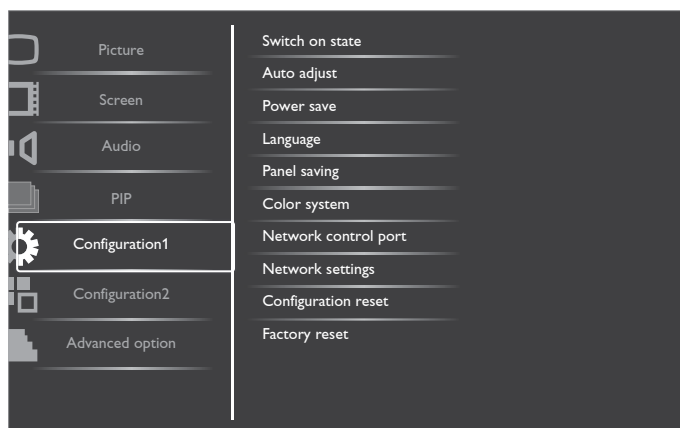

Switch on state

Select the display status used for the next time you connect the power cord.

- {Power off} – The display will remain off when the power cord is connected to a wall outlet.
- {Forced on} – The display will turn on when the power cord is connected to a wall outlet.
- {Last status} – The display will return to the previous power status (on/off/standby) when removing and replacing the power cord.

Auto adjust

Use this function to automatically optimize the display of VGA input image.

NOTE: This item is functional for VGA input only.

Power save

Use this setting to reduce the power automatically.

- {RGB} – Select {On} to let the display enter APM mode when no signal is detected from the HDMI Graphic mode, HDMI, DVI-D, or VGA inputs after 30 seconds.
- {VIDEO} – Select {On} to enter power saving mode when no signal is detected from the HDMI Video mode or YPbPr inputs after 30 minutes.

Language

Select the language used in the OSD menu.

The options are: {English} / {Deutsch} / {简体中文} / {Français} / {Italiano} / {Español} / {Русский} / {Polski} / {Türkçe} / {繁體中文}.

Panel saving

Choose to enable the panel saving functions and thus reduce the risk of “image persistence” or “ghost-imaging”.

- {Cooling Fan} – Select {On} to turn on the cooling fan all the time. Select {Auto} to turn on/off the cooling fan according to the display’s temperature.

NOTES:

- The default {Auto} option will start running the cooling fan if the temperature of 60°C (140°F) is reached, and will keep running for 30 minutes after cooling down to the temperature of 58°C (136°F).
- A temperature-warning message will be shown on the screen if the temperature reaches 79°C (174°F). All key functions except [Power] key will then be disabled.
- Once the temperature reaches 80°C (176°F), the display power will be shut down automatically.
- {Brightness} – Select {On} and the image brightness will be reduced to an appropriate level. The Brightness setting in the Picture menu will be unavailable when selected.
- {Pixel shift} – Select the time interval ({Auto} / {10 ~ 900} Seconds / {Off}) for the display to slightly expand the image size and shift the position of pixels in four directions (up, down, left, or right).

Color system

Selects the Color System depending on your input video format.

The options are: {Auto} / {NTSC} / {PAL} / {SECAM} / {4.43NTSC} / {PAL-60}.

NOTE: This item is functional for VIDEO input only.

Network control port

Select the network control port.

Choose from: {RS232} / {LAN(RJ45)} / {Card OPS RS232}.

NOTES:

- If {LAN(RJ45)} is selected, then {RS232} will not be activated, even if a cable is attached, and vice versa.
- The option {Card OPS RS232} is functional after connected with your OPS device.

Network settings

Assign {IP address}, {Subnet Mask}, and {Default gateway} for the display.

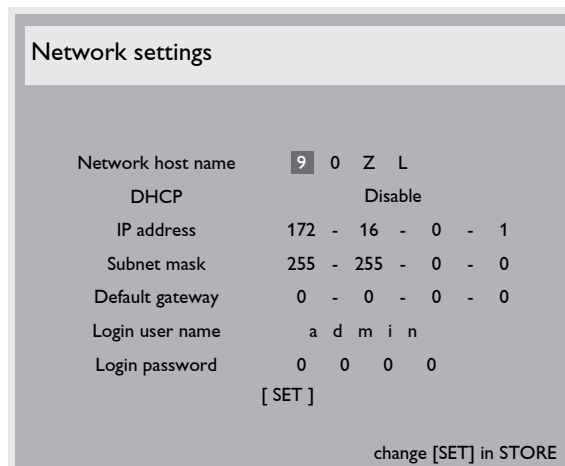

- DHCP – Choose to enable or disable the DHCP function. If enabled, the display will be assigned IP address, Subnet mask and Default gateway automatically. If disabled, you will be prompted

to enter the following values manually. When finished, press [SET] button to store and save the chosen values.

- IP address
- Subnet mask
- Default gateway
- Login user name (The default user name is {admin})
- Login password (The default password is {0000})

Configuration reset

Reset all settings in **Configuration1** menu to the factory preset values.

Factory reset

Reset all settings in the OSD menus of {Picture}, {Screen}, {Audio}, {PIP}, {Configuration1}, {Configuration2}, and {Advanced option} to the factory preset values.

Press [+] or [-] button to select [Reset], and then press [SET] button to do the reset.

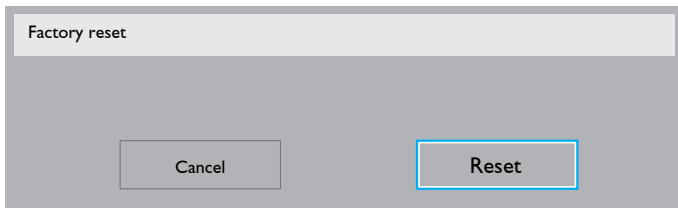

4.2.6. Configuration2 menu

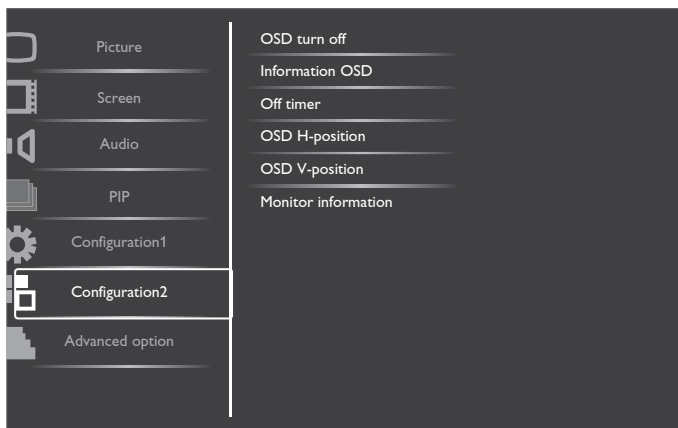

OSD turn off

Set the period of time the OSD (on-screen display) menu stays on the screen.

The options are: {5 ~ 120} seconds.

Information OSD

Set the period of time the information OSD is displayed on the upper right corner of the screen. The information OSD will display when input signal is changed.

The information OSD will remain on the screen with {Off} selection.

The options are: {1 ~ 60} seconds.

Off Timer

Set the display to turn itself off to standby mode within an amount of time specified.

The options are: {Off, 1 ~ 24} hours from current time.

NOTE: When the "Off timer" is activated, the "Schedule" settings will be disabled.

OSD H-position

Adjust the horizontal position of the OSD menu.

OSD V-position

Adjust the vertical position of the OSD menu.

Monitor information

Shows information about your display, including model number, serial number, operating hours and software version.



4.2.7. Advanced option menu

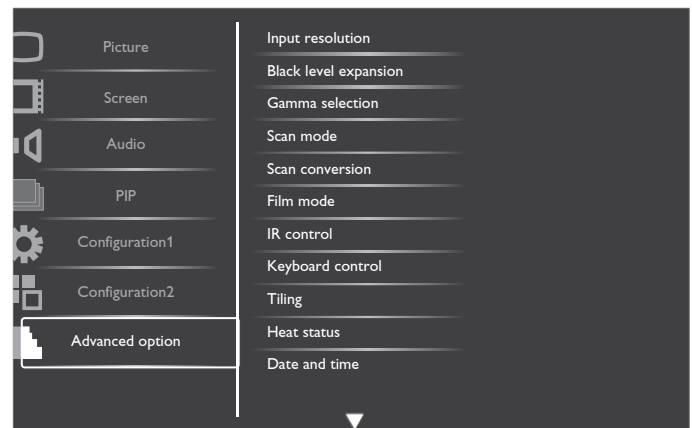

Input resolution

Set the resolution of the VGA input. This is only required when the display is unable to detect the VGA input resolution correctly.

NOTE: This item is functional for **VGA** input only.

The options are:

- {1024x768 / 1280x768 / 1360x768 / 1366x768}
- {1400x1050 / 1680x1050}
- {1600x1200 / 1920x1200}
- {Auto}: Determines the resolution automatically.

The selected settings will become effective after turning off the power and turning it on again.

Black level expansion

This feature offers deeper blacks for an even better image quality.

The options are: {Off} / {Low} / {Medium} / {High}.

NOTE: This item is functional for **Video** mode input only.

Gamma selection

Gamma is what controls the overall brightness of an image. Images which are not corrected properly can appear too white or too dark, so controlling the gamma properly can have a huge influence on the overall picture quality of your display.

The options are: {Native} / {2.2} / {2.4} / {S gamma}.

Scan mode

Change the display area of the image.

- **{Overscan}** – Display about 95% of the original size of the image. The rest of the areas surrounding the image will be cut off.
- **{Underscan}** – Display the image in its original size.

NOTE: This item is functional for **Video** mode input only.

Scan conversion

Choose to enable or disable the IP (Interlace to Progressive) conversion function.

- **{Progressive}** – Enable the IP conversion function (recommended). Once enabled, the interlace input signal will be converted to progressive format for better display quality.
- **{Interlace}** – Disable the IP function. This mode is suitable for displaying motion pictures, but it increases the chance of image retention.

Film mode

Choose to turn on or off the film mode frame conversion function.

- **{Auto}** – Enable the film mode frame conversion function for movies and motion pictures. The display converts a 24 frames-per-second (24 fps) input signal format to DVD video signal format. Once this function is enabled, it is recommended that you set the **{Scan conversion}** function to **{Progressive}**.
- **{Off}** – Disable the film mode frame conversion function. This mode is suitable for TV broadcasting and VCR signals.

IR control

Select the operation mode of the remote control when multiple displays are connected via an RS232C connection.

- **{Normal}** – All displays can be operated normally by the remote control unit.
- **{Primary}** – Designate this display as the primary display for remote control operation. Only this display can be operated by the remote control.
- **{Secondary}** – Designate this display as the secondary display. This display can not be operated by the remote control, and will only receive the control signal from the primary display via the RS232C connection.
- **{Lock All}** / **{Lock all but Volume}** / **{Lock all but Power}** – Lock the remote control function of this display. To unlock, press and hold the [DISPLAY] button on the remote control for 5 (five) seconds..

Keyboard control

Choose to enable or disable the display keyboard (control buttons) function.

- **{Unlock}** – Enable the keyboard function.
- **{Lock All}** / **{Lock all but Volume}** / **{Lock all but Power}** – Disable the keyboard function.

Tiling

With this function you can create a single large-screen matrix (video wall) that consists of up to **25** sets of this display (**up to 5-sets each on the vertical and horizontal side**). This function requires a daisy-chain connection.

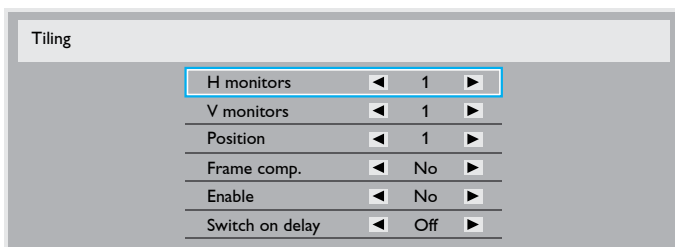

Example: 2 × 2 screen matrix (4 displays)

H monitors = 2 displays

V monitors = 2 displays

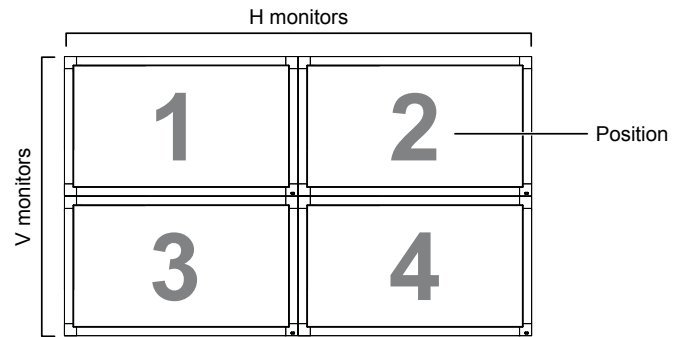

Example: 5 × 5 screen matrix (25 displays)

H monitors = 5 displays

V monitors = 5 displays

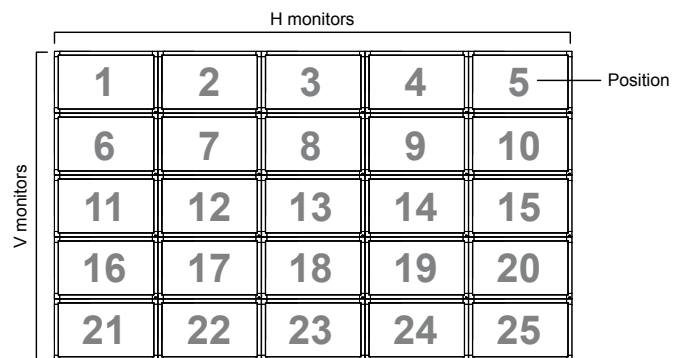

- **H monitors** – Select the number of displays on the horizontal side.
- **V monitors** – Select the number of displays on the vertical side.
- **Position** – Select the position of this display in the screen matrix.
- **Frame comp.** – Choose to turn the frame compensation function on or off. If selected **{Yes}**, the display will adjust the image to compensate for the width of the display bezels in order to accurately display the image.

Frame comp. – {Yes}

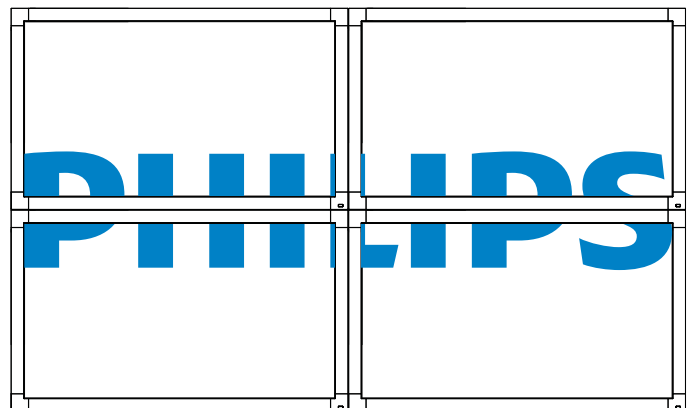

Frame comp. – {No}

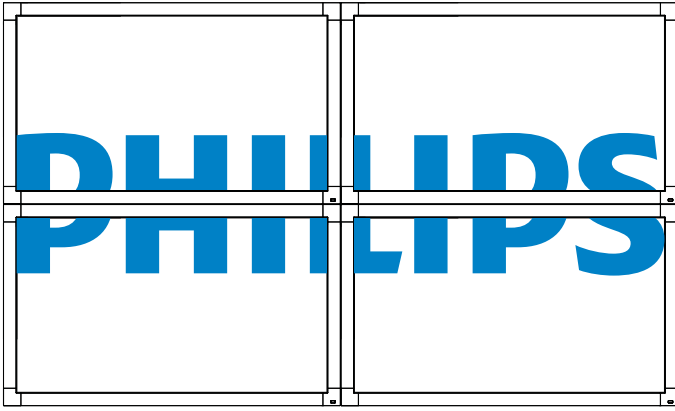

- **Enable:** Choose to enable or disable the Tiling function. If enabled, the display will apply the settings in {H monitors}, {V monitors}, {Position}, and {Frame comp.}.
- **Switch on delay:** Set the power-on delaying time (in seconds). The default option {Auto} allows a sequential powering-on for each display by their ID number when multiple displays are connected. The options are: {Off / Auto / 2, 4, 6, 8, 10, 20, 30, 40, 50}

NOTE: The Tiling function will be disabled when the [ON/OFF] button for PIP is pressed.

Heat status

This function allows you to check the thermal status of the display at any time.

Date and time

Adjust the current date and time for the display's internal clock.

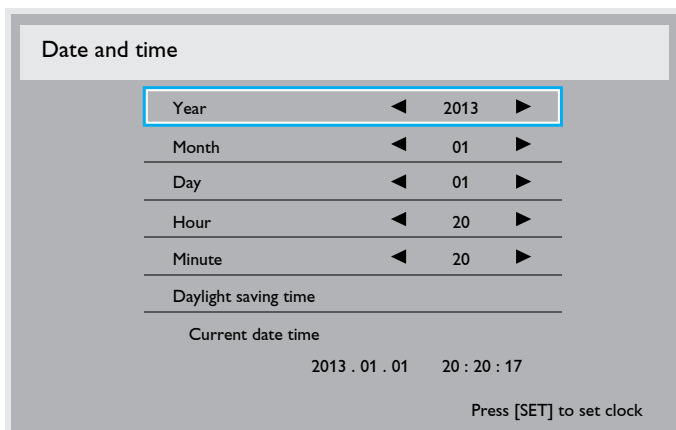

1. Press [+] button to enter the submenu.
2. Press [▲] or [▼] button to toggle between {Year}, {Month}, {Day}, {Hour}, {Minute}, and {Daylight saving time}.
3. Press [+] or [-] button to adjust all settings except {Daylight saving time}.
4. Press [SET] button to enter the {Daylight saving} submenu.
5. Press [+] or [-] button to select item, press [▲] or [▼] button to adjust.

Schedule

This function allows you to program up to 7 (seven) different scheduled time intervals for the display to activate.

You can select:

- The time for the display to turn on and turn off.
- The days in a week for the display to activate.

- Which input source the display will use for each scheduled activation period.

NOTE: We recommend you to set up current date and time in the {Date and time} menu before using this function.

1. Press [SET] or [+] button to enter the submenu.

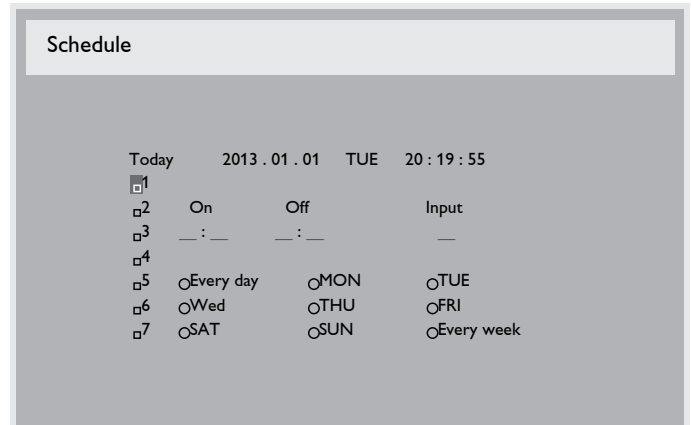

2. Press [▲] or [▼] button to select a schedule item (item number 1 ~ 7), and then press [+] button to mark it the item number.

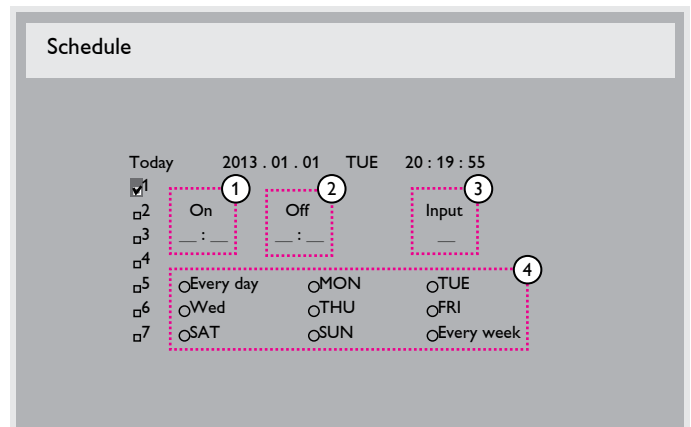

3. Press [+] or [-] button to select the schedule:
 - ① **Power-on** schedule: Press [▲] or [▼] button to set the hour and minute for the display to turn on.
 - ② **Power-off** schedule: Press [▲] or [▼] button to set the hour and minute for the display to turn off. Select or leave an empty “_” for both the hour and minute slot if you do not want to use this power-on or power-off schedule.
 - ③ **Input-source** selection: Press [▲] or [▼] button to select an input source. If no input source is selected, the input source will remain the same as last selected.
 - ④ **Date** schedule: Press [+] button to select which day in a week this schedule item will be take effect, and then press the [SET] button.
4. For additional schedule settings, press [EXIT], then repeat the steps above. A check mark in the box next to the number of the schedule item indicates that the selected schedule is in effect.

NOTES:

- The {Every day} selection in a schedule item takes priority over the other weekly schedules.
- If the schedules overlap, the scheduled power-on time takes priority over scheduled power-off time.

- If there are two schedule items programmed for the same time, the highest numbered schedule takes priority. For example, if schedule items #1 and #2 both set the display to power on at 7:00 AM and off at 5:00 PM, then only schedule item # 1 will take effect.

Monitor ID

Set the ID number for controlling the display via the RS232C connection. Each display must have a unique ID number when multiple sets of this display are connected. The monitor ID number range is between 1 to 26.

DDC/CI

Choose to turn on or off the DDC/CI communication function. Select **{On}** for normal use.

DDC/CI (Command Interface) specifies a means for a computer to send commands to the monitor, as well as receive sensor data from the monitor, over the bidirectional link such as DDC2Ab/Bi/B+.

Specific commands to control monitors are defined in a separate Monitor Control Command Set (MCCS) standard.

DDC/CI monitors are sometimes supplied with an external color sensor to allow automatic calibration of the monitor's color balance.

Some tilting DDC/CI monitors support an auto pivot function, where a rotation sensor in the monitor enables the operating system to keep the display upright as the monitor is moved between its portrait and landscape positions.

The following DDC/CI commands should be supported via command line:

No.	Commands
1	Set Brightness
2	set Contrast
3	Set Red Gain
4	Set Green Gain
5	Set Blue Gain
6	Get Brightness
7	Get Contrast
8	Get Red Gain
9	Get Green Gain
10	Get Blue

Smart power

Set the display to reduce the power consumption automatically.

The options are: **{Off}** / **{Medium}** / **{High}**.

Auto signal detection

Choose to let the display detect and display available signal sources automatically.

- **{On}** – Set the display to display the image automatically once a signal is connected.
- **{Off}** – Once a signal is connected, it can only be selected manually.

APM (Advanced Power Management)

Turn on or off the automatic power management setting.

- **{Off}** – Shutdown power directly if no signal detected. (Default)
- **{On}** – Enter power saving mode if no signal detected.

OPS settings

Set the OPS configuration under each power condition.

- **{Auto}** – After selecting **{Card OPS}** for video source input, the OPS will be set to off when the display power is set to off, or set to

on when the display power is set to on. When set to other video source inputs, the OPS will always be set to on.

- **{Always off}** – The OPS will always be set to off.
- **{Always on}** – The OPS will always be set to on.

Advanced option reset

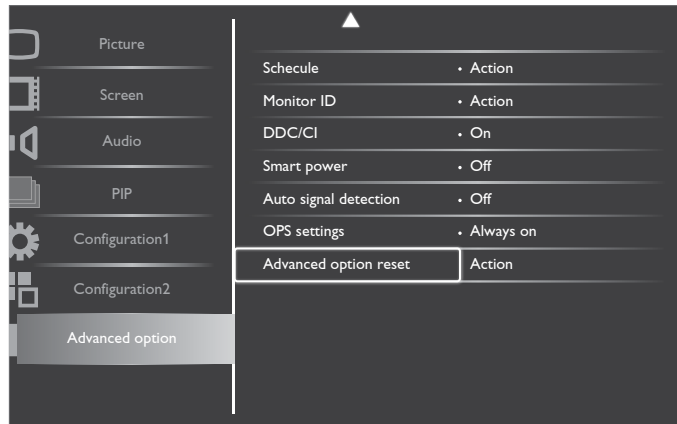

Reset all settings in the **Advanced option** menu to factory preset values.

1. Press **[SET]** or **[+]** button to enter the submenu.
2. Press **[+]** or **[-]** button to select **{Reset}** and press the **[SET]** button to restore settings to factory preset values.
3. Press the **[EXIT]** button or select **{Cancel}** and press the **[SET]** button to cancel and then return to the previous menu.

5. Input Mode

PC Resolution:

Standard Resolution	Active Resolution		Refresh Rate	Pixel Rate	Aspect Ratio	Stand for Mode
	H Pixels	V Lines				
VGA	640	480	60 Hz	25.175 MHz	4:3	Video Graphic Array
		480	72 Hz	31.5 MHz		
		480	75 Hz	31.5 MHz		
WVGA	720	400	70 Hz	33.75 MHz	16:9	Wide Video Graphic Array
SVGA	800	600	60 Hz	40 MHz	4:3	Super VGA
		600	75 Hz	49.5 MHz		
XGA	1024	768	60 Hz	65 MHz	4:3	Extended Graphic Array
		768	75 Hz	78.75 MHz		
WXGA	1280	768	60 Hz	79.5 MHz	5:3	Wide XGA
WXGA	1280	800	60 Hz	79.5 MHz	16:10	Wide XGA
SXGA	1280	960	60 Hz	108 MHz	4:3	Super XGA
SXGA	1280	1024	60 Hz	108 MHz	5:4	Super XGA
WXGA	1360	768	60 Hz	85.5 MHz	16:9	Wide XGA
WXGA	1366	768	60 Hz	85.5 MHz	16:9	Wide XGA
UXGA	1600	1200	60 Hz	162 MHz	4:3	Ultra XGA
HD1080	1920	1080	60 Hz	148.5 MHz	16:9	HD1080

SDTV Resolution:

Standard Resolution	Active Resolution		Refresh Rate	Pixel Rate	Aspect Ratio	Stand for Mode
	H Pixels	V Lines				
480i	720	480	29.97 Hz	13.5 MHz	4:3	Modified NTSC Standard
480p			59.94 Hz	27 MHz		
576i	720	480	25 Hz	13.5 MHz	4:3	Modified PAL Standard
576p			50 Hz	27 MHz		

HDTV Resolution:

Standard Resolution	Active Resolution		Refresh Rate	Pixel Rate	Aspect Ratio	Stand for Mode
	H Pixels	V Lines				
720p	1280	720	50 Hz	74.25 MHz	16:9	Normally DVB Mode
			60 Hz			
1080i	1920	1080	25 Hz	74.25 MHz	16:9	Normally ATSC Mode
			30 Hz			
1080p	1920	1080	50 Hz	148.5 MHz	16:9	Normally ATSC Mode
			60 Hz			

- The PC text quality is optimum in HD 1080 mode (1920 × 1080, 60 Hz).
- Your PC display screen might appear different depending on the manufacturer (and your particular version of Windows).
- Check your PC instruction book for information about connecting your PC to a display.
- If a vertical and horizontal frequency-select mode exists, select 60 Hz (vertical) and 31.5 KHz (horizontal). In some cases, abnormal signals (such as stripes) might appear on the screen when the PC power is turned off (or if the PC is disconnected). If so, press the [INPUT] button to enter the video mode. Also, make sure that the PC is connected.
- When horizontal synchronous signals seem irregular in RGB mode, check PC power saving mode or cable connections.
- The display settings table complies to the IBM/VESA standards, and based on the analog input.
- The DVI support mode is regarded as same to the PC support mode.
- The best timing for the vertical frequency to each mode is 60 Hz.

6. Pixel Defect Policy

We strive to deliver the highest quality products and use some of the industry's most advanced manufacturing processes whilst practicing stringent quality control. However, pixel or sub-pixel defects on the PDP / TFT panels used in Plasma- & LCD- displays are sometimes unavoidable. No manufacturer can guarantee that all panels will be free from pixel defects, but Philips guarantees that any Plasma- & LCD- displays with an unacceptable number of defects will be repaired during the warranty period in line with your local guarantee conditions.

This notice explains the different types of pixel defects and defines the acceptable defect level for the BDL6520EL LCD screen. In order to qualify for repair under warranty, the number of pixel defects must exceed a certain level as shown in the reference table. If the LCD screen is within specification a warranty exchange / claim back will be refused. Additionally, because some types or combinations of pixel defects are more noticeable than others, Philips sets even higher quality standards for those.

6.1. Pixels and Sub-Pixels

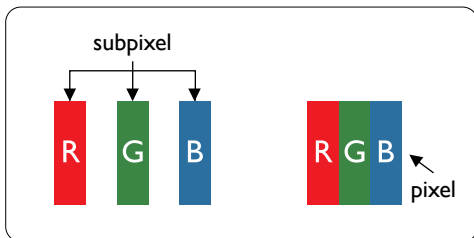

A pixel, or picture element, is composed of three sub-pixels in the primary colors of red, green and blue. Many pixels together form an image. When all sub-pixels of a pixel are lit, the three colored sub-pixels together appear as a single white pixel. When all are dark, the three colored sub-pixels together appear as a single black pixel. Other combinations of lit and dark sub-pixels appear as single pixels of other colors.

6.2. Types of Pixel Defects + Dot Definition

Pixel and sub-pixel defects appear on the screen in different ways. There are three categories of pixel defects and several types of sub-pixel defects within each category.

Dot definition = What is a defective "Dot"?

One or more defective, adjacent sub-pixel are defined as one "dot". The no. of defective sub-pixels are not relevant to define a defective dot. This means that a defective dot can consist of one, two or three defective sub-pixels which can be dark or lit.

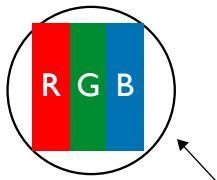

One dot = One Pixel; consists of three sub-pixels of Red, Green, and Blue.

6.3. Bright Dot Defects

Bright dot defects appear as pixels or sub-pixels that are always lit or "on". These are the examples of bright dot defects:

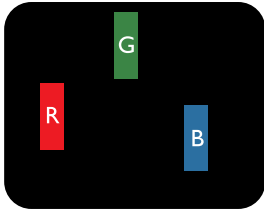
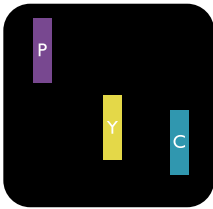
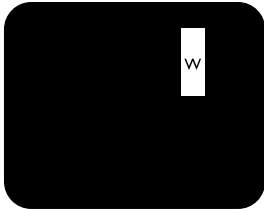
 <p>One lit red, green or blue sub pixel</p>	 <p>Two adjacent lit sub pixels: Red + Blue = Purple Red + Green = Yellow Green + Blue = Cyan (Light Blue)</p>	 <p>Three adjacent lit sub pixels (one white pixel)</p>
---	---	--

6.4. Dark Dot Defects

Black dot defects appear as pixels or sub-pixels that are always dark or "off". These are the examples of black dot defects:

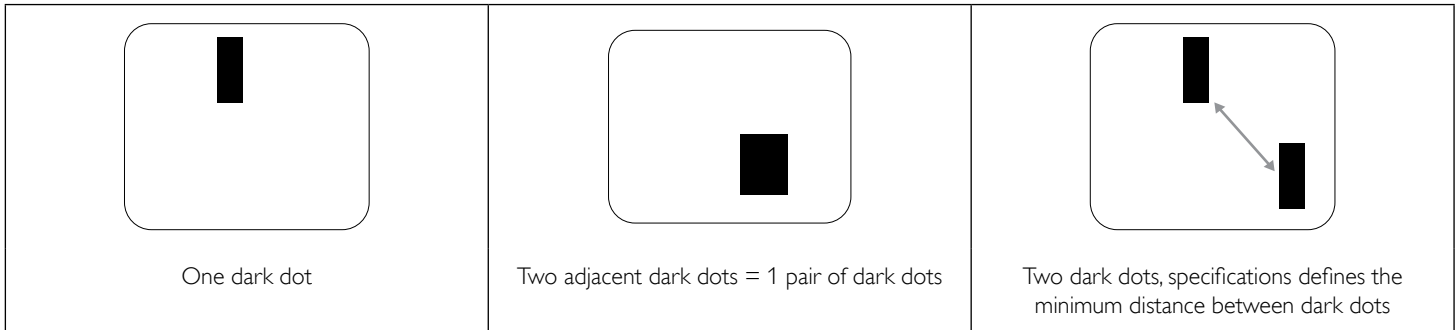

6.5. Proximity of Pixel Defects

Because pixel and sub-pixels defects of the same type that are nearby one another may be more noticeable, Philips also specifies tolerances for the proximity of pixel defects. In the table below you can find specifications about:

- Allowed amount of adjacent dark dots = (adjacent dark dots = 1 pair of dark dots)
- Minimum distance between dark dots
- Total no. of all defective dots

6.6. Pixel Defect Tolerances

In order to qualify for repair due to pixel defects during the warranty period, a PDP / TFT panel in a Philips Plasma / LCD- display must have pixel or sub-pixel defects exceeding the tolerances listed in the following table.

BRIGHT DOT EFFECT	ACCEPTABLE LEVEL
1 lit sub pixel	2
BLACK DOT EFFECT	ACCEPTABLE LEVEL
1 dark sub pixel	10
TOTAL DOT DEFECTS OF ALL TYPES	12

NOTE: * 1 or 2 adjacent sub pixel defects = 1 dot defect

6.7. MURA

Dark spots or patches may occasionally appear on some liquid crystal display (LCD) panels. This is known within the industry as Mura, which is a Japanese term for "unevenness." It is used to describe an irregular pattern or area in which uneven screen uniformity appears under certain conditions. Mura is a result of the deterioration of the liquid crystal alignment layer and is most commonly caused by long-term operation under high ambient temperatures. It is an industry- wide phenomenon and Mura is not repairable. It is also not covered by our warranty terms.

Mura has been around since the introduction of LCD technology and with screens getting bigger and in operation 24/7, many displays are running in low light conditions. This all adds to the possibility of Mura affecting displays.

HOW TO SPOT MURA

There are many symptoms of Mura and also multiple causes. Several of these are listed below:

- Impurities or foreign particles in the crystal matrix
- Uneven distribution of LCD matrix during manufacturing
- Non-uniform luminance distribution of the backlight
- Panel assembly induced stress
- Flaws within the LCD cells
- Thermal induced stress – high temperature operation over long periods of time

HOW TO AVOID MURA

Although we can not guarantee the complete eradication of Mura every time, in general the appearance of Mura can be minimized by these methods:

- Lower the backlight brightness
- Use a screen saver
- Reduce the ambient temperature around the unit

7. Cleaning and Troubleshooting

7.1. Cleaning

Caution When Using the Display

- Do not bring your hands, face or objects close to the ventilation holes of the display. The top of the display is usually very hot due to the high temperature of exhaust air being released through the ventilation holes. Burns or personal injuries may occur if any body parts are brought too close. Placing any object near the top of the display could also result in heat related damage to the object as well as the display itself.
- Be sure to disconnect all cables before moving the display. Moving the display with its cables attached may damage the cables and thus cause fire or electric shock.
- Disconnect the power plug from the wall outlet as a safety precaution before carrying out any type of cleaning or maintenance procedure.

Front Panel Cleaning Instructions

- The front of the display has been specially treated. Wipe the surface gently using only a cleaning cloth or a soft, lint-free cloth.
- If the surface becomes dirty, soak a soft, lint-free cloth in a mild detergent solution. Wring the cloth to remove excess liquid. Wipe the surface of the display to remove dirt. Then use a dry cloth of the same type to dry.
- Do not scratch or hit the surface of the panel with fingers or hard objects of any kind.
- Do not use volatile substances such as insect sprays, solvents and thinners.

Cabinet Cleaning Instructions

- If the cabinet becomes dirty, wipe the cabinet with a soft, dry cloth.
- If the cabinet is extremely dirty, soak a lint-free cloth in a mild detergent solution. Wring the cloth to remove as much moisture as possible. Wipe the cabinet. Use another dry cloth to wipe over until the surface is dry.
- Do not allow any water or detergent to come into contact with the surface of the display. If water or moisture gets inside the unit, operating problems, electrical and shock hazards may result.
- Do not scratch or hit the cabinet with fingers or hard objects of any kind.
- Do not use volatile substances such as insect sprays, solvents and thinners on the cabinet.
- Do not place anything made from rubber or PVC near the cabinet for any extended periods of time.

7.2. Troubleshooting

Symptom	Possible Cause	Remedy
No picture is displayed	<ol style="list-style-type: none"> 1. The power cord is disconnected. 2. The main power switch on the back of the display is not switched on. 3. The selected input has no connection. 4. The display is in standby mode. 	<ol style="list-style-type: none"> 1. Plug in the power cord. 2. Make sure the power switch is switched on. 3. Connect a signal connection to the display.
Interference displayed on the display or audible noise is heard	Caused by surrounding electrical appliances or fluorescent lights.	Move the display to another location to see if the interference is reduced.
Color is abnormal	The signal cable is not connected properly.	Make sure that the signal cable is attached firmly to the back of the display.
Picture is distorted with abnormal patterns	<ol style="list-style-type: none"> 1. The signal cable is not connected properly. 2. The input signal is beyond the capabilities of the display. 	<ol style="list-style-type: none"> 1. Make sure that the signal cable is attached firmly. 2. Check the video signal source to see if it is beyond the range of the display. Please verify its specifications with this display's specification section.
Display image doesn't fill up the full size of the screen	The zoom mode is not correctly set.	Use the Zoom mode or Custom zoom function in the Screen menu to fine tune display geometry and time frequency parameter.
Can hear sound, but no picture	Improperly connected source signal cable.	Make sure that both video inputs and sound inputs are correctly connected.
Can see picture but no sound is heard	<ol style="list-style-type: none"> 1. Improperly connected source signal cable. 2. Volume is turned all the way down. 3. [MUTE] is turned on. 4. No external speaker connected. 	<ol style="list-style-type: none"> 1. Make sure that both video inputs and sound inputs are correctly connected. 2. Press [VOL UP] or [VOL DOWN] button to hear sound. 3. Switch MUTE off by using the [MUTE] button. 4. Connect external speakers and adjust the volume to a suitable level.
Some picture elements do not light up	Some pixels of the display may not turn on.	This display is manufactured using an extremely high level of precision technology; however, sometimes some pixels of the display may not display. This is not a malfunction.
After-Images can still be seen on the display after the display is powered off. (Examples of still pictures include logos, video games, computer images, and images displayed in 4:3 normal mode)	A still picture is displayed for an over extended period of time	Do not allow a still image to be displayed for an extended period of time as this can cause a permanent after-image to remain on the display.

8. Technical Specifications

Display:

Item	Specifications
Screen Size (Active Area)	65" LCD (165.1 cm)
Aspect Ratio	16:9
Number of Pixels	1920 (H) × 1080 (V)
Pixel Pitch	0.744 (H) × 0.744 (V) [mm]
Displayable Colors	1.07 Billion colors
Brightness (typical)	360 cd/m ²
Contrast Ratio (typical)	4000:1
Viewing Angle	178 degrees

In/Out Terminals:

Item	Specifications
Speaker Output	Internal Speakers External Speakers
	10W (L) + 10W (R) [RMS]/8Ω 1 Way 1 Speaker System 82 dB/W/M/160 Hz ~ 13 KHz
Audio Output	RCA Jack × 2
	0.5V [rms] (Normal) / 2 Channel (L+R)
Audio Input	3.5 mm Stereo × 1 RCA Jack × 4
	0.5V [rms] (Normal) / 2 Channel (L+R)
RS232C Input/Output	D-Sub Jack × 2 (9 pin)
	TXD + RXD (1:1)
LAN	RJ-45 Jack × 1 (8 pin)
	10/100 LAN Port
HDMI Input	HDMI Jack × 1 (Type A) (19 pin)
	Digital RGB: TMDS (Video + Audio) MAX: Video: 720p, 1080p, 1920 × 1080/60 Hz (WUXGA) Audio: 48 KHz / 2 Channel (L+R) Supports LPCM only
DVI-D Input	DVI-D jack
	Digital RGB: TMDS (Video)
VGA Input	D-Sub Jack × 1 (15 pin)
	Analog RGB: 0.7V [p-p] (75Ω), H/CS/V: TTL (2.2kΩ), SOG: 1V [p-p] (75Ω) MAX: 720p, 1080p, 1920 × 1080/60 Hz (WUXGA)
VGA Output	D-Sub Jack × 1 (15 pin)
	Analog RGB: 0.7V [p-p] (75Ω), H/CS/V: TTL (2.2kΩ), SOG: 1V [p-p] (75Ω) MAX: 720p, 1080p, 1920 × 1080/60 Hz (WUXGA)
Component Input	BNC Jack × 3
	Y: 1V [p-p] (75Ω), Pb: 0.7V [p-p] (75Ω), Pr: 0.7V [p-p] (75Ω) MAX: 480i, 576i, 480p, 576p, 720p, 1080i, 1080p
VIDEO Input	S-VIDEO Jack × 1 BNC Jack × 1
	Y: 1V [p-p] (75Ω), C: 0.3V [p-p] (75Ω) Composite 1V [p-p] (75Ω)
VIDEO Output	BNC Jack × 1
	Composite 1V [p-p] (75Ω)

General:

Item	Specifications
Power Input	100-240V \sim 50-60Hz, 6.0-4.0A
Power Output	100-240V \sim 50-60Hz, 2A
Power Consumption (Max)	TBD 330 W (With OPS)
Power Consumption (typ.)	TBD 250 W (Without OPS)
Power Consumption (Standby & Off)	< 0.5W (OSD: APM mode off)
Dimensions [W × H × D]	1552 × 927.1 × 93 mm
Weight	52 Kg
Gross Weight	67.5 Kg (Reference only)

Environmental Condition:

Item		Specifications
Temperature	Operational	0 ~ 40°C
	Storage	-20 ~ 60°C
Humidity	Operational	20 ~ 80% RH (No condensation)
	Storage	10 ~ 90% RH (No condensation)
Altitude	Operational	0 ~ 5,000 m
	Storage	0 ~ 9,000 m

Internal Speaker:

Item	Specifications
Type	1 Way 1 Speaker
Input	10 W (RMS)
Impedance	8Ω
Output Sound Pressure	82 dB/W/M
Frequency Response	160 Hz ~ 13 KHz



© 2013 Koninklijke Philips Electronics N.V. All rights reserved.

Philips and the Philips Shield Emblem are registered trademarks of Koninklijke Philips Electronics N.V. and are used under license from Koninklijke Philips Electronics N.V.

Specifications are subject to change without notice.