



KRAMER ELECTRONICS LTD.

USER MANUAL

MODEL:

WP-577VH

Wall Plate

P/N: 2900-30031 1 Rev 2



WP-577VH Wall Plate Quick Start Guide

This guide helps you install and use your product for the first time. For more detailed information, go to http://www.kramerelectronics.com/support/product_downloads.asp to download the latest manual or scan the QR code on the left.

Step 1: Check what's in the box

- WP-577VH HDMI and PC Graphics Wall Plate
- 1 Quick start guide
- Power adapter (12V DC)



Save the original box and packaging materials in case your Kramer product needs to be returned to the factory for service.

Step 2: Connect the outputs

Always switch off the power to all devices before connecting them to your WP-577VH.

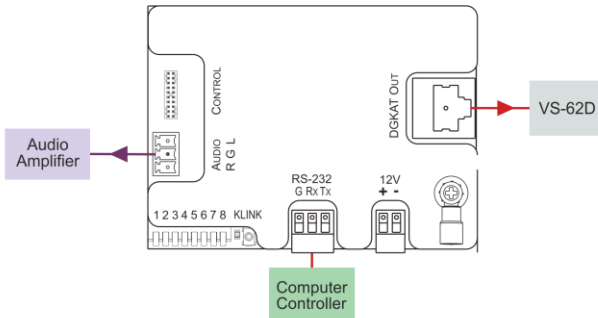

For optimum performance we recommend the Kramer **BC-DGKat524** (CAT 5 24 AWG), **BC-DGKat623** (CAT 6 23 AWG), and the **BC-DGKat7a23** (CAT 7a 23 AWG) cables. These specially built cables significantly outperform regular CAT 5/ CAT 6/CAT 7a cables.

Note: The WP-577VH cannot work with unshielded cables.

Step 3: Set the DIP-switches

#	Feature	Function	DIP-switch
1	Audio Mode Auto/Manual	Sets the audio selection mode. Note: This setting has no effect when the PC graphics source is selected	On—Auto Off—Manual
2	Video Mode Auto/Manual	Sets the video selection mode	On—Auto Off—Manual
3	Input Priority Mode	Sets the video input automatic selection mode. Note: This selection is available only if DIP-switch 2 is set to Auto	On—Priority Off—Last connected
4	Audio Mode Manual	Sets the audio selection mode, (see table below)	On—Force embedded Off—Force analog
5	EDID Lock	Sets the EDID mode	On—Lock the EDID Off—Automatic EDID acquisition
6, 7, 8	Reserved		

DIP-switch #1	DIP-switch #4	Analog Audio Present	Audio Used
On	Not relevant	Yes	Analog
		No	HDMI
Off	On	Not relevant	HDMI
Off	Off	Yes	Analog
		No	Analog (mute)

Step 4: Connect the inputs

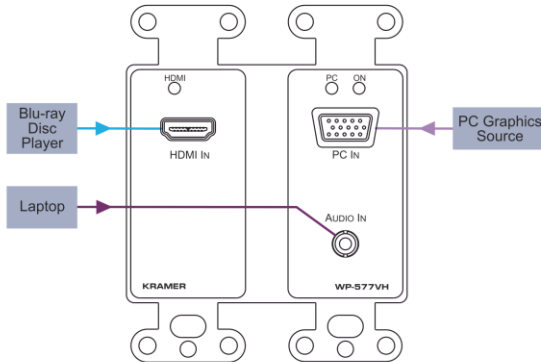

Step 5: Connect the power



If required, connect the power adapter to the WP-577VH and plug the adapter into the mains electricity.

Step 6: Install the WP-577VH

Mount the device in a suitable wall box.

Contents

1	Introduction	1
2	Getting Started	2
2.1	Achieving the Best Performance	2
2.2	Safety Instructions	3
2.3	Recycling Kramer Products	3
3	Overview	4
3.1	Using TP cables	5
4	Defining the WP-577VH Wall Plate	7
4.1	Defining the WP-577VH	7
5	Connecting the WP-577VH	10
5.1	Connecting the RS-232 Serial Port to a Remote Device	11
6	Principles of Operation	12
6.1	Input Selection	12
6.2	Input Connection Timeout	13
6.3	Audio Signal Priority	13
6.4	K-Link Active and Passive Local RS-232 Data Modes	14
6.5	K-Link Active and Passive DGKat RS-232 Data Modes	15
7	Operating the WP-577VH	17
7.1	Selecting an Input	17
7.2	K-Link: Selecting Active or Passive Local RS-232 Data Mode	17
7.3	Selecting Active or Passive DGKat RS-232 Data Mode	18
8	Configuring and Maintaining the WP-577VH	19
8.1	Setting the Configuration DIP-switch	19
8.2	Updating the Firmware	20
9	Wiring the DGKat TP RJ-45 Connectors	21
10	Technical Specifications	22
10.1	Default Communication Parameters	22
11	Protocol 3000	23
11.1	Kramer Protocol 3000 Syntax	23
11.2	Kramer Protocol 3000 Commands	26

Figures

Figure 1:	WP-577VH Wall Plate Front Panel	7
Figure 2:	WP-577VH Wall Plate Rear Panel	9
Figure 3:	Connecting the WP-577VH Wall Plate	10
Figure 4:	Connecting the RS-232 Serial Port to a Remote Device	11
Figure 5:	Sample Setup using Active Mode from the Local RS-232 Port	14
Figure 6:	Sample Setup using Passive Mode	15
Figure 7:	Sample Setup using Active Mode over the Remote DGKat Link	16
Figure 8:	The Configuration DIP-switch	19
Figure 9:	TP Pinout Wiring	21

1 Introduction

Welcome to Kramer Electronics! Since 1981, Kramer Electronics has been providing a world of unique, creative, and affordable solutions to the vast range of problems that confront video, audio, presentation, and broadcasting professionals on a daily basis. In recent years, we have redesigned and upgraded most of our line, making the best even better!

Our 1,000-plus different models now appear in 13 groups that are clearly defined by function: GROUP 1: Distribution Amplifiers; GROUP 2: Switchers and Routers; GROUP 3: Control Systems; GROUP 4: Format/Standards Converters; GROUP 5: Range Extenders and Repeaters; GROUP 6: Specialty AV Products; GROUP 7: Scan Converters and Scalers; GROUP 8: Cables and Connectors; GROUP 9: Room Connectivity; GROUP 10: Accessories and Rack Adapters and GROUP 11: Sierra Video Products; GROUP 12: Digital Signage; and GROUP 13: Audio, and GROUP 14: Collaboration.

Congratulations on purchasing your Kramer **WP-577VH/WP-577VHE** *Wall Plate* transmitter which is ideal for the following typical applications:

- Small to medium to small boardroom connectivity
- Interfacing with a variety of source to remote displays in schools and businesses
- Hotel rooms
- “Bring-your-own” laptop environments

2 Getting Started

We recommend that you:

- Unpack the equipment carefully and save the original box and packaging materials for possible future shipment
- Review the contents of this user manual



Go to http://www.kramerelectronics.com/support/product_downloads.asp to check for up-to-date user manuals, application programs, and to check if firmware upgrades are available (where appropriate).

2.1 Achieving the Best Performance

To achieve the best performance:

- Use only good quality connection cables (we recommend Kramer high-performance, high-resolution cables) to avoid interference, deterioration in signal quality due to poor matching, and elevated noise levels (often associated with low quality cables)
- Do not secure the cables in tight bundles or roll the slack into tight coils
- Avoid interference from neighboring electrical appliances that may adversely influence signal quality
- Position your Kramer **WP-577VH Wall Plate** away from moisture, excessive sunlight and dust



This equipment is to be used only inside a building. It may only be connected to other equipment that is installed inside a building.

2.2 Safety Instructions



Caution: There are no operator serviceable parts inside the unit

Warning: Use only the Kramer Electronics input power wall adapter that is provided with the unit

Warning: Disconnect the power and unplug the unit from the wall before installing

2.3 Recycling Kramer Products

The Waste Electrical and Electronic Equipment (WEEE) Directive 2002/96/EC aims to reduce the amount of WEEE sent for disposal to landfill or incineration by requiring it to be collected and recycled. To comply with the WEEE Directive, Kramer Electronics has made arrangements with the European Advanced Recycling Network (EARN) and will cover any costs of treatment, recycling and recovery of waste Kramer Electronics branded equipment on arrival at the EARN facility. For details of Kramer's recycling arrangements in your particular country go to our recycling pages at <http://www.kramerelectronics.com/support/recycling/>.

3 Overview

The **WP-577VH** accepts the following signals:

- HDMI and PC graphics video
- Unbalanced, stereo audio
- An RS-232 control or data signal

The **WP-577VH** encodes these signals and transmits the encoded signal via DGKat cable to a compatible DGKat switcher or receiver (for example, the **TP-578HDCP**, **TP-574** or **PT-572+**). The stereo audio can be embedded into the output signal.

Using the **WP-577VH**, you can also communicate via the twisted pair cable:

- EDID (Extended Display Information Data)
- HPD (Hot Plug Detect) signals from the display device to the source to trigger the auto-switching facility

The **WP-577VH** features:

- HDCP support
- HDTV compatibility
- Support for HDMI with x.v. Color™ and 3D
- Support for digital audio formats
- Automatic live input detection based on 5V presence (HPD)
- Automatic switching capabilities to the last connected or priority video input
- Automatic analog audio detection and embedding, (auto detection may take up to 10 seconds)
- EDID PassThru – Passes EDID/HDCP signals from source to display

- Compatibility with all Kramer K-LINK devices which allows the use of RS-232 for both control of other Kramer devices and sending data to remote, external RS-232 devices
- Equalization and re-clocking of the data
- A maximum data rate of 4.95Gbps (1.65Gbps bandwidth per graphic channel)
- Support for Protocol 3000
- PowerConnectPlus—a single connection to the transmitter or receiver powers both units. The higher voltage PowerConnectPlus also powers regular PowerConnect devices via auto-negotiation

Note: The **WP-577VH** can supply power to PowerConnect devices but can only be powered by PowerConnectPlus devices.

The **WP-577VH** supports a range of:

- Up to 90m (295ft) at 1080i, or up to 30m (98ft) at 1080p on shielded **BC-DGKat524** cable
- Up to 90m (295ft) at 1080i, or up to 70m (230ft) at 1080p on shielded **BC-DGKat623** cable
- Up to 100m (330ft) at 1080i or up to 90m (295ft) at 1080p on shielded **BC-DGKat7a23** cable

Note: The transmission range depends on the signal resolution, graphics card and display used. The distance using non-Kramer CAT 6 and CAT 7a cables may not reach these ranges.

3.1 Using TP cables

Kramer engineers have developed special twisted pair cables to best match our digital twisted pair products; the Kramer **BC-DGKat524** (CAT 5 24 AWG), the Kramer **BC-DGKat623** (CAT 6 23 AWG), and the Kramer **BC-DGKat7a23** (CAT 7a 23 AWG) cables. These specially built cables significantly outperform regular CAT 5/CAT 6/CAT 7a cables.

Note: The **WP-577VH** cannot work with unshielded cables. The cable ground shield must be connected/soldered to the shield of both RJ-45 connectors.



Warning: Using a TP cable that is incorrectly wired will prevent Power ConnectPlus™ from working

4 Defining the WP-577VH Wall Plate

4.1 Defining the WP-577VH

Figure 1 defines the front panel of the WP-577VH.

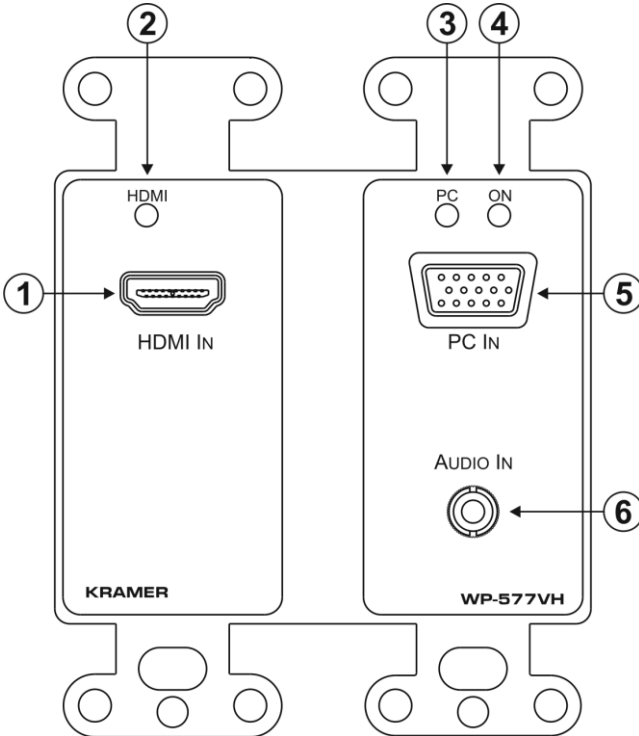

Figure 1: WP-577VH Wall Plate Front Panel

#	Feature	Function
1	HDMI IN Input Connector	Connect to the HDMI source
2	HDMI Signal LED	<p>Lights green when all the following are true:</p> <ul style="list-style-type: none"> The port is selected There is a valid HDMI signal present The signal is being routed via the DGKat output <p>Lights red when any of the following is true:</p> <ul style="list-style-type: none"> No signal is connected The signal is not valid Routing is not working

#	Feature	Function
3	<i>PC Graphics Signal LED</i>	<p>Lights green when all the following are true:</p> <ul style="list-style-type: none"> • The port is selected • There is a valid PC graphics signal present • The signal is being routed via the DGKat output <p>Lights red when any of the following is true:</p> <ul style="list-style-type: none"> • No signal is connected • The signal is not valid • Routing is not working
4	<i>ON LED</i>	<p>The LED indicates the following:</p> <ul style="list-style-type: none"> • Lights green—the device receives adequate power • Lights red—the power is insufficient
5	<i>PC IN Input Connector</i>	Connect to the PC graphics source
6	<i>AUDIO IN 3.5mm Mini Jack</i>	Connect to the unbalanced, stereo audio source

Figure 2 defines the rear panel of the WP-577VH.

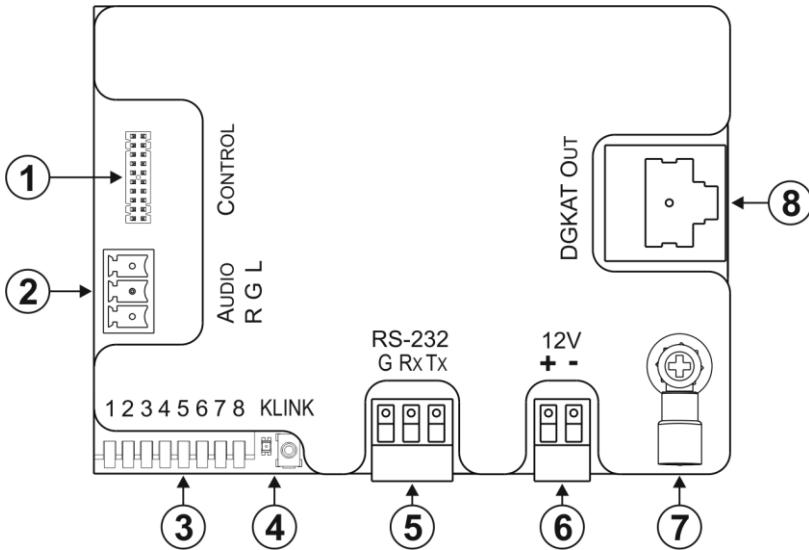

Figure 2: WP-577VH Wall Plate Rear Panel

#	Feature	Function
1	CONTROL Connector	For future use
2	AUDIO Out 3-pin Terminal Block	Connect to the unbalanced, stereo audio acceptor
3	SETUP 8-way DIP-switch	Sets the device behavior, (see Section 8.1)
4	K-LINK Mode Switch and LED	Press the switch to toggle between active and passive data modes for the local RS-232 port, (see Section 6.4). The LED indicates the following: <ul style="list-style-type: none"> Lights green—the device is in active mode, (the wallplate is being controlled) Lights red—the device is in passive mode, (the external device is being controlled)
5	RS-232 3-pin Terminal Block	Connect to a remote, serial signal source or acceptor (for example, a PC or a device to be controlled via a serial port). Note: Serial commands are transmitted even when the video signal is absent
6	12V DC Connector	Connect to the power adapter
7	Earth Terminal	Connect to the common ground (optional)
8	DGKat OUT RJ-45 TP Connector	Connect to a compatible DGKat TP switcher or receiver (for example, VS-62H or TP-578HDCP)

5 Connecting the WP-577VH



Always switch off the power to all devices before connecting them to your **WP-577VH**. After connecting your **WP-577VH**, connect its power and then switch on the power to the other devices.

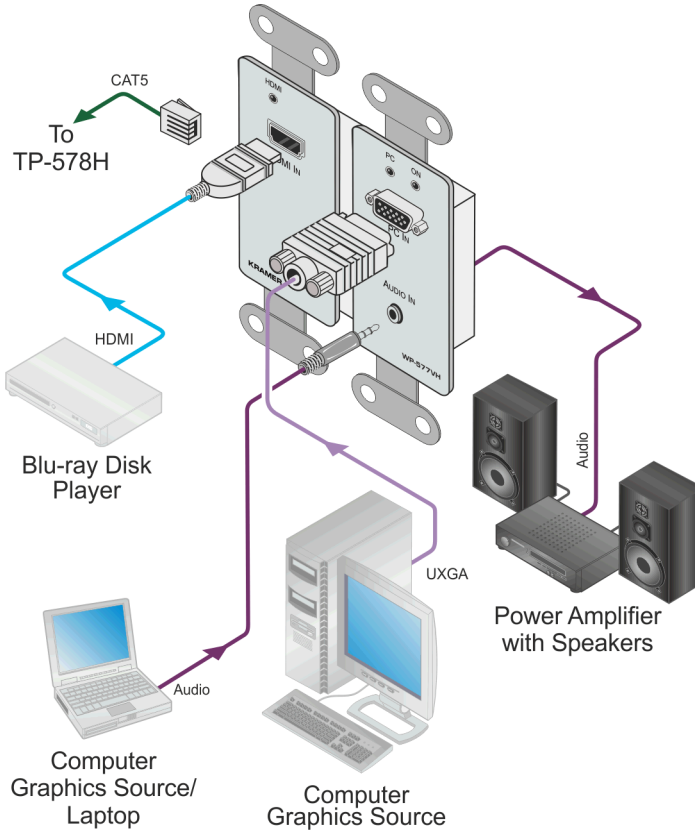

Figure 3: Connecting the WP-577VH Wall Plate

To connect the **WP-577VH** as illustrated in the example in [Figure 3](#):

1. Connect the DGKat Out RJ-45 connector on the **WP-577VH** to the Line In RJ-45 connector on the **TP-578H** using STP cable (see [Section 3.1](#)).

2. Connect the RS-232 3-pin terminal block on the rear of the **WP-577VH** to a remote serial device (controller or to be controlled).
3. If not using PowerConnect, connect the power adapter to the **WP-577VH** and to the mains electricity (not shown in [Figure 3](#)).
4. Connect an HDMI source, (for example, a Blu-ray disk player) to the HDMI input on the **WP-577VH**.
5. Connect a VGA source, (for example, a computer graphics source) to the PC In on the **WP-577VH**.
6. Connect an unbalanced, stereo audio source, (for example, the audio output of the laptop) to the Audio In 3.5mm mini jack on the **WP-577VH**.

5.1 Connecting the RS-232 Serial Port to a Remote Device

You can connect a serial controller or a device to be controlled to the RS-232 3-pin terminal block on the **WP-577VH**.

To connect a device to the RS-232 3-pin serial port:

- Connect the TX pin on the 3-pin terminal block to pin 2 (RX) on the 9-pin D-sub connector
- Connect the RX pin on the 3-pin terminal block to pin 3 (TX) on the 9-pin D-sub connector
- Connect the GND pin on the 3-pin terminal block to pin 5 (GND) on the 9-pin D-sub connector



Figure 4: Connecting the RS-232 Serial Port to a Remote Device

6 Principles of Operation

This chapter describes the principles of operation of the **WP-577VH** and comprises:

- Input selection (see [Section 6.1](#))
- Input connection timeout (see [Section 6.2](#))
- Audio signal priority (see [Section 6.3](#))
- Active and passive local RS-232 data modes (see [Section 6.4](#))
- Active and passive DGK at RS-232 data modes (see [Section 6.5](#))

The **WP-577VH** selects video and audio inputs based on the following rules.

6.1 Input Selection

The video selection mode is set by the DIP-switches (see [Section 8.1](#)) to:

- Manual (external control)
- Last connected
- Priority

In last connected mode the **WP-577VH** selects the input that was the last to be connected. In manual mode the input is selected by sending Protocol 3000 commands. An input selection made by sending a serial command overrides any other current selection.

In Priority mode the input is selected based on the order of priority which is set using the control application. The default order of priority is:

1. HDMI
2. VGA

This priority remains in force until any of the following occurs:

- A Protocol 3000 command is sent
- The input signals/connections change

6.2 Input Connection Timeout

The default delay when switching to a new source when either the active source is lost or a new source is connected is three seconds. The delay when the active source is lost or a new signal is connected can be changed independently using the relevant Protocol 3000 command, (see [Section 11.2](#)).

When the active source is lost, the delay can be set to between 3 seconds and unlimited. When a new signal is connected, the delay can be set to between 0 seconds (immediate) and unlimited.

6.3 Audio Signal Priority

The device can automatically detect an analog audio signal.

The audio selection mode is set using the DIP-switches (see [Section 8.1](#)) based on the following table.

DIP-switch #1	DIP-switch #4	Analog Audio Present	Audio Used
On	Not relevant	Yes	Analog
		No	HDMI
Off	On	Not relevant	HDMI
Off	Off	Yes	Analog
		No	Analog (=mute)

Note: During prolonged periods with no audio (10 seconds), the device may interpret this as having no analog audio present and therefore switch back to the embedded audio. To prevent this from occurring set audio selection to manual.

Note: Audio is transmitted even in the absence of video.

6.4 K-Link Active and Passive Local RS-232 Data Modes

The Local RS-232 port can be set to either active or passive mode.

1. In active mode, the data are treated as Protocol 3000 commands and these provide control of the **WP-577VH**.

[Figure 5](#) illustrates a sample setup when using the active mode from the local RS-232 port.

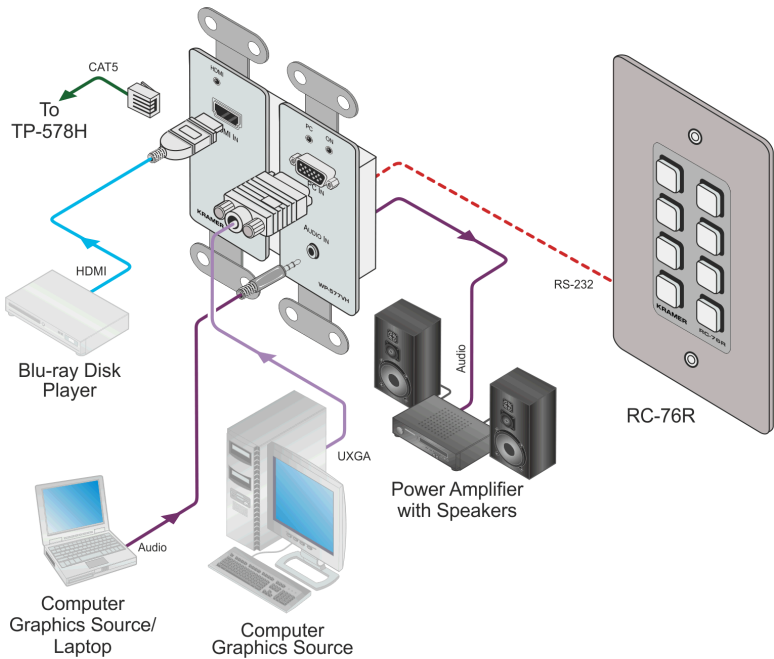

Figure 5: Sample Setup using Active Mode from the Local RS-232 Port

2. In passive mode, the data are treated as raw data and are transmitted over the DGKAt link with no local processing. This data can be used to either communicate with remote K-link devices (by sending Protocol 3000 commands and by setting the remote device to active mode), or it can be used to control an external device connected to the RS-232 port of a remote device (either a K-Link device set to passive mode or a legacy device, for example, the **TP-574**).

[Figure 6](#) illustrates a sample setup when using passive mode.

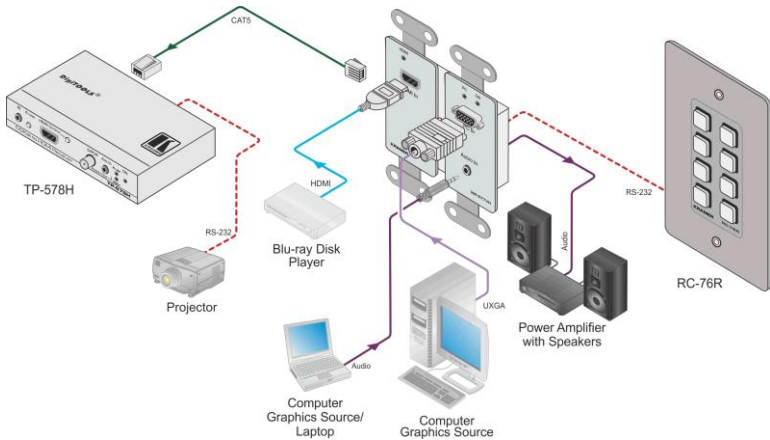

Figure 6: Sample Setup using Passive Mode

Note: In order for the passive mode to function, the RS-232 channel of the DGKat port must also be set to passive.

6.5 K-Link Active and Passive DGKat RS-232 Data Modes

The DGKat RS-232 port can be set to either active or passive mode.

1. In active mode, the data are treated as Protocol 3000 commands and these provide control of the **WP-577VH**.

[Figure 7](#) illustrates a sample setup when using active mode over the remote DGKat link.

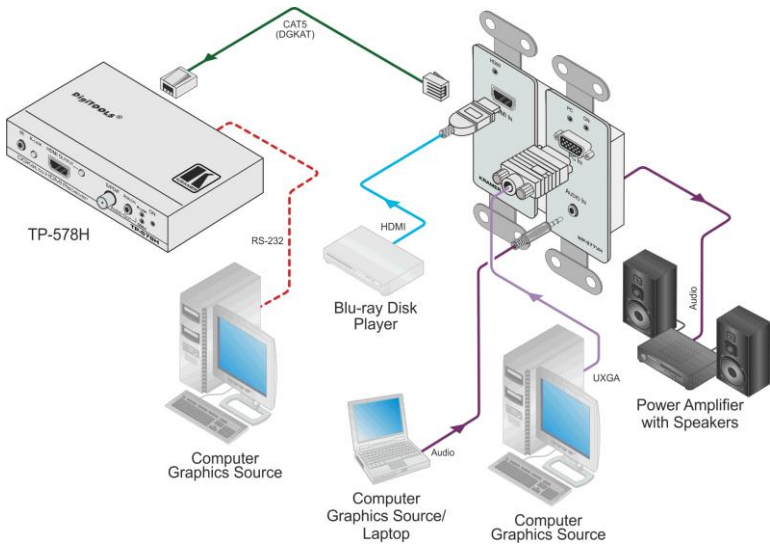

Figure 7: Sample Setup using Active Mode over the Remote DGKat Link

2. In passive mode, the data are treated as raw data and are transmitted over the DGKat link with no local processing. This data can be used to control an external device connected to the RS-232 port of a remote K-link device, (see [Section 6.4](#) for an illustration of the passive mode).

Note: In order for the passive mode to function, the RS-232 channel of the local port must also be set to passive.

7 Operating the WP-577VH

This chapter describes the operation of the **WP-577VH** and comprises:

- Selecting an input (see [Section 6.1](#))
- Selecting active or passive data modes (see [Section 7.2](#))

The **WP-577VH** selects video and audio inputs based on the rules described below.

7.1 Selecting an Input

To select an input in Manual mode:

- Send a Protocol 3000 serial command selecting the required input, (see [Section 11.2](#))

7.2 K-Link: Selecting Active or Passive Local RS-232 Data Mode

To switch between active and passive mode in local RS-232 data mode:

- Press the K-Link mode switch on the front panel, (the mode status is indicated by the K-Link LED)

–OR–

- Send the KLINK_INF (active mode)/KLINK_CLS (passive mode) Protocol 3000 command, (the mode status is indicated by the K-Link LED), see [Section 11.2](#)

Note: Protocol 3000 commands from the local RS-232 port need to be at 115200 baud rate, while data can only be sent at up to 9600 baud rate

Note: Data is still transmitted even in the absence of video and audio signals.

Note: In order for the passive mode to function, the RS-232 channel of the local port must also be set to passive.

7.3 Selecting Active or Passive DGKat RS-232 Data Mode

To switch between active and passive modes in DGKat RS-232 data mode:

- Send the KLINK_INF (active mode)/KLINK_CLS (passive mode) Protocol 3000 command at 9600, (see [Section 11.2](#))

Note: The mode status is **not** indicated by the K-Link LED.

Note: In order for the passive mode to function, the RS-232 channel of the local port must also be set to passive.

8 Configuring and Maintaining the WP-577VH

This chapter describes configuring and maintaining the **WP-577VH** and comprises:

- Setting the configuration DIP-switch (see [Section 6.1](#))
- Updating the firmware (see [Section 6.1](#))

8.1 Setting the Configuration DIP-switch

The 4-way dip-switch provides the ability to configure a number of device functions. Push a switch down to turn it on or up to turn it off.

Note: The device must be power-cycled whenever a change is made to the switches.

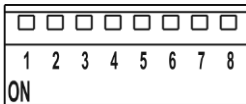

Figure 8: The Configuration DIP-switch

#	Feature	Function	DIP-switch
1	Audio Mode Auto/Manual	Sets the audio selection mode, (see table below). Note: This setting has no effect when the PC graphics source is selected	On—Auto Off—Manual
2	Video Mode Auto/Manual	Sets the video selection mode	On—Auto Off—Manual
3	Input Priority Mode	Sets the video input automatic selection. Note: This selection is available only if DIP-switch 2 is set to Auto	On—Priority Off—Last connected
4	Audio Mode Manual	Sets the audio selection mode, (see table below)	On—Force embedded Off—Force analog
5	Lock EDID	Locks the current EDID. When unlocked the EDID is acquired normally	On—Lock Off—Unlock
6	For future use		
7			
8			

DIP-switch #1	DIP-switch #4	Analog Audio Present	Audio Used
On	Not relevant	Yes	Analog
		No	HDMI
Off	On	Not relevant	HDMI
Off	Off	Yes	Analog
		No	Analog (=mute)

8.2 Updating the Firmware

The firmware is updated using the Kramer K-Upload software and by connecting via the RS-232 serial port. Refer to the *K-Upload User Guide* for more details.

9 Wiring the DGKat TP RJ-45 Connectors

Connect/solder the cable shield to the RJ-45 connector shield.



Do not use a crossed TP cable with this product.

Using a TP cable that is incorrectly wired may cause permanent damage to the device

Do not use unshielded TP cables with this product

[Figure 9](#) defines the TP pinout using a straight pin-to-pin cable with RJ-45 connectors.

EIA /TIA 568B	
PIN	Wire Color
1	Orange / White
2	Orange
3	Green / White
4	Blue
5	Blue / White
6	Green
7	Brown / White
8	Brown
Pair 1	4 and 5
Pair 2	1 and 2
Pair 3	3 and 6
Pair 4	7 and 8

Figure 9: TP Pinout Wiring

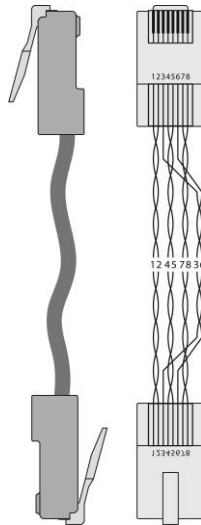

10 Technical Specifications

INPUTS:	1 HDMI on an HDMI connector 1 VGA on a 15-pin HD (F) connector 1 Unbalanced stereo audio on a 3.5mm mini jack
OUTPUT:	1 DGK at TP on an RJ-45 connector 1 Unbalanced audio on a 3-pin Terminal Block
PORTS:	1 Bidirectional serial RS-232 port on a 3-way terminal block
BANDWIDTH:	Up to 4.95Gbps (1.65Gbps bandwidth per graphic channel)
STANDARDS:	HDMI, x.v.Color™ and 3D HDCP
MAXIMUM TRANSMISSION DISTANCE:	90m (295ft) up to 1080p @60Hz
POWER CONSUMPTION:	12V DC, 700mA
OPERATING TEMPERATURE:	0° to +40°C (32° to 104°F)
STORAGE TEMPERATURE:	-40° to +70°C (-40° to 158°F)
HUMIDITY:	10% to 90%, RHL non-condensing
DIMENSIONS:	US: 8.79cm x 4.3cm x 10.47cm (3.46" x 1.69" x 4.12") W, D, H
WEIGHT:	0.2kg (0.44lbs) approx.
INCLUDED ACCESSORIES:	Power supply
Specifications are subject to change without notice at http://www.kramerelectronics.com	

10.1 Default Communication Parameters

RS-232	
Baud Rate	115,200
Data Bits	8
Stop Bits	1
Parity	None
Command Format	ASCII

11 Protocol 3000

The **WP-577VH** can be operated using serial commands from a PC, remote controller or touch screen using the Kramer Protocol 3000.

This section describes the:

- Kramer Protocol 3000 syntax (see [Section 11.1](#))
- Kramer Protocol 3000 commands (see [Section 11.2](#))

11.1 Kramer Protocol 3000 Syntax

11.1.1 Host Message Format

Start	Address (optional)	Body	Delimiter
#	<i>device_id@</i>	Message	CR

11.1.1.1 Simple Command

Command string with only one command without addressing:

Start	Body	Delimiter
#	Command SP <i>Parameter_1,Parameter_2,...</i>	CR

11.1.1.2 Command String

Formal syntax with commands concatenation and addressing:

Start	Address	Body	Delimiter
#	<i>device_id@</i>	Command_1 <i>Parameter1_1,Parameter1_2,...</i> Command_2 <i>Parameter2_1,Parameter2_2,...</i> Command_3 <i>Parameter3_1,Parameter3_2,...</i>	CR

11.1.2 Device Message Format

Start	Address (optional)	Body	delimiter
~	<i>device_id@</i>	Message	CR LF

11.1.2.1 Device Long Response

Echoing command:

Start	Address (optional)	Body	Delimiter
~	<i>device_id@</i>	Command SP [<i>Param1,Param2 ...</i>] result	CR LF

CR = Carriage return (ASCII 13 = 0x0D)

LF = Line feed (ASCII 10 = 0x0A)

SP = Space (ASCII 32 = 0x20)

11.1.3 Command Terms

Command

A sequence of ASCII letters ('A'-'Z', 'a'-'z' and '-').

Command and parameters must be separated by at least one space.

Parameters

A sequence of alphanumeric ASCII characters ('0'-'9', 'A'-'Z', 'a'-'z' and some special characters for specific commands). Parameters are separated by commas.

Message string

Every command entered as part of a message string begins with a **message starting character** and ends with a **message closing character**.

Note: A string can contain more than one command. Commands are separated by a pipe ('|') character.

Message starting character

'#' – For host command/query

'~' – For device response

Device ID (Optional, for K-NET)

K-NET Device ID followed by '@'

Query sign

'?' follows some commands to define a query request.

Message closing character

CR – For host messages; carriage return (ASCII 13)

CRLF – For device messages; carriage return (ASCII 13) + line-feed (ASCII 10)

Command chain separator character

When a message string contains more than one command, a pipe ('|') character separates each command.

Spaces between parameters or command terms are ignored.

11.1.4 Entering Commands

You can directly enter all commands using a terminal with ASCII communications software, such as HyperTerminal, Hercules, etc. Connect the terminal to the serial or Ethernet port on the Kramer device. To enter **CR** press the Enter key. (**LF** is also sent but is ignored by command parser).

For commands sent from some non-Kramer controllers like Crestron, some characters require special coding (such as, /X##). Refer to the controller manual.

11.1.5 Command Forms

Some commands have short name syntax in addition to long name syntax to allow faster typing. The response is always in long syntax.

11.1.6 Chaining Commands

Multiple commands can be chained in the same string. Each command is delimited by a pipe character (“|”). When chaining commands, enter the **message starting character** and the **message closing character** only once, at the beginning of the string and at the end.

Commands in the string do not execute until the closing character is entered.

A separate response is sent for every command in the chain.

11.1.7 Maximum String Length

64 characters

11.2 Kramer Protocol 3000 Commands

Command	Description
#	Protocol handshaking
AV	Switch audio and video
AV-SW-MODE	Set auto switch mode
AV-SW-TIMEOUT	Set auto switching timeout
BUILD-DATE?	Read device build date
CPEDID	Copy EDID data from the output to the input
DIR	List files in device
DISPLAY	Valid / Invalid output
FACTORY	Reset to factory default configuration
FS-FREE?	Get file system free space
GEDID	Read EDID data
HDCP-MOD?	Get HDCP mode
HDCP-STAT?	Get HDCP signal status
HELP	Get command list
KLINK_CLS	Set K-Link data mode
KLINK_INF	Set K-Link MCU direct mode
LDEDID	Write EDID data to input
LDFW	Load new firmware
LOAD	Load new Transwitch firmware
MODEL?	Read device model
NAME	Set machine (DNS) name
NAME-RST	Reset machine name to factory default (DNS)
PRIO?	Get input priority
PRIORITY	Set priority for all channels
PROT-VER?	Get device protocol version
RESET	Reset device
SECUR	Set current security state
SIGNAL	Valid / Invalid input
SN?	Read device serial number
VERSION?	Read device firmware version
VID	Switch video only

Command - #		Command Type - System-mandatory	
Command Name		Permission	Transparency
Set:	#	End User	Public
Get:	-	-	-
Description		Syntax	
Set:	Protocol handshaking	# <input type="text"/>	
Get:	-	-	
Response			
~ <input type="text"/> @ <input type="text"/> SPOK _{CR LF}			
Parameters			
Response Triggers			
Notes			
Use to validate the Protocol 3000 connection and get the machine number			

Command - AV		Command Type - Switch	
Command Name		Permission	Transparency
Set:	AV	End User	Public
Get:	-	-	-
Description		Syntax	
Set:	Switch audio and video	#AV <input type="text"/> in>out, in>out,... _{CR}	
Get:			
Response			
~ <input type="text"/> @AV <input type="text"/> in>out, in>out,... _{CR LF}			
Parameters			
<i>in</i> - input number or '0' to disconnect output > - connection character between in and out parameters <i>out</i> - output number or '*' for all outputs			
Response Triggers			
Notes			

Command - AV-SW-MODE		Command Type - System	
Command Name		Permission	Transparency
Set:	AV-SW-MODE	End user	Public
Get:	AV-SW-MODE?	End user	Public
Description		Syntax	
Set:	Set input auto switch mode (per output)	# AV-SW-MODE _[SP] <i>layer,output_id, mode</i> _[CR]	
Get:	Get input auto switch mode (per output)	# AV-SW-MODE? _[SP] <i>layer,output_id</i> _[CR]	
Response			
~ _[nn] @ AV-SW-MODE _[SP] <i>layer,output_id, mode</i> _[CR LF]			
Parameters			
<i>layer</i>			
<i>output_id</i> - 1....num of system outputs			
<i>mode</i> - 0 - manual			
1 - priority switch			
2 - last connected switch			
Response Triggers			
Notes			

Command - AV-SW-TIMEOUT		Command Type - System	
Command Name		Permission	Transparency
Set:	AV-SW-TIMEOUT	End User	Public
Get:	AV-SW-TIMEOUT?	End User	Public
Description		Syntax	
Set:	Set auto switching timeout	# AV-SW-TIMEOUT _[SP] <i>action,time_out</i> _[CR]	
Get:	Get auto switching timeout	# AV-SW-TIMEOUT? _[SP] <i>action</i> _[CR]	
Response			
~ _[nn] @ AV-SW-TIMEOUT _[SP] <i>action,time_out</i> _[CR]			
Parameters			
<i>action</i> 0 - on video signal loss timeout			
1 - on new video signal detected switch timeout			
<i>time_out</i> - timeout in seconds			
Response Triggers			
Notes			

Command - BUILD-DATE		Command Type - System-mandatory	
Command Name		Permission	Transparency
Set:	-	-	-
Get:	BUILD-DATE?	End User	Public
Description		Syntax	
Set:	Get device build date	# BUILD-DATE _{CR}	
Get:	-	-	
Response			
~ nn @ BUILD-DATE _{SP} <i>date</i> _{SP} <i>time</i> _{CR LF}			
Parameters			
<i>date</i> - Format: YYYY/MM/DD where YYYY = Year, MM = Month, DD = Day			
<i>time</i> - Format: hh:mm:ss where hh = hours, mm = minutes, ss = seconds			
Response Triggers			
Notes			

Command - CPEDID		Command Type - System	
Command Name		Permission	Transparency
Set:	CPEDID	End User	Public
Get:	-	-	-
Description		Syntax	
Set:	Copy EDID data from the output to the input EEPROM	# CPEDID _{SP} <i>src_type, src_id, dst_type, dest_bitmap</i> _{CR}	
Get:	-	-	
Response			
~ nn @ CPEDID _{SP} <i>src_stg, src_id, dst_type, dest_bitmap</i> _{CR LF}			
Parameters			
<i>src_type</i> - EDID source type (usually output) (see Section 11.2.1 EDID Source)			
<i>src_id</i> - number of chosen source stage (1.. max number of inputs/outputs)			
<i>dst_type</i> - EDID destination type (usually input) (see Section 5.12 EDID Source)			
<i>dest_bitmap</i> - bitmap representing destination IDs. Format: XXXX...X, where X is hex digit. The binary form of every hex digit represents corresponding destinations. Setting '1' says that EDID data has to be copied to this destination			
Response Triggers			
Response is sent to the com port from which the Set was received (before execution)			
Notes			
Destination bitmap size depends on device properties (for 64 inputs it is a 64-bit word) Example: bitmap 0x0013 means inputs 1,2 and 5 are loaded with the new EDID			

Command - DIR		Command Type - File System	
Command Name		Permission	Transparency
Set:	DIR	Administrator	Public
Get:	-	-	-
Description		Syntax	
Set:	List files in device	# DIR <code>[CR]</code>	
Get:	-	-	
Response			
Multi Line: ~ <code>[nr]</code> @ DIR <code>[CR LF]</code> <code>file_name [TAB] file_size[SP]bytes.[SP] ID:[SP]file_id[CR LF]</code> <code>[TAB]free_size[SP]bytes.[CR LF]</code>			
Parameters			
<code>file_name</code> - name of file <code>file_size</code> - file size in bytes. A file can take more space on device memory <code>file_id</code> - internal ID for file in file system <code>free_size</code> - free space in bytes in device file system			
Response Triggers			
Notes			

Command - DISPLAY?		Command Type - System	
Command Name		Permission	Transparency
Set:	-	-	-
Get	DISPLAY?	End User	Public
Description		Syntax	
Set:	-	-	
Get:	Get output HPD status	# DISPLAY? <code>[SP]out_id[CR]</code>	
Response			
~ <code>[nr]</code> @ DISPLAY <code>[SP]out_id,status [CR LF]</code>			
Parameters			
<code>out_id</code> - output number <code>status</code> - HPD status according to signal validation			
Response Triggers			
After execution, response is sent to the com port from which the Get was received Response is sent after every change in output HPD status ON to OFF Response is sent after every change in output HPD status OFF to ON and ALL parameters (new EDID, etc.) are stable and valid			
Notes			

Command - FACTORY		Command Type - System-mandatory	
Command Name		Permission	Transparency
Set:	FACTORY	End User	Public
Get:	-	-	-
Description		Syntax	
Set:	Reset device to factory default configuration	# FACTORY <input type="checkbox"/>	
Get:	-	-	
Response			
~ <input type="checkbox"/> <input type="checkbox"/> @ FACTORY <input type="checkbox"/> SP OK <input type="checkbox"/> CR LF			
Parameters			
Response Triggers			
Notes			
This command deletes all user data from the device. The deletion can take some time.			

Command - FS-FREE?		Command Type - File System	
Command Name		Permission	Transparency
Set:	-	-	-
Get:	FS-FREE?	Administrator	Public
Description		Syntax	
Set:	-	-	
Get:	Get file system free space	# FS-FREE? <input type="checkbox"/>	
Response			
~ <input type="checkbox"/> <input type="checkbox"/> @ FS_FREE <input type="checkbox"/> SP <i>free_size</i> <input type="checkbox"/> CR LF			
Parameters			
<i>free_size</i> - free size in device file system in bytes			
Response Triggers			
Notes			

Command - GEDID		Command Type - System	
Command Name		Permission	Transparency
Set:	GEDID	Administrator	Public
Get:	GEDID?	End User	Public
Description		Syntax	
Set:	Set EDID data from device	#GEDID _[SP] stage, stage_id _[CR]	
Get:	Get EDID support on certain input/output	#GEDID? _[SP] stage, stage_id _[CR]	
Response			
Set:			
Multi-line response:			
~nn@GEDID _[SP] stage,stage_id,size _[CR LF]			
EDID_data _[CR LF]			
~nn@GEDID _[SP] stage,stage_id _[SP] OK _[CR LF]			
Get:			
~nn@GEDID _[SP] stage,stage_id,size _[CR LF]			
Parameters			
stage - input/output (see Section 11.2.1 EDID Source)			
stage_id - number of chosen stage (1.. max number of inputs/outputs)			
size - EDID data size. For Set, size of data to be sent from device, for Get, 0 means no EDID support			
Response Triggers			
Response is sent to the com port from which the Set (before execution) / Get command was received			
Notes			
For Get, size=0 means EDID is not supported			
For old devices that do not support this command, ~nn@ ERR 002 _[CR LF] is received			

Command - HDCP-MOD		Command Type - System	
Command Name		Permission	Transparency
Set:	HDCP-MOD	Administrator	Public
Get:	HDCP-MOD?	End User	Public
Description		Syntax	
Set:	Set HDCP mode	# HDCP-MOD _{SP} <i>inp_id,mode</i> _{CR}	
Get:	Get HDCP mode	# HDCP-MOD? _{SP} <i>stage_id</i> _{CR}	
Response			
Set / Get: ~ <i>nn</i> @ HDCP-MOD _{SP} <i>stage_id,mode</i> _{CR LF}			
Parameters			
<i>inp_id</i> - input number (1.. max number of inputs) <i>mode</i> - HDCP mode			
Response Triggers			
Response is sent to the com port from which the Set (before execution) / Get command was received Response is sent to all com ports after execution if HDCP-MOD was set by any other external control device (button press, device menu and similar) or HDCP mode changed			
Notes			
Set HDCP working mode on the device input: HDCP supported - HDCP_ON [default] HDCP not supported - HDCP OFF HDCP support changes following detected sink - MIRROR OUTPUT			

Command - HDCP-STAT		Command Type - System	
Command Name		Permission	Transparency
Set:	-	-	-
Get:	HDCP-STAT?	End User	Public
Description		Syntax	
Set:	None	-	
Get:	Get HDCP signal status	# HDCP-STAT? <input type="checkbox"/> <i>stage</i> , <i>stage_id</i> <input type="checkbox"/>	
Response			
Set / Get: ~ <input type="checkbox"/> @ HDCP-STAT <input type="checkbox"/> <i>stage</i> , <i>stage_id</i> , <i>mode</i> <input type="checkbox"/> <input type="checkbox"/>			
Parameters			
<i>stage</i> – input/output			
<i>stage_id</i> - number of chosen stage (1.. max number of inputs/outputs)			
<i>actual_status</i> - signal encryption status - valid values ON/OFF			
Response Triggers			
Response is sent to the com port from which the Set (before execution) / Get command was received			
Response is sent to all com ports after execution if HDCP-STAT was set by any other external control device (button press, device menu and similar) or HDCP mode changed			
Notes			

Command - HELP		Command Type - System-mandatory	
Command Name		Permission	Transparency
Set:	-	-	-
Get:	HELP	End User	Public
Description		Syntax	
Set:	-	-	
Get:	Get command list or help for specific command	2 options: 1. # HELP <input type="checkbox"/> 2. # HELP <input type="checkbox"/> <i>command_name</i> <input type="checkbox"/>	
Response			
1. Multi-line: ~ <input type="checkbox"/> @ Device available protocol 3000 commands: <input type="checkbox"/> <i>command</i> <input type="checkbox"/> <i>command</i> ... <input type="checkbox"/> <input type="checkbox"/>			
To get help for command use: HELP (COMMAND_NAME) <input type="checkbox"/> <input type="checkbox"/>			
2. Multi-line: ~ <input type="checkbox"/> @ HELP <input type="checkbox"/> <i>command</i> : <input type="checkbox"/> <i>description</i> <input type="checkbox"/> <input type="checkbox"/> USAGE: <i>usage</i> <input type="checkbox"/> <input type="checkbox"/>			
Parameters			
Response Triggers			
Notes			

Command – KLINK_INF		Command Type – System	
Command Name		Permission	Transparency
Set:	KLINK_INF	Admin	Internal
Get:	-	-	-
Description		Syntax	
Set:	Set K-Link MCU direct mode (DGKat only)	# KLINK_INF _{CR}	
Get :	-	-	
Response			
KLNK_ACK _{CR LF}			
Parameters			
None			
Response Triggers			
After receiving KLINK_INF command over DGKat/local RS-232			
Notes			

Command – KLINK_CLS		Command Type – System	
Command Name		Permission	Transparency
Set:	KLINK_CLS	Admin	Internal
Get:	-	-	-
Description		Syntax	
Set:	Set K-Link data mode (DGKat only)	# KLINK_CLS _{CR}	
Get:	-	-	
Response			
KLNK_ACK _{CR LF}			
Parameters			
None			
Response Triggers			
Under receiving KLINK_CLS command over DGKat/RS-232			
Notes			

Command - LDEDID		Command Type - System	
Command Name		Permission	Transparency
Set:	LDEDID	End User	Public
Get:	-	-	-
Description		Syntax	
Set:	Write EDID data from external application to device	Multi-step syntax (see following steps)	
Get:	None	None	
Communication Steps (Command and Response)			
Step 1: # LDEDID _{SP} <i>dst_type, dest_bitmask, size, safe_mode</i> _{CR} Response 1: ~ nn @ LDEDID _{SP} <i>dst_type, dest_bitmask, size, safe_mode</i> _{SP} READY _{CR LF} or ~ nn @ LDEDID _{SP} ERRnn _{CR LF}			
Step 2: If ready was received, send EDID_DATA Response 2: ~ nn @ LDEDID _{SP} <i>dst_type, dest_bitmask, size, safe_mode</i> _{SP} OK _{CR LF} or ~ nn @ LDEDID _{SP} ERRnn _{CR LF}			
Parameters			
<i>dst_type</i> - EDID destination type (usually input) (see Section 11.2.1 EDID Source) <i>dest_bitmask</i> - bitmap representing destination IDs. Format: 0x*****, where * is ASCII presentation of hex digit. The binary presentation of this number is a bit mask for destinations. Setting '1' means EDID data has to be copied to this destination <i>size</i> - EDID data size <i>safe_mode</i> - 0 - Device accepts the EDID as is without trying to adjust 1 - Device tries to adjust the EDID EDID_DATA - data in protocol packets			
Response Triggers			
Response is sent to the com port from which the Set (before execution)			
Notes			
When the unit receives the LDEDID command it replies with READY and enters the special EDID packet wait mode. In this mode the unit can receive only packets and not regular protocol commands. If the unit does not receive correct packets for 30 seconds or is interrupted for more than 30 seconds before receiving all packets, it sends timeout error ~ nn @ LDEDID _{SP} ERR01 _{CR LF} and returns to the regular protocol mode. If the unit received data that is not a correct packet, it sends the corresponding error and returns to the regular protocol mode.			

Command - LDFW		System - Packets	
Command Name		Permission	Transparency
Set:	LDFW	Internal SW	Public
Get:	-	-	-
Description		Syntax	
Set:	Load new firmware file	Step 1: # LDFW _{SP} size _{CR} Step 2: If ready was received, send FIRMWARE_DATA	
Get:	-	-	
Response			
Response 1: ~ nn @ LDFW _{SP} size _{SP} READY _{CR LF} or ~ nn @ LDFW _{SP} ERRnn _{CR LF}			
Response 2: ~ nn @ LDFW _{SP} size _{SP} OK _{CR LF}			
Parameters			
<i>size</i> - size of firmware data that is sent			
FIRMWARE_DATA - HEX or KFW file in protocol packets (see Section 4)			
Response Triggers			
Notes			
In most devices firmware data is saved to flash memory, but the memory does not update until receiving the "UPGRADE" command and is restarted. Use this command in dedicated SW application			

Command - LOAD		Command Type - System - Packets	
Command Name		Permission	Transparency
Set:	LOAD	Administrator	Public
Get:	-	-	-
Description		Syntax	
Set:	Load file to device	# LOAD _{SP} <i>file_name</i> , <i>size</i> _{CR}	
Get:	-	-	
Response			
Data sending negotiation:			
* Device -			
~ 01 @ LOAD _{SP} <i>file_name</i> , <i>size</i> _{SP} READY _{CR LF}			
* End User (+Device)-			
Send file in Protocol Packets			
* Device -			
~ 01 @ LOAD _{SP} <i>file_name</i> , <i>size</i> _{SP} OK _{CR LF}			
Parameters			
<i>file_name</i> - name of file to save on device			
<i>size</i> - size of file data that is sent.			
Response Triggers			
Notes			

Command - MODEL?		Command Type - System-mandatory	
Command Name		Permission	Transparency
Set:	-	-	-
Get:	MODEL?	End User	Public
Description		Syntax	
Set:	-	-	
Get:	Get device model	# MODEL? _{CR}	
Response			
~ hn @ MODEL _{SP} <i>model_name</i> _{CR LF}			
Parameters			
<i>model_name</i> - String of up to 19 printable ASCII chars			
Response Triggers			
Notes			

Command - NAME		Command Type - System (Ethernet)	
Command Name		Permission	Transparency
Set:	NAME	Administrator	Public
Get:	NAME?	End User	Public
Description		Syntax	
Set:	Set machine (DNS) name	# NAME _{SP} machine_name _{CR}	
Get:	Get machine (DNS) name	# NAME? _{CR}	
Response			
Set: ~ nn @ NAME _{SP} machine_name _{SP} OK _{CR LF}			
Get: ~ nn @ NAME? _{SP} machine_name _{CR LF}			
Parameters			
machine_name - String of up to 14 alpha-numeric chars (can include hyphen, not at the beginning or end)			
Response Triggers			
Notes			
The machine name is not the same as the model name. The machine name is used to identify a specific machine or a network in use (with DNS feature on)			

Command - NAME-RST		Command Type - System (Ethernet)	
Command Name		Permission	Transparency
Set:	NAME-RST	Administrator	Public
Get:	-	-	-
Description		Syntax	
Set:	Reset machine (DNS) name to factory default	# NAME-RST _{CR}	
Get:	-	-	
Response			
~ nn @ NAME-RST _{SP} OK _{CR LF}			
Parameters			
Response Triggers			
Notes			
Factory default of machine (DNS) name is "KRAMER_" + 4 last digits of device serial number			

Command - PRIO		Command Type - System	
Command Name		Permission	Transparency
Set:	PRIO	Administrator	Public
Get	PRIO?	Administrator	Public
Description		Syntax	
Set:	Set input priority	# PRIO _{SP} input_id,prio _{CR}	
Get:	Get input priority	# PRIO? _{SP} input_id _{CR}	
Response			
~nn@ PRIO _{SP} input_id,prio _{CR LF}			
Parameters			
<i>input_id</i> - window number setting new source <i>prio</i> - assigned priority (1.. max priority)			
Response Triggers			
After execution, response is sent to the com port from which the Set/Get was received After execution, response is sent to all com ports if PRIO was set by any other external control device (button press, device menu and similar)			
Notes			
The PRIO max value may vary for different devices			

Command - PRIORITY		Command Type - System	
Command Name		Permission	Transparency
Set:	PRIORITY	Administrator	Public
Get:	PRIORITY?	Administrator	Public
Description		Syntax	
Set:	Set input priority	# PRIORITY _{SP} layer,PRIORITY1, PRIORITY2... PRIORITYn _{CR}	
Get:	Get input priority	# PRIORITY? _{SP} layer _{CR}	
Response			
~nn@ PRIORITY _{SP} layer,PRIORITY1, PRIORITY2... PRIORITYn _{CR LF}			
Parameters			
<i>layer</i> <i>PRIORITY1</i> - priority of first input <i>PRIORITYn</i> - priority of input n			
Response Triggers			
Notes			
WP-577VH – layer parameter is not used			

Command - PROT-VER?		Command Type - System-mandatory	
Command Name		Permission	Transparency
Set:	-	-	-
Get:	PROT-VER?	End User	Public
Description		Syntax	
Set:	-	-	
Get:	Get device protocol version	# PROT-VER? <input type="checkbox"/> <small>CR</small>	
Response			
~ <input type="checkbox"/> @ PROT-VER <input type="checkbox"/> <small>SP</small> 3000:version <input type="checkbox"/> <small>CR LF</small>			
Parameters			
Version - XX.XX where X is a decimal digit			
Response Triggers			
Notes			

Command - RESET		Command Type - System-mandatory	
Command Name		Permission	Transparency
Set:	RESET	Administrator	Public
Get:	-	-	-
Description		Syntax	
Set:	Reset device	# RESET <input type="checkbox"/> <small>CR</small>	
Get:	-	-	
Response			
~ <input type="checkbox"/> @ RESET <input type="checkbox"/> <small>SP</small> OK <input type="checkbox"/> <small>CR LF</small>			
Parameters			
Response Triggers			
Notes			
To avoid locking the port due to a USB bug in Windows, disconnect USB connections immediately after running this command. If the port was locked, disconnect and reconnect the cable to reopen the port.			

Command - SECUR		Command Type - Authentication	
Command Name		Permission	Transparency
Set:	SECUR	Administrator	Public
Get:	SECUR?	Not Secure	Public
Description		Syntax	
Set:	Start/stop security	# SECUR _{SP} security_mode _{CR}	
Get:	Get current security state	# SECUR? _{CR}	
Response			
Set:	~ _{nr} @ SECUR _{SP} security_mode _{SP} OK _{CR LF}		
Get:	~ _{nr} @ SECUR _{SP} security_mode _{CR LF}		
Parameters			
security_mode – 1/ON - enables security, 0/OFF - disables security			
Response Triggers			
Notes			
The permission system works only if security is enabled with the “SECUR” command			

Command - SIGNAL		Command Type - System	
Command Name		Permission	Transparency
Set:	-	-	-
Get	SIGNAL?	End User	Public
Description		Syntax	
Set:	-	-	
Get:	Get input signal lock status	# SIGNAL? _{SP} inp_id _{CR}	
Response			
~ _{nr} @ SIGNAL _{SP} inp_id,status _{CR LF}			
Parameters			
inp_id - input number			
status - lock status according to signal validation			
Response Triggers			
After execution, a response is sent to the com port from which the Get was received			
Response is sent after every change in input signal status ON to OFF, or OFF to ON			
Notes			

Command - SN?		Command Type - System-mandatory	
Command Name		Permission	Transparency
Set:	-	-	-
Get:	SN?	End User	Public
Description		Syntax	
Set:	-	-	
Get:	Get device serial number	# SN? _{CR}	
Response			
- _{nn} @ SN _{SP} serial_number _{CR LF}			
Parameters			
serial_number - 11 decimal digits, factory assigned			
Response Triggers			
Notes			
For new products with 14 digit serial numbers, use only the last 11 digits			

Command - VERSION?		Command Type - System-mandatory	
Command Name		Permission	Transparency
Set:	-	-	-
Get:	VERSION?	End User	Public
Description		Syntax	
Set:	-	-	
Get:	Get firmware version number	# VERSION? _{CR}	
Response			
- _{nn} @ VERSION _{SP} firmware_version _{CR LF}			
Parameters			
firmware_version - XX.XX.XXXX where the digit groups are: major.minor.build version			
Response Triggers			
Notes			

Command - VID		Command Type - Switch	
Command Name		Permission	Transparency
Set:	VID	End User	Public
Get:	VID?	End User	Public
Description		Syntax	
Set:	Set video switch state	#VID [SP] in>out, in>out... [CR]	
Get:	Get video switch state	#VID? [SP] out [CR] #VID? [SP] * [CR]	
Response			
Set:	~nn@VID [SP] in>out [CR LF] ~nn@VID [SP] in>out [CR LF] ...		
Get:	~nn@VID [SP] in>out [CR LF] ~nn@VID [SP] in>1, in>2, ... [CR LF]		
Parameters			
in - input number or '0' to disconnect output > - connection character between in and out parameters out - output number or '*' for all outputs			
Response Triggers			
Notes			
When AFV switching mode is active, this command also switches audio and the unit replies with command ~AV.			
Examples			
When AFV switching mode is active, this command also switches audio and the unit replies with command ~AV.			
Switch video and audio input 3 to output 7	#AV 3>7 [CR]	~01@AV 3>7 [CRLF]	
Switch video input 2 to output 4	#V 2>4 [CR]	~01@VID 2>4 [CRLF]	
Switch video input 4 to output 2 in machine 6	#6@VID 4>2 [CR]	~06@VID 4>2 [CRLF]	
Disconnect video and audio output 4	#AV 0>4 [CR]	~01@AV 0>4 [CRLF]	
Switch video input 3 to all outputs	#V 3>* [CR]	~01@VID 3>* [CRLF]	

Chaining multiple commands	<p>#AV 1>* V 3>4, 2>2, 2>1, 0>2 V 3>9 A 0>1 V? * CR</p> <ol style="list-style-type: none"> 1. Switch audio and video from input 1 to all outputs 2. Switch video input 3 to output 4, video input 2 to output 2, video input 2 to output 1 and disconnect video output 2 3. Switch video input 3 to output 9 (non-existent) 4. Disconnect audio output 1 5. Get status of all video links <p>Command processing begins after entering CR A response is sent for each command after processing</p>	<p>~AV 1>*CRLF ~VID 3>4CRLF ~VID 2>2CRLF ~VID 2>1CRLF ~VID 0>2CRLF</p> <p>~VID ERR003 CRLF ~AUD 0>1CRLF ~VID 2>1, 0>2, 1>3, 3>4CRLF</p>
----------------------------	---	--

11.2.1 EDID Source

Number	Value
0	Input
1	Output
2	Default EDID

11.2.2 Signal Validation

Number	Value
0	Signal or sink is not valid
1	Signal or sink is valid
2	Sink and EDID is valid

LIMITED WARRANTY

The warranty obligations of Kramer Electronics for this product are limited to the terms set forth below:

What is Covered

This limited warranty covers defects in materials and workmanship in this product.

What is Not Covered

This limited warranty does not cover any damage, deterioration or malfunction resulting from any alteration, modification, improper or unreasonable use or maintenance, misuse, abuse, accident, neglect, exposure to excess moisture, fire, improper packing and shipping (such claims must be presented to the carrier), lightning, power surges, or other acts of nature. This limited warranty does not cover any damage, deterioration or malfunction resulting from the installation or removal of this product from any installation, any unauthorized tampering with this product, any repairs attempted by anyone unauthorized by Kramer Electronics to make such repairs, or any other cause which does not relate directly to a defect in materials and/or workmanship of this product. This limited warranty does not cover cartons, equipment enclosures, cables or accessories used in conjunction with this product.

Without limiting any other exclusion herein, Kramer Electronics does not warrant that the product covered hereby, including, without limitation, the technology and/or integrated circuit(s) included in the product, will not become obsolete or that such items are or will remain compatible with any other product or technology with which the product may be used.

How Long Does this Coverage Last

Seven years as of this printing; please check our Web site for the most current and accurate warranty information.

Who is Covered

Only the original purchaser of this product is covered under this limited warranty. This limited warranty is not transferable to subsequent purchasers or owners of this product.

What Kramer Electronics will do

Kramer Electronics will, at its sole option, provide one of the following three remedies to whatever extent it shall deem necessary to satisfy a proper claim under this limited warranty:

1. Elect to repair or facilitate the repair of any defective parts within a reasonable period of time, free of any charge for the necessary parts and labor to complete the repair and restore this product to its proper operating condition. Kramer Electronics will also pay the shipping costs necessary to return this product once the repair is complete.
2. Replace this product with a direct replacement or with a similar product deemed by Kramer Electronics to perform substantially the same function as the original product.
3. Issue a refund of the original purchase price less depreciation to be determined based on the age of the product at the time remedy is sought under this limited warranty.

What Kramer Electronics will not do Under This Limited Warranty

If this product is returned to Kramer Electronics or the authorized dealer from which it was purchased or any other party authorized to repair Kramer Electronics products, this product must be insured during shipment, with the insurance and shipping charges prepaid by you. If this product is returned uninsured, you assume all risks of loss or damage during shipment. Kramer Electronics will not be responsible for any costs related to the removal or re-installation of this product from or into any installation. Kramer Electronics will not be responsible for any costs related to any setting up this product, any adjustment of user controls or any programming required for a specific installation of this product.

How to Obtain a Remedy under this Limited Warranty

To obtain a remedy under this limited warranty, you must contact either the authorized Kramer Electronics reseller from whom you purchased this product or the Kramer Electronics office nearest you. For a list of authorized Kramer Electronics resellers and/or Kramer Electronics authorized service providers, please visit our web site at www.kramerelectronics.com or contact the Kramer Electronics office nearest you.

In order to pursue any remedy under this limited warranty, you must possess an original, dated receipt as proof of purchase from an authorized Kramer Electronics reseller. If this product is returned under this limited warranty, a return authorization number, obtained from Kramer Electronics, will be required. You may also be directed to an authorized reseller or a person authorized by Kramer Electronics to repair the product.

If it is decided that this product should be returned directly to Kramer Electronics, this product should be properly packed, preferably in the original carton, for shipping. Cartons not bearing a return authorization number will be refused.

Limitation on Liability

THE MAXIMUM LIABILITY OF KRAMER ELECTRONICS UNDER THIS LIMITED WARRANTY SHALL NOT EXCEED THE ACTUAL PURCHASE PRICE PAID FOR THE PRODUCT. TO THE MAXIMUM EXTENT PERMITTED BY LAW, KRAMER ELECTRONICS IS NOT RESPONSIBLE FOR DIRECT, SPECIAL, INCIDENTAL OR CONSEQUENTIAL DAMAGES RESULTING FROM ANY BREACH OF WARRANTY OR CONDITION, OR UNDER ANY OTHER LEGAL THEORY. Some countries, districts or states do not allow the exclusion or limitation of relief, special, incidental, consequential or indirect damages, or the limitation of liability to specified amounts, so the above limitations or exclusions may not apply to you.

Exclusive Remedy

TO THE MAXIMUM EXTENT PERMITTED BY LAW, THIS LIMITED WARRANTY AND THE REMEDIES SET FORTH ABOVE ARE EXCLUSIVE AND IN LIEU OF ALL OTHER WARRANTIES, REMEDIES AND CONDITIONS, WHETHER ORAL OR WRITTEN, EXPRESS OR IMPLIED. TO THE MAXIMUM EXTENT PERMITTED BY LAW, KRAMER ELECTRONICS SPECIFICALLY DISCLAIMS ANY AND ALL IMPLIED WARRANTIES, INCLUDING, WITHOUT LIMITATION, WARRANTIES OF MERCHANTABILITY AND FITNESS FOR A PARTICULAR PURPOSE. IF KRAMER ELECTRONICS CANNOT LAWFULLY DISCLAIM OR EXCLUDE IMPLIED WARRANTIES UNDER APPLICABLE LAW, THEN ALL IMPLIED WARRANTIES COVERING THIS PRODUCT, INCLUDING WARRANTIES OF MERCHANTABILITY AND FITNESS FOR A PARTICULAR PURPOSE, SHALL APPLY TO THIS PRODUCT AS PROVIDED UNDER APPLICABLE LAW.

IF ANY PRODUCT TO WHICH THIS LIMITED WARRANTY APPLIES IS A "CONSUMER PRODUCT" UNDER THE MAGNUSON-MOSS WARRANTY ACT (15 U.S.C.A. §2301, ET SEQ.) OR OTHER APPLICABLE LAW, THE FOREGOING DISCLAIMER OF IMPLIED WARRANTIES SHALL NOT APPLY TO YOU, AND ALL IMPLIED WARRANTIES ON THIS PRODUCT, INCLUDING WARRANTIES OF MERCHANTABILITY AND FITNESS FOR THE PARTICULAR PURPOSE, SHALL APPLY AS PROVIDED UNDER APPLICABLE LAW.

Other Conditions

This limited warranty gives you specific legal rights, and you may have other rights which vary from country to country or state to state.

This limited warranty is void if (i) the label bearing the serial number of this product has been removed or defaced, (ii) the product is not distributed by Kramer Electronics or (iii) this product is not purchased from an authorized Kramer Electronics reseller. If you are unsure whether a reseller is an authorized Kramer Electronics reseller, please visit our Web site at www.kramerelectronics.com or contact a Kramer Electronics office from the list at the end of this document.

Your rights under this limited warranty are not diminished if you do not complete and return the product registration form or complete and submit the online product registration form. Kramer Electronics thanks you for purchasing a Kramer Electronics product. We hope it will give you years of satisfaction.



For the latest information on our products and a list of Kramer distributors, visit our Web site where updates to this user manual may be found.

We welcome your questions, comments, and feedback.

Web site: www.kramerelectronics.com

E-mail: info@kramerel.com

CE



SAFETY WARNING

Disconnect the unit from the power supply before opening and servicing



P/N: 2900-300311



Rev: 2