

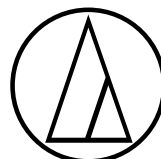


# 600 Series Professional UHF Wireless Systems

---

- ATW-601** UniPak™ System
- ATW-601G** Guitar System
- ATW-601H** Headworn Microphone System
- ATW-601L** Lavalier Microphone System
- ATW-602** Handheld Microphone System

## *Installation and Operation*



**audio-technica®**

# Professional UHF Wireless Systems

## Installation and Operation

This device complies with part 15 of the FCC Rules. Operation is subject to the condition that this device does not cause harmful interference.

This device complies with INDUSTRY CANADA R.S.S. 210, en conformité avec IC: RSS-210/CNR210. Operation is subject to the following conditions: 1) This device may not cause harmful interference and 2) this device must accept any interference received, including interference which may cause undesired operation.

**CAUTION!** Electrical shock can result from removal of the receiver cover. Refer servicing to qualified service personnel. No user-serviceable parts inside. Do not expose to rain or moisture.

The circuits inside the receiver and transmitter have been precisely adjusted for optimum performance and compliance with federal regulations. Do not attempt to open the receiver or transmitter. To do so will void the warranty, and may cause improper operation.

**Individuals with implanted cardiac pacemakers or AICD devices:** Please see notice on back cover.

### Introduction

Thank you for choosing an Audio-Technica professional wireless system. You have joined thousands of other satisfied customers who have chosen our products because of their quality, performance and reliability. This wireless microphone system is the successful result of years of design and manufacturing experience.

Each Freeway™ 600 Series professional UHF wireless system includes a receiver and either a body-pack transmitter or a handheld microphone/transmitter. ATW-601 UniPak body-pack transmitter systems include models pre-packaged with either an AT-GCW guitar cable (/G), a PRO 8HEcW headworn microphone (/H) or an AT829cW lavalier mic (/L) for particular applications. All A-T Wireless Essentials™ microphones and cables, available separately, are pre-terminated for use with any ATW-601 system.

Because Freeway packaging is designed to hold all versions of the system, some compartments in the carton are intentionally left empty.

All units operate on ten switch-selected frequencies in one of two UHF frequency ranges: Band "A" units in 470-480 MHz, and Band "B" units in 482-492 MHz:

	<b>Band "A"</b> <b>470-480 MHz</b> <b>(TV Ch. 14-15)</b>	<b>Band "B"</b> <b>482-492 MHz</b> <b>(TV Ch. 16-17)</b>
<b>UniPak™ System</b>	ATW-601A	ATW-601B
<b>Guitar System</b>	ATW-601A/G	ATW-601B/G
<b>Headworn Mic System</b>	ATW-601A/H	ATW-601B/H
<b>Lavalier Mic System</b>	ATW-601A/L	ATW-601B/L
<b>Handheld Mic System</b>	ATW-602A	ATW-602B

The ATW-R600 receiver design features a novel "docking" power supply configuration. An AC power adapter housed in a compartment in the receiver uses an IEC-standard detachable power cordset. Furthering its flexibility, the power adapter may be easily removed from the receiver case, permitting its use as a conventional in-line AC adapter.

The versatile ATW-T601 UniPak™ body-pack transmitter has both a high-impedance input for instruments, and a low-impedance input with bias connection for use with dynamic and electret condenser microphones. The ATW-T602 handheld transmitter features a unidirectional dynamic microphone element.

Both the body-pack and handheld transmitters use internal 9-volt batteries and have Off/Standby/On switches, input Trim (level) adjustments and battery condition indicators.

Note: 600 Series "A" Band transmitters must be used only with "A" Band receivers; the same holds true for 600 Series "B" Band transmitters and receivers. For multiple-mic applications, as many as four systems in the "A" Band may be used together, and/or up to four systems in the "B" Band. This permits multi-channel combinations with up to eight channels using only 600 Series systems.

Please note that in a multi-channel application, there must be a transmitter-receiver combination on a separate frequency for each input desired (only one transmitter for each receiver). Because the 600 Series operates on UHF TV frequencies (channels 14-15 or 16-17), only certain wireless frequencies may be useable in a particular geographic area. (Frequency selection information will be found on page 6.)

## Receiver Installation

### Location

For best operation the receiver should be at least 3' (1 m) above the ground and at least 3' (1 m) away from a wall or metal surface to minimize reflections. Keep the receiver antennas away from noise sources such as digital equipment, motors, automobiles and neon lights, as well as away from large metal objects. In multi-channel systems, position receivers at least 3' (1 m) apart and keep operating transmitters at least 6' (2 m) from the receivers to help assure maximum RF performance.

### Output Connection

The receiver provides unbalanced, aux-level output from a 1/4" TS ("mono") phone jack; an output cable is not included. Use a shielded audio cable with 1/4" phone plug to connect the receiver's AF Out jack to the mixer/amplifier's aux-level input.

### Power Connection

Turn the receiver's volume control all the way down. If not already connected, plug the small DC output cord from the AC power adapter to the DC power input jack on the back of receiver. Plug the power cordset into the power adapter, and then connect the cordset to an AC source.

(Note that the receiver has no power Off/On switch. The receiver will be energized whenever the power adapter is connected and plugged into the AC outlet. Unplug the cordset from the AC outlet whenever the system is not in use – both for safety, and to conserve energy.)

If desired, the power adapter may be removed from the receiver housing and used as an in-line supply. To remove the adapter, *gently* pull the release tab *slightly* away from the housing; then pull the power supply *straight back* out of the receiver (Fig. A). Extend the 12V DC cord and/or the AC cordset as desired.

### Antennas

A novel "dipole" antenna system on the receiver improves operation by providing a "ground" element in addition to the usual "signal" element. Position the two antennas at 90° in the form of a "V," or position the left ("signal") antenna vertically and the right ("ground") antenna horizontally, in the shape of an "L" (Fig. B). Use the position that performs better in your operating environment. Be certain to extend both antennas to their full 6 1/4" (158 mm) length by pulling out on their caps. Both antenna elements may be swiveled to the left and right, but do not attempt to rotate them in a screwing/unscrewing motion. To do so may damage the antenna and/or receiver. For best performance, locate the receiver so its antennas are in direct line-of-sight to the transmitter's likely operating position.

## Receiver Controls and Functions

### Front Panel Controls and Functions (Fig. C)

1. ANTENNAS: Position the "signal" antenna (1a) and "ground" antenna (1b) as shown in Figure B. Fully extend both antennas by pulling up on their end-caps.
2. CHANNEL SELECTOR: Chooses receiver operating frequency. (Transmitter must be set to the same channel.)
3. POWER INDICATOR: Lights when power is supplied to the receiver.
4. RF INDICATOR: Lights to show presence of transmitter signal.
5. AF PEAK INDICATOR: Indicates when maximum transmitter modulation without distortion has been reached. Not affected by position of Volume control.
6. VOLUME CONTROL: Adjusts the audio level at the 1/4" output jack. Does not affect AF Peak indicator.

### Rear Panel Controls and Functions (Fig. D)

7. AC POWER ADAPTER: Power supply "docks" inside receiver housing, but can be removed to be used as an in-line supply if desired.
8. RELEASE TAB: Pull down *slightly* to permit removal of power adapter from receiver housing.
9. AC INPUT: Connect the AC cordset here.
10. DC POWER CORD: Connects the power supply's 12-volt DC output to the receiver's DC input jack.
11. DC POWER INPUT: Connect the provided docking power adapter, or other 12V DC source. (Receiver requires 200 mA.)
12. SQUELCH CONTROL: Adjusts level of noise-muting circuit (preset at factory but can be adjusted as circumstances warrant).
13. AUDIO OUTPUT JACK: 1/4" TS (Tip-Sleeve) or "mono" phone jack. Use a shielded cable to connect to an unbalanced aux-level input of a mixer or amplifier.

## Transmitter Setup

### Battery Selection and Installation

An alkaline 9-volt battery is recommended. ***Make certain the transmitter power switch is Off before installing or changing batteries.***

When inserting the battery, ***observe correct polarity as marked inside the battery compartment.*** The transmitter housings are designed to prevent incorrect installation of the battery; ***do not force the battery in.*** Reversed batteries may cause damage to the transmitter.

### UniPak™ Transmitter Battery Installation

1. Slide off the battery cover as shown in Figure E.
2. Carefully insert a fresh 9V alkaline battery, observing polarity markings.
3. Replace the battery cover (Fig. F).

### Handheld Transmitter Battery Installation

1. While holding the upper part of the transmitter body just below the ball-screen, unscrew the lower body cover and slide it downward to expose the battery compartment.
2. Lift the white "battery keeper" arm until it sticks straight out from the mic body (no higher). Then carefully insert a fresh 9V alkaline battery, observing polarity markings (Fig. G).
3. Replace the lower body cover. ***Do not overtighten.***

### Battery Condition Indicator

When the transmitter is turned on with a fresh battery installed, the red LED battery condition indicator (Fig. I/J) will flash strongly once, then reduce to a continuous dim glow. As the battery weakens, the LED's glow will increase. When the LED's glow becomes substantially brighter, there is little life left in the battery. (When the battery is mostly exhausted, the LED will cease to light.) As soon as the LED noticeably brightens, replace the battery promptly for continued operation of the transmitter.

### UniPak™ Transmitter Input Connection

Connect an audio input device (microphone or guitar cable) to the input connector on the bottom of the transmitter.

A number of Audio-Technica professional microphones and cables are available separately, pre-terminated with a UniPak input connector (see "Optional System Accessories" on page 7).

### Transmitting Antenna

The UniPak transmitter includes a permanently-attached flexible antenna. For best results, allow the antenna to hang freely and full length from the bottom of the transmitter. If the received signal is marginal, experiment with different transmitter positions on your body or instrument; or try repositioning the receiver. Do not attempt to remove, replace or change the length of the transmitting antenna.

### Mounting Clip

The mounting clip on the UniPak transmitter may be attached so it is positioned either "up" or "down" in relation to the case, depending upon which is preferred for the application. To change the clip direction, simply (1) spread the ends of the clip until it comes free of the holes in the sides of the case; (2) position the clip with the desired orientation; (3) spread the clip slightly again so it clears the sides of the case; and (4) make certain the clip ends are fully seated in the mounting holes in the case. Best performance usually results when the antenna is hanging freely at full length.

## System Operation

Turn down the receiver volume control and the mixer/amplifier level before starting up the wireless system. Do *not* switch on the transmitter yet.

### Receiver on...

Plug the power cordset into an AC power source. The red Power indicator on the front panel will light. Using the rotary switch (CH) on the front panel, select channel "0" through "9." Refer to page 6 to help choose an appropriate operating frequency for your area.

### Transmitter on...

*Before* turning on the transmitter, use the provided screwdriver to set its channel switch *to the same channel selected on the receiver*.

When the transmitter is switched on, the receiver's yellow RF signal indicator will light. The transmitters have a 3-position power switch. When the switch is set to "Standby" (ST), the transmitter produces RF with no audio signal. When the switch is "On," the transmitter produces both RF and audio. Maximum audio input to the transmitter will cause the receiver's red AF Peak indicator to light.

*When setting or changing the transmitter frequency, always turn the transmitter power off first, set the frequency, then turn the transmitter back on.*

### Receiver Squelch

The squelch control on the rear panel of the receiver is preset at the factory, but can be adjusted if you must use the system in a high RF interference area. If there is audio output from the receiver when your transmitter is off, adjust the squelch control so the system will receive the signal from your transmitter but "squelch" or eliminate the unwanted background RF noise. This adjustment can cause a reduction in useable range of the wireless transmitter, so set the control to the lowest position which reliably mutes the unwanted RF signals.

### Input Level Adjustment

An input trimmer control (Trim) in the transmitters enables you to maximize performance for a particular microphone or guitar sensitivity, or to adjust for different acoustic input levels.

### Adjusting Input Level - UniPak Transmitter

Slide the battery cover off the top part of transmitter and remove the screwdriver from its clip (Fig. E). Gently turn the Trim control to its full counterclockwise position (marked "L").

### • Microphone: Adjusting input level

While speaking/singing into the microphone at typically-loud levels, carefully turn the Trim control clockwise while watching the receiver's AF Peak indicator. Increase the Trim control setting until the AF Peak indicator lights. This indicates that maximum transmitter modulation without significant distortion has been reached.

### • Guitar/Instrument: Adjusting input level

While playing at typically-loud levels, carefully turn the Trim control clockwise while watching the receiver's AF Peak indicator. Increase the Trim control setting until the AF Peak indicator lights. This indicates that maximum transmitter modulation without significant distortion has been reached.

After adjusting input level, return the screwdriver to its clip and reinstall the battery cover. No further transmitter gain adjustments should be needed, as long as the input device and the acoustic input level are not changed.

### Adjusting Input Level - Handheld Transmitter

Unscrew the lower body cover and slide it downward, exposing the screwdriver and Trim control (Fig. G/H). Remove the screwdriver and gently turn the Trim control to its full counterclockwise position (marked "L").

While speaking/singing into the microphone at typically-loud levels, carefully turn the Trim control clockwise while watching the receiver's AF Peak indicator. Increase the control setting until the AF Peak indicator lights. This indicates that maximum transmitter modulation without significant distortion has been reached.

Return the screwdriver to its clip and close and secure the lower body. No further transmitter gain adjustments should be needed, as long as the acoustic input does not change significantly.

**CAUTION!** *The small trimmer controls are delicate; use only the supplied screwdriver. Do not force the trimmers beyond their normal 190° range of rotation.*

*Return the screwdriver to its storage clip when not in use.*

## Ten Tips To Obtain The Best Results

1. Use only fresh alkaline batteries. Do not use "general purpose" (carbon-zinc) batteries.
2. Position the receiver so that it has the fewest possible obstructions between it and the normal location of the transmitter. Line-of-sight is best.
3. The transmitter and the receiver must be set to the same frequency. Set or change transmitter frequency only when its power is turned **off**.
4. The transmitter and the receiver should be as close together as conveniently possible, but not less than 6' (2 m).
5. Do not place the receiver antennas within 3' (1 m) of another receiver or antenna.
6. The receiver antennas should be kept away from any metal.
7. A receiver cannot receive signals from two transmitters at the same time.
8. If the volume control of the receiver is set too high, it may over-drive the input of the mixer/amplifier, causing distortion. Conversely, if the receiver output is set too low, the overall signal-to-noise ratio of the system may be reduced. Adjust the output level of the receiver so the highest sound pressure level going into the microphone (or the loudest instrument playing level) causes no input overload in the mixer, and yet permits the mixer level controls to operate in their "normal" range (not set too high or too low). This provides the optimum signal-to-noise for the entire system.
9. Turn the transmitter off when not in use. Remove the battery if the transmitter is not to be used for a period of time.
10. Unplug the receiver from the AC outlet when the system is not in use.

## System Operating Frequencies

### Frequency Selection

Each transmitter/receiver system operates on a choice of ten switch-selected frequencies. Available frequencies are shown in the chart below.

Note that the 600 Series receiver and transmitters operate either in TV channels 14-15, identified as Band "A" units, or in channels 16-17, identified as Band "B" units. 600 Series "A" Band transmitters must be used only with "A" Band receivers; the same holds true for 600 Series "B" Band transmitters and receivers. The Band marking will be found on the receiver's front panel ("Freq. Band A" or "Freq. Band B"), on the nameplate of the ATW-T601 body-pack transmitter ("T601A" or "T601B"), and as part of the model number on the color naming of the ATW-T602 handheld transmitter ("T602A" or "T602B").

(The letters "A" and "B" as used here are for identification only within the 600 Series. They have no relationship to any use of the letters "A" and "B" as a designation on other products.)

Because these frequencies are shared with TV broadcasting, frequency selection is largely dependent upon which TV broadcast channels are in operation *where the wireless system is to be used*.

### RF Interference

If you encounter receiving interference (from other than an operating TV station), often it can be eliminated by adjusting the receiver's squelch control, as described on page 5. In multi-channel systems, position receivers at least 3' (1 m) apart and keep operating transmitters at least 6' (2 m) from the receivers to help assure maximum RF performance.

Please note that wireless frequencies are shared with other radio services. According to Federal Communications Commission regulations, "Wireless microphone operations are unprotected from interference from other licensed operations within the band. If any interference is received by any Government or non-Government operation, the wireless microphone must cease operation..."

If you need assistance with operation or frequency selection, please contact your dealer or the A-T professional division.

Extensive wireless information also is available on the A-T Web site at [www.audio-technica.com](http://www.audio-technica.com).

**ATW-600A Systems**

Channel	Frequency - MHz	TV Channel
0	470.000	TV14
1	471.250	TV14
2	472.300	TV14
3	473.500	TV14
4	474.750	TV14
5	476.200	TV15
6	476.950	TV15
7	477.750	TV15
8	479.000	TV15
9	479.750	TV15

ATW-600A frequency selection for multi-channel systems:

Channels 1, 4, 7, 9

For use where TV Channel 14 is operating:

Channels 7, 9

For use where TV Channel 15 is operating:

Channels 1, 4

All multi-channel selections above may be combined in "A" and "B" bands for up to eight simultaneous operating channels.

To help assure maximum performance in multi-channel systems, position receivers at least 3' (1 m) apart, and keep operating transmitters at least 6' (2 m) from the receivers.

**ATW-600B Systems**

Channel	Frequency - MHz	TV Channel
0	482.000	TV16
1	483.250	TV16
2	484.750	TV16
3	485.500	TV16
4	487.500	TV16
5	488.100	TV17
6	489.150	TV17
7	489.750	TV17
8	491.000	TV17
9	491.750	TV17

ATW-600B frequency selection for multi-channel systems:

Channels 1, 3, 7, 9

For use where TV Channel 16 is operating:

Channels 7, 9

For use where TV Channel 17 is operating:

Channels 1, 3

For future reference, please record your system information here (the serial numbers appear on the bottom of receiver, inside the battery compartment of the ATW-T601 transmitter and next to the screwdriver clip inside the ATW-T602 transmitter).

**Receiver**

Model ATW-R600 \_\_\_\_\_ Serial Number \_\_\_\_\_  
A/B

**Transmitter**

Model ATW-T60 \_\_\_\_\_ Serial Number \_\_\_\_\_  
1/2      A/B

## Specifications†

### OVERALL SYSTEM

UHF Operating Frequency	
Band A	470.000 MHz to 479.750 MHz
Band B	482.000 MHz to 491.750 MHz
Number of Channels	10
Frequency Stability	±0.005%, Phase Lock Loop frequency control
Modulation Mode	FM
Maximum Deviation	±15 kHz
Operating Range	150' minimum
Operating Temperature Range	40° F (4° C) to 110° F (43° C)
Frequency Response	
ATW-601	50 Hz to 16 kHz
ATW-602	100 Hz to 13 kHz

### RECEIVER

Receiving System	Non-diversity, 10-channel, synthesized dual antenna system
Image Rejection	50 dB minimum
Signal-to-noise Ratio	80 dB at 10 kHz deviation (IEC-weighted), maximum modulation 15 kHz
Total Harmonic Distortion	≤1% (10 kHz deviation at 1 kHz)
Sensitivity	25 µV for 60 dB S/N (IEC-weighted)
Audio Output	350 mV (1 kHz modulation, 10 kHz deviation, 100k ohm load)
Output Connector	1/4" TS ("mono") phone jack
Power Supply	120V AC 60 Hz, 6 VA; or 12V DC, 200 mA, center positive, with external DC supply
Dimensions	8.27" (210.0 mm) W x 1.72" (43.5 mm) H x 4.73" (120.0 mm) D
Net Weight	18.9 oz (536 grams); without AC adapter, 11.9 oz (336 grams)
Accessories Included	AD1202A 120V docking AC adapter; 120V AC IEC cordset

### UNIPAK™ TRANSMITTER

RF Power Output	10 mW nominal, 5 mW typical
Spurious Emissions	Under federal regulations
Dynamic Range	≥90 dB, A-weighted
Input Connections	High impedance, low impedance, bias
Battery	9V (NEDA type 1604) alkaline, not included
Current Consumption	60 mA typical
Battery Life	4-5 hours
Dimensions	2.56" (65.0 mm) W x 4.41" (112.0 mm) H x 0.87" (22.0 mm) D
Net Weight (without battery)	3.2 oz (89 grams)

### HANDHELD TRANSMITTER

RF Power Output	10 mW nominal, 5 mW typical
Spurious Emissions	Under federal regulations
Dynamic Range	≥90 dB, A-weighted
Microphone Element	Dynamic unidirectional
Battery	9V (NEDA type 1604) alkaline, not included
Current Consumption	60 mA typical
Battery Life	4-5 hours
Dimensions	9.65" (245.0 mm) long, 2.11" (53.5 mm) diameter
Net Weight (without battery)	11.2 oz (316 grams)
Accessory Included	AT8456a stand clamp

† In the interest of standards development, A.T.U.S. offers full details on its test methods to other industry professionals on request.

## Optional System Accessories

### WIRELESS ESSENTIALS™ MICROPHONES AND CABLES

All Wireless Essentials accessories are terminated for use with ATW-T601 and other UniPak™ transmitters.

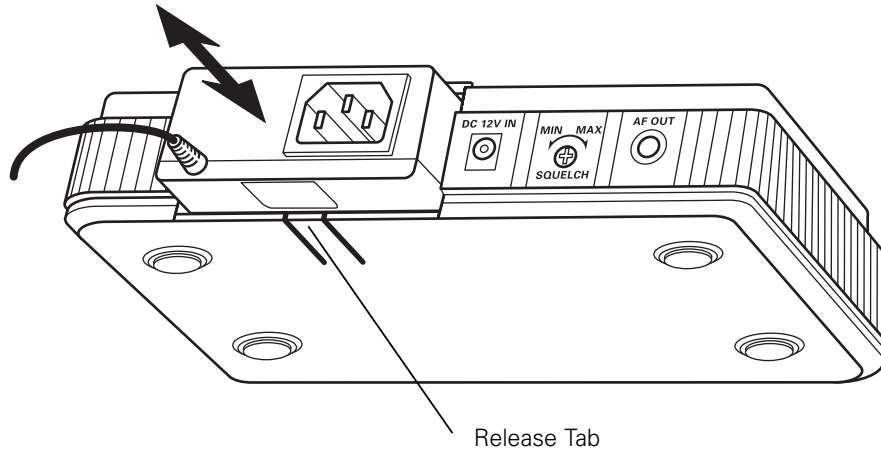
AT829cW	Miniature cardioid condenser lavalier microphone. Includes clothing clip and windscreen. Provided with ATW-601/L systems.
MT830cW	Subminiature omnidirectional condenser lavalier microphone. Includes clothing clip and windscreen.
MT830cW-TH	"Theater" model, same as MT830cW except beige color mic and cable for concealment.
AT831cW	Miniature cardioid condenser lavalier microphone. Includes clothing clip and windscreen.
AT851cW	Surface-mount wide-range hemi-cardioid condenser microphone.
AT857AMLcW	19" gooseneck cardioid microphone. Mounts to 5/8"-27 thread. Includes windscreen.
AT889cW	Headworn noise-canceling condenser microphone. Includes windscreen and cable clip.
ATM35cW	Cardioid condenser instrument microphone. Includes AT8418 clip-on instrument mount.
ATM73cW	Headworn cardioid condenser microphone. Includes windscreen.
ATM75cW	Headworn cardioid condenser microphone. Includes windscreen.
PRO 8HEcW	Headworn hypercardioid dynamic microphone. Includes windscreen and cable clip. Provided with ATW-601/H systems.
PRO 35xcW	Cardioid condenser instrument microphone. Includes AT8418 clip-on instrument mount.

AT-GCW	Hi-Z instrument/guitar cable with 1/4" phone plug. Provided with ATW-601/G systems.
XLRW	Connecting cable for UniPak transmitter with an XLRF-type input connector, for Lo-Z microphones with XLRM-type output terminations.

### OTHER ACCESSORIES

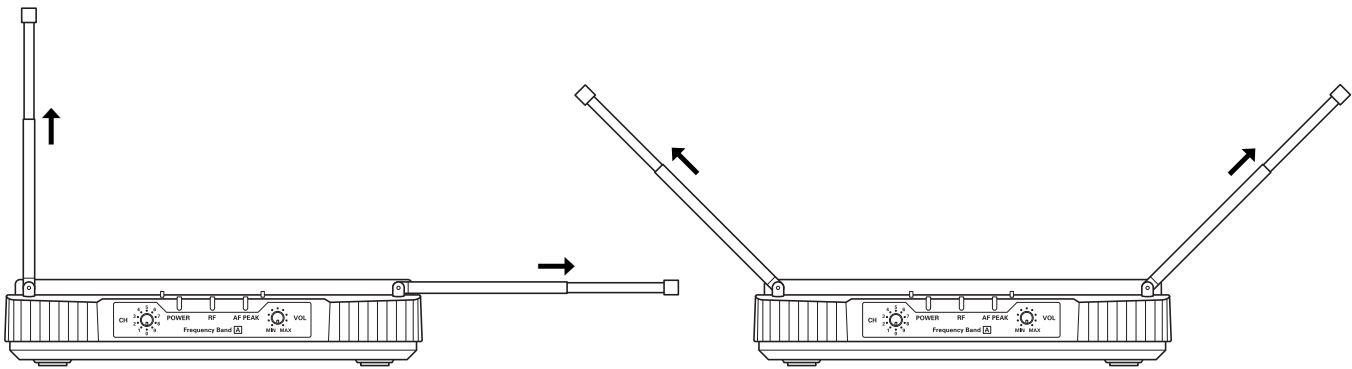
AT8114	Foam windscreen for handheld transmitter.
AT8141	Water-resistant pouch for UniPak transmitter.
AT8390	Shielded audio cable with 1/4" to 1/4" phone plugs. Available in a variety of lengths. (Also available with one straight and one 90° phone plug as the AT8316.)
AT8431	Stand clamp for handheld transmitter, 5/8"-27 threads.
AT8456a	Stand clamp for handheld transmitter, 5/8"-27 threads.
ATW-VP10	Vinyl pouch with belt clip to hold UniPak transmitter.

## Receiver Power Supply



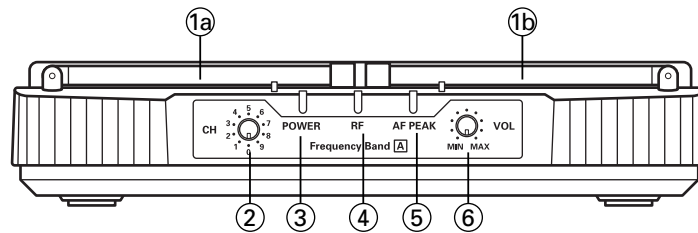
**Figure A** (p. 3)

## Antennas

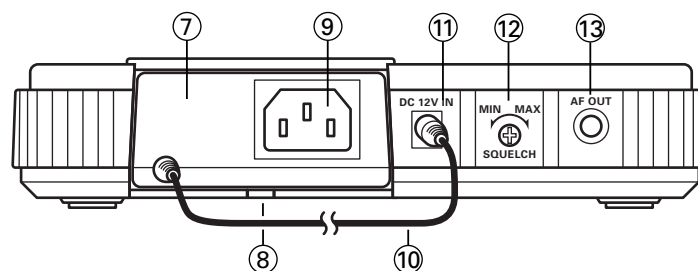


**Figure B** (p. 3)

## Receiver Controls and Functions

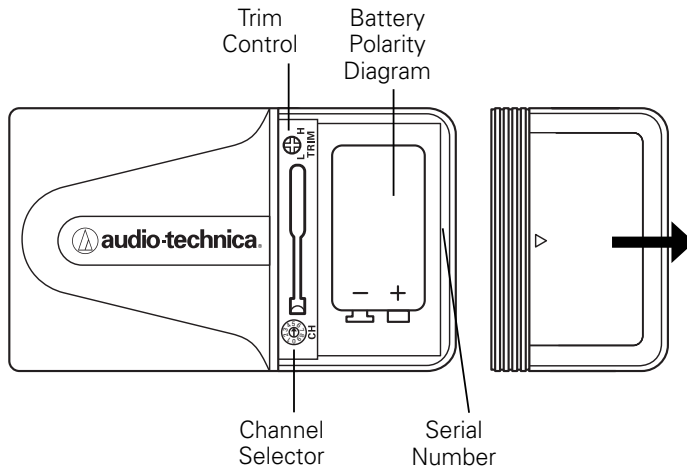


**Figure C** (p. 3)

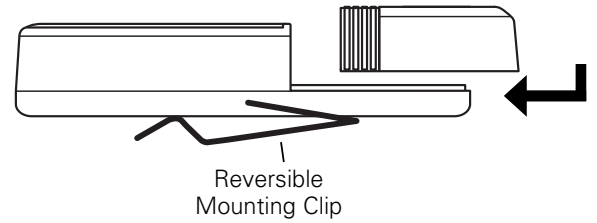


**Figure D** (p. 3)

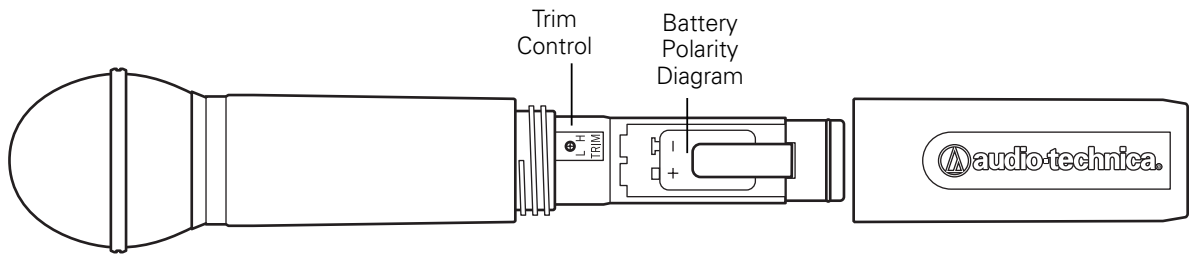
**Transmitter Controls and Functions**



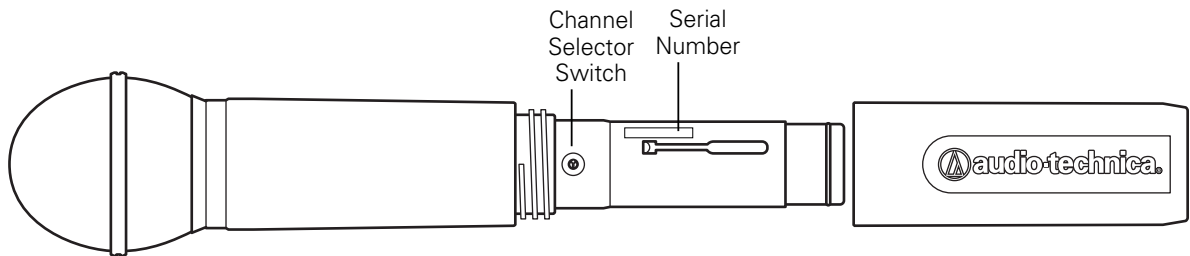
**Figure E** (p. 4)



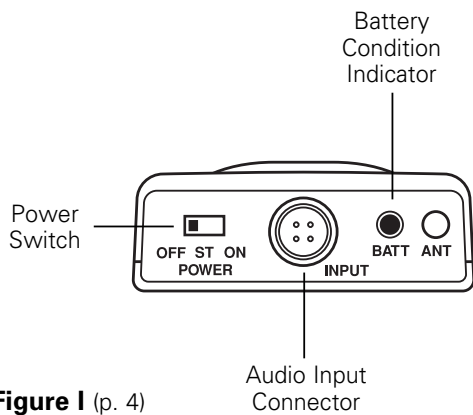
**Figure F** (p. 4)



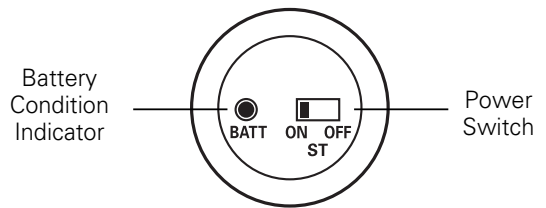
**Figure G** (p. 4)



**Figure H** (p. 5)



**Figure I** (p. 4)



**Figure J** (p. 4)

### One-Year Limited Warranty

Audio-Technica professional wireless systems purchased in the U.S.A. are warranted for one year from date of purchase by Audio-Technica U.S., Inc. (A.T.U.S.) to be free of defects in materials and workmanship. In event of such defect, product will be repaired promptly without charge or, at our option, replaced with a new product of equal or superior value if delivered to A.T.U.S. or an Authorized Service Center, prepaid, together with the sales slip or other proof of purchase date. **Prior approval from A.T.U.S. is required for return.** This warranty excludes defects due to normal wear, abuse, shipping damage, or failure to use product in accordance with the instructions. This warranty is void in the event of unauthorized repair or modification, or removal or defacing of the product labeling.

**For return approval and shipping information,** contact the Service Dept., Audio-Technica U.S., Inc., 1221 Commerce Drive, Stow, Ohio 44224.

Except to the extent precluded by applicable state law, **A.T.U.S. will have no liability for any consequential, incidental, or special damages; any warranty of merchantability or fitness for particular purpose expires when this warranty expires.**

This warranty gives you specific legal rights, and you may have other rights which vary from state to state.

Outside the U.S.A., please contact your local dealer for warranty details.

### Notice to individuals *with implanted cardiac pacemakers or AICD devices:*

Any source of RF (radio frequency) energy *may* interfere with normal functioning of the implanted device. All wireless microphones have low-power transmitters (less than 0.05 watts output) which are unlikely to cause difficulty, especially if they are at least a few inches away. However, since a "body-pack" mic transmitter typically is placed against the body, we suggest attaching it at the belt, rather than in a shirt pocket where it may be immediately adjacent to the medical device. Note also that *any medical-device disruption will cease when the RF transmitting source is turned off.* Please contact your physician or medical-device provider if you have any questions, or experience any problems with the use of this or any other RF equipment.

***Visit our Web Site!***  
***www.audio-technica.com***

