

RSX PASSIVE LOUDSPEAKERS

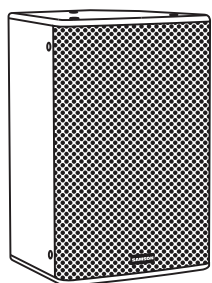

RSX110

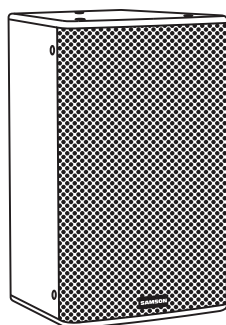

RSX112

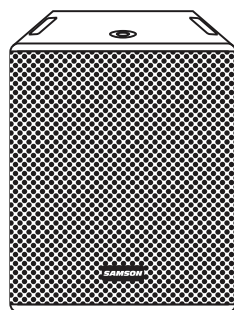

RSX118S

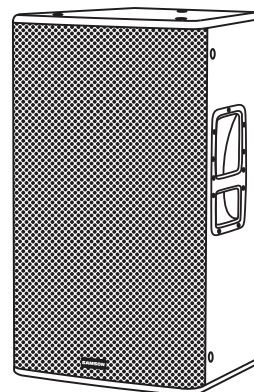

RSX115

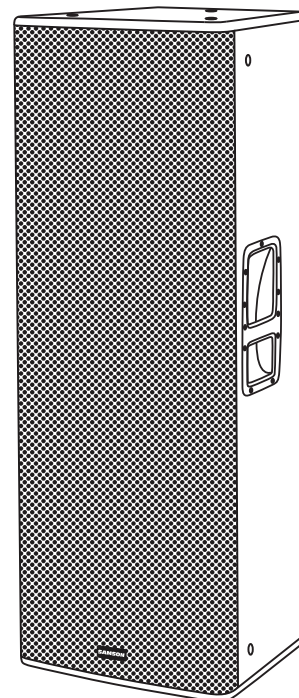

RSX215

OWNER'S MANUAL

SAMSON[®]

Copyright 2013, Samson Technologies Corp.

v2.2

Samson Technologies Corp.

45 Gilpin Avenue

Hauppauge, New York 11788-8816

Phone: 1-800-3-SAMSON (1-800-372-6766)

Fax: 631-784-2201

www.samsontech.com

Speakon® is a registered trademark of Neutrik AG

Safety Instructions



WARNING: To reduce the risk of fire or electric shock, do not expose this unit to rain or moisture. To reduce the hazard of electrical shock, do not remove cover or back. No user serviceable parts inside. Please refer all servicing to qualified personnel. The lightning flash with an arrow-head symbol within an equilateral triangle, is intended to alert the user to the presence of uninsulated "dangerous voltage" within the products enclosure that may be of sufficient magnitude to constitute a risk of electric shock to persons. The exclamation point within an equilateral triangle is intended to alert the user to the presence of important operating and maintenance (servicing) instructions in the literature accompanying the product.

Important Safety Instructions

1. Please read all instructions before operating the unit.
2. Keep these instructions for future reference.
3. Please heed all safety warnings.
4. Follow manufacturers instructions.
5. Do not use this unit near water or moisture.
6. Clean only with a damp cloth.
7. Do not block any of the ventilation openings. Install in accordance with the manufacturers instructions.
8. Do not install near any heat sources such as radiators, heat registers, stoves, or other apparatus (including amplifiers) that produce heat.
9. Do not defeat the safety purpose of the polarized or grounding-type plug. A polarized plug has two blades with one wider than the other. A grounding type plug has two blades and a third grounding prong. The wide blade or third prong is provided for your safety. When the provided plug does not fit your outlet, consult an electrician for replacement of the obsolete outlet.
10. Protect the power cord from being walked on and pinched particularly at plugs, convenience receptacles and at the point at which they exit from the unit.
11. Unplug this unit during lightning storms or when unused for long periods of time.
12. Refer all servicing to qualified personnel. Servicing is required when the unit has been damaged in any way, such as power supply cord or plug damage, or if liquid has been spilled or objects have fallen into the unit, the unit has been exposed to rain or moisture, does not operate normally, or has been dropped.

Table of Contents

Introduction5
Key Features6
Input Connections8
Basic Set Up.9
Using Speaker Stands	10
Floor Monitor Positioning	11
Configuring the RSX118S Subwoofer	12
Using an External Crossover.	13
Permanent Installation	14
Cable Wiring	15
Technical Specifications	16
Notes	19

Introduction

Thank you for purchasing a Samson RSX series passive loudspeaker. The RSX series are high performance loudspeakers designed for portable, front of house, and fixed installation sound reinforcement applications.

Consisting of four two-way loudspeakers, 10" RSX110, 12" RSX112, 15" RSX115, and dual 15" RSX215, as well as the RSX118S 18" subwoofer, the RSX series features models perfectly suited for whatever performance requirements you have. The speakers are designed to handle high output power while producing a smooth, precise sound. For prolonged durability and maximum protection against wear and tear, the RSX speakers feature plywood cabinet construction finished with a durable black textured paint, and black powder-coated perforated steel grille backed with black cloth. The loudspeaker is furnished with twelve M10x30 fly-points for applications that require permanent installation.

As fixed sound reinforcement or as a durable, great-sounding road PA, the RSX loudspeaker is ideal for sound professionals and performers looking for serious output and precision sound quality from a PA speaker system.

In these pages, you'll find a detailed description of the features of the RSX loudspeaker, instructions for its setup and use, and full specifications. If your loudspeaker was purchased in the United States, you'll also find a warranty card enclosed—don't forget to fill it out and mail it in so that you can receive online technical support and so that we can send you updated information about this and other Samson products, in the future. Also, be sure to check out our website (www.samsontech.com) for complete information about our full product line.

We recommend that you keep the following records for reference, as well as a copy of your sales receipt.

Serial number: _____

Date of purchase: _____

Dealer name: _____

With proper care and maintenance, your RSX loudspeaker will operate trouble-free for many years. Should your loudspeaker ever require servicing, a Return Authorization (RA) number must be obtained before shipping the loudspeaker to Samson. Without this number, the unit will not be accepted. Please call Samson at 1-800-3SAMSON (1-800-372-6766) for an RA number prior to shipping your unit. Please retain the original packing materials and, if possible, return the unit in its original carton. If your RSX series loudspeaker was purchased outside of the United States, contact your local distributor for warranty details and service information.

Key Features

The RSX series passive speakers are perfectly suited for portable and permanent sound reinforcement applications. Here are some of their main features:

RSX110 (10" Two-way passive loudspeaker system)

- 200 watts AES / 800 watts peak power handling
- 10" (254 mm) Celestion low-frequency driver with 2" (50 mm) voice coil
- 1" (25 mm) Celestion PEPT high performance compression driver
- 60° x 90° horn with 1" exit for a controlled, consistent sound
- 2 x Speakon® and ¼" phone parallel speaker jacks
- Standard speaker stand pole socket for tripod mounting
- Twelve M10 (10 mm) fly points
- 60° monitor angle
- Plywood construction with durable black textured paint finish

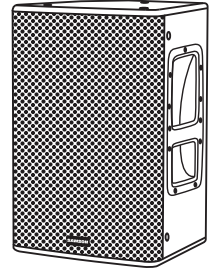

RSX112 (12" Two-way passive loudspeaker system)

- 300 watts AES / 1200 watts peak power handling
- 12" (304 mm) Celestion low-frequency driver with 2.5" (64 mm) voice coil
- 1.75" (44 mm) Celestion PEPT high performance compression driver
- 60° x 90° horn with 1" exit for a controlled, consistent sound
- 2 x Speakon® and ¼" phone parallel speaker jacks
- Standard speaker stand pole socket for tripod mounting
- Twelve M10 (10 mm) fly points
- 60° monitor angle
- Plywood construction with durable black textured paint finish

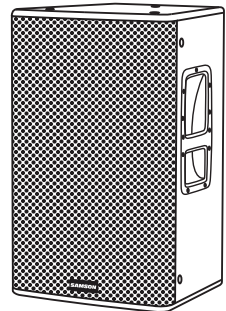

RSX115 (15" Two-way passive loudspeaker system)

- 600 watts AES / 2400 watts peak power handling
- 15" (380 mm) low-frequency driver with 3" (76 mm) voice coil
- 1.75" (44 mm) Celestion PEPT high performance compression driver
- 60° x 90° horn with 1" exit for a controlled, consistent sound
- 2 x Speakon® and ¼" phone parallel speaker jacks
- Standard speaker stand pole socket for tripod mounting
- Twelve M10 (10 mm) fly points
- Trapezoidal, plywood construction with durable black textured paint finish

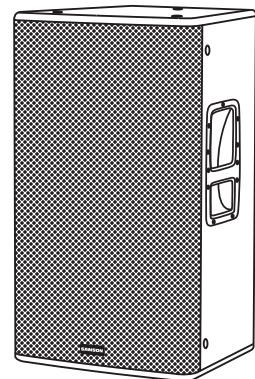

Key Features

RSX215 (Dual 15" Two-way passive loudspeaker system)

- 1200 watts AES / 4800 watts peak power handling
- Dual 15" (380 mm) low-frequency drivers with 3" (76 mm) voice coils
- 1.75" (44 mm) Celestion PEPT high performance compression driver
- 60° x 90° horn with 1" exit for a controlled, consistent sound
- 2 x Speakon® and ¼" phone parallel speaker jacks
- Twelve M10 (10 mm) fly points
- Trapezoidal, plywood construction with durable black textured paint finish

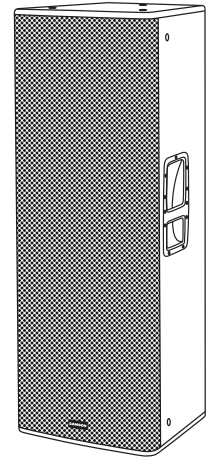

RSX118S (18" Passive Subwoofer)

- 500 watts AES / 2000 watts peak power handling
- 18" (380 mm) low-frequency woofer with 3" (76 mm) voice coil
- 2 x Speakon® parallel speaker jacks
- 96dB SPL sensitivity
- Pole-mount receptacle to stack satellite loudspeakers
- Plywood construction with durable black textured paint finish

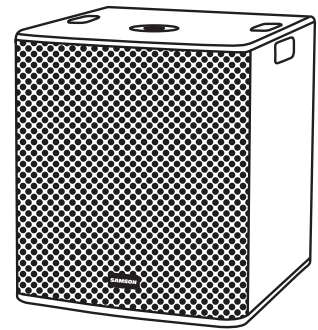

Input Connections

The RSX jack plates feature parallel speaker connectors. This enables you to directly connect an extension cabinet to an RSX speaker.

Only use one ¼" or Speakon® connector as an input connector from an amplifier. Typically, you will only connect a single extension cabinet to an RSX cabinet, but it is possible to daisy-chain multiple cabinets. When wiring multiple cabinets in parallel, attention must be paid to the overall impedance of the loudspeaker system, and the minimum load impedance of the amplifier. Please see the chart below for typical impedance calculations for multiple speaker arrangements.

Typical Impedance Calculations

$$\begin{aligned} 16\Omega + 16\Omega &= 8\Omega \\ 8\Omega + 16\Omega &= 5.3\Omega \\ 8\Omega + 8\Omega &= 4\Omega \\ 8\Omega + 16\Omega + 16\Omega &= 4\Omega \\ 16\Omega + 16\Omega + 16\Omega + 16\Omega &= 4\Omega \\ 4\Omega + 8\Omega &= 2.7\Omega \\ 4\Omega + 4\Omega &= 2\Omega \end{aligned}$$

It is recommended, especially for installation applications, to use Speakon® style connectors because they lock into jacks providing a secure connection, are able to handle high current, and the contacts do not cause a momentary short when connecting to an amplifier or speaker cabinet.

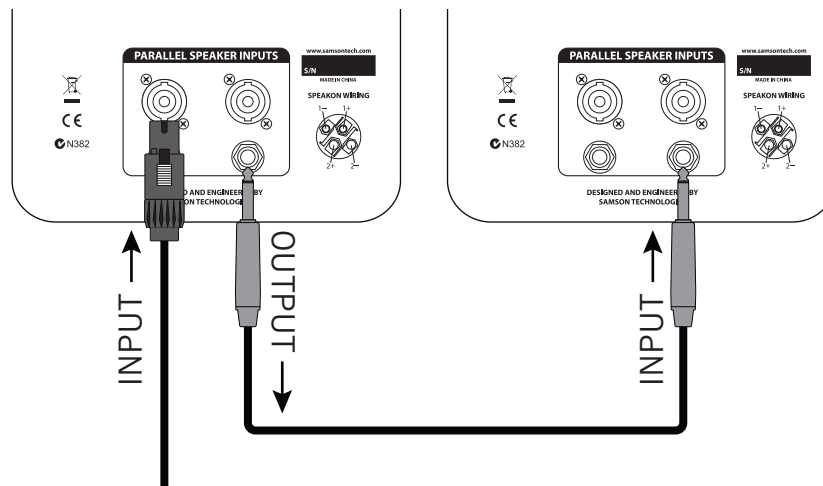

When speakers are connected in parallel, the impedance is reduced. The formula to calculate the total impedance of your speaker system is:

$$1/R_t = 1/R_1 + 1/R_2 + 1/R_3 + \dots + 1/R_n$$

where “R” is the impedance of a speaker cabinet.

If all speakers have the same impedance, the total impedance will be equal to the impedance of a single speaker divided by the total number of speakers. For example, if you have two 4 Ohm speakers connected in parallel, the total impedance is 4 divided by 2, or 2 Ohms. You must be careful when connecting speakers in parallel to an amplifier. The impedance can quickly fall below safe levels. This is especially true when connecting speakers in parallel to a bridged amplifier.

Basic Set Up

The RSX loudspeakers are passive cabinets, which means that they need to be connected to a power amplifier to reproduce an audio signal. Each speaker cabinet features parallel connectors which enable each cabinet to be daisy chained to an additional loudspeaker. When connecting multiple speakers to a power amplifier or powered mixer, you must pay attention to the minimum load impedance of the amplifier. Most amplifiers can safely provide power to loudspeakers with a minimum load impedance of 8 or 4 ohms. The RSX loudspeakers are rated at 8 ohms. This means if two RSX cabinets are wired in parallel, the nominal impedance of the speaker system will be 4 ohms.

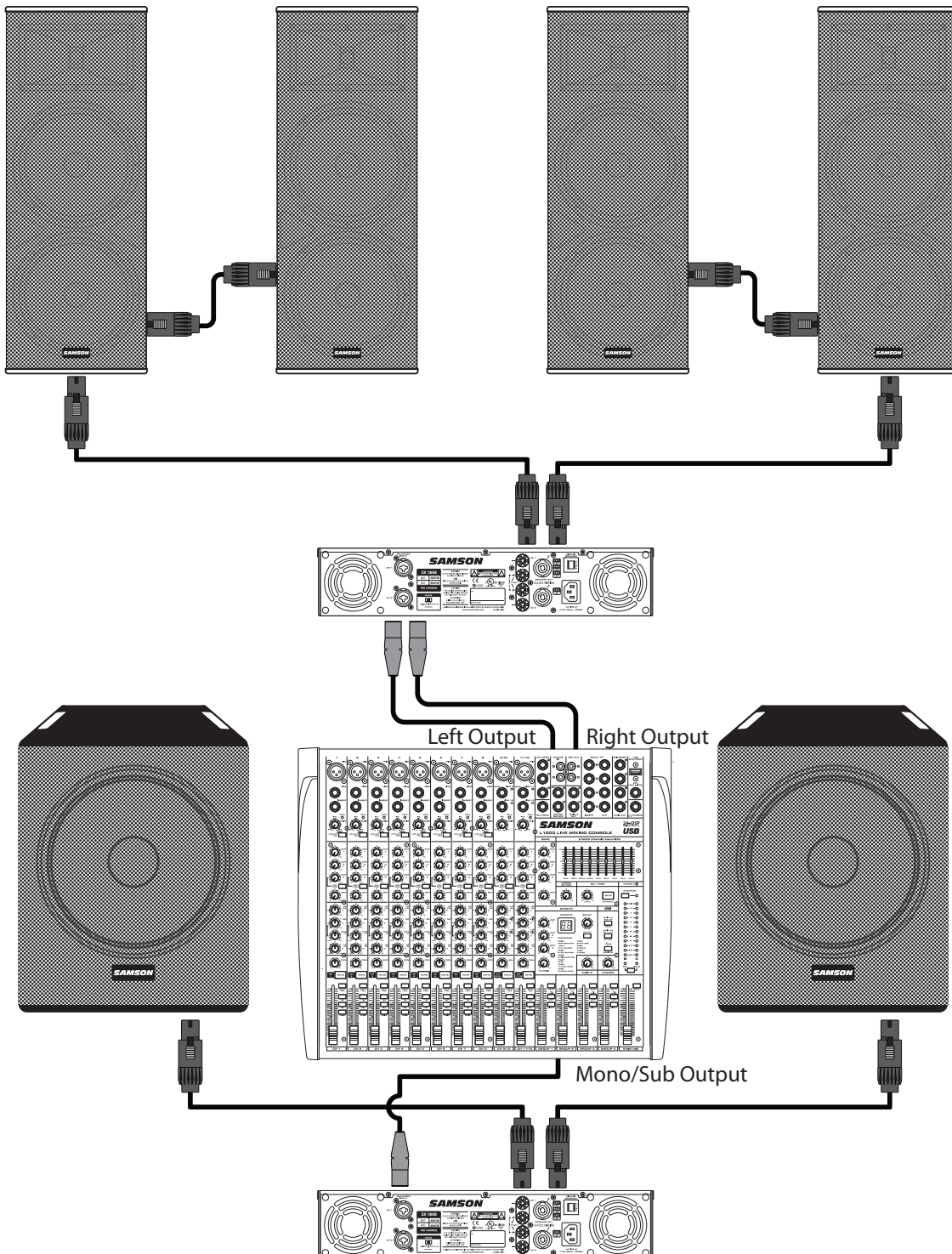

Using Speaker Stands

The RSX110, RSX112, and RSX115 feature standard 1³/₈" pole mount receptacles, which enable the speaker to be mounted on a standard tripod stand or subwoofer satellite pole. For best results, raise the speakers above the heads of the listening audience.

When mounting a speaker onto any stand, always ensure that the stand is on a flat, level surface, with the legs fully extended. Be sure to check that the maximum load weight for the stands is greater than the weight of the RSX loudspeaker. Never use a stand with a maximum load weight lower than the speaker. Do not attempt to mount more than one speaker on a stand at one time. The RSX loudspeakers are heavy. It is recommended that a second person to help place the cabinet on a stand.

When the speaker is placed on a stand, always check the integrity and center of gravity of the system. If the speaker can be tipped easily, or the pole is swaying, it is recommended that you lower the height of the stand. Position the stand and route cables so that the performers and the audience cannot tip over or trip on the system.

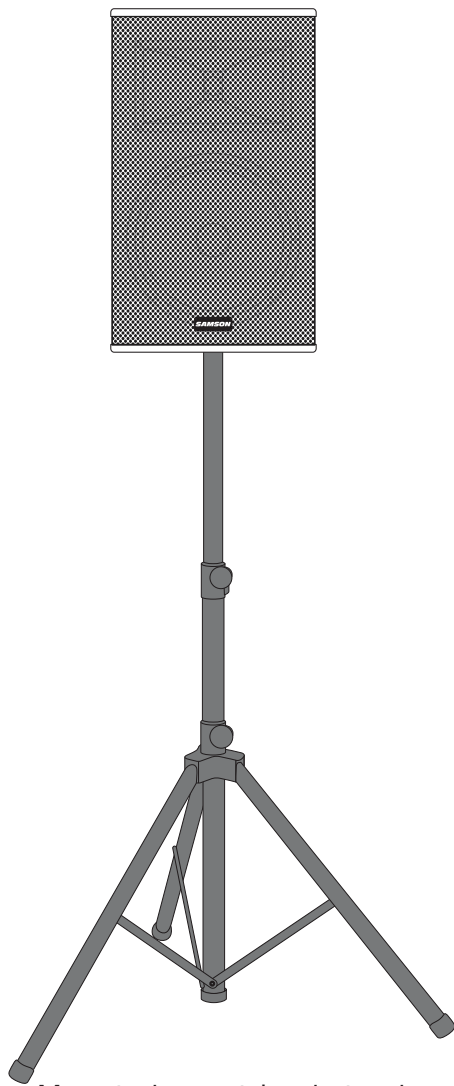

Mounted on a tripod stand

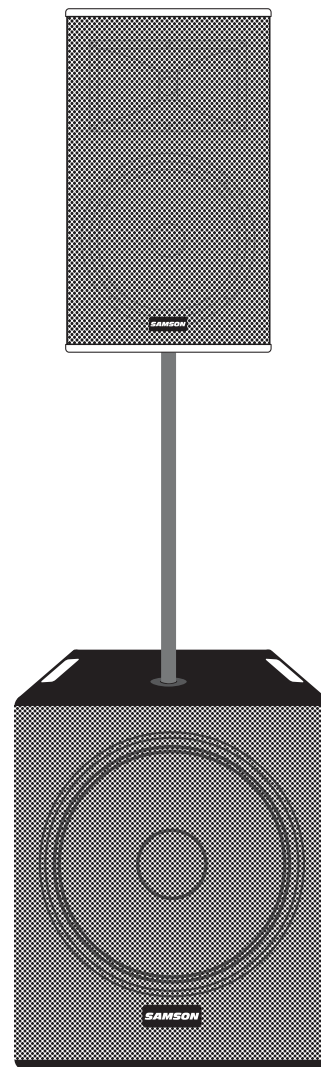

Mounted on a subwoofer satellite pole

Floor Monitor Positioning

The RSX110 and RSX112 are designed to be used as front-of-house main speakers or as floor monitors. Featuring compact design with integral 60° monitor angles, controlled bass frequency reproduction, and clear high frequency sound, the RSX speakers are ideal for stage monitoring applications or whenever a performer needs to direct sound to their ears.

In a large stage monitor system, several RSX speakers can be daisy-chained together using the parallel speaker connectors.

Note: Be sure to check the manufacturer's minimum recommended impedance for your power amplifier to avoid overload and possible damage to both the speaker and amplifier.

In many instances, when using the RSX speakers as a monitor system, you may choose to use an external equalizer like the Samson S-Curve 131 to tailor the sound to cut through the stage levels and to reduce the chance of feedback.

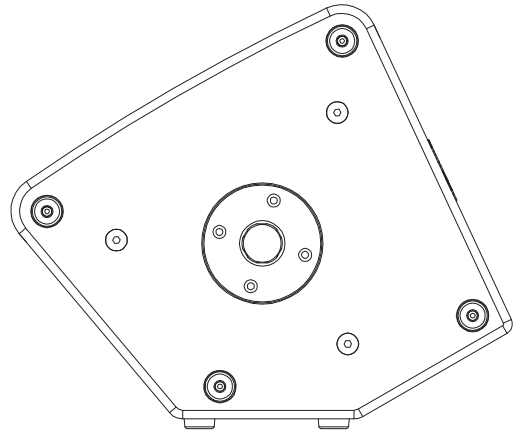

Configuring the RSX118S Subwoofer

Before you start plugging in cables, you should take a minute to decide how you want to interface your new RSX118S subwoofer. Most system set-ups fall into one of two categories: Mono or Stereo sub operation.

Mono Sub Operation

In most cases, a common (mono) sub bass setup is preferable. Low frequencies produced by a subwoofer tend to be non-directional. Since low frequency waves take so much space to develop, it is difficult for the ear to tell if sub bass is coming from the left or right side (unless you are in a very large room). Because of this phenomenon, just about all sub bass material is mixed in mono.

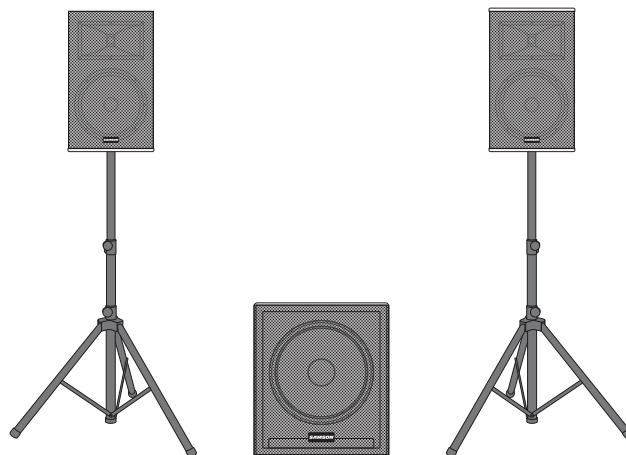

Stereo Sub Operation

In larger rooms, as well as in theaters and theme park installations (for low frequency special audio effects), two or more RSX118S subwoofers can be used in stereo. For additional low-end, you can daisy chain a pair of RSX118S subwoofers to each side of your speaker system using the parallel outputs.

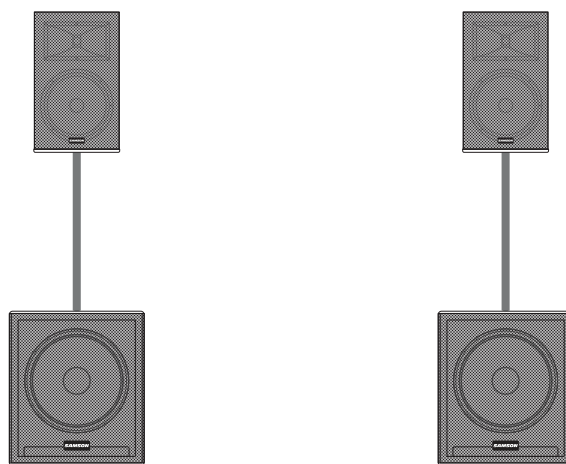

Positioning the Subwoofer

The placement of the subwoofer can affect the overall performance of your system since room acoustics may create standing waves, an acoustical phenomenon that causes certain bass frequencies to sound louder. Here are a few points you should consider when setting up your system, which can help you achieve optimal performance in your space.

The ideal placement of the subwoofer is as close to the main front of house speakers as possible, in order to blend the satellites and subwoofer. Mounting the satellite speakers on top of the subwoofer allows you to align the drivers. The closer the subwoofer is to a wall, the louder the bass frequencies will sound, and you can adjust the mix between the subwoofer and satellite speakers by moving the subwoofer closer to and further from a wall.

Avoid placing the subwoofer in a corner. This can make the subwoofer appear to be louder, but only for a limited frequency band, and will make the mix sound "boomy" and not well defined. The best way to increase the overall level of bass is to add a second subwoofer.

Using an External Crossover

The RSX118S features an 6dB/octave at 150Hz internal low pass filter, which means that frequencies will be reduced 6dB in level every time the frequency doubles. Consequently, frequencies that are in the range of the satellite speakers will be produced by the subwoofer and can create comb filtering. When configuring your sound system, you may want to use an external crossover, like the Samson S 3-way, to fine tune the crossover frequency and incorporate the subwoofer with the full-range speakers, as well as to match the room where the system is installed. The goal is to seamlessly integrate the subwoofer with rest of your speakers to extend the frequency range of your system, rather than to produce an unnatural, boomy mix. You do not want the subwoofer and the main speaker to reproduce the same frequencies, as this will create duplication of low frequencies, and create an imbalanced mix.

A good place to start is to use the frequency response of your speaker cabinets. You can usually find this information in the documentation included with your speakers. Start by setting your crossover frequency to the lowest frequency that your satellite speaker produces.

If your satellite speakers are large (12" or 15") start with a crossover frequency of 80Hz. If your speakers are small (8" or 10") start with a crossover frequency of 100Hz. If you have an oscillator (there are many free oscillator smartphone and tablet apps available), slowly sweep from 400Hz down to 40Hz, and listen to how the subwoofer and speakers blend together. You may need to raise or lower the crossover frequency control to create the smoothest frequency response. If you do not have an oscillator, use music tracks that have a steady bass line and kick drum. Slowly adjust the crossover frequency until you find the optimum setting.

Permanent Installation

The RSX series loudspeakers are a perfect solution for many fixed installations such as live sound venues, discos, schools, houses of worship, convention centers and airport terminals. The two-way speaker enclosures are extremely versatile for installation as they can be suspended in several different positions by using the twelve fly points.

IMPORTANT NOTE: Suspending an RSX loudspeaker should only be done by a qualified, licensed and insured professional sound contractor. Installation in an unsafe manner or location can result in property damage and serious injury. When installing the speaker, make sure all local ordinances are understood and adhered to. Always check and ensure that whatever structure the speaker is mounted to is devoid of cracks, deformations, or any signs of fatigue.

The RSX speakers are designed to be mounted directly to a structure. Never suspend an RSX cabinet from another speaker, and do not suspend another speaker from an RSX cabinet.

When suspended, always affix a safety cable from the RSX cabinet to the mounting structure.

A minimum of two (2) attachment points must be used when suspending the speaker enclosure. The rear and side attachment points are only used as pull-back points to adjust the angle of the speaker. Only the top and bottom fly points are load-bearing suspension points.

When suspending the RSX cabinet, it is recommended that you use an eyebolt, thimble, and shackle along with wire rope.

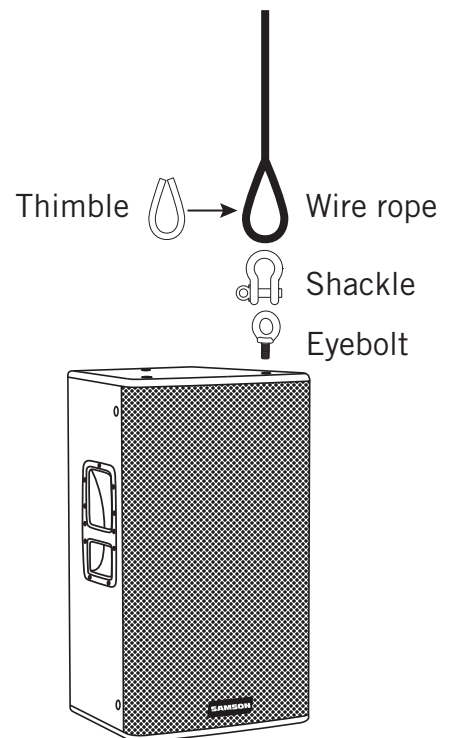

Cable Wiring

The RSX series speaker connections are made via the rear panel 1/4" and/or Speakon® connectors for easy interface with industry standard cables. Standard, unshielded speaker wire (available at your local pro audio or music store), with either 1/4" phone or Speakon connectors and wire gauge of 12–14 AWG is recommended.

If your amplifier uses binding posts you can use speaker cables with banana connectors, but be sure to pay attention to the +/- polarity when making the connections. Make sure that the + terminal of the speaker, or banana connector, is connected to the + terminal of the power amplifier, and that the - terminal of the speaker, or banana connector, is connected to the - terminal of the power amplifier. It is important that your PA system is connected in-phase, otherwise you will not have the proper low-end response and stereo image.

Use the following diagrams below to ensure proper connections when wiring your system:

Unbalanced 1/4" Connector

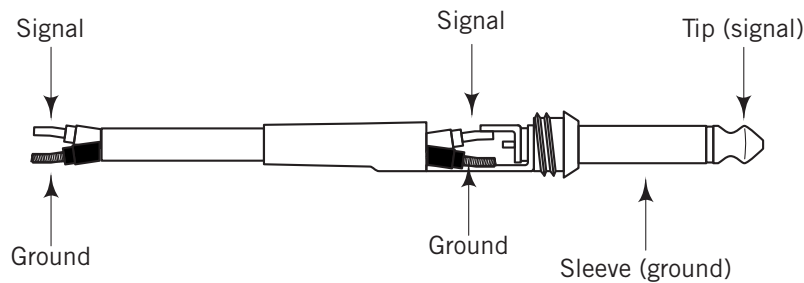

Speakon® Wiring Guide

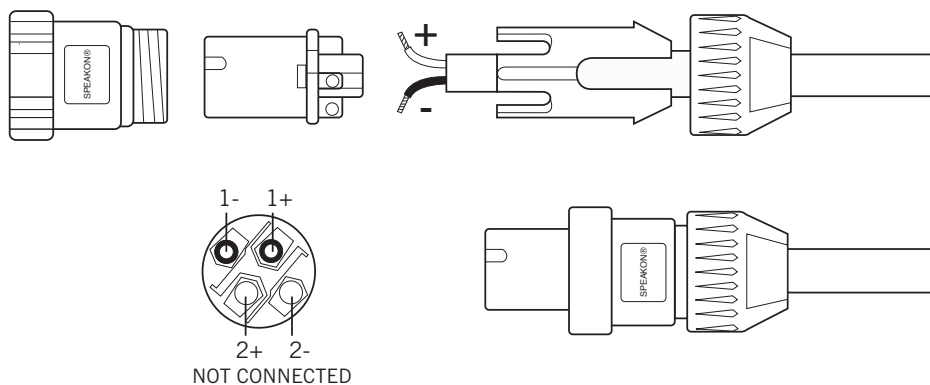

Technical Specifications

Model	RSX110	RSX112
Power Rating	200 watts AES	300 watts AES
	800 watts peak	1200 watts peak
Nominal Impedance	8 ohms	8 ohms
Frequency Response	65 Hz to 17 kHz \pm 3dB	65 Hz to 19 kHz \pm 3dB
Sensitivity (1w @ 1m)	97 dB	97 dB
Maximum SPL	127 dB SPL	132 dB SPL
LF Driver	10" (254 mm) Celestion woofer with 2" (50 mm) voice-coil	12" (304 mm) Celestion woofer with 2.5" (64 mm) voice-coil
HF Driver	Celestion 1" (25 mm) voice-coil compression driver	Celestion 1.75" (44 mm) voice-coil compression driver
HF Protection	Internal overload Lamp	Internal overload lamp
Directivity	60° x 90°	60° x 90°
Enclosure	Trapezoidal, 15 mm, 9 layer plywood cabinet	Trapezoidal, 15 mm, 9 layer plywood cabinet
Finish	Black, Textured Paint	Black, Textured Paint
Suspension	12 x fly-points, M10	12 x fly-points, M10
Transportation	Integrated carry handle	Integrated carry handle
Grille	Black, Powder Coated, perforated steel with black cloth backing	Black, Powder Coated, perforated steel with black cloth backing
Connectors	2 x Speakon® NL2, 2 x 1/4"	2 x Speakon® NL2, 2 x 1/4"
Dimensions (H x W x D)	21" x 13.1" x 12.8" (533 mm x 334 mm x 325 mm)	24.6" x 15.3" x 13.7" (625 mm x 389 mm x 350 mm)
Net Weight	31.7 lb (14.4 kg)	42.8 lb (19.4 kg)
Shipping Weight	35.2 lb (16 kg)	47 lb (21.3 kg)

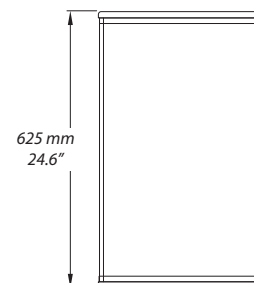
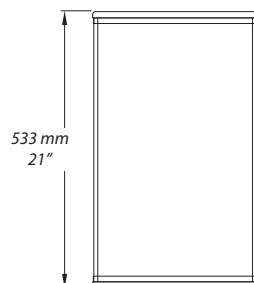
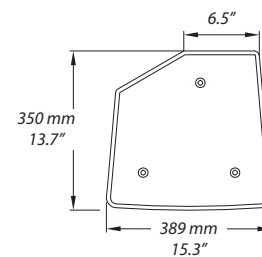
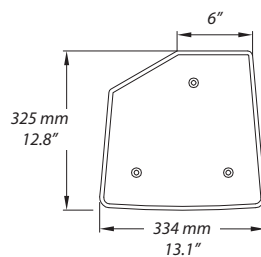

Technical Specifications

Model	RSX115	RSX215
Power Rating	600 watts AES	1200 watts AES
	2400 watts peak	4800 watts peak
Nominal Impedance	8 ohms	8 ohms
Frequency Response	50 Hz to 20 kHz \pm 3dB	40 Hz to 20 kHz \pm 3dB
Sensitivity (1w @ 1m)	98 dB	98 dB
Maximum SPL	127 dB SPL	132 dB SPL
LF Driver	1 x 15" (380 mm) woofer with 3" (76 mm) voice-coil	2 x 15" (380 mm) woofer with 3" (76 mm) voice-coil
HF Driver	Celestion 1.75" (44 mm) voice-coil compression driver	Celestion 1.75" (44 mm) voice-coil compression driver
HF Protection	Internal overload Lamp	Internal overload lamp
Directivity	60° x 90°	60° x 90°
Enclosure	Trapezoidal, 15 mm, 9 layer plywood cabinet	Trapezoidal, 15 mm, 9 layer plywood cabinet
Finish	Black, Textured Paint	Black, Textured Paint
Suspension	12 x fly-points, M10	12 x fly-points, M10
Transportation	2 x Integrated carry handles	2 x Integrated carry handles
Grille	Black, Powder Coated, perforated steel with black cloth backing	Black, Powder Coated, perforated steel with black cloth backing
Connectors	2 x Speakon® NL2, 2 x ¼"	2 x Speakon® NL2, 2 x ¼"
Dimensions (H x W x D)	28.3" x 17.4" x 15.2" (720 mm x 442 mm x 387 mm)	44" x 17.4" x 15.2" (1120 mm x 442 mm x 387 mm)
Net Weight	56.2 lb (25.5 kg)	87.34 lb (39.7 kg)
Shipping Weight	63.5 lb (28.8 kg)	96.58 lb (43.9 kg)

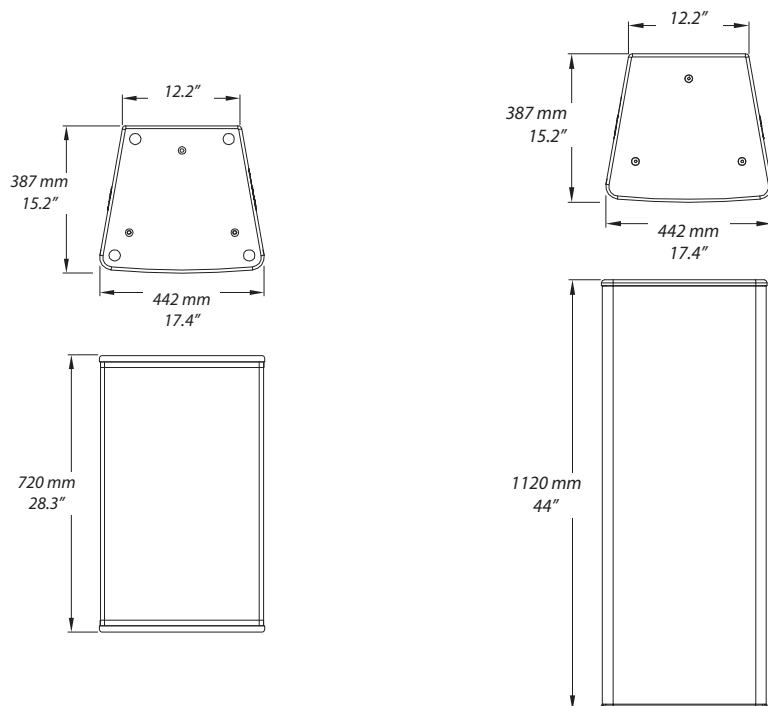

Technical Specifications

Model	RSX118S
Power Rating	500 watts AES
	2000 watts peak
Nominal Impedance	8 ohms
Frequency Response	35 Hz to 150 Hz \pm 3dB
Sensitivity (1w @ 1m)	96 dB
Maximum SPL	126 dB SPL
LF Driver	1 x 18" mm (483 mm) woofer with 3" mm (76 mm) voice-coil
Crossover	6 dB/oct LPF @ 150 Hz
Directivity	Omnidirectional
Enclosure	Rectangular, 18 mm, 11 layer plywood cabinet
Finish	Black, Textured Paint
Suspension	n/a
Transportation	2 x Integrated carry handles
Grille	Black, Powder Coated, perforated steel with black cloth backing
Connectors	2 x Speakon® NL4
Dimensions (H x W x D)	21.7" x 25.6" x 23.6" (550 mm x 650 mm x 600 mm)
Net Weight	75 lb (34 kg)
Shipping Weight	87.5 lb (39.66 kg)

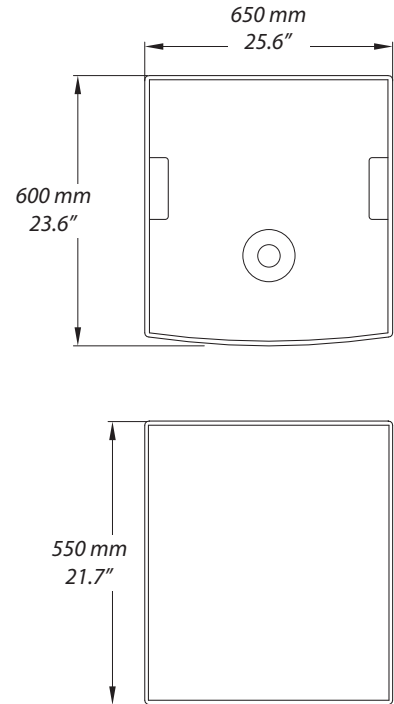

At Samson, we are continually improving our products, therefore specifications and images are subject to change without notice.

Notes

Samson Technologies Corp.
45 Gilpin Avenue
Hauppauge, New York 11788-8816
Phone: 1-800-3-SAMSON (1-800-372-6766)
Fax: 631-784-2201
www.samsontech.com