

Varizoom

VZ-M5 HDMI Field Monitor – 5” Class HD LCD

The VZ-M5 HDMI monitor provides sharp, accurate images for improved framing and focus assist on any camera equipped with an HDMI output. Utilizing top-quality Grade A+ LCD panels and image processing, the M5 offers picture quality and a feature set normally found only on more expensive monitors. Included with the basic M5 kit: monitor, HDMI cable and AC power adapter. A number of optional accessories designed specifically for the M5 are available through Varizoom.

Warnings:

- ✓ Do not use the monitor in extremely hot and humid environments.
- ✓ Never open the monitor case or attempt repair – this will void the warranty.
- ✓ Use only a soft cloth and no chemicals to clean the LCD screen.
- ✓ DO NOT USE THE AC ADAPTER AND BATTERY AT THE SAME TIME. UNPLUG AC ADAPTER WHEN USING BATTERY POWER.
- ✓ The monitor can only handle 6.5-36VDC with CORRECT polarity.
- ✓ Do not plug anything into the micro USB port on the underside of the monitor (factory use only).
- ✓ Do not plug anything into the “Zoom” port on the monitor other than the optional zoom/peaking trigger remote (**NEVER** plug a camera zoom control into this port).

Features:

- Accepts all HD signals up to 1080p
- HDMI In / Out (loop through)
- DSLR Scaling to allow full-screen viewing of image from cameras such as Canon 5D
- Auto Aspect Ratio Detection
- Monochrome (B&W) mode
- Image Flip for inverted mounting (1/4”-20 mounts on top and bottom of monitor)
- Safety Area markers (5 levels), Centerline Marker, 4:3 area markers
- Underscan and Overscan modes
- Color Temperature Presets (D65 and D93 standards), or user-defined through RGB settings
- Brightness, Contrast, Saturation, Sharpness adjustments
- Customizable Menu Options for menu duration, position, text color and language
- Headphone jack for audio monitoring

Optional Accessories:

- ❖ Zoom/Peaking Trigger Remote for pixel-to-pixel zoom mode and peaking mode to assist in focusing
- ❖ HDMI Cable locks to prevent cable from loosening or falling out
- ❖ Hard sunhood / screen protector shades screen for outdoor viewing and folds to protect screen during transport
- ❖ Battery plates for Sony, Canon, JVC, Panasonic mount to back of monitor and allow use of existing batteries
- ❖ Battery kits with charger, battery, plate
- ❖ Shock-absorbing rubber case protector sleeve
- ❖ Hard carrying case
- ❖ Soft carrying case
- ❖ Hot-shoe mount for mounting monitor on top of camera

Go to www.varizoom.com for more information on accessories

Specs

Screen Size	4-7/8" diagonal
Native Resolution	800 x 480
Brightness	500 cd/m ²
Contrast	800:1
Video Formats	1080 – 24p/24psf/25p/30p/50i/60i/50p/60p; 720 - 50p/60p; 480i; 480p; 576i; 576p
Response Time	10ms
Viewing Angle	L80° / R80° / U80° / D80°
Input Voltage	12VDC nominal (6.5 – 36VDC max range)
Mount Type	¼"-20 female (2) top and bottom
Inputs/Outputs	HDMI (in), HDMI (out), Headphone 3.5mm (out), "Zoom" (in) 3.5mm
Size	5.8" x 3.96" x 1.22"
Weight	0.74 lb
Power consumption	≤ 7.5W

Function Sketch Map

At the right you'll see a mechanical drawing of the M5 monitor. Note that items 11 (HDMI Plug Lock) and 16 (7.2V battery plate) are optional accessories (not included in this kit).

Using the Monitor for the First Time

Although this is essentially a plug-and-play type monitor, there are a few things to note before you begin using it.

- -There is a sheet of protective film covering the screen – remove this before using the monitor.
- -Do not block the air vents on the monitor
- -Do not plug anything into the “Zoom” port other than the special Zoom/Peaking Trigger Remote accessory (**NOTE: Never plug a camera zoom control into this port**).
- -Never use the AC adapter and battery at the same time – only use one power source at a time.

Connect the AC power supply to the monitor (14) and power up your camera.

Connect the HDMI cable to your camera and the monitor. If you need the HDMI signal to go to another monitor or location, use the “HDMI OUT” (13).

Turn on the power switch located at the back of the monitor (15).

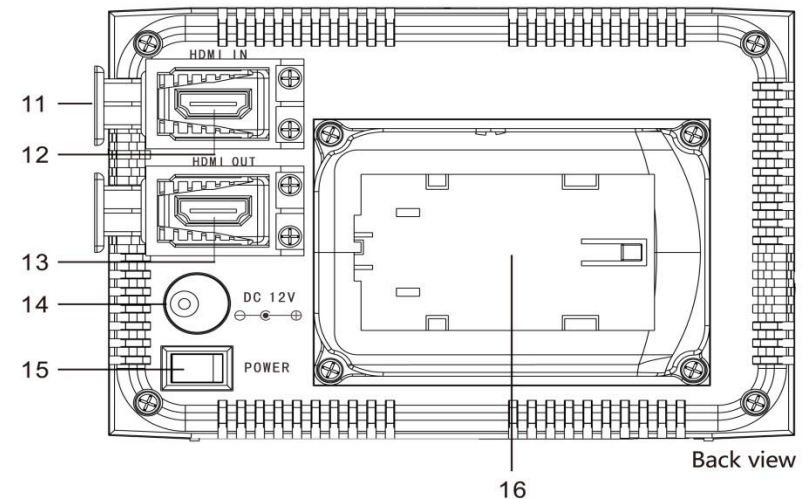
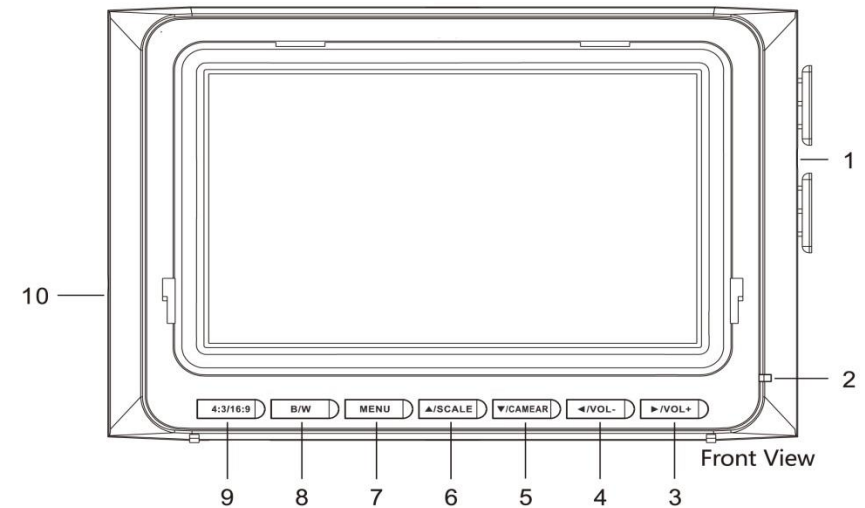

- | | |
|--|-----------------------|
| 1 Earphone jack | 9 4 : 3 / 16 : 9 |
| 2 Power Indicator(Green) | 10 ZOOM Jack |
| 3 Rightwards adjustment key/Volume Up | 11 HDMI Plug Lock |
| 4 Leftwards adjustment key/Volume down | 12 HDMI Input |
| 5 Downward adjustment key / Camera key | 13 HDMI output |
| 6 Upward adjustment key / scale key | 14 DC 12V |
| 7 Menu | 15 power switch |
| 8 Monochrome key | 16 7.2V Battery plate |

Basic Picture Settings

Aspect Ratio - The monitor should automatically detect and display the correct aspect ratio, however, you are able to manually select the aspect ratio mode by pressing the 4:3 / 16:9 button.

Color / B&W - You can also switch to monochrome mode (black & white) by pressing the B/W button. Some users find this mode useful for critical focusing.

DSLR Scaling - If you are using a DSLR camera like the Canon 5D and the image doesn't fill the monitor screen, you can press the ▼/Camera button to turn DSLR scaling "ON" to fill the screen. Otherwise, leave this setting "OFF." **NOTE: With Canon 5D Mark III, you may have to press the camera's "INFO" button a few times until the image fills the screen of the M5 monitor.**

Picture Settings - To change the picture settings (brightness, contrast, saturation, sharpness), first hit the side arrow buttons (◀/Vol- & ▶/Vol+) to enter adjustment mode, then hit the up/down arrow buttons (▲/Scale & ▼/Camera) to scroll through the setting categories.

Once you've reached the picture setting you want to adjust, use the side arrow buttons (◀/Vol- & ▶/Vol+) to make the adjustment. All other picture, display and system settings are changed through the menu system.

Advanced Menu Settings

Press "Menu" and then the up/down arrows (▲/Scale or ▼/Camera) to find the submenu you wish to enter, then press "Menu" to enter that submenu.

Once in the submenu, use the up/down arrows (▲/Scale or ▼/Camera) to select the setting you wish to change and then press "Menu" to activate the desired setting.

A diagram of the menu settings on the next page maps out all the features and settings available through the menu.

The VZ-M5 monitor is covered by a limited one-year warranty for parts & labor. This warranty does not cover failures caused by damage or abuse (e.g., plugging incorrect power into monitor, cracked screens cause by impact) www.varizoom.com

Functional Menu

Function
Enter from MENU

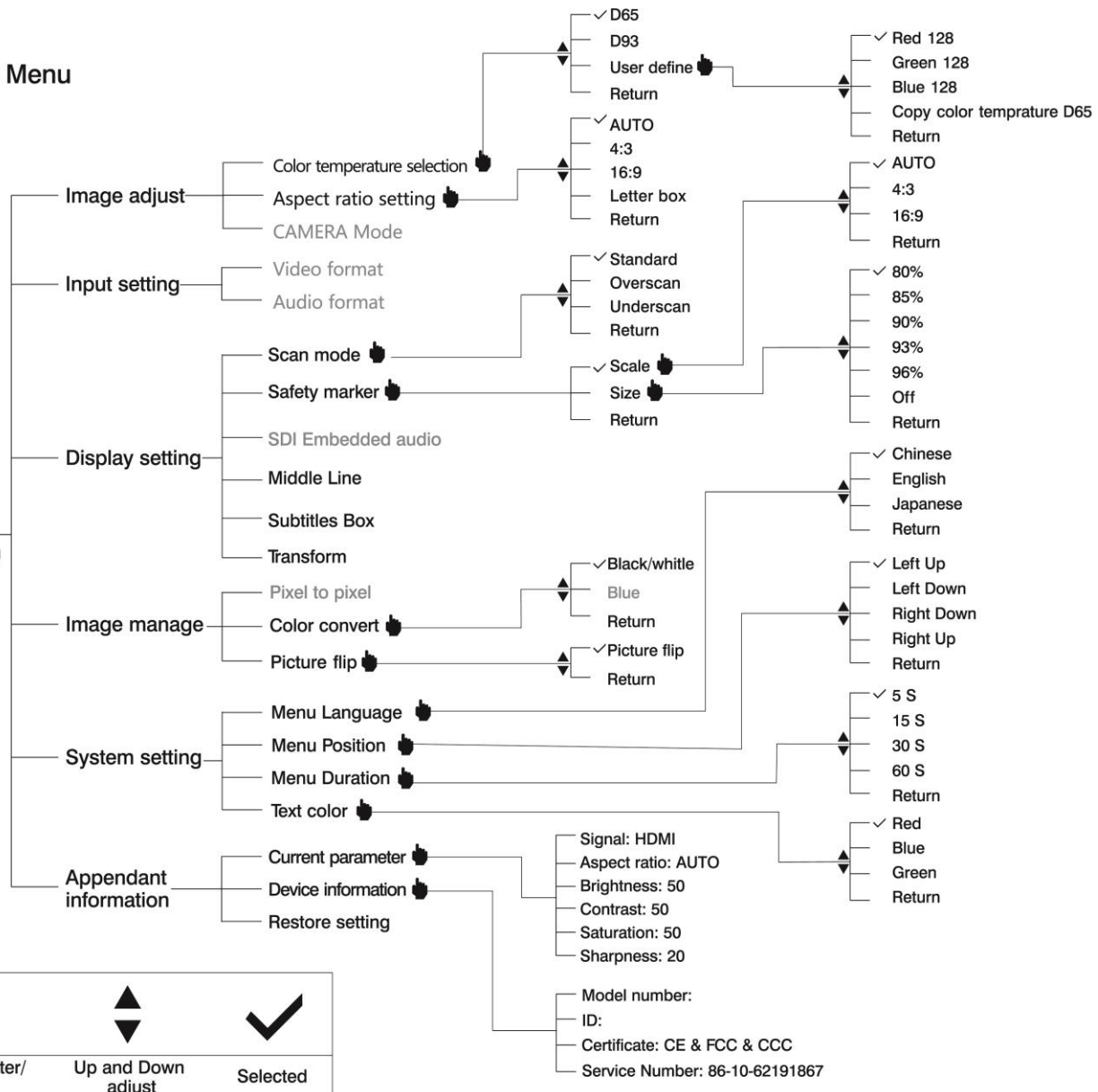

Press to enter/ select	Up and Down adjust	Selected

It is ✓ when it was selected. Remark: It is unavailable if the option text is gray.

■ Please set the Color temprature to D65 when it is used for field monitoring.
■ The scan mode only can be adjusted when the Aspect ratio is AUTO .



Optional Folding Sunhood/Screen protector



Optional Rubber Case Protector



Optional HDMI Cable Locks



Optional Zoom / Peaking Trigger Remote

Go to www.varizoom.com for accessory info

Optional Accessory Function Introduce

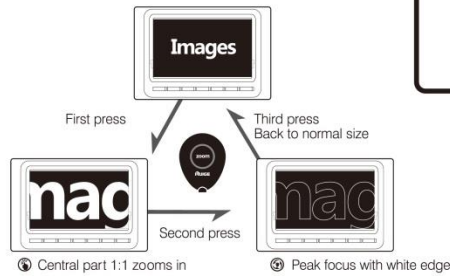
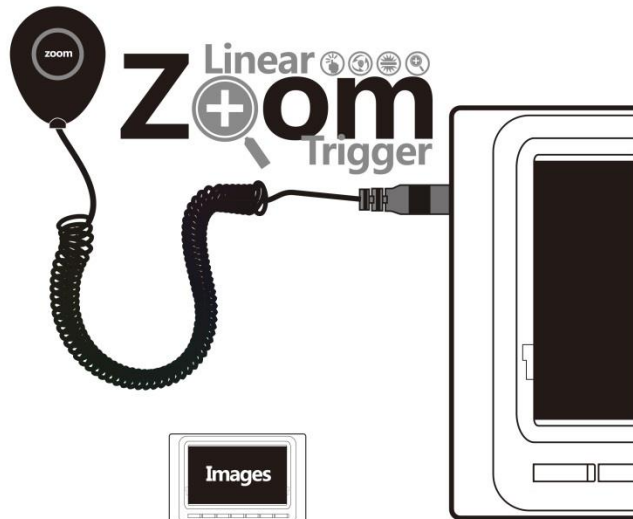

Optional accessory---Linear Zoom trigger could realize peak focus function, which greatly save focus time and optimize focus effect. It ensures you capture every wonderful moment.

- First press(ZOOM) key, central part of the screen 1:1 pixel zoom in
- Second press (ZOOM) key, a white edge comes to the object to help you focus.
- Third press (ZOOM) key , back to normal size

■ This function is only valid with this Linear zoom trigger operation.

Optional accessory installtion method/
Power input



i. HDMI plug lock

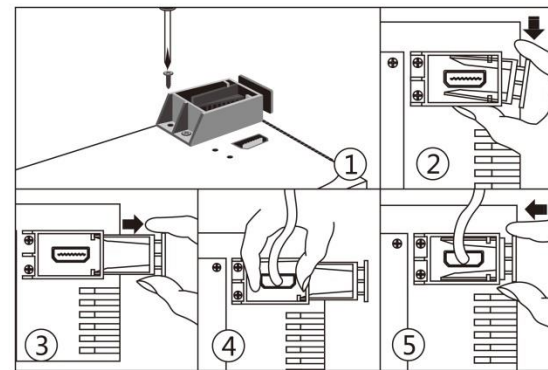

ii. DV battery plate

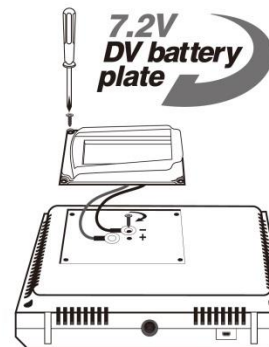

- Pay attention to the polarity (Positive in red, negative in black)
- Please choose the suitable battery plate according to your battery.

iii. Power cord

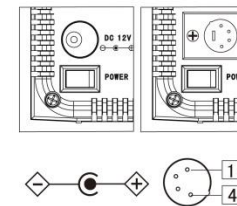

1. AC-DC adapter(Standard accessory)
2. Battery plate(Optional accessory)
3. D-Tap power cable(Optional accessory)
4. If you use your own DC power equipment, kindly take above sketch map as reference, especially for the polarity.