

**PRESSURE
ZONE
MICROPHONE®**

SOUND GRABBER II

The Sound Grabber II is an updated version of the original Sound Grabber. It utilizes the same Pressure Zone Microphone® technology in which sound waves reinforce themselves in the area nearest a flat surface, usually referred to as the boundary.

Top recording engineers all over the world are using professional versions of the Crown PZM (Pressure Zone Microphone) to improve the quality of their recordings. The Sound Grabber II is one version of that technology, designed to meet the needs of the home or business recordist and bring the benefits of PZM technology within the reach of many more people.

Because of this new technology, Sound Grabber II offers you the opportunity for vast improvement in the quality of your recordings. The Sound Grabber II will pick up sounds at distances you never thought possible and it will pick them up with a clarity that other microphones, because of the limitations of their construction, simply cannot match.

The Sound Grabber II does not need to follow the action, since it has a wide-angle pickup pattern. So long as the mic "sees" the sound, in whatever direction or angle, it will pick it up clearly; it does not need to be between you and the other person. Speakers or vocalists can move freely around the Sound Grabber II without their tone quality changing.

For your greatest enjoyment of the Sound Grabber II, we urge you to read these instructions thoroughly so you can be familiar with this new technology.

Installing the Battery

The Sound Grabber II is powered with an alkaline 1.5 volt AAA battery. One is furnished with the microphone, but it must be inserted into the microphone.

Your battery will supply the needed power for the microphone for at least six weeks and possibly much longer.

To install the battery open the cover (see Fig. 1) and insert the AAA battery. Please make the correct orientation.

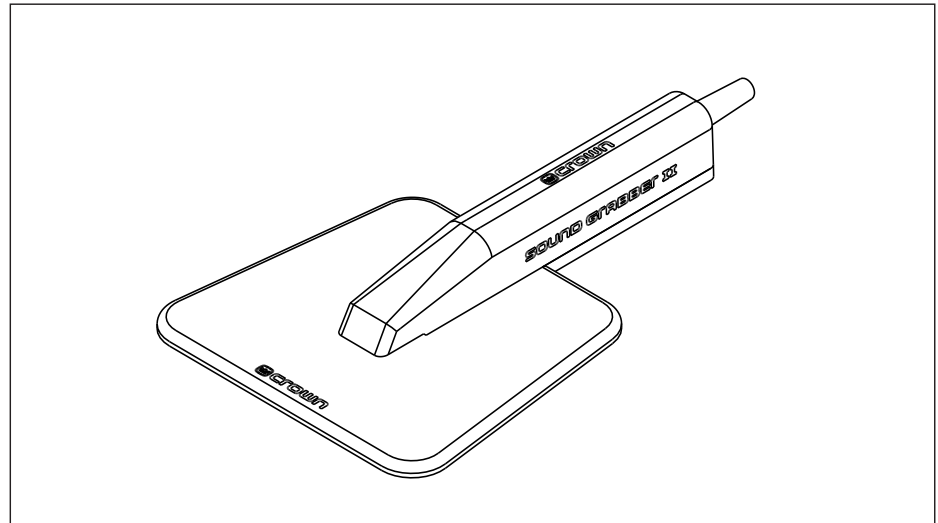
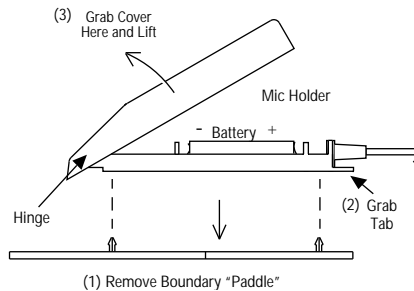

Fig. 1



Using the Sound Grabber II

Conferences Recording

Place the Sound Grabber II flat on the conference table somewhere near the center of the table. One microphone should be able to pick up groups of twelve or less at distances up to 20'. Larger groups may require additional mics depending on the distances involved. See Fig. 2.

Fig. 2



The Sound Grabber II should not be covered with papers or books, as this could make the sound muffled.

Specifications

Frequency response (typical): 50 Hz to 16 kHz (see Fig. 3).

Polar pattern: Hemispherical (half-omni) on a large surface.

Impedance: 1600 ohms, unbalanced.

Sensitivity: 20 mV/Pa* (-54 fBV/Pa).

Power sensitivity: -42 dBm.

Cable: 10 foot with mini phone plug, 1/4" phone plug and micro phone plug adapters.

Power: One 1.5V AAA alkaline battery.

Dimensions: See Fig. 4.

*1 pascal = 10 dynes/cm² = 10 microbars = 94 dB SPL.

Fig. 3

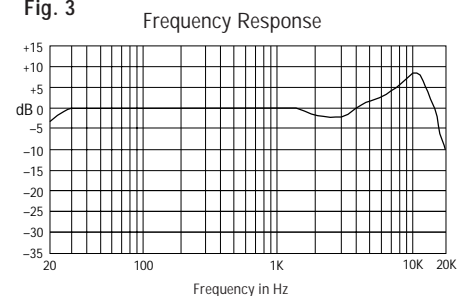
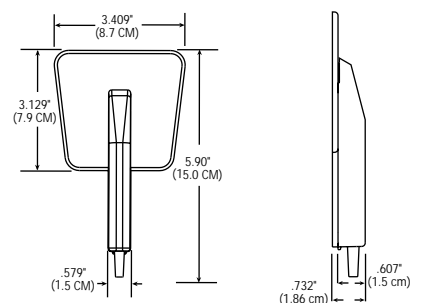

Fig. 4



SOUND GRABBER II

Should you wish to record a conference group which is meeting without a table, the Sound Grabber II could be placed on the floor in the middle of the group or on a wall. Double-faced adhesive tape can be used, providing the wall finish will not be damaged.

Interviews

For two-person interviews, see Fig. 5. If the interview is being recorded on television, the mic can easily be positioned out of the camera range and still have excellent audio pickup.

Fig. 5

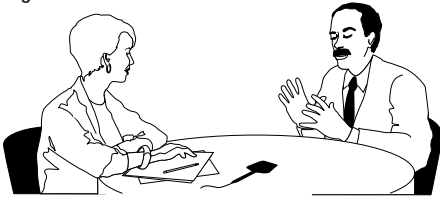

Interviews can also be miked with the Sound Grabber II mounted on the ceiling or in an overhead light fixture.

Pulpits, Lecterns

Because it lies flat on any surface, the Sound Grabber II is ideal for picking up speech at a lectern or pulpit. It is invisible to the audience and can be placed anywhere on the surface so as not to interfere with any books or papers. See Fig. 6.

Cassette Recording

The Sound Grabber II is equipped with an 8 foot cord with a 1/8" mic plug. A micro plug and 1/4" phone-plug adaptors are also provided.

The Sound Grabber II will provide an output signal that will record easily on any standard

Fig. 6

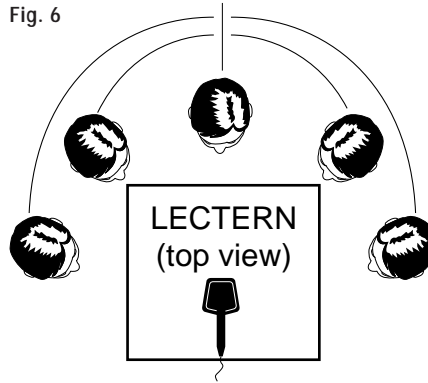

cassette recorder. Because of the mic's novel design, you probably will find that your recorder performs better than it ever has before.

Video

For video recording with a fixed camera position, simply plug the mic into the camera and position the mic as needed for the type of recording you are doing. If the camera will be moving, you can tape the mic to the front of the camera or ask an assistant to hold the mic.

Stereo Recording

Mount two Sound Grabber IIs head high on a wall or on the floor and about 3 to 10 feet apart, facing the performers. The mics should be 5' to 15' from the performers (see Figs. 7 and 8).

Warranty

Crown professional microphones are guaranteed unconditionally against malfunction from any cause for a period of one year from date of original purchase. Please refer to the blister pack for more details.

Fig. 7

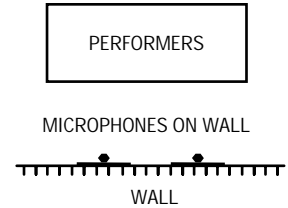
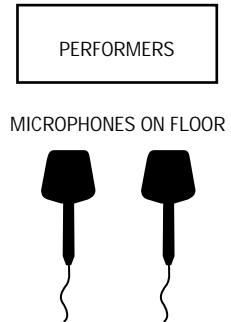
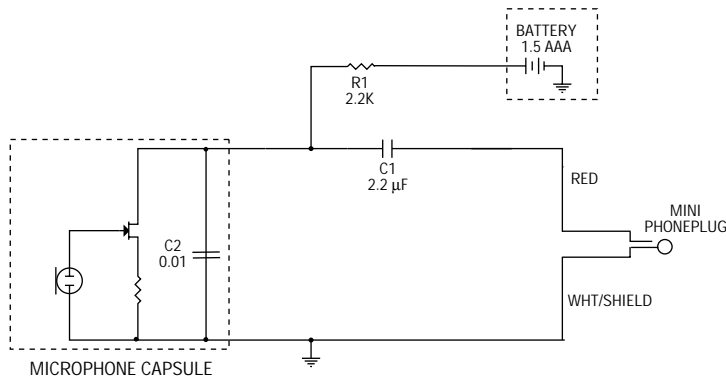

Fig. 8



Service

If the microphone does not function properly, check that it is aimed correctly and is connected as described in this data sheet. If service is required, return the microphone in its original packaging to Crown's Service Department at Plant 2 SW, 1718 West Mishawaka Road, Elkhart, Indiana 46517. For further assistance or technical support call 800-342-6939.



Sound Grabber II Schematic



Crown International, Inc.
P.O. Box 1000
Elkhart, IN 46515-1000
TEL: 219-294-8000
FAX: 219-294-8FAX

©1998 Crown International, Inc.
Specifications subject to change without prior notice.
Crown®, PZM® and Pressure Zone Microphone® are registered trademarks of Crown International, Inc.
Pressure Recording Process™ is a trademark of E. M. Long Associates.