

ALLEN & HEATH



XONE:42

USER GUIDE

Publication AP6857

Limited One Year Warranty

This product is warranted to be free from defects in materials or workmanship for period of one year from the date of purchase by the original owner.

To ensure a high level of performance and reliability for which this equipment has been designed and manufactured, read this User Guide before operating. In the event of a failure, notify and return the defective unit to ALLEN & HEATH Limited or its authorised agent as soon as possible for repair under warranty subject to the following conditions

Conditions Of Warranty

The equipment has been installed and operated in accordance with the instructions in this User Guide.

The equipment has not been subject to misuse either intended or accidental, neglect, or alteration other than as described in the User Guide or Service Manual, or approved by ALLEN & HEATH.

Any necessary adjustment, alteration or repair has been carried out by ALLEN & HEATH or its authorised agent.

This warranty does not cover fader wear and tear.

The defective unit is to be returned carriage prepaid to ALLEN & HEATH or its authorised agent with proof of purchase.

Units returned should be packed to avoid transit damage.

In certain territories the terms may vary. Check with your ALLEN & HEATH agent for any additional warranty which may apply.

This product complies with the European Electro magnetic Compatibility directives 89/336/EEC & 92/31/EEC and the European Low Voltage Directives 73/23/EEC & 93/68/EEC.

This product has been tested to EN55103 Parts 1 & 2 1996 for use in Environments E1, E2, E3, and E4 to demonstrate compliance with the protection requirements in the European EMC directive 89/336/EEC. During some tests the specified performance figures of the product were affected. This is considered permissible and the product has been passed as acceptable for its intended use. Allen & Heath has a strict policy of ensuring all products are tested to the latest safety and EMC standards. Customers requiring more information about EMC and safety issues can contact Allen & Heath.

XONE:42 User Guide AP6857 Issue 4

Copyright © 2007 Allen & Heath Limited. All rights reserved

Allen & Heath Limited

Kernick Industrial Estate, Penryn, Cornwall, TR10 9LU, UK

<http://www.allen-heath.com> <http://www.xone.co.uk>

PACKED ITEMS

Check that you have received the following:

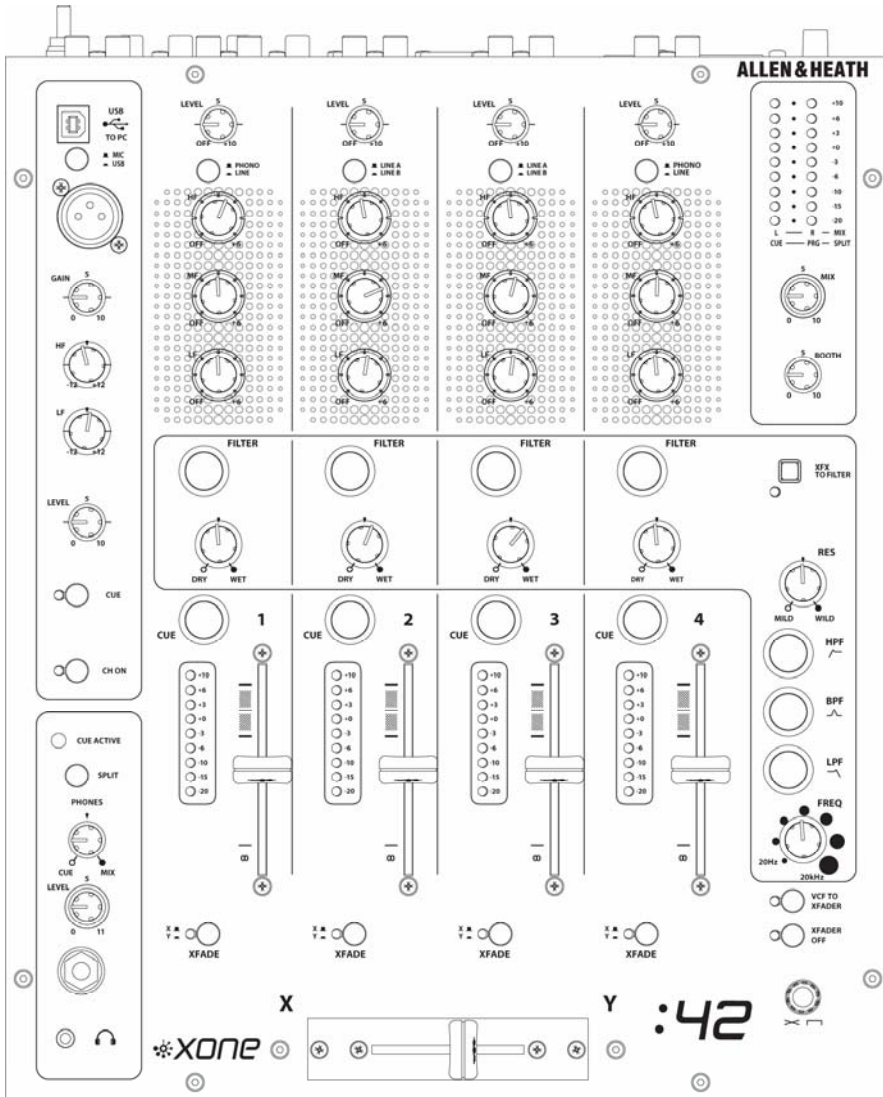

Xone:42 mixer

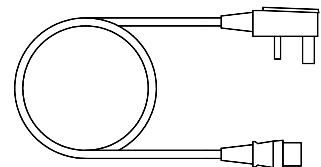

Mains Lead

Check that the correct mains plug is fitted.

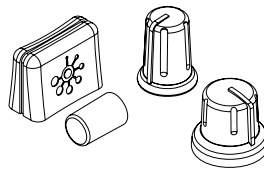

Spare knobs and buttons



Safety Sheet
Important ! Read this sheet before starting.
 Retain for future reference.

Registration Card

Complete and return to Allen & Heath to register your product.



CONTENTS

Congratulations on purchasing the Allen & Heath Xone:42 performance DJ mixer. To ensure that you get the maximum benefit from the unit please spare a few minutes familiarizing yourself with the controls and setup procedures outlined in this user guide. For further information please refer to the additional information available on our web site, or contact our technical support team.

<http://www.xone.co.uk>

<http://www.allen-heath.com>

Warranty.....	2
Packed Items	3
Contents	4
Panel Drawings	5
Introduction	6
Specifications.....	7
Block Diagram	8
Mic / USB Channel Input.....	9
Phono / Line Input Channels 1 and 4.....	11
Line / Line Input Channels 2 and 3	13
Filters Section	14
Headphone Section	16
Master Section.....	17
Crossfader	18
Rear Connectors	19
USB Connection	22
Filter Reference.....	23
Operating Levels	24
Earthing	25
Replacing the Crossfader / Face Plate.....	26
User-Replaceable Parts.....	27

“You’ve tried it your way, now try it ours ...”

PANEL DRAWINGS

Rear Panel

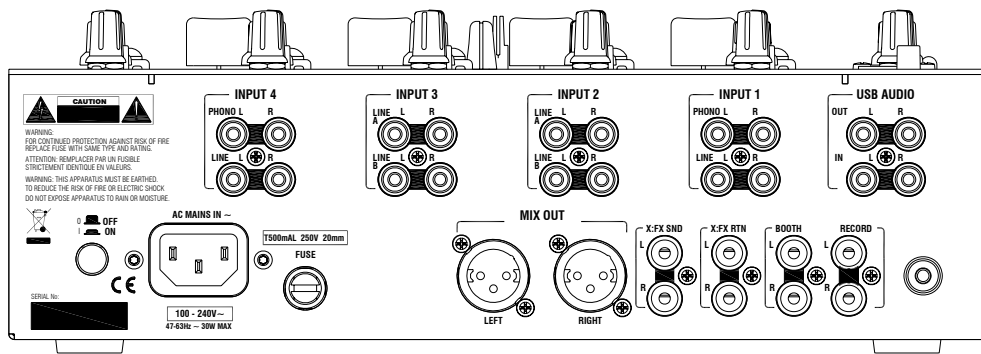

Front Panel

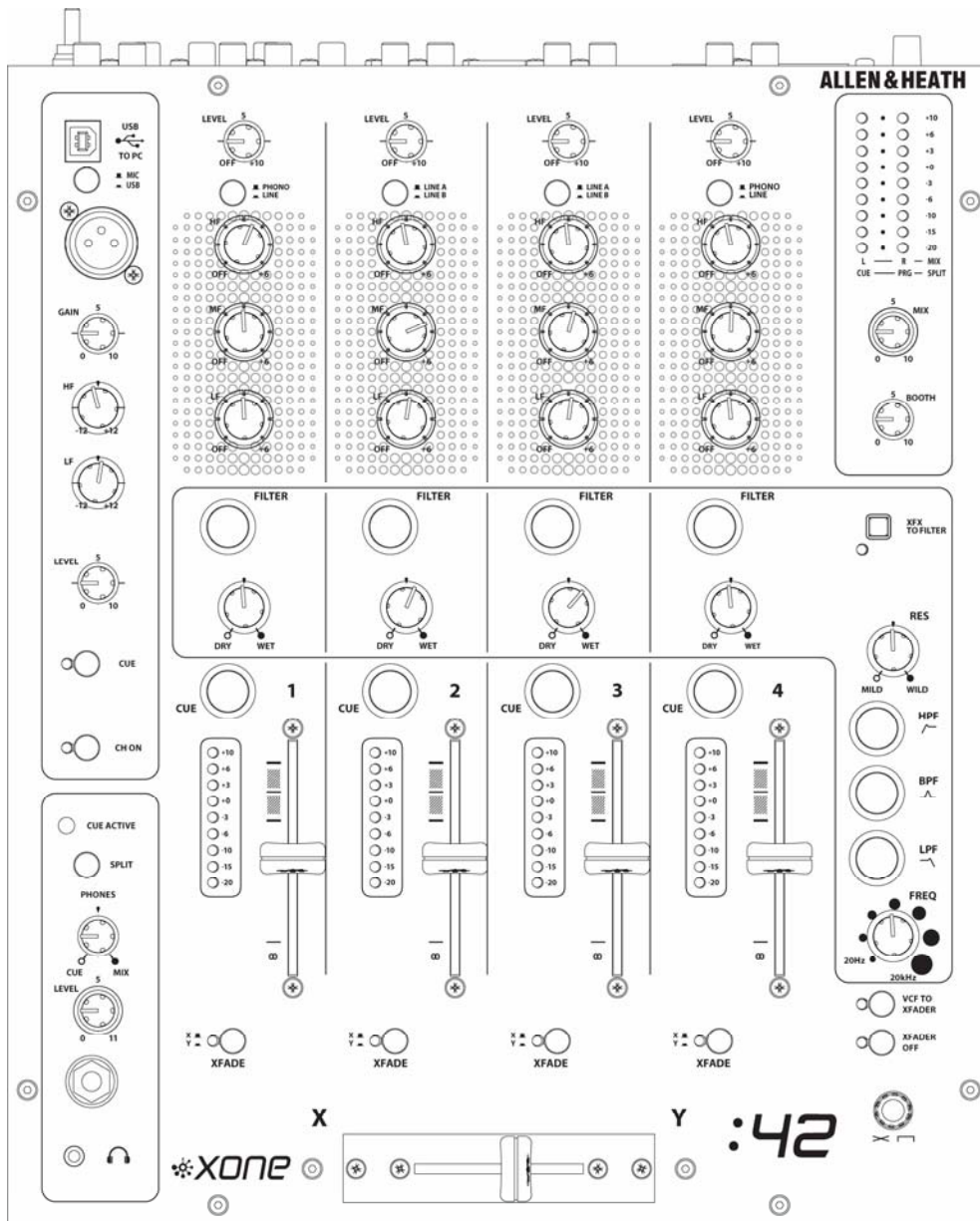

INTRODUCTION TO THE XONE:42

The Xone:42 is a high performance 12" analogue DJ mixer featuring four stereo dual input channels, a Mic/USB channel, 60mm linear VCA channel faders, an analogue VCF filter, and the new X:FX external effects loop with wet/dry control.

This mixer is designed to seamlessly interface with current leading-edge DJ technology, and may be used by the widest range of DJs - from those who keep it in the bedroom, to regular performers and professionals. The same rugged build quality of vertical circuit board construction that is used throughout the Xone range ensures that the Xone:42 can deal with any environment expected of it, and its ergonomic, intuitive layout and stylish graphics make the Xone:42 one of the most easy-to-use hi-tech mix tools around.

Each of the four main stereo channels is equipped with a powerful three band equalizer providing a safe +6dB of boost and total kill for complete frequency isolation. Nine point metering on each channel allows for precise matching of signal levels, and smooth VCA faders help to ensure a perfect mix. Individual channels can be routed to either side of the 45mm VCA crossfader, which has an adjustable curve control for smooth mixes or virtually instant attack suitable for scratching.

The Xone:42 incorporates the X:FX system that enables an external effects processor to be easily interfaced, with a single knob controlling the proportion of the channel signal sent to the effects unit, from 0% (dry) to 100% (wet).

The Xone:42 is also equipped with the legendary Xone VCF filter system. Each of the four main channels can be individually routed to the filter, and the X:FX Return to Filter function allows channel signals that have been through an external effects unit to be subsequently routed through the filter. Three basic filter types can be selected: hi-pass, band-pass and low-pass. These filter types can be added together to create other filter types; for example, hi-pass and low-pass together create a notch filter. Each filter type can be swept from 20Hz to 20 kHz by the rotary frequency control, whilst resonance can be set from "mild" to "wild". A filter reference is included towards the end of this User Guide.

The mixer incorporates a USB audio interface for easy connection to a computer and integration of digital media. It can be used to play back music files from a laptop and to record mixes from the Xone:42, or when used with appropriate software, as a digital DJ effects unit that can be patched into the X:FX. The USB input combines with an XLR microphone input to provide an additional channel with two band +/- 12dB EQ and rotary level control.

A powerful headphone amp ensures more than adequate monitor level, while two separate headphone sockets are provided on 3.5mm and 1/4" Jack. A split cue feature allows the cue signal to be monitored in the left headphone and the main mix in the right.

The master section has individual controls for the main mix and booth. Stereo nine point output meters display the post master level output, or the pre-fade source level when a cue is selected. In split cue mode the left meter displays the cue level and the right meter the master output.

A dedicated booth output, record out at -8dBu, and balanced main mix outputs on XLR round off the Xone:42's impressive list of features.

SPECIFICATIONS

Nom / max output levels	Main Mix	+4dBu	+27dBu
	Booth	0dBu	+22dBu
	X:FX Send	0dBu	+20dBu
	Record Out	-10dBV	+10dBV
Internal headroom	Channels +22dB		
Frequency response	+/-0.5dB 10Hz - 20kHz		
Distortion	< 0.03% THD+noise @1kHz		
Crosstalk	< -90dB inter-channel		
Mic EIN 22Hz-22kHz	-126dB 150 ohm source		
Residual noise	Mix I	-94dBu	
	Booth	-101dBu	
	X:FX	-92dBu	
	Rec	-95dBu	
Mix noise	Mix I	-80dBu (-84dB S/N)	
	Booth	-84dBu (-82dB S/N)	
	X:FX	-88dBu (-84dB S/N)	
	Rec	-90dBu	
Channel meters	Peak reading 9 LED -20dB to +10dB		
Main meters	Peak reading 9 LED -20dB to +10dB		
Mic EQ	2-Band +/-12dB		
Channel EQ	3-Band +6dB / total kill		
Channel fader	60mm stereo VCA, < -90dB shutoff		
Crossfader	45mm stereo VCA - replaceable		
Filters	Stereo VCF, analogue		
Consumption	30W max		

Dimensions and Weights

The console is fitted with rubber feet for desktop operation.

	Width	Height	Depth	Weight
Mixer	305 mm (12")	84 mm (3.3")	358 mm (14")	5 kg (11 lbs)
Packed	490 mm (19.5")	205 mm (8.1")	450 mm (17.7")	7 kg (15.4 lbs)

BLOCK DIAGRAM

XONE:42 BLOCK DIAGRAM

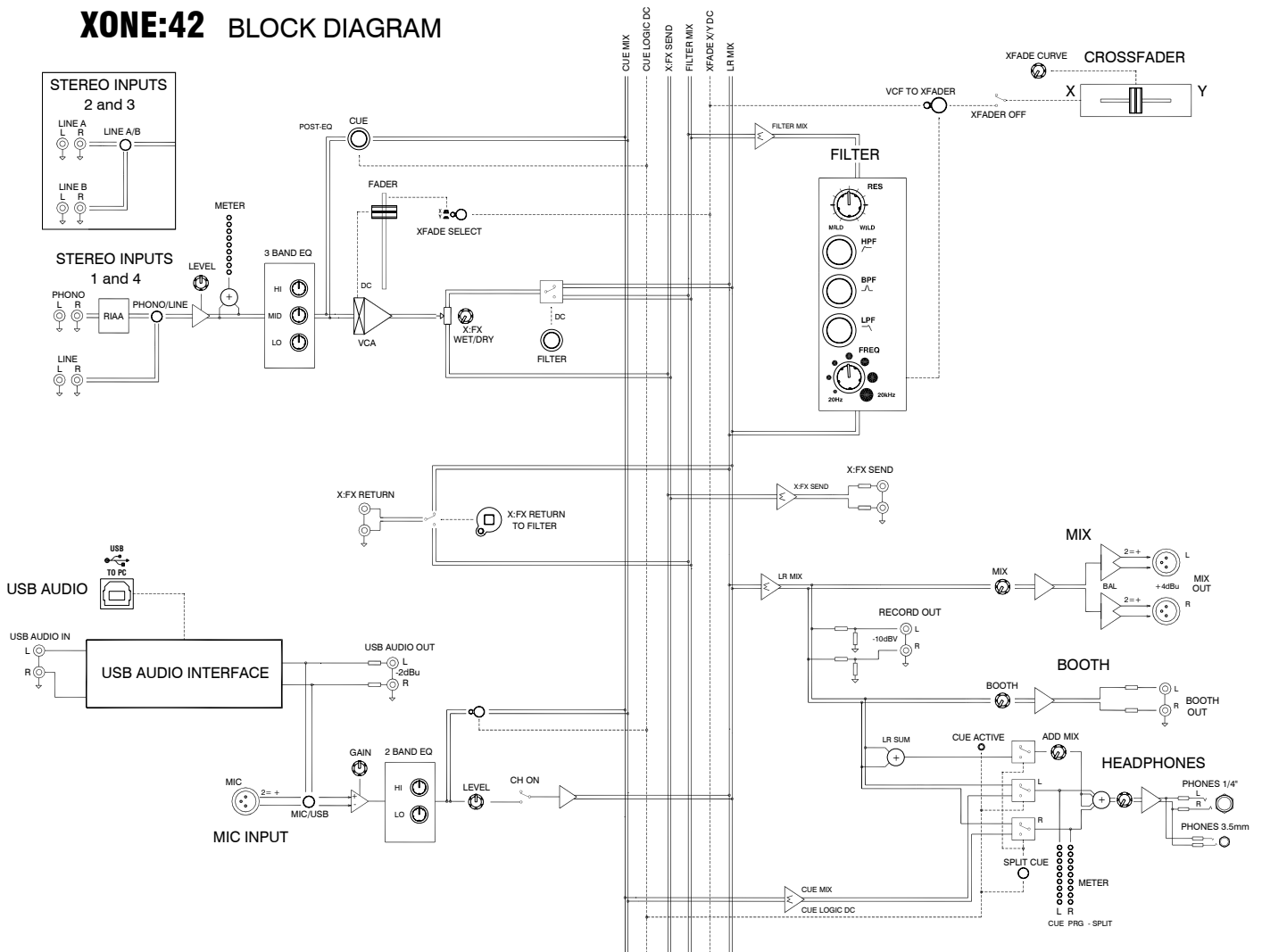

MIC / USB INPUT CHANNEL

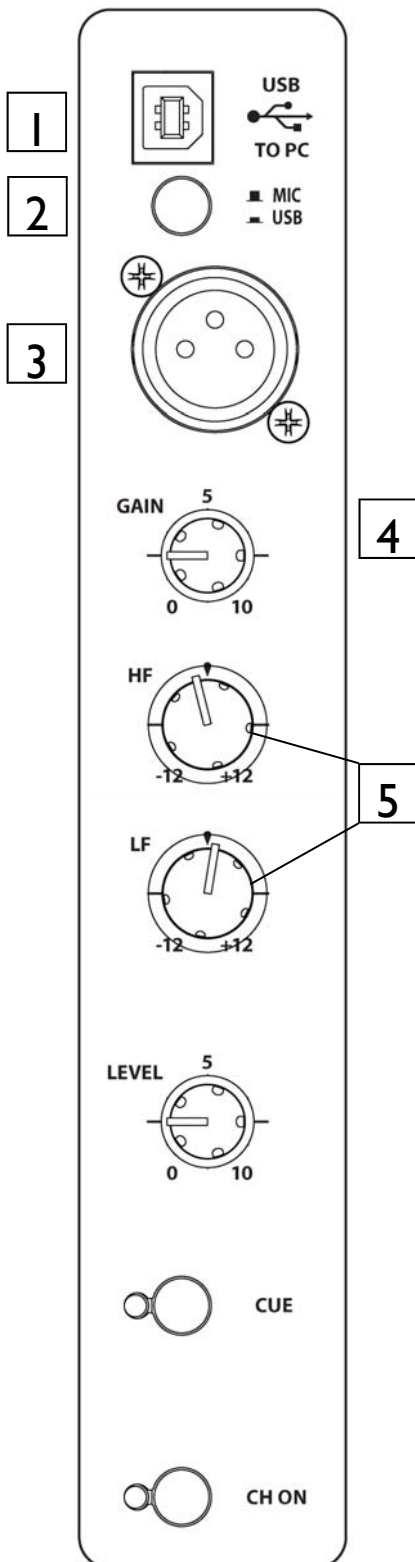

1 USB Connector

USB (Universal Serial Bus) V1.1 is an external peripheral interface standard for data transmission. Xone:42 USB works at 12Mbps and provides two stereo uncompressed audio channels - one stereo up and one stereo down, or two mono up, two mono down. It is fully compatible with USB2.

The USB connection is used to send and receive audio data between the Xone:42 and a connected computer. Use a standard type A to B lead to connect to your computer.

2 Mic / USB Select Switch

Selects either the XLR microphone input or the alternative USB input. In the up position MIC is selected; when pressed, USB is selected.

3 Mic Input Socket

Standard 3-Pin XLR socket wired as Pin 1 = Ground, Pin 2 = hot (+), Pin 3 = cold (-).

4 Channel Gain Control

This control has a range of $-\infty$ dB to +9dB for USB inputs and a range of -57 dBu to -27 dBu for MIC inputs. Use it to adjust the signal level of an audio source to give a nominal 0dB reading on the main meters, with the peak level at or below 6dB. Turn LEVEL down if the +10 peak meter starts flashing.

5 Channel Equaliser

The Mic/USB input channel is equipped with a 2 band EQ stage providing +12dB of boost when fully clockwise and -12 dB attenuation when fully anti-clockwise.

MIC / USB INPUT CHANNEL

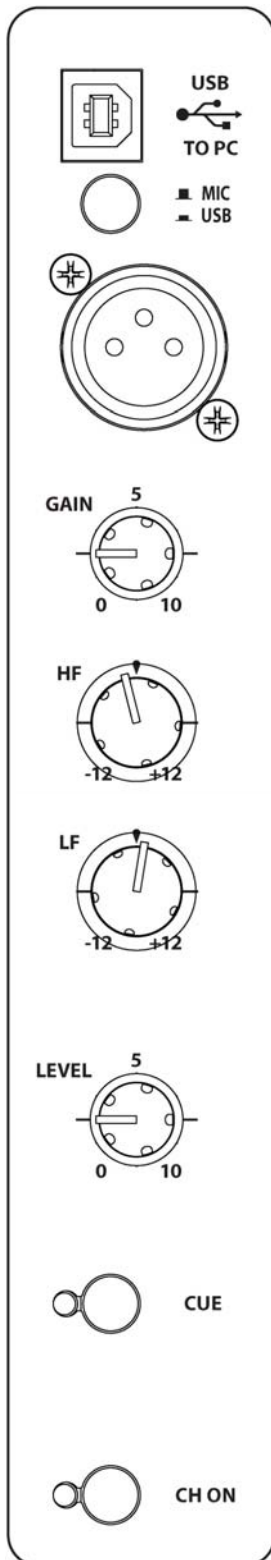

6

Channel Level Control

The channel signal level can be adjusted from fully off to fully on.

7

Cue Switch

Press the Cue switch to listen to the channel pre-fade signal in the headphones and view its level on the main meters. The red LED indicator next to the switch lights when selected. The Cue LED indicator in the monitor section also lights to warn that you are monitoring the channel signal rather than the main mix. Press the switch again to deselect cue.

8

Channel On Switch

Press the Channel On switch to send the channel audio to the mix. When selected, the green LED indicator will illuminate.

6

7

8

PHONO / LINE INPUT CHANNELS 1 and 4

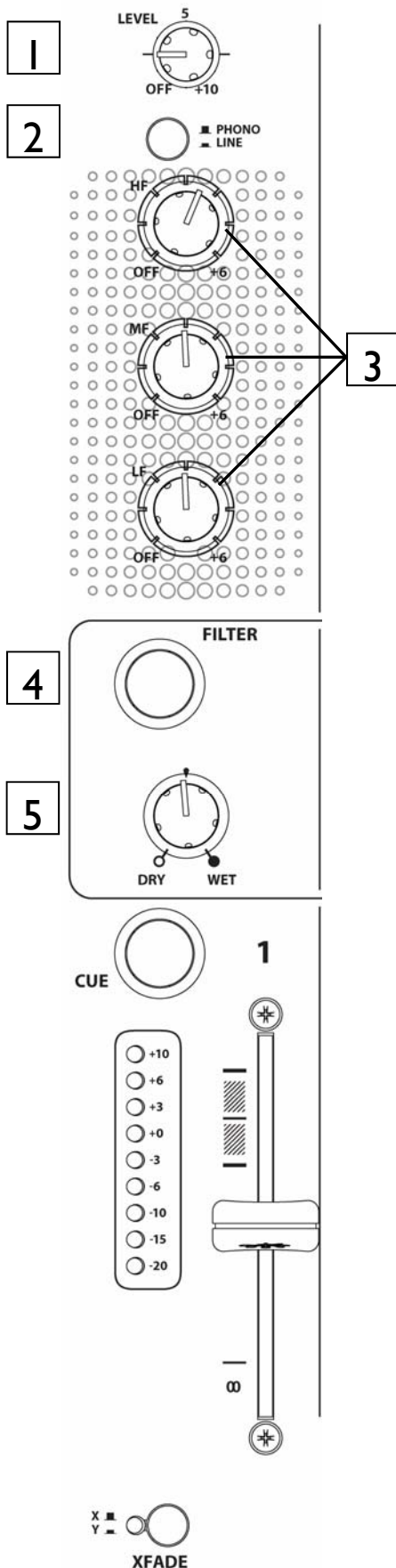

1 Channel Level Control

This control has a range of off to +10dB. Use it to adjust the signal level of an audio source to give a nominal 0dB reading on the channel meter, with the peak level at or below 6dB. Turn LEVEL down if the +10 peak meter starts flashing.

2 Phono / Line Select Switch

Selects either the RCA phono input or the alternative RCA stereo line input. In the up position PHONO is selected; when pressed, LINE is selected.

3 Channel Equalizer / Isolator

The Xone:42 is equipped with a very powerful 3 band EQ stage providing a controlled +6dB of boost when fully clockwise, but full isolation (cut) of each band for dramatic effect when fully anti-clockwise. Centre frequencies are set at:

- HF = 2.7kHz (high frequency, treble)
- MF = 1.2kHz (mid frequency)
- LF = 420Hz (low frequency, bass)

4 Filter Select

Press this switch to route the channel signal through the VCF filter. The switch will illuminate to indicate that the channel is being sent to the filter.

5 X:FX Dry / Wet Send

Use this control to vary the amount of channel signal that is sent to an external effects device connected to the X:FX send / return on the rear panel. With this control set to 'dry', none of the signal is routed to the external effects loop; if the filter button is illuminated, all of the channel signal is filtered. With the control in the central position, half of the signal is sent to external effects, while the other half is unaffected or, if filter is selected, filtered. With the control set to fully 'wet', all of the signal is sent to external effects and the VCF filter is bypassed.

PHONO / LINE INPUT CHANNELS 1 and 4

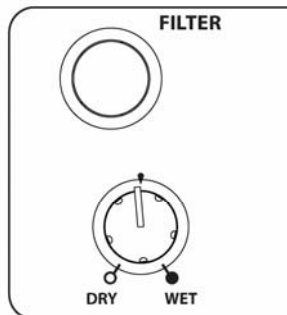
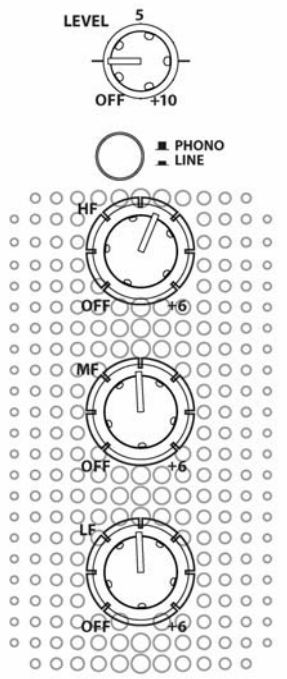

6



7

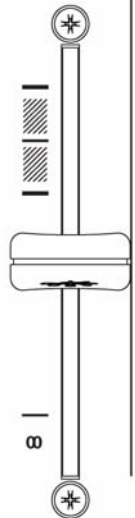
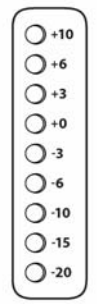

8



9

6

Cue Switch

Press the Cue switch to listen to the channel pre-fade signal in the headphones and see its level on the main meters. The LED indicator next to the switch lights when selected. The Cue LED indicator in the monitor section also lights to warn that you are monitoring the channel signal rather than the main mix. Press the switch to deselect cue.

7

Channel Meter

Displays the channel signal level. It is pre-EQ and pre-fader, allowing the input level to be displayed even if the EQ is set to off on all bands. To view the post EQ level, press the cue switch and use the mix/monitor meters.

The channel level control should be set so that the meter averages around '0' with loudest peaks no higher than '+6'. Turn down the level control if the +10 peak indicator lights.

8

Channel Fader

A high quality, smooth travel dual-rail fader adjusts the channel signal level from fully off to fully on.

9

XFade Switch

Used to assign the channel to either the X (left) or Y (right) side of the cross-fader. Works in conjunction with the XFADER On switch in the master section.

A bi-colour LED indicator illuminates either green (X) or red (Y) to show which side of the cross-fader has been selected.

LINE / LINE INPUT CHANNELS 2 and 3

I

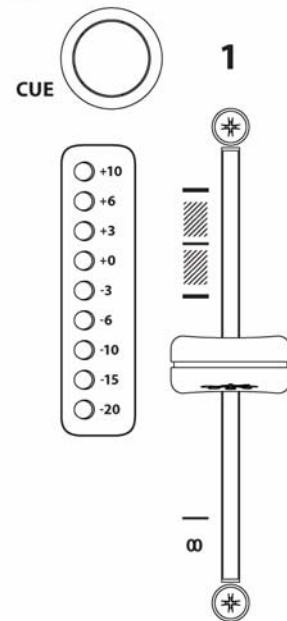
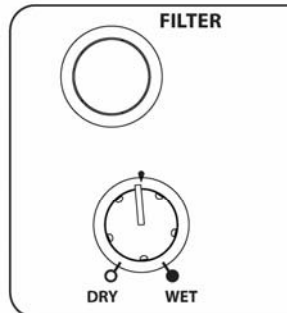
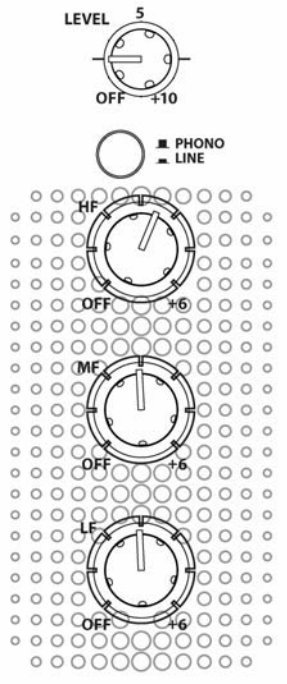

I

Line A/B Select Switch

Switches between the two RCA stereo line inputs available on Channels 2 and 3. In the up position LINE A is selected; when pressed, LINE B is selected.

FILTER SECTION

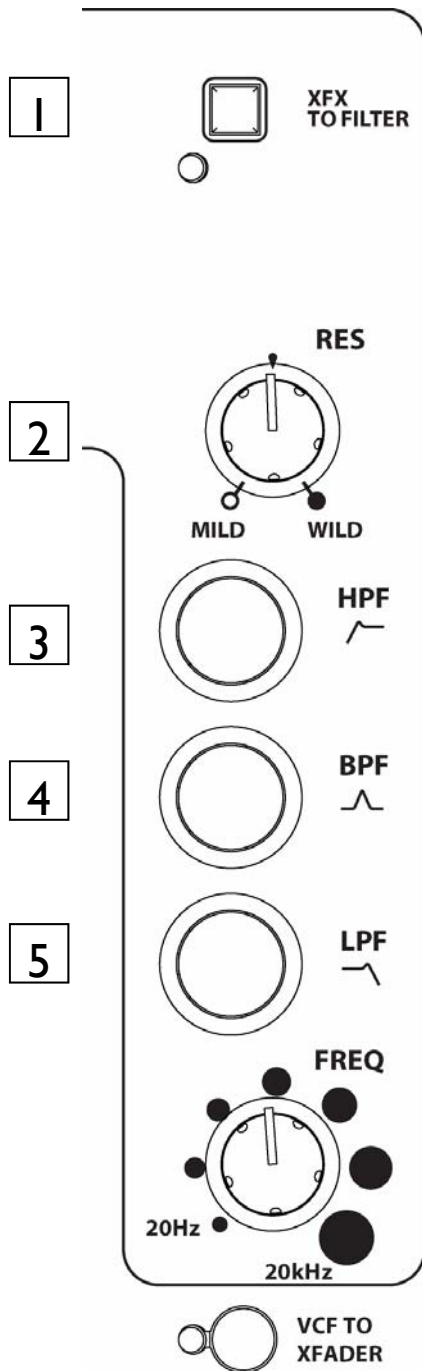

1 X:FX Return to Filter

Pressing this button routes the X:FX return to the VCF filter, instead of directly into the main mix buss. The effected channel signal can then be filtered as well, allowing extra versatility and creativity to be brought into the mix. The blue LED lights to indicate that this function is selected.

2 Resonance Control

This produces the classic analogue VCF sound by feeding some of the filter output back to its input. The control ranges from 'mild' producing a very subtle effect, to 'wild' producing a dramatic phase effect with feedback just short of oscillation.

3 HPF Button

Turns on the high pass (bass cut) filter slope. The light ring around the button illuminates when selected.

4 BPF Button

Turns on the band pass (bell shaped) filter slope. The light ring around the button illuminates when selected.

5 LPF Button

Turns on the low pass (treble cut) filter slope. The light ring around the button illuminates when selected.

FILTER SECTION

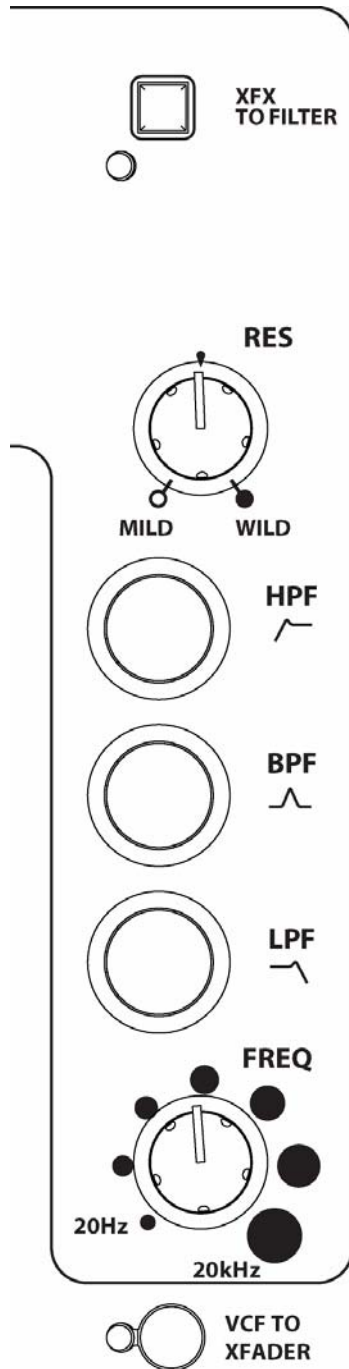

6 Frequency Sweep Control

This control sets the -3dB cut-off frequency of the filter. It ranges from very low frequency (20Hz) to very high frequency (20kHz).

NOTE: Both BPF and HPF filters are band limited to prevent them going above 10kHz.

7 VCF to Crossfader

Press this switch to assign the filter to the crossfader. The crossfader can then be used instead of the **FREQ** VCF sweep control to create filter effects whilst crossfading. The yellow LED next to the switch illuminates to indicate that this control is active.

While using the crossfader to sweep the VCF frequencies, the sweep control ranges from the left-hand (X) side of the crossfader to the mid-point.

Disabling the crossfader will also disable this function.

6

7

HEADPHONE SECTION

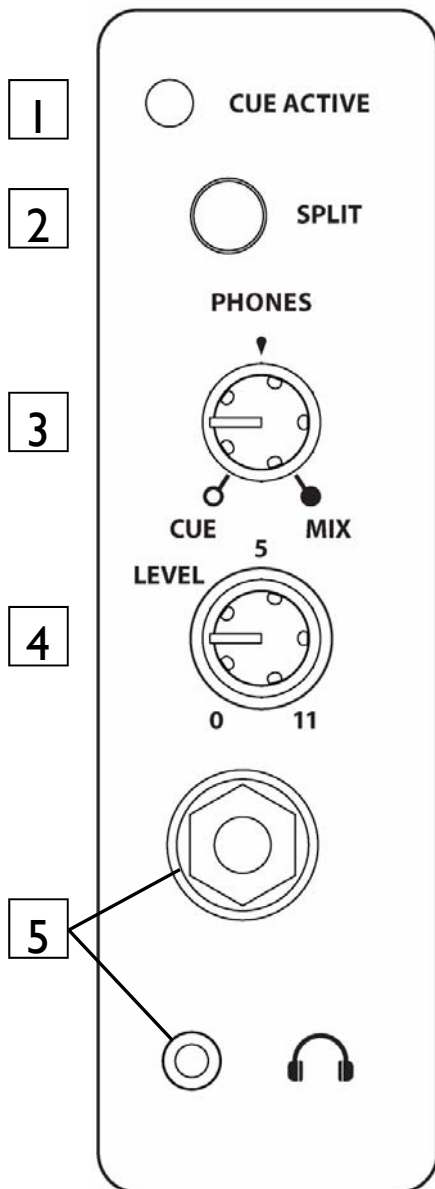

1 Cue Active LED

This LED lights to indicate that one or more of the input and / or mic channels is being monitored in the headphones.

2 Split Cue Switch

Press this switch to change the way Cue operates. Normally, pressing a channel Cue switch overrides both left and right monitor program signals with the stereo cue signal. With the switch pressed, Cue overrides just the left channel leaving the program in the right channel. The left monitor meter displays the cue signal, right displays program. This is very useful when beat mixing using headphones.

3 Cue / Mix Control

Allows the main mix output to be added to the Cue signal. Turned fully anticlockwise, only the active Cue is heard through the headphones when Cue is active. Gradually turning clockwise introduces the main mix output to the headphones, together with the active Cue. Selecting Split Cue will automatically override this control.

4 Headphones Level Control

Adjusts the level of the signal in the stereo headphones. This does not affect the level of the local booth monitor.

5 Headphone Outputs

Stereo 1/4" TRS jack and 3.5mm mini-jack. Plug in good quality stereo headphones intended for DJ monitoring. Use closed-ear headphones that provide maximum acoustic isolation when cueing your sources. We recommend that you use high quality headphones rated between 30 to 100 ohms impedance. 8 ohm headphones are not recommended.

MASTER SECTION

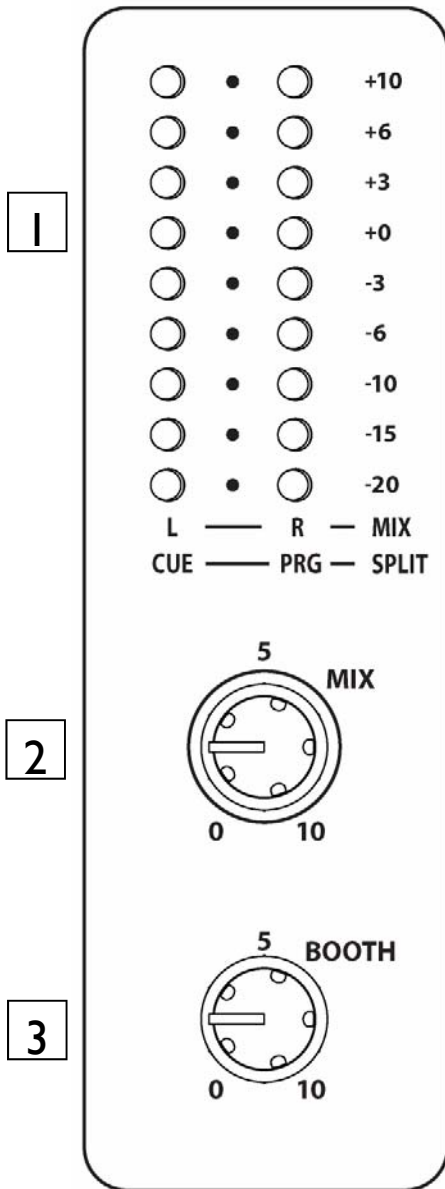

1 Mix / Monitor Meters

The main meters follow the selected monitor source. The default display is the post master level, which is overridden with an input channel level if the channel cue switch is selected.

In split cue mode, the left master meter will display the cued channel signal level and the right master meter will display the mix level. The cued mix audio is pre level to prevent mismatch due to the position of the master level control.

The mixer should be operated with these meters averaging around '0' with loudest peaks no higher than '+6'.

2 Mix Master Level Control

A rotary master control adjusts the level of the main mix XLR outputs feeding the house sound system. This does not affect the booth output or the meter reading.

3 Booth Level Control

Adjusts the level of the signal to the stereo booth RCA output. This does not affect the headphones. The booth output could be used for a booth monitor, recording or an additional zone feed.

CROSSFADER

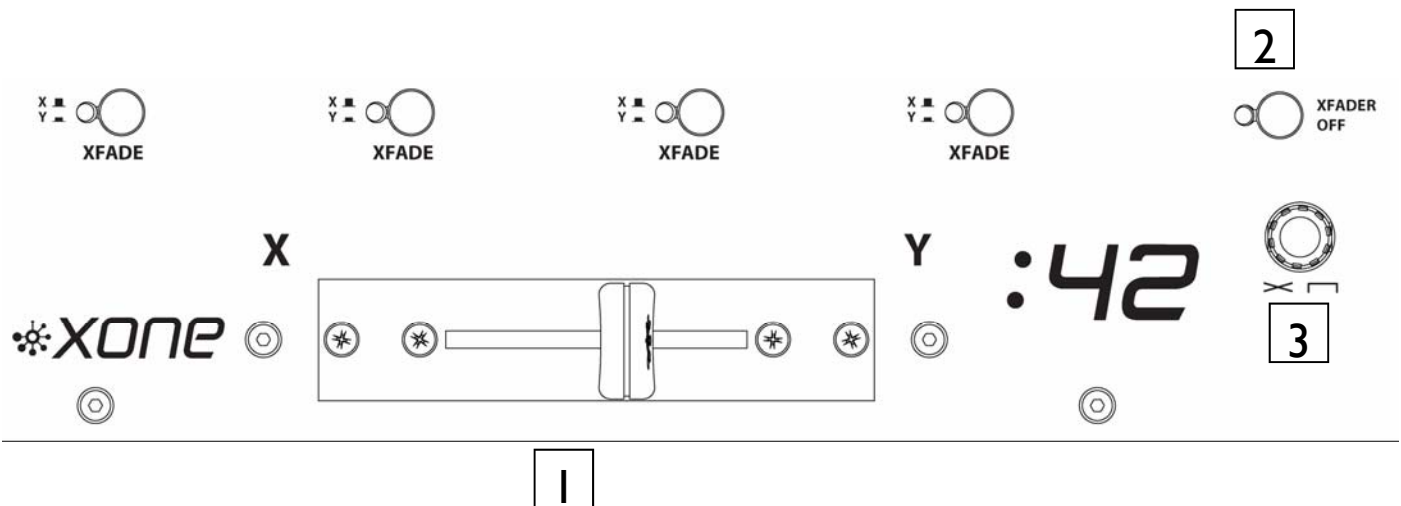

1

Crossfader

This lets you fade between signals routed to either side, typically to fade smoothly into a new music track or to creatively layer sounds when scratch or cut mixing.

The crossfader is a VCA controller which affects the level of signals routed via the filters. Make sure the toggle switches on the channels you wish to fade are set to X or Y as appropriate.

Please contact your Allen and Heath approved service centre for crossfader service or replacement.

2

Crossfader On Switch

In its normal (out) position the crossfader is active. Push the switch to turn the crossfader off—the channel LED indication will also be switched off.

3

Crossfader Curve Control

This control adjusts the crossfader curve between dipped response, ideal for seamless beat mixing, and fast-attack, suitable for scratch or cut mixing.

REAR CONNECTORS

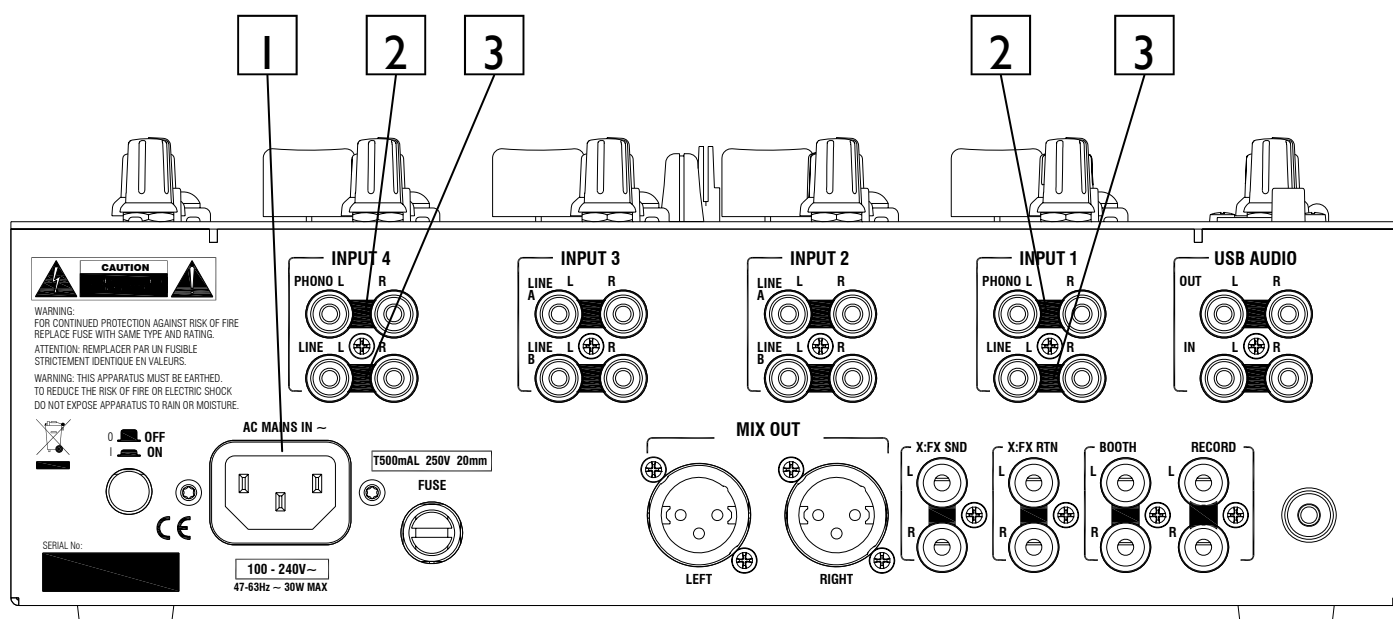

1

AC Mains Input

IEC cable with moulded mains plug suitable for your local supply.

Important: Read the **SAFETY INSTRUCTIONS** sheet included with the Xone:42 and printed on the rear panel.

Check that the correct mains lead with moulded plug has been supplied with your console. The power supply accepts mains voltages within the range 100-240V without changing any fuses or settings. Ensure that the IEC mains plug is pressed fully into the rear panel socket before switching on.

Note: It is standard practice to turn connected power amplifiers down or off before switching the console on or off. This prevents any potential damage to speaker systems due to switch-on transients.

2

CH 1 and 4 Phono Input

RCA phono 7 –100 mV 47K impedance 380 pF. Plug in turntables with magnetic cartridges requiring RIAA equalisation. For non-RIAA turntables plug into the LINE input instead. Do not plug in line level sources to the phono inputs as these will overload the preamp and cause severe high level distortion.

3

CH 1 and 4 Line Input

RCA phono. Connect stereo line level music sources such as CD, MD, DAT, drum machines, keyboards or other instruments. Do not connect turntables which require RIAA equalisation. Alternatively, you can connect to jack sources using a cable with RCA to jack adapters. Avoid using low grade cables such as those often supplied with domestic equipment as these can quickly prove unreliable in use.

REAR CONNECTORS

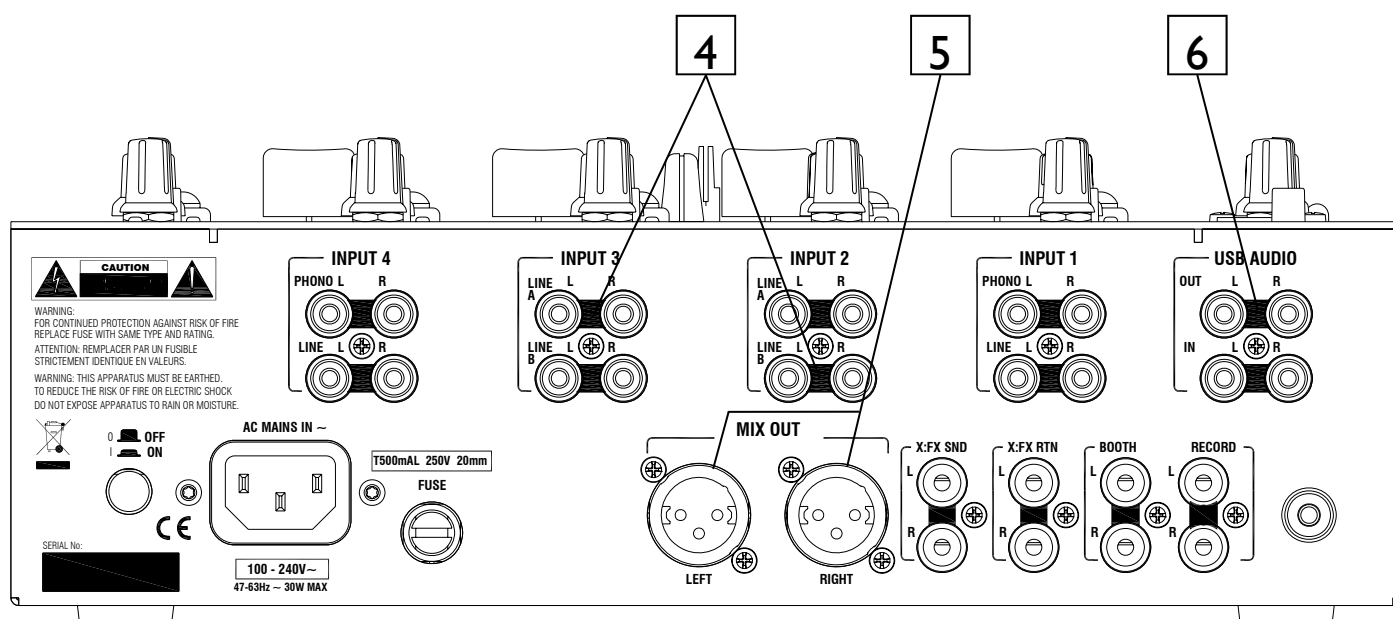

4 CH 2 and 3 Line Inputs A/B

RCA phono. Connect stereo line level music sources such as CD, MD, DAT, drum machines, keyboards or other instruments. Switch between inputs A and B using the switches next to the input levels on the front panel. Do not connect turntables which require RIAA equalisation. Alternatively, you can connect to jack sources using a cable with RCA to jack adapters. Avoid using low grade cables such as those often supplied with domestic equipment as these can quickly prove unreliable in use.

5 Mix Output

Balanced XLR. This is the main output that feeds the house PA system. Plug into the house processor/amplifier system using balanced cables. Use balanced cables and equipment. When the main meter LEDs are at “0dB” the output will nominally be at +4dBu. Do not unbalance this output by shorting one phase to ground—for unbalanced operation use pin 2 only.

6 USB Audio I/O

RCA phono. Allows external connection to USB interface. The routing is configured for external input allowing the USB interface to be connected to the insert point and used as an effects unit with suitable software (such as Ableton Live). To record a mix using the USB In, connect to the Record Out socket.

The USB interface is compatible with Windows™ 98/98SE, ME, WIN2000 and XP, MAC OS9.1, OSX (10.0) or later (but not Japanese OS 10.1).

For lowest latency with Windows, an ASIO driver is recommended such as ASIO4ALL by Michael Tippach — www.asio4all.com

REAR CONNECTORS

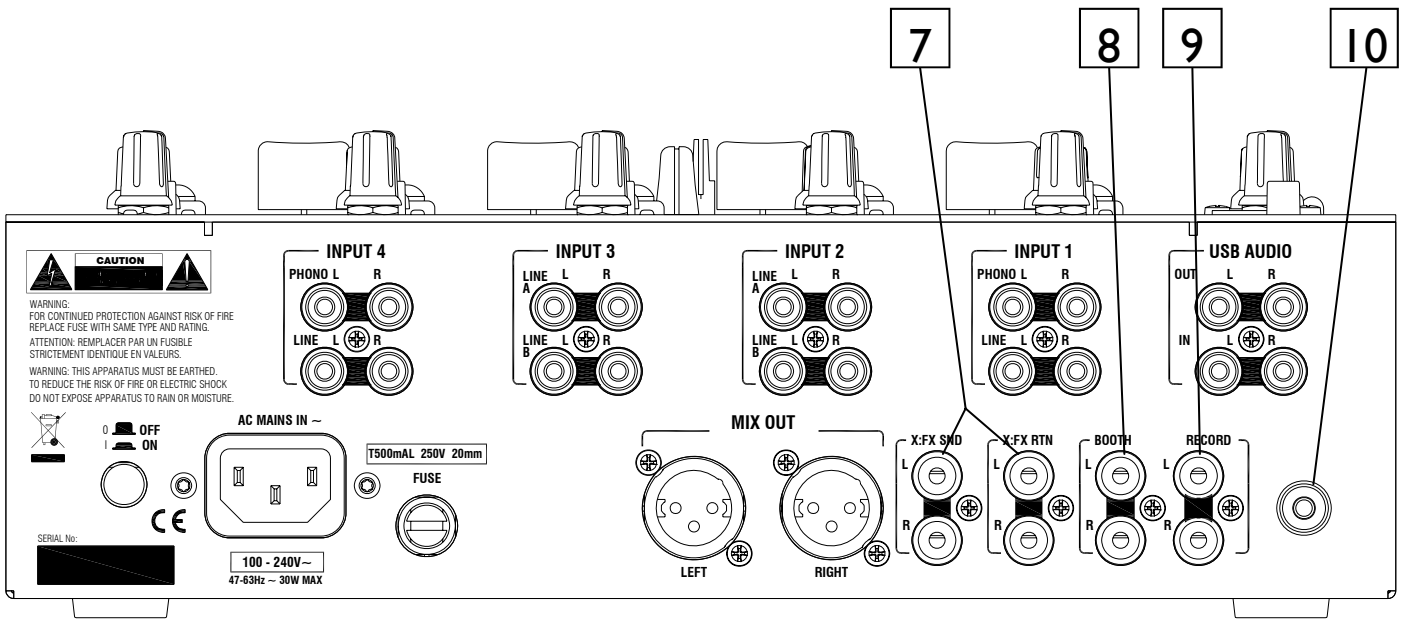

7 X:FX Send/Return

RCA phono. Connect your external effects device and use the X:FX dry / wet control to send channel signals to the effects unit. The signal returns to the mix buss but can be routed to the VCF filter by pressing the 'X:FX Return to Filter' button on the front panel. This allows the filter to be 'stacked' with an external effects device.

8 Booth Output

RCA phono (-2dBu nominal). Provides a line level stereo feed to the DJ local monitor amplifier system. It is not affected by the master fader or cue system.

9 Record Output

RCA Phono, nominal -10dBv (-8dBu). Pre-level mix output for connection to external recording devices.

10 Chassis Earth Terminal

A screw terminal is provided for connecting the earth straps from turntables. This connection earths the metal parts of the turntable to reduce hum, buzz or similar audible noise getting into the system.

USB CONNECTION

The USB interface on the Xone:42 allows connection to a computer for recording, playback, and software-based effects. Remember to always use good quality RCA phono cables to route music signal between devices - sound quality will only be as good as the weakest component in the signal path.

USB for Effects

Connect the X:FX Send to USB In on the left side on the Xone:42's rear panel using RCA phono cables. Using a standard Type A to B USB lead, connect the Xone:42 to your computer's USB port, and start your chosen FX software. You will need to select 'USB Audio CODEC' as the sound playback/recording device if it is not already selected. Connect USB Out to X:FX Return to complete the effects loop. You can then use the X:FX dry / wet controls to send signal from each channel to your computer, as you would with any other external effects hardware.

USB for Playback

Connect your Xone:42 to your computer using a standard Type A to B USB lead. Open your chosen music playback software, ensuring that 'USB Audio CODEC' is selected as the sound playback device. You can now play music from your computer on the Mic / USB channel; ensure that 'USB' is selected using the switch next to the USB port on the Xone:42.

If you wish to apply filter effects, etc. to the music signal from the computer, you can patch the signal into one of the four stereo channels by simply connecting USB Out to one of the channel Line Inputs.

USB for Recording

Connect your Xone:42 to your computer using a standard Type A to B USB lead. Open your chosen music recording software, ensuring that 'USB Audio CODEC' is selected as the sound recording device. You can then send your mix to your computer by connecting Record Out to USB In.

USB Audio Levels

You may find that the USB Audio CODEC volume is too quiet when you first connect your Xone:42. To rectify this, check the device volume in Control Panel\Sounds and Audio Devices:

If the volume is not fully up like this...

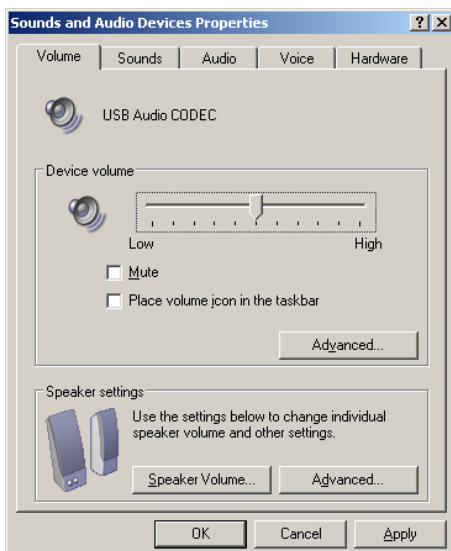

Then drag it fully up like this...

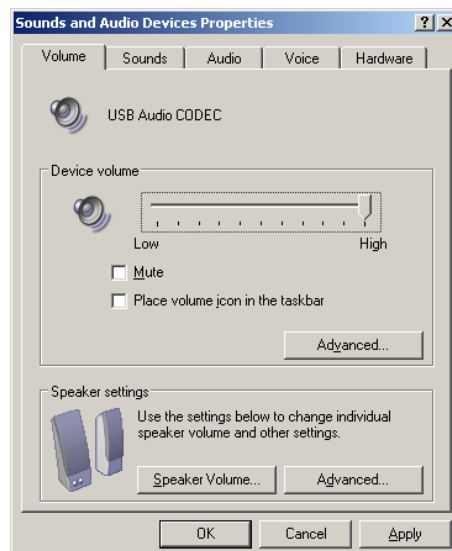

And click **OK**

FILTER REFERENCE

The VCF Filters

A voltage controlled filter is an audio filter where the cut-off frequency is altered by a DC control voltage rather than a variable resistor. This produces a much wider operating range and more control over the filter response to create unlimited combinations of tonal effect.

Filter Type Select

The filters are 'state variable'. This means that they provide three simultaneous filter types: high-pass, band-pass and low-pass. Three large illuminated switches select which type is active. You can press any combination together to create different response types such as 'notch' and an interesting 'all-pass' effect. The switches are 'soft switched' for live performance, meaning that the audio signal is ramped between filter states to prevent audible clicks.

Note that the last selected type is lost when power is removed from the console. The LPF is always selected when power is applied.

The graphs below show the effect on the audio frequency response for the three filter types. The range of sweep from low to high frequency is shown together with the effect of adjusting RESONANCE (one frequency with several resonance settings shown).

The vertical scale shows the amount of cut or boost around the normal 0dB operating level. The horizontal scale shows the change in frequency from low (bass) to high (treble).

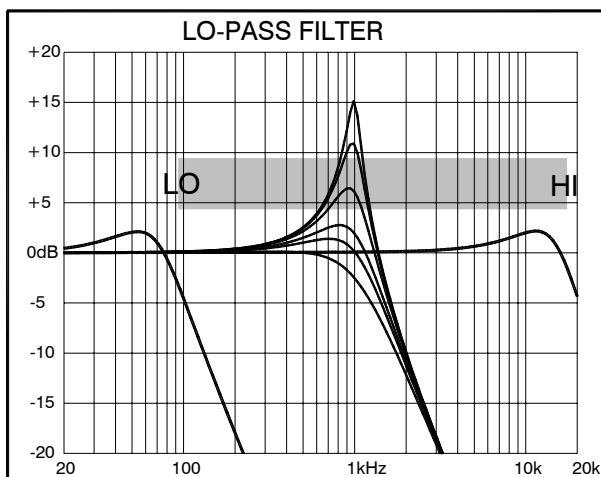
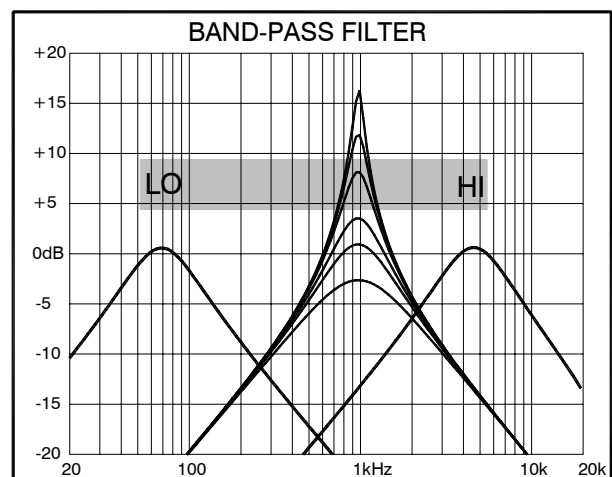
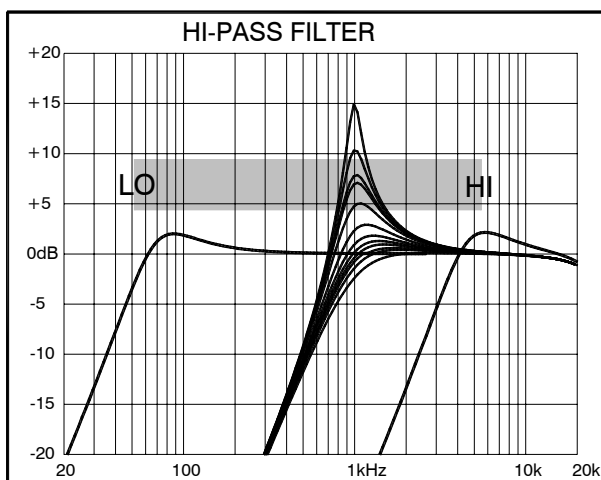

OPERATING LEVELS

It is most important that the system level settings are correctly set. It is well known that many DJs push the level to maximum with meters peaking hard in the belief that they are getting the best from the system. **THIS IS NOT THE CASE !** The best can only be achieved if the system levels are set within the normal operating range and not allowed to peak. Peaking simply results in signal distortion, not more volume. It is the specification of the amplifier / speaker system that sets the maximum volume that can be achieved, not the console. The human ear too can fool the operator into believing that more volume is needed. Be careful as this is in fact a warning that hearing damage will result if high listening levels are maintained. Remember that it is the **QUALITY** of the sound that pleases the ear, not the **VOLUME**.

The diagram below illustrates the operating range of the audio signal.

NORMAL OPERATING RANGE. For normal music the signal should range between -6 and $+6$ on the meters with average around 0 dB. This allows enough **HEADROOM** for unexpected peaks before the signal hits its maximum **CLIPPING** voltage and distorts.

It also achieves the best **SIGNAL-TO-NOISE-RATIO** by keeping the signal well above the residual **NOISE FLOOR** (system hiss).

The **DYNAMIC RANGE** is the maximum signal swing available between the residual noise floor and clipping.

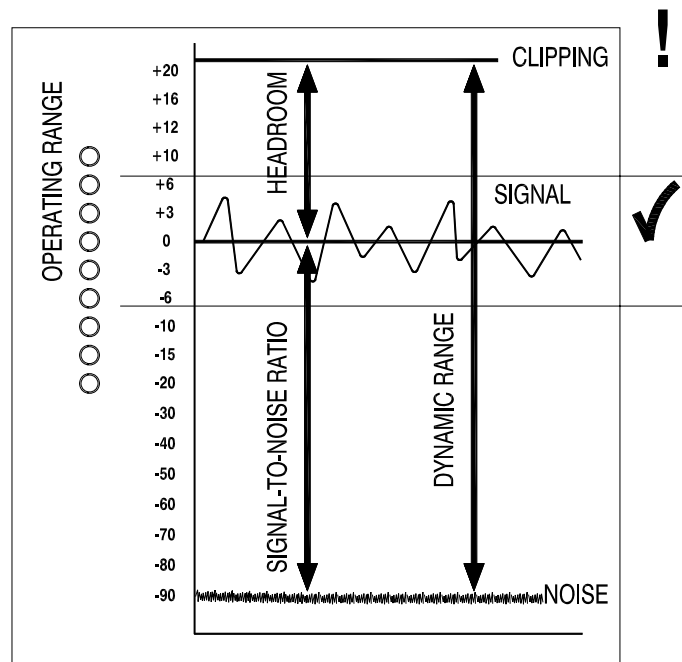

An important note ...

The human ear is a remarkable organ with the ability to compress or 'shut down' when sound levels become too high. Do not interpret this natural response as a reason to turn the system volume up further ! As the session wears on ear fatigue may set in, and the speaker cones may become hot so reducing the effectiveness of the system and listeners to gain any benefit from increased volume.

EARTHING

The connection to earth (ground) in an audio system is important for two reasons:



SAFETY - To protect the operator from high voltage electric shock, and

AUDIO PERFORMANCE - To minimise the effect of earth (ground) loops which result in audible hum and buzz, and to shield the audio signals from interference.

For safety it is important that all equipment earths are connected to mains earth so that exposed metal parts are prevented from carrying high voltage which can injure or even kill the operator. It is recommended that a qualified system engineer check the continuity of the safety earth from all points in the system including microphone bodies, turntable chassis, equipment cases, and so on.

The same earth is also used to shield audio cables from external interference such as the hum fields associated with power transformers, lighting dimmer buzz, and computer radiation. Problems arise when the signal sees more than one path to mains earth. An 'earth loop' (ground loop) results causing current to flow between the different earth paths. This condition is usually detected as a mains frequency audible hum or buzz.

To ensure safe and trouble-free operation we recommend the following:

Have your mains system checked by a qualified electrician. If the supply earthing is solid to start with you are less likely to experience problems.

Do not remove the earth connection from the console mains plug. The console chassis is connected to mains earth through the power cable to ensure your safety. Audio 0V is connected to the console chassis internally. If problems are encountered with earth loops operate the audio 'ground lift' switches on connected equipment accordingly, or disconnect the cable screens at one end, usually at the destination.

Make sure that turntables are correctly earthed. A chassis earth terminal is provided on the console rear panel to connect to turntable earth straps.

Use low impedance sources such as microphones and line level equipment rated at 200 ohms or less to reduce susceptibility to interference. The console outputs are designed to operate at very low impedance to minimise interference problems.

Use balanced connections for microphones and mix output as these provide further immunity by cancelling out interference that may be picked up on long cable runs. To connect an unbalanced source to a balanced console input, link the cold input (XLR pin 3 or jack ring) to 0V earth (XLR pin 1 or jack sleeve) at the console. To connect a balanced XLR output to unbalanced equipment, link the cold output to 0V earth at the console.

Use good quality cables and connectors and check for correct wiring and reliable solder joints. Allow sufficient cable loop to prevent damage through stretching.

If you are not sure ... Contact your service agent or local Allen & Heath dealer for advice.

REPLACING THE CROSSFADER / FACE PLATE

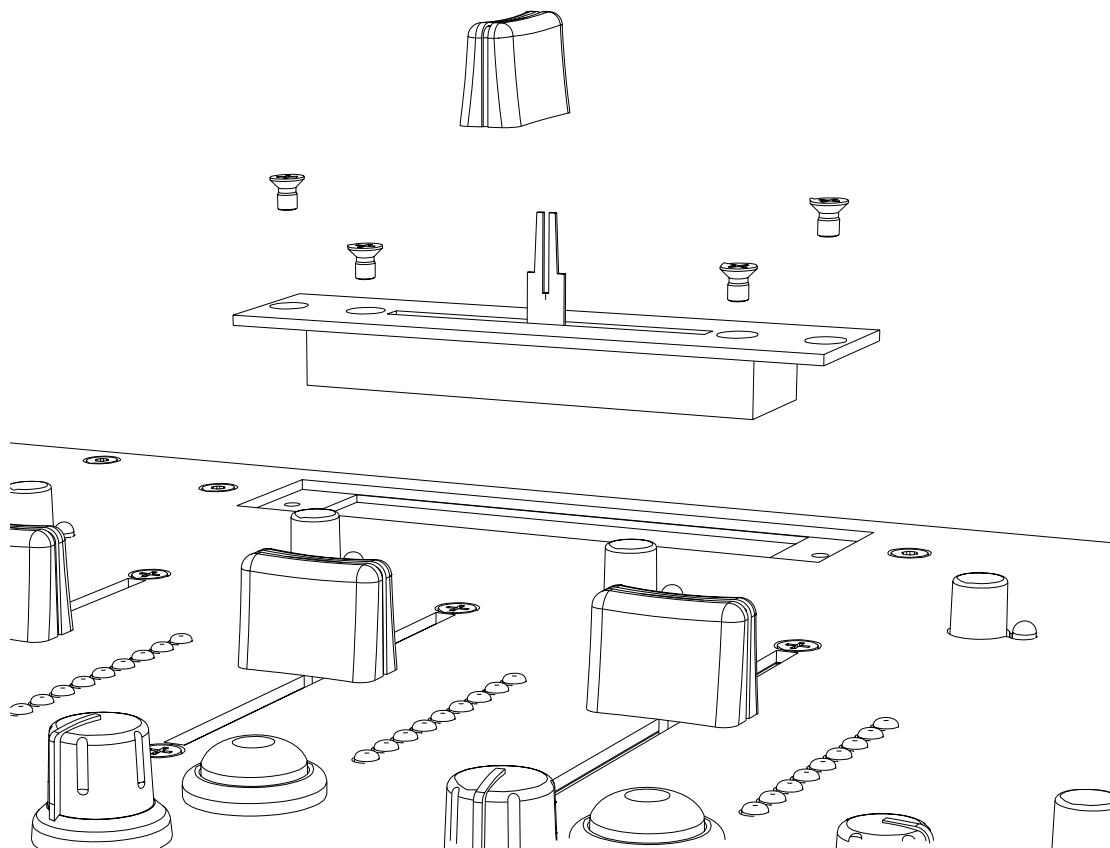

Replacing the Crossfader

- Firstly, pull the crossfader cap vertically off the fader shaft and put it somewhere sensible.
- Use a medium size cross-point screwdriver to undo and remove the two outer screws on the crossfader plate.
- Carefully pull the crossfader assembly away from the front panel.
- Unplug the cable from the old crossfader, and once the crossfader assembly is detached, unscrew the two inner screws to separate the fader from the plate.
- Fit the new crossfader, put the inner screws back in, and re-connect the cable.
- Check that the connector is correctly aligned and pushed on.
- Replace the assembly making sure the cable faces the right-hand side of the console.
- Refit the outer screws and test operation.

Standard Alpha Crossfader Part Number— 003-829 JIT

Penny & Giles Crossfader Option Part Number— 002-719 JIT

USER-REPLACEABLE PARTS

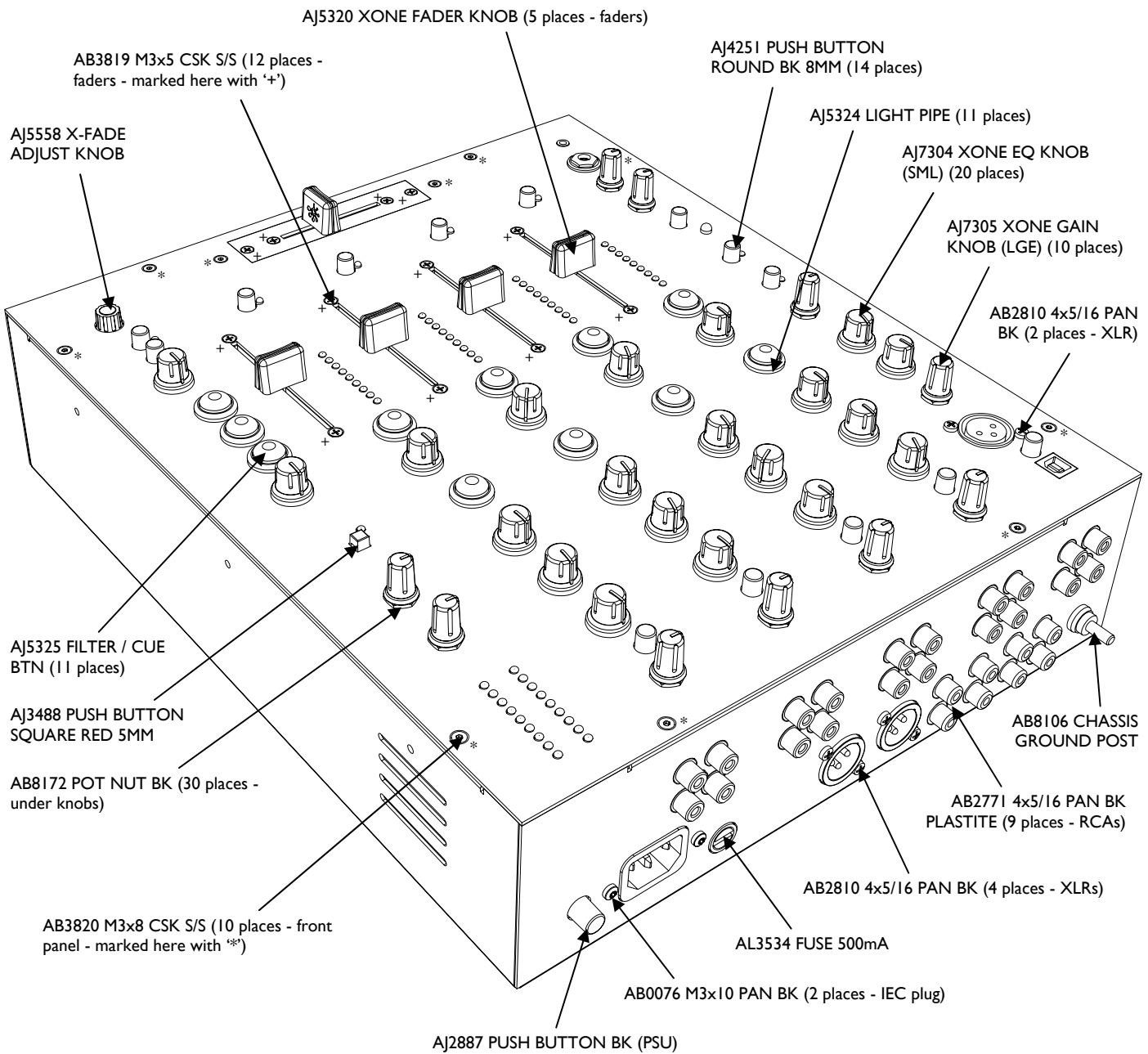

The diagram above shows all of the replacement parts that can be ordered from your local technical support, or direct from Allen & Heath, for the Xone:42. When ordering please quote the part number(s) of the required parts - this makes life easier for us!

Note: Key for front panel screws

Screws marked with '*' on the above diagram are the M3x8 stainless steel countersunk type, which require a T10 'Torx' screwdriver. Screws marked with '+' are the shorter M3x5 stainless steel countersunk fader screws, which require a medium size cross-point screwdriver.

See the previous page for information on replacing the crossfader, and for replacement cross-fader assembly numbers.

Check out the website:

www.xone.co.uk

... for products, news, reviews, user forum, downloads, galleries, merchandise, and **much more** ...