



# Vaddio™ WallVIEW™ D80 PTZ and WallVIEW™ D90 PTZ Camera Systems

Wall Mounted Pan/Tilt/Zoom Camera Systems using Vaddio's EZCamera™ Cabling System

## Part Numbers:

### WallVIEW D90 PTZ

999-2694-000 - NTSC - Black  
999-2694-000W - NTSC - White

999-2694-001 - PAL - Black  
999-2694-001W - PAL - White



### WallVIEW D80 PTZ

999-2684-000 - NTSC - Black  
999-2684-000W - NTSC - White

999-2684-001 - PAL - Black  
999-2684-001W - PAL - White



## Table of Contents

- Overview: ..... 3
  - Important Safeguards: ..... 3
  - Intended Use..... 3
  - Save These Instructions ..... 3
  - Information: ..... 3
- Unpacking: ..... 4
  - Four (4) WallVIEW D90 PTZ Systems ..... 4
  - Four (4) WallVIEW D80 PTZ Systems ..... 4
- Installation: ..... 5
  - Before Installation: ..... 5
    - Diagram: The Basic Idea ..... 5
    - Diagram: Daisy Chain Control Configurations ..... 6
- Step by Step Mounting and Install Instructions: ..... 6
  - Step 1: Determine the Camera Mount Location: ..... 6
  - Step 2: Determine the preferred Method of Wall Mounting ..... 6
    - Image: PCBA inside the Shoe ..... 7
    - Image: Attaching the Shoe ..... 7
  - Step 4: Attach the Camera and Shoe to the Wall Mount: ..... 7
    - Image: Camera, Shoe and Mount ..... 7
- Finishing the Install: ..... 8
  - Final Step: ..... 8
  - Documents and Information ..... 8
- Warranty Information: ..... 9
- Appendix 1: ..... 10
  - Vaddio Power, Video and Control Pin-outs ..... 10
    - Image: The EZCamera Cable Shoe ..... 10
    - Table/Diagram: Power/Video Connection, RJ-45 Pin-outs 568B ..... 10
    - Table/Diagram: RS-232 IN Connection, RJ-45 Pin-outs ..... 10
    - Table/Diagram: RS-232 OUT Connection for Daisy Chain Support, RJ-45 Pin-outs ..... 11
    - Image: Quick-Connect Box ..... 11
    - Table/Diagram: Power/Video Connection, RJ-45 on Quick-Connect Box ..... 11

**Overview:**

The Vaddio WallVIEW D80 PTZ and WallVIEW D90 PTZ are a complete wall mounted Pan/Tilt/Zoom camera systems supporting the standard definition Sony® EVI-D80 (white and black models) and the EVI-D90 (black and white models).

The systems include a Sony PTZ Camera (EVI D80 with an 18X optical zoom or EVI D90 with a 28X optical zoom), a Thin Profile Wall Mount for the camera and a Vaddio EZCamera™ Cabling System. The EZCamera Cabling System allows the installer to use two (2) Cat-5 cables to run power, video and control up to 200' (60.96m).

Also included are Vaddio's PowerRite™ Power Supply and the EZCamera Cable Shoe, which regulates the right amount of power needed for the camera over Cat-5 cabling. The Shoe is connected to the Quick-Connect Box via Cat-5 for a power and video break out at the head-end and a DE-9 F to RJ-45F EZCamera Control Adapter is included to adapt an RS-232 controller or control systems to Cat-5 cabling and there are a number of control adapters available for specific applications.

The cameras, EVI-D80 and EVI-D90 have a built-in D70 control mode that makes these camera systems compatible with any controller (for example: ProductionVIEW FX, ProductionVIEW HD and ProductionVIEW Precision Camera Controller) right out of the shoot making these WallVIEW system immediately available for a wide range of standard definition shooting applications.



WallVIEW D90 PTZ - Black Camera System Shown with Mount and EZCamera Shoe

**Important Safeguards:**

Read and understand all instructions and warranty statements before using. Do not operate any device if it has been dropped or damaged. In this case, a Vaddio technician must examine the product before operating. To reduce the risk of electric shock, do not immerse in water or other liquids and avoid extremely humid conditions.



**General Safeguard:** Use only the power supply provided with the system. Use of any unauthorized power supply will void any and all warranties. Please do not cut the secondary side (or the DC side) of the power supply and attempt to extend the power to the camera. The warranty is voided when the cable is cut.



Please do not use "pass-thru" type RJ-45 connectors. These pass-thru type connectors do not work well for professional installations and can be the cause of intermittent connections which, can result in the RS-232 control line failing and locking up, and/or compromising the HSDS™ signals. For best results please use standard RJ-45 connectors and test all cables for proper pin-outs prior to use and connection to Vaddio product.

**Intended Use**

Before operating the device, please read the entire manual thoroughly. The system was designed, built and tested for use indoors, and with the provided power supply and cabling. The use of a power supply other than the one provided or outdoor operation has not been tested and could damage the device and/or create a potentially unsafe operating condition.

**Save These Instructions**

The information contained in this manual will help you install and operate your product. If these instructions are misplaced, Vaddio keeps copies of Specifications, Installation and User Guides and most pertinent product drawings for the Vaddio product line on the Vaddio website. These documents can be downloaded from [www.vaddio.com](http://www.vaddio.com) free of charge.

**Information:**

For RS-232 control information, please see the full-length Technical Manuals for the Sony EVI-D80 and EVI-D90. This manual can be found either on the Sony or the Vaddio website.

## Unpacking:

Carefully remove the device(s) and all parts from the packaging. Please do not toss the packaging yet, just set it aside where it won't be in the way. Unpack and identify the following parts:

All of the WallVIEW Systems will have the following set of peripherals and it shall be known as "The Peripheral Set", otherwise there will be many pages of duplication, which may prove rather bothersome.

The "Peripheral Set" contains the following gear:

- One (1) EZCamera Cabling Shoe 998-2280-000 (white or black - camera dependent)
- One (1) Quick-Connect Box 998-1105-001
- One (1) PowerRite 18 VDC, 2.75 Amp Power Supply
- One (1) EZCamera Control Adapter 998-1001-232
- NTSC Units - One (1) North American Power Cord
- PAL Units - One (1) Euro and One (1) UK Power Cords
- One (1) Thin Profile Wall Mount 535-2000-236 with Mounting Hardware
- One 12' (3.66m) S-Video Cable
- One 12' (3.66m) Composite Video Cable
- Sony IR Remote Control
- Documentation (Vaddio Manual and Sony Manual)



Not all items shown

## Four (4) WallVIEW D90 PTZ Systems

### 999-2694-000 - NTSC - Black

- One (1) Sony EVI-D90N - Black, NTSC Camera
- One Peripheral Set with North American Power Cord, Black Mount and Shoe

### 999-2694-000W - NTSC - White

- One (1) Sony EVI-D90N/W - White, NTSC Camera
- One Peripheral Set with North American Power Cord, White Mount and Shoe

### 999-2694-001 - PAL - Black

- One (1) Sony EVI-D90P - Black, PAL Camera
- One Peripheral Set with Euro and UK Power Cords, Black Mount and Shoe

### 999-2694-001W - PAL - White

- One (1) Sony EVI-D90P/W - White, PAL Camera
- One Peripheral Set with Euro and UK Power Cords, White Mount and Shoe

## Four (4) WallVIEW D80 PTZ Systems

### 999-2684-000 - NTSC - Black

- One (1) Sony EVI-D80N - Black, NTSC Camera
- One Peripheral Set with North American Power Cord, Black Mount and Shoe

### 999-2684-000W - NTSC - White

- One (1) Sony EVI-D80N/W - White, NTSC Camera
- One Peripheral Set with North American Power Cord, White Mount and Shoe

### 999-2684-001 - PAL - Black

- One (1) Sony EVI-D80P - Black, PAL Camera
- One Peripheral Set with Euro and UK Power Cords, Black Mount and Shoe

### 999-2684-001W - PAL - White

- One (1) Sony EVI-D80P/W - White, PAL Camera
- One Peripheral Set with Euro and UK Power Cords, White Mount and Shoe

### Installation:

The WallVIEW products are cameras specifically designed for installation on a vertical wall surface with Cat-5 cable connectivity for Power, Video and Control signaling. Installation is simplified in that no custom 8-Pin mini-din cables or expensive S-Video plenum cables are needed and no power outlets are required near the camera bracket. All cabling is routed to the head-end using Cat-5 cabling with the EZCamera Cabling system.



**Note:** The WallVIEW D80 PTZ and the WallVIEW D90 PTZ can be located 200' (61m) from the Quick-Connect Box with power supply at the head end.

### Before Installation:

- Locate the camera mounting location paying close attention to camera viewing angles, lighting conditions, possible line of site obstructions while also checking for in-wall obstructions where the camera is to be mounted.
- The WallVIEW D80 PTZ and WallVIEW D90 PTZ can be mounted to standard 2-gang wall boxes. All cameras are basically lightweight and the thin profile wall mount bracket can be adequately secured to the wall with the four (4) provided spiral wall anchors (or your own choice of dry wall anchor).
- Pick a mounting location to optimize the performance of the camera



Pre-wire all cabling as required, mark and test the cables (see wiring diagram examples). Please do not connect to the EZ Camera Cable Shoe using the "guess/trial and error" method. Plugging the EZ POWER/VIDEO Cat. 5 Cable into the wrong RJ-45 may cause damage to the camera and void the warranty!

### Diagram: The Basic Idea (no scale)

The WallVIEW D90 PTZ uses a single Cat-5 for 18 VDC Power and Video to the Quick-Connect Box. A second Cat-5 cable is used for RS-232 control (shown connected to a Vaddio ProductionVIEW HD Switcher/mixer/controller).

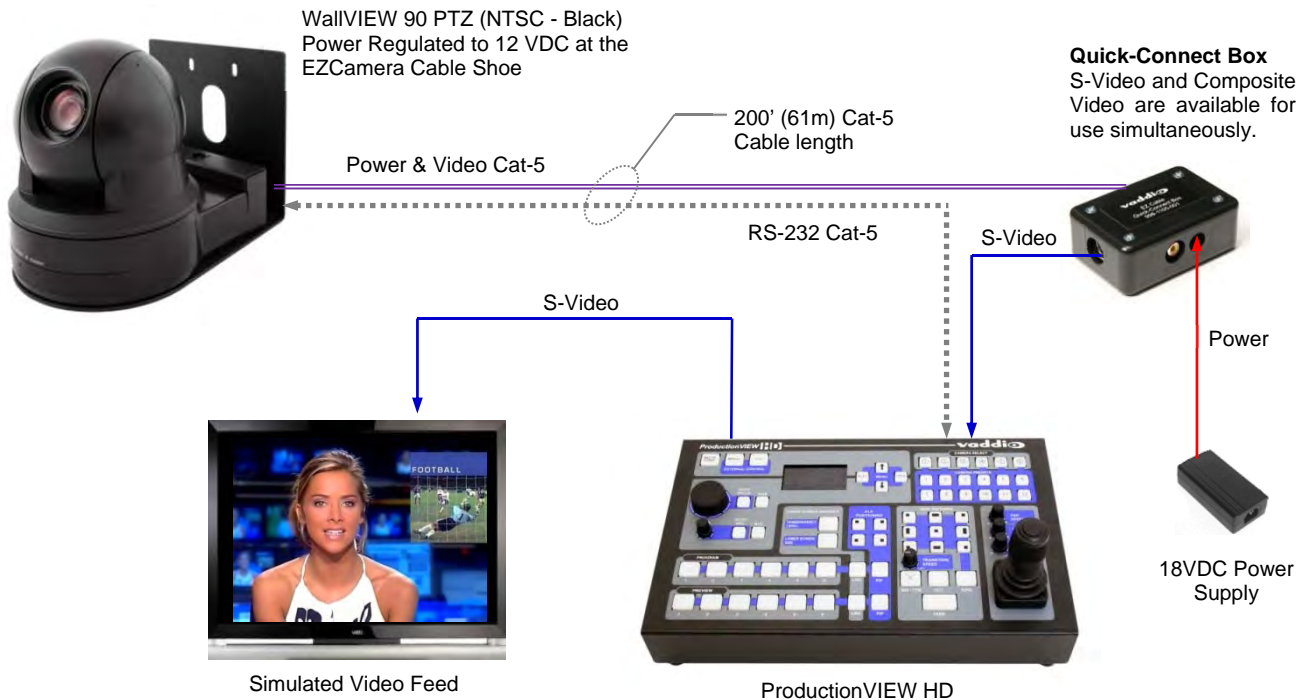

**Diagram: Daisy Chain Control Configurations**

The WallVIEW D80 PTZ and WallVIEW D90 PTZ are capable of supporting a daisy chain control configuration using a non-Vaddio controller (Sony Joystick or correctly written Crestron or AMX program). Vaddio controllers support only direct connect, star wiring configurations for control because daisy chaining introduces another level of fault (Murphy’s Law) that makes for some tricky, time consuming system troubleshooting. However, there is more than one way to configure systems and while Vaddio whole-heartedly recommends a one to one star configuration for control, the WallVIEW with the EZCamera Cabling Shoe also support daisy chain systems. The Shoe has a RS-232 IN and a RS-232 OUT to support daisy chaining. See diagram below:

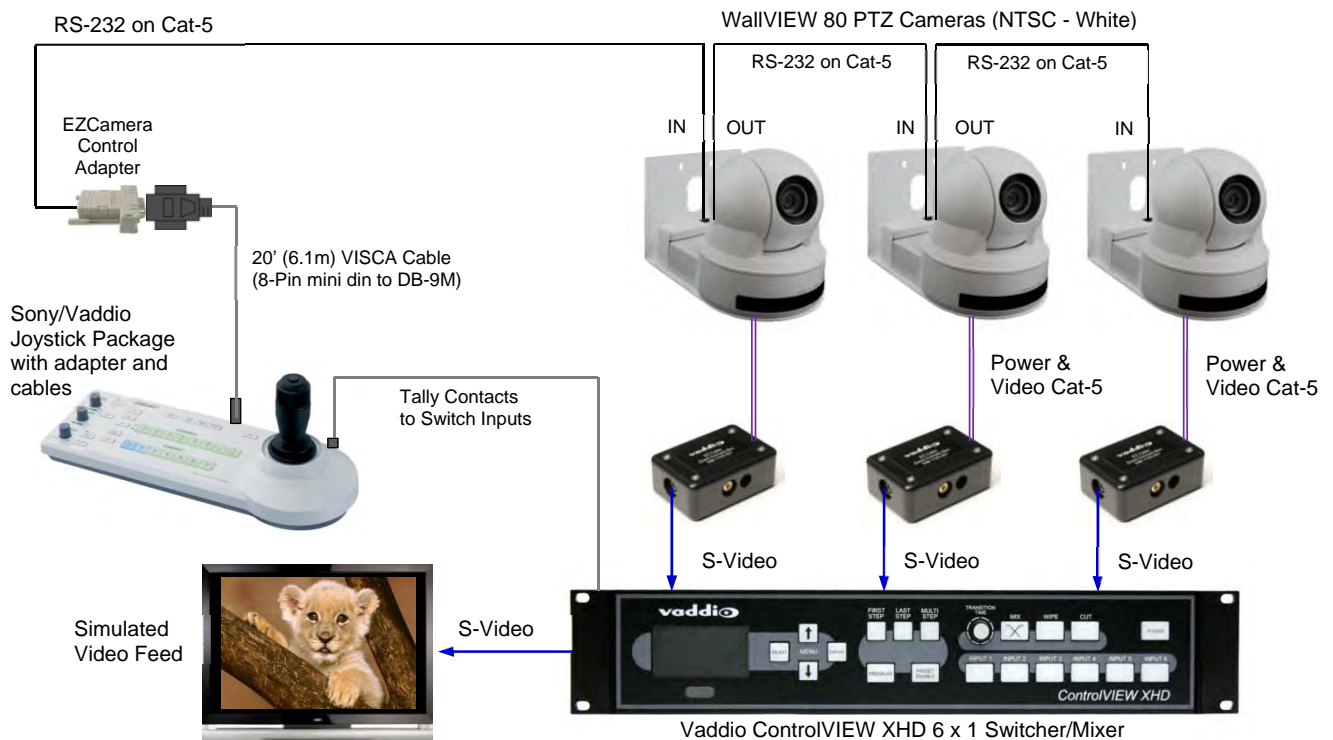

Note: In the diagram above a video switcher/mixer is required because the control had to be separated from the switcher/mixer in order to accommodate the daisy chain control configuration.

**Step by Step Mounting and Install Instructions:**



**Step 1: Determine the Camera Mount Location:**

When locating the camera, consider viewing angles, lighting conditions, possible line of site obstructions and check for in-wall obstructions where the camera is to be mounted. Select a mounting location to optimize the performance of the camera for your application.

After determining the optimum location of the camera system, route the required Cat-5 cables from the camera location to the head-end. Be sure to mark the cables and leave several inches of Cat-5 extending out from the wall for ease of connection.

**Step 2: Determine the preferred Method of Wall Mounting**

- Method 1:** If the bracket is to be mounted on a 2-gang wall box, use the screws supplied with the wall box cover plate to attach the Thin Profile wall mount bracket.
- Method 2:** If the bracket is to be mounted to the dry wall, then use the provided spiral wall anchors or other wall anchors of integrator’s choice. Mount the wall mount to the anchors with the supplied #8 sheet metal screws. The mounting holes are opposed 90° so leveling is easy...but use a level anyway, otherwise the result may be that funky Batman camera angle.



**Step 3: Attach the Vaddio EZ Camera Shoe to the camera**

Carefully attach the Vaddio EZCamera Shoe to the back connector plate of the camera using the Power pin and the composite video RCA as guide pins.

**Image: PCBA inside the Shoe**

Pins from left to Right: Power (EIAJ-04), two (2) 8-pin Mini Din males, S-Video (4-pin Mini Din male) & Video RCA-M

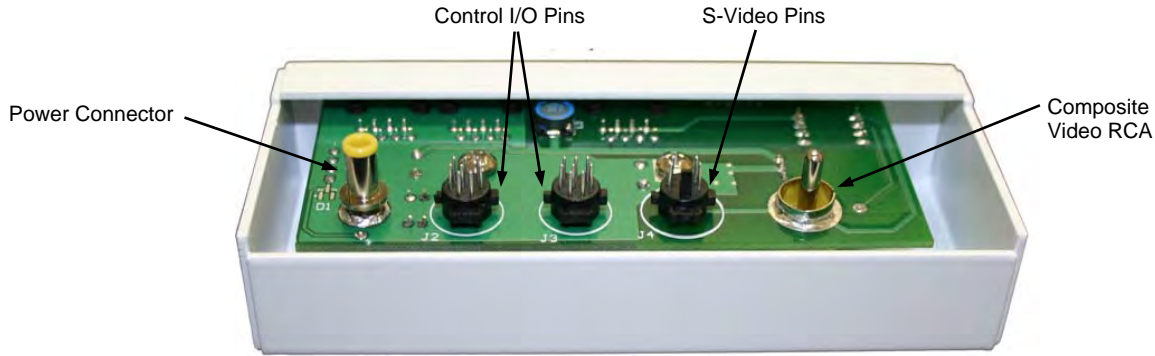

**Image: Attaching the Shoe**

WallVIEW D80 PTZ - White shown with EZCamera Cable Shoe. Carefully slide the shoe into place taking care to seat the male connections firmly into place.



Do not force the shoe onto the connectors. It should slide into place and make positive connection with a minimum of effort.

Press into place, Do Not Force the Shoe onto the camera



WallVIEW 80 PTZ and Shoe Shown

**Step 4: Attach the Camera and Shoe to the Wall Mount:**

Place the camera onto the camera mount and plug in the Cat-5, RJ-45 connectors. Insert and loosely tighten the supplied 1/4"-20 screw through the wall mount slot and secure the camera to the mount. Gently push camera toward the front of the mount and align with front curve of mount, then tighten bottom screw. Feed the excess cable into the wall or wall box.

**Image: Camera, Shoe and Mount**

Insert the 1/4"-20 mounting screw through bottom slot and tighten down the camera loosely



WallVIEW 80 PTZ, Shoe & Mount Shown

Position camera on the mount so it looks "sweet" and tighten the mounting screw

## Finishing the Install:

### Final Step:

Please check all Cat-5 cables for continuity in advance to final connection. This will save hours of trouble shooting time.

- Attach the Cat. 5 cable for Power and Video to the Quick-Connect Box. Use the supplied Video cables and plug these cables from the Quick-Connect Box to the video destination (codec, monitor, projector, switcher/mixer etc...).
- Connect the PowerRite power supply to the Quick-Connect Box power input.
- Verify all connections.
- Connect only the Vaddio supplied power supply to an AC outlet. Power will travel down the Cat-5 cable to the shoe, which regulates and supplies 12 VDC to the camera. The camera will “Home” to a centered position ready for control information from the provided Vaddio IR Remote Commander or RS-232 camera controller of the integrators’ choice.

### Documents and Information

For documents on video, power and control pin-outs, please see the Vaddio website under Tech Center, General Technical Notes, WallVIEW Video, Power and Control Pin-Outs Technical or the Appendix at the back of this manual.

For RS-232 control information, please see the full-length manuals for each of the manufacturer’s camera models (Sony EVI-D80 or Sony EVI-D90) either on the Sony website or the Vaddio website [www.vaddio.com](http://www.vaddio.com).

Vaddio has prepared a number of Tech Notes, specifications and drawings designed to inform and educate integrators’ of the value and the specific uses of Vaddio products.

For general specifications on the Sony EVI-D80 and EVI-D90 cameras please see the Sony manuals that are shipped with each camera.

For compliance testing information, please see Sony manuals for FCC and CE testing results and warnings.



## Warranty Information:

(See Vaddio Warranty, Service and Return Policies posted on [vaddio.com](http://vaddio.com) for complete details):

**Hardware\* Warranty:** One year limited warranty on all parts. Vaddio warrants this product against defects in materials and workmanship for a period of one year from the day of purchase from Vaddio. If Vaddio receives notice of such defects during the warranty period, they will, at their option, repair or replace products that prove to be defective. Please see Vaddio's Service Terms and Conditions at [vaddio.com](http://vaddio.com) for specific details and policies.

**Exclusions:** The above warranty shall not apply to defects resulting from: improper or inadequate maintenance by the customer, customer applied software or interfacing, unauthorized modifications or misuse, operation outside the normal environmental specifications for the product, use of the incorrect power supply, improper extension of the power supply cable or improper site operation and maintenance.

**Vaddio Customer Service:** Vaddio will test, repair, or replace the product or products without charge if the unit is under warranty and is found to be defective. If the product is out of warranty, Vaddio will test then repair the product or products. The cost of parts and labor charge will be estimated by a technician and confirmed by the customer prior to repair. All components must be returned for testing as a complete unit. Vaddio will not accept responsibility for shipment after it has left the premises.

**Vaddio Technical Support:** Vaddio technicians will determine and discuss with the customer the criteria for repair costs and/or replacement. Vaddio Technical Support can be contacted through one of the following resources: e-mail support at [support@vaddio.com](mailto:support@vaddio.com) or online at [www.vaddio.com](http://www.vaddio.com).

**Return Material Authorization (RMA) Number:** Before returning a product for repair or replacement, request an RMA from Vaddio's technical support. Provide a technician with a return phone number, e-mail address, shipping address, and product serial numbers and describe the reason for repairs or returns as well as the date of purchase and proof of purchase. Include your assigned RMA number in all correspondence with Vaddio. Write your assigned RMA number on the outside of the box when returning the product. All products returned for credit is subject to a restocking charge without exception.

**Voided Warranty:** The warranty does not apply if the original serial number has been removed or if the product has been disassembled or damaged through misuse, accident, modifications, or unauthorized repair. Cutting the power supply cable on the secondary side (low voltage side) to extend the power to the device (camera or controller) voids the warranty for that device.

**Shipping and Handling:** Vaddio will not pay for inbound shipping transportation or insurance charges or accept any responsibility for laws and ordinances from inbound transit. Vaddio will pay for outbound shipping, transportation, and insurance charges for all items under warranty but will not assume responsibility for loss and/or damage by the outbound freight carrier.

• If the return shipment appears damaged, retain the original boxes and packing material for inspection by the carrier. Contact your carrier immediately.

**Products Not Under Warranty:** Payment arrangements are required before outbound shipment for all out of warranty products.

\*Vaddio manufactures its hardware products from parts and components that are new or equivalent to new in accordance with industry standard practices.

## Other General Information:

### Care and Cleaning

Do not attempt to take this product apart at any time. There are no user-serviceable components inside.

- Do not spill liquids in the product
- Keep this device away from food and liquid
- For smears or smudges on the product, wipe with a clean, soft cloth
- Use a quality lens cleaner on any lens
- Do not use any abrasive chemicals.

### Operating and Storage Conditions:

Do not store or operate the device under the following conditions:

- Temperatures above 40°C (104°F) or temperatures below 0°C (32°F)
- High humidity, condensing, wet environments and hotel swimming pools
- In inclement weather
- Dusty environments with lots of snakes and lizards
- Dry environments with an excess of static discharge
- Under severe vibration

### Appendix 1:

#### Vaddio Power, Video and Control Pin-outs

For Vaddio Cameras: WallVIEW D80 PTZ and WallVIEW D90 PTZ

**Image: The EZCamera Cable Shoe** P/N: 998-2280-000

Dimensions (W x H x D): 4.875" (123.83mm) x 2" (50.8mm) x 1.125" (28.575mm)



**Table/Diagram: Power/Video Connection, RJ-45 Pin-outs 568B**

- Tab down Pins 1 through 8, Left to right

Pin #	Function	Pairs
Pin - 1	Power +	1
Pin - 2	Power GND	1
Pin - 3	Video GND	2
Pin - 4	Y (Luminance)	3
Pin - 5	Video GND	3
Pin - 6	C (Chrominance)	2
Pin - 7	Video GND	4
Pin - 8	Composite Video (CVBS)	4

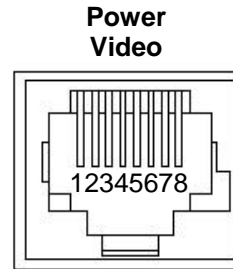

Tab down Pins 1 through 8, Left to right 568B

**Table/Diagram: RS-232 IN Connection, RJ-45 Pin-outs**

Pin #	Function	Pairs
Pin - 1	DTR (Sony Daisy chain to DSR)	1
Pin - 2	DSR (Sony Daisy chain from DTR)	1
Pin - 3	CTS (Canon Daisy chain to RTS)	Not Used
Pin - 4	RTS (Canon Daisy chain from CTS)	Not Used
Pin - 5	N/A	Not Used
Pin - 6	Digital GND	
Pin - 7	RXD (from TXD of control source)	4
Pin - 8	TXD (to RXD of control source)	4

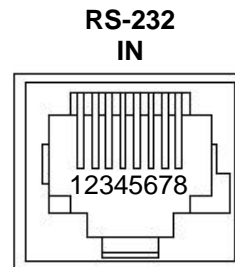

**Table/Diagram: RS-232 OUT Connection for Daisy Chain Support, RJ-45 Pin-outs**

Pin #	Function	Pairs
Pin - 1	DSR (Sony Daisy chain from DTR)	1
Pin - 2	DTR (Sony Daisy chain from DSR)	1
Pin - 3	RTS (Canon Daisy chain to CTS)	Not Used
Pin - 4	CTS (Canon Daisy chain from RTS)	Not Used
Pin - 5	N/A	Not Used
Pin - 6	Digital GND	
Pin - 7	TXD (to RXD of control source)	4
Pin - 8	RXD (from TXD of control source)	4

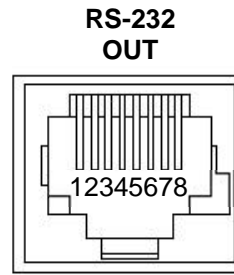

**Image: Quick-Connect Box**

Dimensions (W x H x D): 3" (761.2 mm) x 2" (50.8mm) x 1." (25.4mm)



**Table/Diagram: Power/Video Connection, RJ-45 on Quick-Connect Box**

Pin #	Function	Pairs
Pin - 1	Power +	1
Pin - 2	Power GND	1
Pin - 3	Video GND	2
Pin - 4	Y (Luminance)	3
Pin - 5	Video GND	3
Pin - 6	C (Chrominance)	2
Pin - 7	Video GND	4
Pin - 8	Composite Video (CVBS)	4

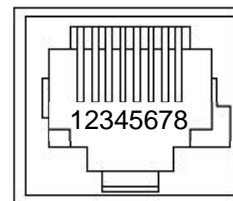



Toll Free: 800-572-2011 ▪ Phone: 763-971-4400 ▪ FAX: 763-971-4464

[www.vaddio.com](http://www.vaddio.com)