

User Guide

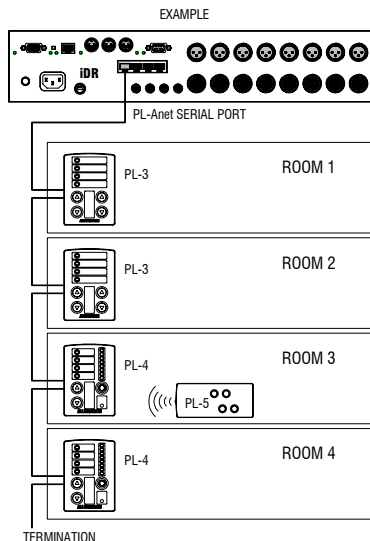

Introduction The **PL-3** is one of several remote control devices available for the **iDR** audio mix processor system. It is part of the Allen & Heath **PL Series** of wall plates and remote controllers. It is a wall plate or furniture mounted module comprising plastic control panel and attached circuit assembly. It can be mounted in a single unit wall box using a standard face plate (UK, EU or US version supplied). A suitable template with cutting details is provided for custom application. The **PL-3** interfaces with the Allen & Heath RS485 based PL-Anet serial port. Multiple **PL-3** units can be daisy chained together along with other PL-Anet devices using CAT5 cable. For information on the full range of **PL** products available visit <http://www.allen-heath.com>. The wall plate control and indicator functions are programmed using the **iDR** System Manager software. Space is provided on the control panel for custom labelling of the programmed functions. The following combination of controls makes the **PL-3** ideal as a wall mounted room remote controller in installed audio systems. The installer can program the unit so that the non-technical operator has local control of volume, mute, source select, and preset changes which reconfigure the room for different functions.



4 switches can be assigned for level up or down control (input, output, crosspoint or group), mute toggle, polarity toggle, audio monitor select, or preset recall.

4 LED indicators can be assigned as audio meters (choice of 8 points in the signal path), mute status, polarity status, or as preset related static display. They can display four states: off, green, yellow or red.

Custom labels Recessed areas are provided for fitting custom adhesive labels. Recommended maximum sizes are 6x26mm and 26x9mm.

Number of devices The maximum number of **PL** devices that can be connected depends on their type and the cable lengths. Up to 15x **PL-3** devices may be connected to the PL-Anet port, or up to 24x if you are using the optional **PL-9** PL-Anet hub. Fewer devices may be connected if long distances or other **PL** types are also involved. To check this refer to the PL Combinations Calculator spreadsheet available from the Allen & Heath web site.

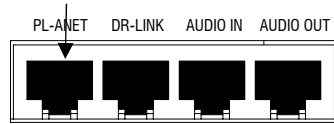

CAUTION 20V DC
TO AVOID DAMAGE ONLY CONNECT COMPATIBLE REMOTE CONTROL EQUIPMENT TO THE PL-ANET PORT.

PL-Anet is the proprietary Allen & Heath system for daisy chaining remote controllers. It is an RS485 serial connection that uses CAT5 STP cable to communicate between devices over long distances. PL-Anet only works with Allen & Heath **PL** devices. The connection includes +20V DC to power the connected devices. The **iDR-8** port is shown here.



This product complies with the European Electromagnetic Compatibility directives 89/336/EEC & 92/31/EEC.

NOTE: Any changes or modifications to the equipment not approved by Allen & Heath could void the compliance of the equipment. Whilst we believe the information in this guide to be reliable we do not assume responsibility for inaccuracies. We also reserve the right to make changes in the interest of further product development.

Copyright© 2008 Allen & Heath Ltd. All rights reserved.

IMPORTANT :

Observe the local standards which may apply to the installation regarding the grade of cable and installation methods.

To ensure operator safety ensure that any exposed metal face plates are correctly bonded to ground. Do not install the equipment where it is subject to moisture, heat or vibration.

Connect this equipment to the Allen & Heath PL-Anet port only. Test for correct wiring and installation before switching the equipment on.

Aligning the arrow keys The two switch caps can be rotated so that the arrow faces up, down, left or right. Decide which way you want them to face according to function, for example volume or source select.

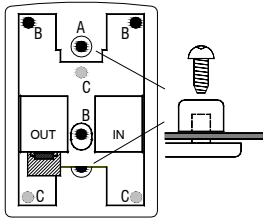

To change them, first remove the three screws (B) and unplug the top PCB. Remove the three screws (C) and lift the lower PCB away. Rotate the switch caps into the required position. Reassemble the module taking care to correctly align the inter-PCB connector.

Mounting into the face plate A pre-cut brushed aluminium UK (part number AA5029), EU (AA5250) or US (AA5030) plate is supplied. A backing box for the UK plate can be ordered (AA5220).

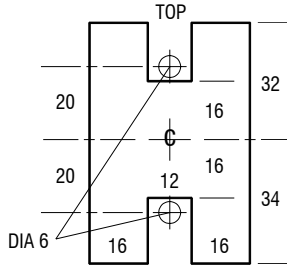

The assembled module fits into an 'H' shaped cutout in the centre of the mounting plate. The module is held using the two screws with plastic clamps provided (A). Unscrew these from the module first. Dimensions are in millimetres below.



Grounding a metal plate

If the face plate is metal ensure that it is correctly grounded to ensure operator safety. The plate should be connected to a local safety ground, not the PL-Anet screen connection. Use a ground wire or physical contact with a grounded back box.



Wiring standards Use flame retardant CAT5 STP (shielded twisted pair) cable. The connection follows the EIA/TIA 568B wiring colour scheme. Ensure all ports and cables in the system are wired to this scheme. The RJ45 connector wiring is shown here.

1	WH/OR	[Yellow/White]
2	OR	[Yellow]
3	WH/GN	[Green/White]
4	BL	[Blue]
5	WH/BL	[Blue/White]
6	GN	[Green]
7	WH/BN	[Brown/White]
8	BN	[Brown]

PL-Anet connection – early version

Screw terminal blocks are provided for the serial port IN and OUT connections on early version PL-3 modules. Use a small flat bladed screwdriver. Ensure the wires are correctly stripped and formed to allow sufficient service loop in the backing box. Note that some wires are twisted together in the same terminal.

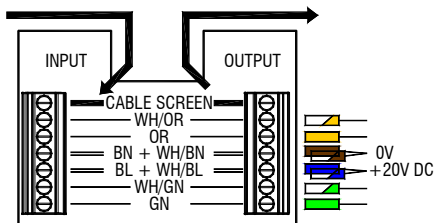

PL-Anet connection – later version

RJ45 sockets are provided for the serial port IN and OUT connections on more recent PL-3 modules. Use unbooted plugs to ensure the cables can fit into the backing box. Use a small bladed screwdriver to lever up the plug retaining clips when unplugging the cables if the clips are against the circuit card.

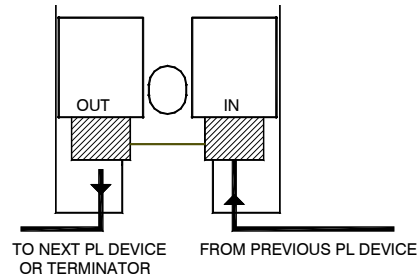

End of chain termination

As with any RS485 system, the last PL device needs to have a terminating resistor fitted to its output port. Early version PL-3 modules are shipped with a 100 ohm resistor already fitted. Leave this fitted only if the unit is the last in the chain. Later version PL-3 modules are supplied with a terminating RJ45 plug (Allen & Heath part number 003-082).

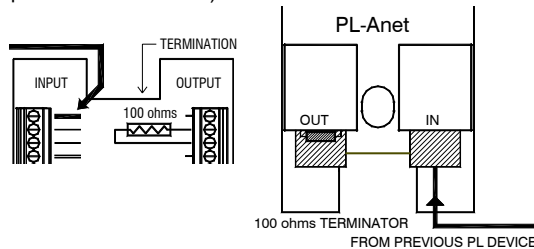

Connection to the iDR

The PL-Anet network plugs into the iDR unit using an RJ45 connector. This is wired to the 568B scheme. The PL-Anet port provides the RS485 serial communication and +20V DC power to the chain of PL modules. The device addresses are automatically allocated per type in the order they appear in the PL-Anet chain.



Testing the wiring

Before powering up the system make sure all the wiring is inspected and continuity tested. This is important as wiring errors may result in damage to the equipment.

Powering up the PL system

Ensure that the iDR PL-Anet port is active. Its green 'active' LED should be lit. If not, use the iDR System Manager software Communications Option menu to activate the port. Plug in the PL-Anet cable. The iDR System Manager screen should display icons on the right hand toolbar for each PL device it recognises. Refer to the Help file for details on programming the PL functions.

Diagnostics

If a fault is suspected check the two diagnostics LEDs on the underside of the PL-3 connector PCB. Both the red and green LEDs should be lit once communication with the iDR is established. Also measure the PL-Anet +20V supply feed between the blue wires (+20V) and the brown wires (0V). For reliable operation this voltage should not drop below +11V with all PL LED displays turned on. If a fault is found, first check for correct wiring. If further assistance is required contact Allen & Heath technical support.